

# 1.7.1 Filtri Nafta

Fuel Filters



## Ricambi & accessori per macchine agricole

SPARE PARTS & ACCESSORIES FOR AGRICULTURAL MACHINE

Tutti gli articoli della presente sezione, prodotti da AMA SPA e/o da terzi per conto di AMA, sono adattabili ("non originali") alle marche indicate ai sensi di quanto previsto dal REG. CE n. 1400/2002. I diritti sui marchi citati appartengono ai legittimi proprietari ed il loro uso ha l'esclusiva finalità di consentire all'utilizzatore la comparazione dei diversi prodotti. All items of this section, manufactured by AMA SPA and/or any third party on behalf of AMA, are adaptable ("non-original") to the brands listed under the provisions of the REG. CE n. 1400/2002. The rights on the trademarks belong to their respective owners and their usage is only aimed to allow the user to compare different products.

**FILTRI NAFTA ADATTABILI**

FILTRE A GAZOLE ADAPTABLE

FUEL FILTERS ADAPTABLE

KRAFTSTOFF FILTER PASSEND ZU

FILTRO GASOIL ADAPTABLE

Art./Ref.	Brand	Applicazione/Application	Rif. Orig./Orig. Ref.	Immagine/Image
<b>02042</b>	<b>CASE</b>	2500SP-3000SP IRRORATRICE, 4391-4391T-4391TA-6991T-6591TA, 8825-8825HP ANDANATRICE SEMOV., 8860-8860HP ANDANATRICE SEMOV., 8870 ANDANATRICE SEMOVENTE, 8880-8880HP ANDANATRICE SEMOV., MX100-MX110-MX120-MX135, MX150-MX170, SPX3200-SX3200B IRRORATRICE	J931062	
<b>02042</b>	<b>DEUTZ</b>	Agrostar DX4.61, DX4.71, D10006, D13006, D9006, DX110, DX120, DX140, DX145, DX160, DX230, DX250, DX3.10 bis, DX3.90, DX4.10 bis, DX4.70, DX6.10, DX6.30, DX6.50, DX7.10, DX8.30, DX80, DX85, DX86, DX90, DX92, Intrac 2005, Intrac 2006, Intrac 6.30 Turbo	01174482	
<b>02058</b>		DIAMOND, EXPLORER, EXPLORER COM 3, EXPLORER T-TB COM 3, IRON, IRON COM 3, IRON CONTINUO, IRON HI-LINE, IRON HI-LINE COM 3, SILVER	01180597	
<b>26518</b>		D2506, D3006, D3607, D3607 A, DX.36 V	01161341, 01174696, Q05H4117	
<b>02042</b>	<b>FIAT</b>	955C, F100, F100DT, F110, F110DT, F115, F115DT, F120, F120DT, F130, F130DT, F140, F140DT, SERIE 55 95.55C, SERIE 65 55.65C, SERIE 65 60.65C, SERIE 66 55.66/VF, SERIE 66 56.66S, SERIE 66 60.66/LP, SERIE 66 55.66, SERIE 66 60.66, SERIE 66 45.66, SERIE 66 55.66/LP, SERIE 66 50.66, SERIE 75 55.75C, SERIE 75 60.75C, SERIE 76 45.76/V, SERIE 76 60.76/F, SERIE 85 55.85C, SERIE 85 60.85C, SERIE 85 62.85C, SERIE 86 70.86/V, SERIE 86 72.86/LP-F, SERIE 86 82.86/LP-F, SERIE 86 50.86/V, SERIE 86 55.86/VF, SERIE 86 60.86/VF, SERIE 86 62.86/F, SERIE 88 55.88, SERIE 88 60.88, SERIE 90 110.90, SERIE 90 100.90, SERIE 90 90.90, SERIE 93 60.93, SERIE 94 60.94, SERIE G G170, SERIE G G190, SERIE G G210, SERIE G G240	1909142, 1930010, 47135706, 4753103, 4814454, 79075882, 87800220, 87840509	
<b>02043</b>		100C, 120C, 1300 - 1300S DT, 130C, 1355C, 150C, 1580 - 1580 DT, 160-90, 160-90 DT, 180, 180-90, 180-90 DT, 1880 - 1880DT, 200C, 60CA, 650 - 650DT - 655C, 655C, 750 - 750N - 750SOM - 750C, 80R, 850 - 850DT - 850SPECIAL, SERIE 50 OM	1909103, 4964322	
<b>02058</b>		35.66, 35.66DT	1930820, 1930891, 9963446	
<b>02731</b>		3300 MIETITREBBIA LAVERDA, 3300AL MIETITREBBIA LAVERDA, 3300R MIETITREBBIA LAVERDA, 3400 MIETITREBBIA LAVERDA, 3400R MIETITREBBIA LAVERDA, 3500 MIETITREBBIA LAVERDA, 3500AL MIETITREBBIA LAVERDA, 3500R MIETITREBBIA LAVERDA, 3550R MIETITREBBIA LAVERDA, 355C, 3650 MIETITREBBIA LAVERDA, 3650R MIETITREBBIA LAVERDA, 3750 MIETITREBBIA LAVERDA, 3750R MIETITREBBIA LAVERDA, 455C, 465C, 465C/V/F, 505c, 555c, 565c, 605c, 765c, 805c, 80C, 855c, 90C, L517 MIETITREBBIA LAVERDA, SERIE 55 85.55.00, SERIE 65 80.65C, SERIE 65 60.65C, SERIE 65 70.65C, SERIE 66 65.66, SERIE 66 80.66, SERIE 66 80.66/F, SERIE 66 55.66, SERIE 66 60.66, SERIE 66 70.66, SERIE 66 70.66/LP-F, SERIE 66 55.66/LP, SERIE 75 70.75C, SERIE 75 80.75C, SERIE 76 70.76/LP-VF, SERIE 76 80.76/F, SERIE 85 88.85C, SERIE 85 72.85C, SERIE 85 82.85C, SERIE 88 70.88, SERIE 88 80.88, SERIE 90 115.90, SERIE 90 70.90, SERIE 90 85.90, SERIE 90 140.90, SERIE 90 55.90, SERIE 90 60.90, SERIE 90 65.90, SERIE 90 130.90, SERIE 90 80.90, SERIE 93 72.93, SERIE 93 88.93, SERIE 93 65.93, SERIE 93 82.93, SERIE 94 82.94, SERIE 94 88.94, SERIE 94 65.94, SERIE 94 72.94	1901687, 1909100, 4621740, 4651986, 4669551, 4669556, 4680444, 4787696, 70251397, 84535312, 9918114, 9924318	

Art./Ref.	Brand	Applicazione/Application	Rif. Orig./Orig. Ref.	Immagine/Image
02742	FIAT	555C - 655C TERNA GOMMATA, 555D - 575D - 655D TERNA GOMMA	1930277	
08251		400, 411, 415	1160217, 1909108, 1909113, 1930749, 572880, 582042, 79043896	
15400		160-90, 160-90 DT, 180-90, 180-90 DT	1909107, 4788504	
15401		125CA - CI, 200C, 60CA, 615 - 715, OM512 - OM513, SERIE 140 - 140CA - 140CI, SERIE 50 OM, SERIE 55, SERIE 60C - 60CI - 60CT, SERIE 70CI - 70R - 80CA - 80R	1909109, 9901486	
15402		211 - 241 - 321, 211R - 215R - 220 - 220C, 311C-312C-315C-331RS, 332C-332RS-342-351C-352C, 60CA, SERIE 18-24, SERIE 25-25R, SERIE 315 DIAMANTE, SERIE 60C - 60CI - 60CT, SERIE 70CI - 70R - 80CA - 80R	1909112, 970269	
15406		100-55 CINGOLATO, 100-90, 100-90DT, 110-90, 110-90DT, 115-90, 115-90DT, 130-90, 130-90DT, 140-90, 140-90DT, 160-90, 160-90DT, 180-90, 180-90DT, 55-56, 55-56DT, 55-66, 55-66DT, 55-66S, 55-66S DT, 55-88, 55-88DT, 55-90, 55-90DT, 60-56DT, 60-66, 60-66DT, 60-66S, 60-66S DT, 60-75 CINGOLATO, 60-75M CINGOLATO, 60-88, 60-88DT, 60-90, 60-90DT, 60-93, 60-93DT, 60-94, 60-94DT, 62-85 CINGOLATO, 62-85M CINGOLATO, 65-56, 65-56DT, 65-66, 65-66DT, 65-66S, 65-66S DT, 65-88, 65-88DT, 65-90, 65-90DT, 65-93, 65-93DT, 65-94, 65-94DT, 70-56, 70-56DT, 70-66, 70-66DT, 70-66S, 70-66S DT, 70-75 CINGOLATO, 70-75M CINGOLATO, 70-88, 70-88DT, 70-90, 70-90DT, 72-85 CINGOLATO, 72-85M CINGOLATO, 72-93, 72-93DT, 72-94, 72-94DT, 80-66, 80-66DT, 80-66DT CINGOLATO, 80-66S, 80-66S DT, 80-75 CINGOLATO, 80-88, 80-88DT, 80-90, 80-90DT, 80-93DT, 82-85M CINGOLATO, 82-93, 82-93DT, 82-94, 82-94DT, 85-90, 85-90DT, 88-85M CINGOLATO, 88-93, 88-94, 88-94DT, 90-90, 90-90DT, F100, F100DT, F110, F110DT, F115, F115DT, F120, F120DT, F130, F130DT, F140, F140DT	1930581	
02042	FENDT	10S, 11S, 12S, 303 bis, 307LSA, 307, 308, 308LSA FWA 178/26, 309, 309LSA, 310, 310LSA, 311, 311LSA, 312, 312LSA, 345GT, 360GT, 360GTH, 365GTA, 380GHA, 380GT, 380GTA, 600LSA, 610LSA, 611LSA, 612LSA, 614LSA, 615LSA, 822 Turbo, 824 Turbo	F180201060030	
02731		108LSA, 108S, 200S, 201S, 203V, 204P, 205P, 240S, 250SA, 250VA, 275VA, 280PA	F278201060040	
08251		1 FL237, 2 FW139/3, 230GT, 2E 139/1,3, 2S FW138/11, 2S FWA138/7, 3S FW238/1, 3S FWA238/7, 4S FWA 258, 8115L	F015200060180	

Art./Ref.	Brand	Applicazione/Application	Rif. Orig./Orig. Ref.	Immagine/Image
26518	FENDT	200V-200K-203V-203K-204V-204P, 205P-203P-203P11-203VII, 240-250V-250VA-260P-260PA, 260V-260VA-270P-270PA, 270V-270VA-280P-280PA, FARMER 102-102S-102SA, FARMER 103-103S-103LS-103LSA, FARMER 104S-104LS-104LSA-104SA, FARMER 105-105SA, FARMER 105S-105LS, FARMER 106S TURBO MATIC, FARMER 108S-108LS, FARMER 200-200SA-201S-201SA, FARMER 240S-250S-260S-275S, FARMER 25 EXPORT, FARMER 3S, FAVORIT 3	F138204060020, F138204060080	
02042	FORD	3010S-4010S-5010S, 3435, 3830, 3935, 4030, 4135, 4230, 4430	1930010, 87800220, 87840509	
02043		8630, 8830	1909103	
02731		2000 BSD 326, 2310 BSD 326, 2600 BSD 326, 2610>01.81 BSD 329, 2610>01.82 BSD 329, 2810 BSD 326, 2910 BSD 329, 3000 BSD 329, 3055 BSD 331, 3230 BSD 332, 3430 BSD 332, 3435 8035.06, 3600 BSD 329, 3610>01.81 BSD 332, 3610>01.82 BSD 332, 3900 BSD 332, 3910 BSD 332, 3910 H BSD 332, 3930 BSD 333, 3930 H BSD 332, 3935 8035.06, 4000 BSD 333, 4100 BSD 331, 4110>01.81 BSD 333H, 4110>01.82 BSD 333H, 4130 BSD 333, 4130 H BSD 333, 4135 8035.06, 4330 BSD 333, 4600 BSD 333H, 4610 H BSD 333, 4610>01.81 BSD 333H, 4610>01.82 BSD 333H, 4630 BSD 333H, 4635 L60 8035.05, 4830 BSD 442, 4835 L65 8045.06, 5000 4/68< BSD 442, 5000 <3/68 BSD 348, 5030 BSD 442, 5110 BSD 444, 550 BSD 333H, 555 BSD 333H, 555 A BSD 333, 555 B BSD 333, 555 C BSD 444, 5600 10/80< BSD 444, 5600<09/80 BSD 442, 5610 BSD 444, 5635 L75 8045.06, 5640 P.S. 4.4, 5700 10/80< BSD 444, 5700<09/80 BSD 442, 5900 BSD 444, 6410 BSD 444, 655 BSD 444, 655 A BSD 444, 655 C BSD 444, 655 D BSD 444, 6600 10.80> BSD 444, 6600>09.80 BSD 444, 6610 BSD 444, 6635 L85 8045.25, 6640 P.S. 5.0, 6700 BSD 444, 6710>09.80 BSD 444, 6710>10.80 BSD 444, 6810 BSD 444TS, 7000 BSD 444T, 7410 BSD 444T, 7600 BSD 444TS, 7610 BSD 444TS, 7635 L95 8045.25, 7700 BSD 444TS, 7710 BSD 444TS, 7740 P.S. 5.0T, 7810 BSD 666, 7840 P.S. 6.6, 7910 BSD 666, 8000 BSD 666, 8100 BSD 380, 8160 M100 P.S. 7.5, 8200 BSD 666, 8210 BSD 666, 8240 P.S. 7.5, 8260 M115 P.S. 7.5, 8340 9/93< P.S. 7.5T, 8340<8/93 P.S. 7.5, 8360 M135 P.S. 7.5T, 8401 BSD 666, 8530 BSD 666, 8560 M160 P.S. 7.5TI, 8600 BSD 666, 8630 BSD 666T, 8670 G170 P.S. 7.5T, 8700 BSD 666, 8730 BSD 666T, 8770 G190 P.S. 7.5T, 8830 BSD 666TI, 8870 G210 P.S. 7.5TI, 8970 G240 P.S. 7.5TI, 9000 BSD 666T, 9200 BSD 666T, 9600 BSD 666T, 9700 BSD 666T, TW 10, TW 15, TW 20, TW 25, TW 30, TW 35, TW 5	83937061, 84535312	
02742		3230 - 3430, 3930, 3930H - 3930N - 3930NO, 4130 - 4130N - 4130NO, 4630 - 46300 - 4630N - 4630NO, 4830 - 4830N - 48300, 5030 - 50300, 5110 - 5610, 6410 - 6610 - 6710 - 6810, 66100 - 76100, 7410 - 7610 - 7710, TW10 - TW20 - TW30	1930277, 83917626, 86570171	
15400		8630-8830	1909107	
15406	4635, 4835, 5635, 6635, 7635, 8430, 8630, 8830	1930581		

Art./Ref.	Brand	Applicazione/Application	Rif. Orig./Orig. Ref.	Immagine/Image
41574	FORD	5610S, 6610S, 6810S, 7010 - 8010, 7610S	87801285	
41637		8160, 8260, 8360, 8560	87840590	
41867		8160, 8260, 8360, 8560	87840591	
02731	JOHN DEERE	1020, 1030, 1120, 1130, 1630, 2020, 2030, 3020, 3130, 4020, 820, 830, 920, 930	AT17387	
53230		1020, 1030, 1040, 1120, 1130, 1140, 1350, 1550, 1630, 1640, 1750, 1840, 1850, 1850N, 1950, 1950N, 2020, 2030, 2040, 2040s, 2140, 2250, 2450, 2550, 2650, 2650N, 2850, 3020, 3030, 3040, 3050, 3140, 3350, 3640, 3640S, 3650, 4030, 4040, 4040S, 4050 6359, 4240, 4240S, 4440, 5000, 5010, 5015, 5020, 6000, 6010, 6020, 6100, 820, 830, 840, 920, 930, 940	AR50041	
53237		3100, 3200, 3300, 3400, 6000, 6200, 6210, 6300, 6400, 6600, 6610, 6800, 6810, 6900, 6910	RE62418	
57934		SERIE 6000, SERIE 6010	RE62419	
85515		MOT COMMON RAIL SERIE 6010, MOT COMMON RAIL SERIE 6020, MOT COMMON RAIL SERIE SE6010, MOT COMMON RAIL SERIE SE6020	RE509208	
85516		MOT COMMON RAIL 4CIL SE SE6020, MOT COMMON RAIL 4CIL SERIE6015, MOT COMMON RAIL 4CIL SERIE6020	RE509031	

Art./Ref.	Brand	Applicazione/Application	Rif. Orig./Orig. Ref.	Immagine/Image
85517	JOHN DEERE	MOT COMMON RAIL 6CIL SERIE6020, MOT COMMON RAIL 6CIL SERIE7020	RE509032	
85518		MOT COMMON RAIL 6CIL SERIE6020, MOT COMMON RAIL 6CIL SERIE7020	RE509036	
85519		GOLDONI MOTORI JOHN DEERE, SERIE 5015, SERIE 5015F&V	RE60021	

**FILTRI NAFTA ORIGINALI JOHN DEERE**

FILTRE A GAZOLE ORIGINAL JOHN DEERE

FUEL FILTER ORIGINAL JOHN DEERE

KRAFTSTOFF FILTER ORIGINAL JOHN DEERE

FILTRO GASOIL ORIGINAL JOHN DEERE



Art./Ref.	Brand	Rif. Orig./Orig. Ref.
JDAR50041	JOHN DEERE	AR50041
JDAR86745		AR86745
JDRE508633		RE508633
JDRE509031		RE509031
JDRE509032		RE509032
JDRE509036		RE509036, RE517180
JDRE509208		RE509208, RE517181
JDRE522878		RE522878
JDRE526557		RE526557
JDRE529643		RE529643, RE541922
JDRE529644		RE529644, RE546336
JDRE60021		RE60021
JDRE62418		RE62418
JDRE62419		RE53400, RE62419

**FILTRI NAFTA ADATTABILI LANDINI**

FILTRE A GAZOLE ADAPTABLE LANDINI

FUEL FILTERS ADAPTABLE LANDINI

KRAFTSTOFF FILTER PASSEND ZU LANDINI

FILTRO GASOIL ADAPTABLE LANDINI

Art./Ref.	Brand	Applicazione/Application	Rif. Orig./Orig. Ref.	Immagine/Image
02042		GHIBLI, GLOBUS, POWERFARM, TIER 2	E3541384M1	
02731	LANDINI	ADVANTAGE CABINATO: 55F, ADVANTAGE CABINATO: 55GT, ADVANTAGE CABINATO: 55L, ADVANTAGE CABINATO: 60F, ADVANTAGE CABINATO: 60GT, ADVANTAGE CABINATO: 60L, ADVANTAGE CABINATO: 65F, ADVANTAGE CABINATO: 65GT, ADVANTAGE CABINATO: 65L, ADVANTAGE CABINATO: 75F, ADVANTAGE CABINATO: 75GT, ADVANTAGE CABINATO: 75L, ADVANTAGE CABINATO: 85F, ADVANTAGE CABINATO: 85GT, ADVANTAGE CABINATO: 85L, ADVANTAGE CABINATO: L95GT, ADVANTAGE F.S.: 55FP/LP/GT, ADVANTAGE F.S.: 60FP/LP/GT, ADVANTAGE F.S.: 65FP/LP/GT, ADVANTAGE F.S.: 75FP/LP/GT, ADVANTAGE F.S.: 85FP/LP/GT, ATLAS: 100, ATLAS: 70, ATLAS: 75, ATLAS: 80, ATLAS: 85, ATLAS: 90, BLIZZARD: 50, BLIZZARD: 60, BLIZZARD: 65, BLIZZARD: 75, BLIZZARD: 85, BLIZZARD: 95, CINGOLATI C:C4500, CINGOLATI C:C4830, CINGOLATI C:C5500, CINGOLATI C:C5830, CINGOLATI C:C6500, CINGOLATI C:C6830, CINGOLATI C:C7800, CINGOLATI C:C7830, CINGOLATI C:C8860, CINGOLATI: C5000, CINGOLATI: C6000, CINGOLATI: CF4830, CINGOLATI: CF5030, CINGOLATI: CF5830, CINGOLATI: CF6030, CINGOLATI: CF6060, CINGOLATI: CF6830, FRUTTETI 530 F/L/V: 4530V, FRUTTETI 530 F/L/V: 5530 F/L/V, FRUTTETI 530 F/L/V: 6030 F/L/V, FRUTTETI 530 F/L/V: 6530 F/L/V, FRUTTETI 530 F/L/V: 7530 F/L/V, FRUTTETI 560 F/L/V: 4560V, FRUTTETI 560 F/L/V: 5560 F/L/V, FRUTTETI 560 F/L/V: 6060 F/L/V, FRUTTETI 560 F/L/V: 6560 F/L/V, FRUTTETI 560 F/L/V: 7560 F/L/V, FRUTTETI 560 F/L/V: 8560 F/L/V, GHIBLI: 100, GHIBLI: 90, GLOBUS: 60, GLOBUS: 70, GLOBUS: 85, GLOBUS: 10000, LARGE: 10000S, LARGE: 12500, LARGE: 13000, LARGE: 14500, LEGEND N/G: 115, LEGEND N/G: 120, LEGEND N/G: 130, LEGEND N/G: 140, LEGEND N/G: 160, LEGEND N/G: 180, LEGEND: 105, LEGEND: 115, LEGEND: 130, LEGEND: 145, LEGEND: 165, MYTHOS: 110, PRIMI MODELLI 5000R-DT-S-N, PRIMI MODELLI 6000R-DT-S, PRIMI MODELLI 7000 SPECIAL, PRIMI MODELLI 7000R-DT, PRIMI MODELLI 8000R-DT-S, REX CABINATI: 100, REX CABINATI: 60, REX CABINATI: 70, REX CABINATI: 80, REX CABINATI: 90, REX FOOT STEP: 100FP-LP-GTP-GE, REX FOOT STEP: 60FP-LP-GE, REX FOOT STEP: 70FP-LP-GTP-GE, REX FOOT STEP: 80FP-LP-GTP-GE, REX FOOT STEP: 90FP-LP-GTP-GE, SERIE 30: 5830, SERIE 30: 6030, SERIE 30: 6830, SERIE 30: 7830, SERIE 30: 8830, SERIE 40: 5840, SERIE 40: 6040, SERIE 40: 6840, SERIE 500: 5500, SERIE 500: 6500, SERIE 500: 7500, SERIE 500: 8500, SERIE 500: 9500R-DT, SERIE 50: 6550, SERIE 50: 7550, SERIE 50: 8550, SERIE 60 NEW: 5860, SERIE 60 NEW: 6860, SERIE 60 NEW: 7860, SERIE 60 NEW: 8860, SERIE 60: 5860, SERIE 60: 6060, SERIE 60: 6860, SERIE 60: 7860-7860HC, SERIE 60: 8860-8860HC, SERIE 60: 9060, SERIE 70: 5870, SERIE 70: 6070, SERIE 70: 6870, SERIE 70: 7870, SERIE 70: 8870, SERIE 80: 6880, SERIE 80: 7880, SERIE 80: 8880-8880HC, SERIE 80: 9080-9080HC, SERIE 80: 9880-9880HC, TREKKER NEW 100C, TREKKER NEW 70 C/F/L, TREKKER NEW 80 C/F/L, TREKKER NEW 90 C/F/L, TREKKER: C75, TREKKER: C85, TREKKER: C95, TREKKER: CF55, TREKKER: CF60, TREKKER: CF65, TREKKER: CF70, TREKKER: CF75, TREKKER: CF85, VIGNETI CABINA V.Q: 55V, VIGNETI CABINA V.Q: 60V, VIGNETI CABINA V.Q: 65V, VIGNETI CABINA V.Q: 75V, VIGNETI F.S.: 55V, VIGNETI F.S.: 60V, VIGNETI F.S.: 65V, VIGNETI FOOT STEP: 75V, VIGNETI REX CAB: 60V, VIGNETI REX CAB: 65V, VIGNETI REX CAB: 70V, VIGNETI REX CAB: 80V, VISION: 100, VISION: 80, VISION: 90	E3541160M1	
02742		CINGOLATI: C10500, LARGE: 16000, LARGE: 16500	1896287M91, E3541382M1	
37104		MISTRAL:40, MISTRAL:45, MISTRAL:50	3653390M1	

**FILTRI NAFTA ORIGINALI LANDINI**

FILTRE A GAZOLE ORIGINAL LANDINI  
 FUEL FILTER ORIGINAL LANDINI  
 KRAFTSTOFF FILTER ORIGINAL LANDINI  
 FILTRO GASOIL ORIGINAL LANDINI

Art./Ref.	Brand	Rif. Orig./Orig. Ref.
LN3653390M1	LANDINI	3653390M1
LNE3541384M1		E3541384M1
LNE3541382M1		E3541382M1
LNE3541160M1		E3541160M1

**FILTRI NAFTA ADATTABILI**

FILTRE A GAZOLE ADAPTABLE  
 FUEL FILTERS ADAPTABLE  
 KRAFTSTOFF FILTER PASSEND ZU  
 FILTRO GASOIL ADAPTABLE

Art./Ref.	Brand	Applicazione/Application	Rif. Orig./Orig. Ref.	Immagine/Image
02042	LOMBARDINI	LDW 1003, LDW 1204, LDW 1404, LDW 903	2175.143	
02058		5LD 2-3 cil 3/T, 11LD, 5LD 4 cil, 8LD, 9LD, CHD 1503, CHD 2004, CHD 2004/T, DVA 1030, DVA 1030/S, DVA 1200, LDW 1204, LDW 1404	2175.046	
02731		673, 825, LDA 670, SLD675	2175.042	
08251		5LD 625-3 TURBO, 5LD 675-2, 5LD 675-3, 5LD 675-4, 5LD 825-2, 5LD 825-2L, 5LD 825-3, 5LD 825-3L, 5LD 825-4, 5LD 825-4L, 5LD 930-3, 5LD 930-4, LDA 672, LDA 673, LDA 674, LDA 832, LDA 833, LDA 834	2175.014	
26518		400 - 6LD400C - 400V, 6LD260 - 260C, 6LD325 - 325C, 6LD360 - 360C, 6LD360V, 6LD435, LDA500 - 503 - 520 - 522 - 530	2175.045	



Art./Ref.	Brand	Applicazione/Application	Rif. Orig./Orig. Ref.	Immagine/Image
02042		3075 1004.4, 3075 A4.236, 3085 1006.6, 3095 1006.6, 3115 1006.6, 3120 1006.6T, 3120T 1006.6T, 3125 1006.6T, 3140 1006.6T, 3635 1006.6T, 3645 1006.6T, 3655 1006.6T, 3660 1006.6T, 4225 1004.4, 4225 4.41, 4235 1004.4, 4235 4.41, 4245 1004.4T, 4255 1004.4T, 4255 4.41, 4260 1006.6, 4270 1006.6, 6110 4.41, 6120 4.41, 6130 1004.4T, 6140 1004.4T, 6150 1004.4T, 6160 1006.6, 6160 1006.6T, 6170 1006.6, 6170 1006.6T, 6180 1006.6T, 6190 1006.6T, 8110 1006.6T, 8120 1006.6T <F, 8130 1006.6T	2862362M1, 3638281M1, 3638291M1, 3638510M1	
02731	MASSEY FERGUSON	1080 A4.318, 1100 A6.354.1, 1105 A6.354.4, 1135 A6.354.4, 1200 A6.354.1, 1250 A6.354.4, 135 AD3.152, 148 AD3.152, 155 AD4.203, 158 AD4.203, 165 A4.212, 165 AD4.203, 168 A4.236, 175 A4.236, 178 A4.248, 185 A4.248, 230 AD3.152, 235 AD3.152, 240 AD3.152, 250 AD3.152, 255 AD3.152, 260 AD4.203, 2620 A6.354.4, 2625 A6.354.4, 2640 A6.354.4, 2645 A6.354.4, 265 A4.236, 2680 AT6.354.4, 2685 AT6.354.4, 2720 AT6.354.4, 2725 AT6.354.4, 275 A4.236, 285 A4.248, 285 A4.318, 290 A4.248, 294 A4.248, 296, 298 A4.318, 3050 A4.236, 3060 A4.248, 3065 A4.236, 3070 A4.236, 3075 1004.4, 3075 A4.236, 3080 A6.354.4, 3085 1006.6, 3090 A6.354.4, 3095 1006.6, 3115 1006.6, 3120 1006.6T, 3120T 1006.6T, 3125 1006.6T, 3140 1006.6T, 340 AD3.152, 342 AD3.152, 35 A3.152, 350 AD3.152, 352 AT3.152, 355 AT3.152, 360 AT3.152, 3610 A6.354.4, 362 A4.236, 3630 AT6.534.4, 3635 1006.6T, 3645 1006.6T, 3645 AT6.354.4, 365 A4.236, 3650 AT6.354.4, 3655 1006.6T, 3660 1006.6T, 372 A4.236, 375 A4.236, 382 A4.248, 390 A4.248, 390T A4.236, 398 A4.236, 399 1006.6, 399 A6.354.4, 4225 1004.4, 4225 4.41, 4235 1004.4, 4235 4.41, 4245 1004.4T, 4255 1004.4T, 4255 4.41, 4260 1006.6, 4270 1006.6, 550 AD3.152, 560 AD4.203, 565 A4.236, 575 A4.236, 590 A4.248, 595 A4.318, 6110 4.41, 6120 4.41, 6130 1004.4T, 6140 1004.4T, 6150 1004.4T, 6160 1006.6, 6160 1006.6T, 6170 1006.6, 6170 1006.6T, 6180 1006.6T, 6190 1006.6T, 65 A4.203, 65 AD4.203, 675 A4.236, 690 A4.248, 698 A4.318, 698T A4.236, 699 A6.354.4, 765 AD4.203, 8110 1006.6T, 8120 1006.6T <F, 8120 1006.6T F0, 8130 1006.6T	1049939M91, 151890M1, 1640997M91, 1802271M1, 1841890M1, 1951890M1, 2871492M1, 3405418M1, 835994M92, 836218M91, 851890M1	
02742		1080 A4.318, 1100 A6.354.1, 1105 A6.354.4, 1135 A6.354.4, 1200 A6.354.1, 1250 A6.354.4, 135 AD3.152, 148 AD3.152, 155 AD4.203, 158 AD4.203, 165 A4.212, 165 AD4.203, 168 A4.236, 175 A4.236, 178 A4.248, 185 A4.248, 230 AD3.152, 235 AD3.152, 240 AD3.152, 250 AD3.152, 255 AD3.152, 260 AD4.203, 2620 A6.354.4, 2625 A6.354.4, 2640 A6.354.4, 2645 A6.354.4, 265 A4.236, 2680 AT6.354.4, 2685 AT6.354.4, 2720 AT6.354.4, 2725 AT6.354.4, 275 A4.236, 285 A4.248, 285 A4.318, 290 A4.248, 294 A4.248, 298 A4.318, 3050 A4.236, 3060 A4.248, 3065 A4.236, 3070 A4.236, 3080 A6.354.4, 3090 A6.354.4, 340 AD3.152, 342 AD3.152, 350 AD3.152, 352 AT3.152, 355 AT3.152, 360 AT3.152, 3610 A6.354.4, 362 A4.236, 3630 AT6.534.4, 3645 AT6.354.4, 365 A4.236, 3650 AT6.354.4, 372 A4.236, 375 A4.236, 382 A4.248, 390 A4.248, 390T A4.236, 398 A4.236, 550 AD3.152, 560 AD4.203, 565 A4.236, 575 A4.236, 590 A4.248, 595 A4.318, 675 A4.236, 690 A4.248, 698 A4.318, 698T A4.236, 699 A6.354.4, 765 AD4.203, 796, 8120 1006.6T F0	1896287M1, 3405419M1	
11267		35 A3.152, 65 A4.203, 65 AD4.203, FE35 4cil 23C, TEF20 4cil 20C	1850450M2, 894974M91	
02042	NEW HOLLAND	1600-1620S BRAUD VENDEMMIATRICI, B115 TERNA GOMMATA, C190 PALE CARICATRICI, L190 MINI PALE, L411-L413-L416-L516 MIETITREB, L518-L520-3300AL-3560AL MIETIT, L60, L65, L75, L85, L95, LB110.B TERBA GOMMATA, LB115.B TERBA GOMMATA, LB75 TERNA GOMMATA, LB75CP TERNA GOMMATA, LB90.B TERNA GOMMATA, LB95.B TERNA GOMMATA, LM410, LM420, LM425, LM430, LM630, LM640, SB35 BRAUD VENDEMMIATRICI, SB36 BRAUD VENDEMMIATRICI, SB52 BRAUD VENDEMMIATRICI, SB54 BRAUD VENDEMMIATRICI, SB55 BRAUD VENDEMMIATRICI, SB56 BRAUD VENDEMMIATRICI, SB58 BRAUD VENDEMMIATRICI, SB60 BRAUD VENDEMMIATRICI, SB62 BRAUD VENDEMMIATRICI, SB64 BRAUD VENDEMMIATRICI, TC52-TC54-TC55-TC56-TC57 MIET, TD55D, TD60, TD65D, TD70, TD75D, TD80, TD80D, TD80D, TD85D, TD90, TD95, TD95D, TK100A CINGOLATO, TK65F CINGOLATO, TK65V CINGOLATO, TK70FA CINGOLATO, TK70VA CINGOLATO, TK75F CINGOLATO, TK75FA CINGOLATO, TK75M CINGOLATO, TK75MA CINGOLATO, TK75V CINGOLATO, TK75VA CINGOLATO, TK76 CINGOLATO, TK76M CINGOLATO, TK80A CINGOLATO, TK80MA CINGOLATO, TK85 CINGOLATO, TK85M CINGOLATO, TK90A CINGOLATO, TK90MA CINGOLATO, TK95M CINGOLATO, TL100, TL55F, TL60, TL60E, TL65, TL65A, TL65F, TL70, TL75, TL75E, TL75F, TL80, TL85, TL85E, TL90, TL95, TL95E, TN55, TN55D, TN55S, TN55V, TN60A, TN60DA, TN60SA, TN60VA, TN65, TN65D, TN65F, TN65N, TN65S, TN65V, TN70, TN70A, TN70D, TN70DA, TN70F, TN70NA, TN70S, TN70SA, TN70VA, TN75, TN75A, TN75D, TN75DA, TN75F, TN75FA, TN75N, TN75NA, TN75S, TN75SA, TN75V, TN75VA, TN80F, TN85FA, TN90F, TN95F, TN95FA, TN95NA, TN95VA, TT50, TT55, TT65, TT75, VL6040 VENDEMMIATRICI, VL6050 VENDEMMIATRICI, VL6060 VENDEMMIATRICI, VL6070 VENDEMMIATRICI, VL6080 VENDEMMIATRICI, VL6090 VENDEMMIATRICI, VM4090 VENDEMMIATRICI	1930010, 47135706, 84214564	

Art./Ref.	Brand	Applicazione/Application	Rif. Orig./Orig. Ref.	Immagine/Image
02043	NEW HOLLAND	MIETITREBBIE SERIE L - TX, TK 160-55 CINGOLATO	84230126	
02058		1530-1550, M103, M133/1, M135/1, M140	8123679	
02731		L454 MINI PALE, L455 MINI PALE, L553 MINI PALE, L555 MINI PALE, L778 MINI PALE, L779 MINI PALE, L781 MINI PALE, L783 MINI PALE, L785 MINI PALE, L865 MINI PALE, LX865, LX885, SB33 BRAUD VENDEMMIATRICI, SB52 BRAUD VENDEMMIATRICI, SB53 BRAUD VENDEMMIATRICI, SB54 BRAUD VENDEMMIATRICI, SB56 BRAUD VENDEMMIATRICI, SB58 BRAUD VENDEMMIATRICI, TS 100, TS 110, TS 115, TS 80, TS 90	1909100, 84535312	
08251		8070-8080	1909113	
15400		MIETITREBBIE SERIE L - TX, TK160-55 CINGOLATO, TRINCIA 9630-9640-9645, TRINCIA SERIE FX	84406504	
15406		L60, L65, L75, L85, L95, TD5.100, TD5.110, TD5.65, TD5.75, TD5.80, TD5.90, TD55D, TD60, TD60D, TD65D, TD70, TD70D, TD75D, TD80, TD80D, TD85D, TD90, TD90D, TD95, TD95D, TK100A, TK76 CINGOLATO, TK76M CINGOLATO, TK80A CINGOLATO, TK80MA CINGOLATO, TK85 CINGOLATO, TK85M CINGOLATO, TK90A CINGOLATO, TK90MA CINGOLATO, TK95M CINGOLATO, TL100, TL55F, TL60, TL60E, TL65, TL65A, TL65F, TL70, TL75, TL75E, TL75F, TL80, TL85, TL85E, TL90, TL95, TL95E, TT50, TT55, TT65, TT65D, TT75	84217953	
41574		555E - 575E - 655E TERNA GOMM, 75TLB - 85TLB - 95TLB TERNA GO, SERIE LB - LB.B TERNA GOMMATA, TC54 - TC56 MIETITREBBIA, TS100, TS110, TS115, TS120, TS80, TS90	87801285	
41637		M100, M115, M135, M160, TM110, TM115, TM120, TM125, TM130, TM135, TM140, TM150, TM155, TM165, TM175, TM180, TM190, TV140	87840590	
41867		M100, M115, M135, M160, TM110, TM120, TM130, TM140	87840591	

**FILTRI NAFTA ORIGINALI CNH**

FILTRE A GAZOLE ORIGINAL CNH  
 FUEL FILTER ORIGINAL CNH  
 KRAFTSTOFF FILTER ORIGINAL CNH  
 FILTRO GASOIL ORIGINAL CNH

Art./Ref.	Brand	Rif. Orig./Orig. Ref.
NH1909103	NEW HOLLAND	1909103, 84230126
NH1909107		1909107, 84406504
NH1909109		1909109
NH1909113		1909113
NH1930277		1930277, 47377748
NH1930581		1930581, 84217953
NH47135706		47135706, 84214564
NH84535312		1909100, 84535312
NH84171722		84171722, 84565884
NH87487344		47367180, 84477495
NH87802332		84559020, 87802332
NH87840590		84559023, 87840590
NH87840591		84477351, 87840591
NH5181823		5181823
NH9611973		9611973



**FILTRI NAFTA ADATTABILI PERKINS**

FILTRE A GAZOLE ADAPTABLE PERKINS  
 FUEL FILTERS ADAPTABLE PERKINS  
 KRAFTSTOFF FILTER PASSEND ZU PERKINS  
 FILTRO GASOIL ADAPTABLE PERKINS

Art./Ref.	Brand	Applicazione/Application	Rif. Orig./Orig. Ref.	Immagine/Image
02042	PERKINS	1006.60, 500 TURBO ED ASPIRATO	26561118	
02731		1004.40, 1004.40T, 1004.42, 3.152.2, 3.152.4, 4.108, 4.236, 403D-11, 403D-15, 404D-22, 6.354.4, D3.152, T4.236, T6.354.4	26560017, 26561117	
02742		6.354 - T6.354, 6.354.4 - T6.354.4, V8.540 - TV8.540	26560602, 26566602	
70564		1103A-33, 1103A-33T, 1103C-33, 1103C-33T, 1103C-33TA	26560163	
70565		1104A-44, 1104A-44T, 1104A-44TA, 1104C-44, 1104C-44T, 1104C-44TA, 1104CE-44TA, 1104D-44, 1104D-44T, 1104D-44TA	26560201	

**FILTRI NAFTA ORIGINALI PERKINS**

FILTRE A GAZOLE ORIGINAL PERKINS  
 FUEL FILTER ORIGINAL PERKINS  
 KRAFTSTOFF FILTER ORIGINAL PERKINS  
 FILTRO GASOIL ORIGINAL PERKINS

Art./Ref.	Brand	Rif. Orig./Orig. Ref.
<b>PK26560201</b>	<b>PERKINS</b>	26560201
<b>PK26561117</b>		26561117
<b>PK26561118</b>		26560608, 26561118
<b>PK26566602</b>		26566602
<b>PK26560137</b>		26560137

**FILTRI NAFTA ADATTABILI**

FILTRE A GAZOLE ADAPTABLE  
 FUEL FILTERS ADAPTABLE  
 KRAFTSTOFF FILTER PASSEND ZU  
 FILTRO GASOIL ADAPTABLE

Art./Ref.	Brand	Applicazione/Application	Rif. Orig./Orig. Ref.	Immagine/Image
<b>02058</b>		155-54TA/TE/TX/TZ, 160-94TZ, 180-94TZ, 175-74TZ, 321-4, 451-4, 571-4, 481-4, 581-4, 50-12LB/V, 55-12LB/V, 70-12V/F, R1451-4	6005000383, 6005000788, 7701017732	
<b>02731</b>	<b>RENAULT</b>	103.12RS/TS/TX, 103.14RS/TX, 103.54TM/TX, 106-14SP, 110-14RE/TA/TE/TS/TX, 106.14RS/TX, 106.54TL, 110.54T, 106.54 MWM, 110-54TA/TE/TS/TX/TZ, 120-54TA, 113.14TX, 133.14TS/TX, 145.14T, 1151 1151-4, 1181 1181-4, 1451-4 (R7694), 155.54TZ, 155.54TX/TZ/Nectra,, 301, 351M, 32-5032-60, 321-4, 451-4, 571-4, 42-70F/V, 44-70F/V, 421 M, 421M, 456 M, 460 M, 461, 461M/Spezial, 462 M, 466S, 480S/V, 486 M, 489 M, 490 (R7398-4-L), 496 M, 498 M, 50 (7211) MWN 325-2, 50 S/SV MWN D327-2, 50.12LB, 55.12LB, 58.32MX, 58., 501-4, 601-4, 51 (7254) 56 (7251), 53 (7213) MWN 325-2, 55 (7231) 57 (7241), 551 551-4, 551-43, 556 556S, 58-12LS, 58-14LS, 61-12RA/RS,, 58-32MA/ME/MS/MX, 58-34MA/ME/M, 60 (7253) 61 (7254), 600M, 600MI, 60S MWN 325-3, 61.12RS, 61.14S/RS MWN 325-3, 65.12LS, 65.32MX, 65.34MX D22, 651, 651-4, 652, 656, 656S, 68, 68-12RA/RS, 68-14RA/RS, 75-12L, 68.12RS, 68.14RS, 70 MWM D305-3R, 70 (7252) MWM, 70-12SP, 70-14SP, 70-32PA/PE/PS/PX, 70-34PA/PE/P, 70.12LB, 70.14LB, 70.34PX/Trac, 700M/H, 720M/H, 704M/H, 724M/H, 701-4, 701-4F, 75-32MA/ME/MS/MX/TX, 75-34ME/M, 750MI, 745MI, 800M, 804M, 850M, 751, 751S, 751-4, 752, 781, 78, 80 MWM D305-3R, 80 MWM D325-3R, 80 (7282) 86 (7281), 80-12, 80-14, 85.34MX, 85.34TX, 80-12SP, 80-14SP, 80-12TX, 80-14TX, 80-32PA/PE/PS/PX, 80-34PA/PE/P, 80S/V MWM D327, 85-12LS/TS/TX, 85-14LS/TS/TX, 85-32MA/ME/MS/MX/TX, 85-34MA/M, 85.12LS 85.14LS, 851, 851-4, 851-4S, 86, 88 598-, 89 MWM D226-3, 891, 891-4, 90.34MX/Tracfor, 90.34TX91TP91, 900MIH, 904MIH, 90S/V/Conf., 92, 921 921-4, 95-12RE/RS/TS/TX, 95-14RE/RS/T, 95.12TX 95.14TX, 981 981-4, Ceres65, Ceres70, Ceres70X, Ce, Ceres85, Ceres85X, Ceres95, Ce, Master 1, Master 1 TP, Master, MWM D325-4R, 226-4, 325-4, D22, R301, R351M, R32-50EV-SV-V, R32-60F-V(A/B), R361, R421-421M, R461, R461M,, R42-70V, R44-70F, R90S Verger,, R50, R51, R56, R60, R70, R80,, R50S, R53, R55, R551, R551S, R551-4, R551-4S,, R651, R651S, R651-4, R651-4S,, R751, R751S, R751-4, R751-4S,, R782, R782-4, R851, R851-4, R8, R89, R92, R489, R891, R891S, R891-4S, R951, R9, R91, R94, R96, R98, R496, R498, Super 5D, Super 7, Super 7D	6005000894, 6005007409	
<b>02742</b>		110-54TA/TE/TS/TX/TZ, 120-54TA, 133-12TS/TX, 133-14RE/TA/TS/TX, 58-12LS, 58-14LS, 61-12RA/RS,, 58-32MA/ME/MS/MX, 58-34MA/ME/M, 650MI	6005000895, 6005007410	
<b>08251</b>		Super 6, Super 6D	0854806000	

Art./Ref.	Brand	Applicazione/Application	Rif. Orig./Orig. Ref.	Immagine/Image
02058	RUGGERINI	11 LD 625, L27, L40, L54, LDA672, LDA673, LDA674, LDA832	175.19	
02731		833	-	
02042	SAME	ARGON 50, ARGON 60, ARGON 70, DORADO 60, DORADO 65, DORADO 70, GOLDEN 60, GOLDEN 65, GOLDEN 75, GOLDEN 85, RUBIN 120, RUBIN 135, RUBIN 150, SILVER 100.4, SILVER 100.6, SILVER 110, SILVER 130, SILVER 80, SILVER 90	0.009.4687.0	
02731		ANTARES 100, ASTER 60, ASTER 70, AURORA 45, BUFFALO 120, CENTAURO 70 EXPLORER, CENTAURO 70 SPECIAL, CENTURION 75, CENTURION 75 EXPLORER, CENTURION 75 SPECIAL, CONDOR 55, CONDOR C, CORSARO 70 FRUTTETO, CORSARO 70 SYNCRO, DELFINO 35, DELFINO 35 FRUTTETO, DRAGO 100, EXPLORER 70 C, EXPLORER 55, EXPLORER 60, EXPLORER 60 SPECIAL, EXPLORER 65, EXPLORER 65 C, EXPLORER 65 SPECIAL, EXPLORER 70, EXPLORER 70 SPECIAL, EXPLORER 75, EXPLORER 75 C, EXPLORER 75 SPECIAL, EXPLORER 80, EXPLORER 80 C, EXPLORER 90 C, EXPLORER 90 II SPECIAL, EXPLORER 90 SPECIAL, EXPLORER II 60, EXPLORER II 60 SPECIAL, EXPLORER II 70, EXPLORER II 70 SPECIAL, EXPLORER II 70 SPECIAL B, FRUTTETO 60, FRUTTETO 60 II, FRUTTETO 75, FRUTTETO 75 II, FRUTTETO 85 II, LEOPARD 85, LEOPARD 85 EXPLORER, LEOPARD C, MERCURY 85 EXPLORER, MERCURY 85 SPECIAL, MINITAURO 60, MINITAURO 60 FRUTTETO, MINITAURO C, MINITAURUS 60 FRUTTETO, MINITAURUS 60 SYNCRO, PANTHER 95, RANGER 45, RANGER 45 FRUTTETO, ROW CROP 80, ROW CROP 85, ROW CROP 90, SAME ROCK 55, SAME ROCK 60, SAME ROCK 70, SATURNO 80, SATURNO 80 SYNCRO, SOLAR 50, SOLAR 55 C, SOLAR 60, SOLAR 60 C	2.4319.060.1	
02742		ANTARES 110 - 110 II, ANTARES 130 - 130 II, BUFFALO 3000, DRAGO 100 - 120, GALAXI 170, JAGUAR 95 - 100 EXPORT, LASER 100, LASER 110, LASER 125, LASER 130, LASER 150, LASER 90, LEOPARD 90 TURBO, PANTHER 90 - 95, SUPERTITAN, TIGER 100, TIGER SIX 105 EXPORT, TITAN 145, TITAN 150, TITAN 160, TITAN 165, TITAN 190, TRIDENT 130 EXPORT	2.4319.130.1	
02058	SAME LAMBORGHINI HURLIMANN	D100, D115, D115T, D150, D180, D210, D310, D310T, D500, D95, DIAMOND, R704 - R704DT, R804 - R804DT, R904 - R904DT, T5200, T6200, T6700	2.4319.500.1	
08251		1R-1C-2R-4R-5C LAMBORGHINI, 452 LAMBORGHINI, 4C-7R-7RDT LAMBORGHINI, CENTAURO 60-65 SAME, LEONE 70-75 SAME, MINITAURO 55 SAME, R226-C226 LAMBORGHINI, R230-C230-C230S LAMBORGHINI, R340-C340-C350 LAMBORGHINI, R360-R365-R470 LAMBORGHINI, R475-R480-R485 LAMBORGHINI	0.003.1413.0, 2.4319.530.4	
26518		C503S-R503S-R503DT LAMBORGHINI, R240 LAMBORGHINI, R350 LAMBORGHINI, R603-R603DT LAMBORGHINI	2.4319.510.1	

**FILTRI NAFTA ORIGINALI SAME DEUTZ FAHR**

FILTRE A GAZOLE ORIGINAL SAME DEUTZ FAHR  
 FUEL FILTER ORIGINAL SAME DEUTZ FAHR  
 KRAFTSTOFF FILTER ORIGINAL SAME DEUTZ FAHR  
 FILTRO GASOIL ORIGINAL SAME DEUTZ FAHR

Art./Ref.	Brand	Rif. Orig./Orig. Ref.
<b>V0.009.4687.0</b>	<b>SAME</b>	0.009.4687.0
<b>V01180597</b>	<b>SAME</b>	01180597
<b>V2.4319.060.1</b>	<b>SAME</b>	2.4319.060.1
<b>V2.4319.130.1</b>	<b>SAME</b>	2.4319.130.1

**FILTRI NAFTA ADATTABILI**

FILTRE A GAZOLE ADAPTABLE  
 FUEL FILTERS ADAPTABLE  
 KRAFTSTOFF FILTER PASSEND ZU  
 FILTRO GASOIL ADAPTABLE

Art./Ref.	Brand	Applicazione/Application	Rif. Orig./Orig. Ref.	Immagine/Image
<b>02042</b>		9084 WD401, M975 WD301, 1108 WD61,44, 1200 WD612,40, 1300 WD61,44, 1350 WD61,44, 540, 545, 548, 650, 7070, 760, 768, 8055A, 8055S, 8060, 8065 Turbo, 8070A, 8075, 8080 Turbo, 8090, 8100, 8110, 8120, 8130, 8130 Turbo, 8140, 8150, 8160 WD612.85, 612.89, 8160A WD612.85, 612, 8170 Turbo, 8170A WD612.85, 612, 870, 9078A WD401, 9083A WD401, 9086 WD401, 9086A WD401, 9094A WD401, 9105A, 9115A, 9125A, 9145A, 942 WD308.48, 308., 946A WD301, 948 WD308.48, 308., 955A WD301, 970A WD301, 980, 988, M968A WD301, Plus 30, 430 WD210, Plus 80, 90 1	407080074, 407080116	
<b>02742</b>	<b>STEYR</b>	M9078A, Valmet 420.81, 420., M9086 Valmet 420.81, 420.82., M9094 Valmet 420.81, 420.	P945X	
<b>08251</b>		180 2A, 180A, 182A, 185, 188, 190, 190S, 192, 288, 290, 292, 8160 Turbo WD612.85, 8170 Turbo, 8180 Turbo WD612.89, 8300, 84E, 88, 92, Plus 40 WD307/W410, Plus 50 WD307/W410, Plus 70 WD307/W410, Plus 80, 90 1 A Serie	407 08 01 32	

**TABELLA COMPARAZIONI FILTRI NAFTA PER CODICE AMA - ARTICOLI ADATTABILI ALLE SEGUENTI MARCHE**

TABLEAU COMPARAISONS DIESEL FILTRES POUR CODE AMA  
 TABLE OF DIESEL FILTER COMPARISONS PER AMA CODE  
 KRAFTSTOFF FILTER VERGLEICHSTABELLE NACH AMA-CODE  
 TABLA COMPARACIONES FILTROS GASOIL PARA CODIGO AMA

Riferimento AMA	OEM	Riferimento FIAAM	Riferimento Tecnocar	Riferimento M+H	Riferimento Donaldson	Riferimento UFI	Note
02042	1930010	FP4935A	RN58B	WK842/1	P55-0588	24.355.00	ALLIS (1903628, applicaz.8065LE00), CAV (7176-496A), FLEETGUARD (FF5135)
02043	1909103	FT4713	RN170	WK1168	P55-1605	24.308.00	-
02058	2175.046	FP4683	RN45	WK731	P55-0440, P55-0943, P55-3004, P77-9451	24.307.00	CAV (7176-494), GOLDONI
02731	1909100	FP4378	N1117	P917x	P55-6245	24.360.00	CAV (7111-296), KUBOTA (15451-43560), LINDNER (P917X)
02742	1930277	FP4779	N1118	P945x	P55-6287	24.361.00	CAV (7111-796)
08251	1909108	FA4487	N1147	P707	-	26.609.00	BOSCH (1.457.431.261)
11267	1850450M2	FA4167	N11816	P824X	-	26.602.00	BALDWIN (PF8205)
15400	1909107	FD1513	N1134	P982X	P55-0347	21.059.00	-
15401	1909109	FA4156	N11950	P947	P77-9318	26.605.00	-
15402	1909112	FA4154	N1124	P825T	P77-9257	26.606.00	-
15406	1930581	FT5331	RN120	WK9029	-	-	-
26518	2.4319.510.1	FP4712	RN297	WK712/2	P55-0345	24.357.00	FRAM (P4506)
37104	3653390M1	-	-	-	P50-2161	26.681.00	BALDWIN (PF717)
41574	87801285	FT5550	RN144	WK8123	P55-1433	24.432.00	-
41637	87840590	-	-	WK8114	P55-0435	-	BALDWIN (BF7677D)
41867	87840591	-	-	-	P55-1430	-	BALDWIN (BF7679D)
53230	AR50041	FT4903	-	WK13001	P55-1130	-	-
53237	RE62418	-	-	-	P55-1423	-	BALDWIN (BF7675D), FLEETGUARD (FS19831)
57934	RE62419	-	-	-	P55-0397	-	BALDWIN (BF7674)
70564	26560163	-	-	-	-	-	BALDWIN (BF7925), FIL FILTER (MFE1490)
70565	26560201	-	-	-	-	-	BALDWIN (PF7902), FIL FILTER (MFE1489)
85515	RE509208	-	-	-	-	-	-
85516	RE509031	-	-	-	-	-	-
85517	RE509032	-	-	-	-	-	-
85518	RE509036	-	-	-	-	-	-
85519	RE60021	-	-	-	-	-	-

# 1.7.2 Filtri Olio Oil Filters



## Ricambi & accessori per macchine agricole SPARE PARTS & ACCESSORIES FOR AGRICULTURAL MACHINE

Tutti gli articoli della presente sezione, prodotti da AMA SPA e/o da terzi per conto di AMA, sono adattabili ("non originali") alle marche indicate ai sensi di quanto previsto dal REG. CE n. 1400/2002. I diritti sui marchi citati appartengono ai legittimi proprietari ed il loro uso ha l'esclusiva finalità di consentire all'utilizzatore la comparazione dei diversi prodotti. All items of this section, manufactured by AMA SPA and/or any third party on behalf of AMA, are adaptable ("non-original") to the brands listed under the provisions of the REG. CE n. 1400/2002. The rights on the trademarks belong to their respective owners and their usage is only aimed to allow the user to compare different products.



**FILTRI OLIO ADATTABILI CASE**

FILTRE A HUILE ADAPTABLE CASE

OIL FILTER ADAPTABLE CASE

OELFILTER PASSEND ZU CASE

FILTRO ACEITE ADAPTABLE CASE

Art./Ref.	Brand	Applicazione/Application	Rif. Orig./Orig. Ref.	Immagine/Image
27459	CASE		1329020C2	
53208		238-248-258-268-278, 2400 - 2500, 3210-3220-3230, 3210A-3220A-3230A-4210A-4220, 385-395, 454-474-574-674, 484-584-684-784, DAL 485XL AL 785XL	3136046R93	
08250	CLAAS	DOMINATOR 100-105, DOMINATOR 38-38S-48-48S, DOMINATOR 56-58S, DOMINATOR 68-68R-68S, DOMINATOR 88S-88SL-96	147.223.0, 147.225.0	
11259		COMMANDOR 112 CS, DOMINATOR 100-105, DOMINATOR 106-108S-112CS, DOMINATOR 58S SPECIAL, DOMINATOR 66, DOMINATOR 68-68R-68S, DOMINATOR 76-76H-78-78S, DOMINATOR 80-80H-85-85H, DOMINATOR 86-88S	147.222.0	
26781		DOMINATOR 80-80H, DOMINATOR 85-85H	660.576.0	
40428		DOMINATOR 100 - 105, DOMINATOR 80 - 80H - 85 - 85H, MERCATOR 60 - 65 - 70	146.790.0	
51834	DEUTZ	Agrostar DX4.61, DX4.71, Agroxtra 4.17, Agroxtra 4.47, Agroxtra 6.07, Agroxtra F6L912, Agroxtra 4.07, Agroxtra 6.17, Agroxtra BF4L913, Agroxtra F6L13, C-Serie von D4507 bis D7207, D4006 bis, D7206, D4007 bis, D7207, D7807, D7807C, DX3.10 bis, DX3.90, DX4.10 bis, DX4.70, DX50, DX80, DX86, DX92, Intrac 2002, Intrac 2003	01173481	
51838		Agroplus 100, Agrostar DX6.11, Agrottron 150, Agrottron 6.20, Agrottron 6.30, Agrottron 6.45, Agroxtra 4.17, Agroxtra 4.47, Agroxtra 6.07, Agroxtra F6L912, Agroxtra 4.07, Agroxtra 6.07, Agroxtra 6.17, Agroxtra BF4L913, Agroxtra F6L13, D10006, D13006, D8006, D9006, DX110, DX120, DX230, DX6.10, DX6.30, DX85, DX90, Intrac 2005, Intrac 2006, Intrac 6.30 Turbo	01174421, 01183574	
53202		Agrostar DX6.61, DX140, DX145, DX160, DX250, DX6.50, DX7.10, DX8.30	01174420	

Art./Ref.	Brand	Applicazione/Application	Rif. Orig./Orig. Ref.	Immagine/Image
08250	FENDT	1, 105LSA, 106LSA, 106S, 108LSA, 108S, 10S, 11S, 2, 255GT, 3, 307, 308, 308LSA 178/01, 308LSA FWA 178/26, 309, 309LSA, 310, 310LSA, 311, 311LSA, 312, 312LSA, 3S FWA238/7, 4, 4S, 4S FWA 258/7, 510C, 5S FW 268, 600LSA, 610LSA, 611LSA, 811SL	F238202310010	
26781		FARMER 1D, FIX 2E	F120203310170	
51834		200S, 201S, 203V, 204P, 205P, 240S, 250SA, 250VA, 275GT, 275VA, 280PA, 345GT, 360GT, 360GTH, 365GTA, 380GHA, 380GT, 380GTA	F100001173481, F27520301020	

02039	FIAT	120C, 355C, 455C, 465C, 465C/V/F, 505c, 555c, 565c, 605c, 655C, 765C, 805C, 80C, 855C, 90C, SERIE 55 85.55C, SERIE 65 80.65C, SERIE 65 55.65C, SERIE 65 60.65C, SERIE 65 70.65C, SERIE 66 55.66/VF, SERIE 66 56.66S, SERIE 66 60.66/LP, SERIE 66 65.66, SERIE 66 80.66, SERIE 66 80.66/F, SERIE 66 55.66, SERIE 66 60.66, SERIE 66 70.66, SERIE 66 70.66/LP-F, SERIE 66 45.66, SERIE 66 55.66/LP, SERIE 66 50.66, SERIE 75 55.75C, SERIE 75 60.75C, SERIE 75 70.75C, SERIE 75 80.75C, SERIE 76 45.76/V, SERIE 76 60.76/F, SERIE 76 70.76/LP-VF, SERIE 76 80.76/F, SERIE 85 55.85C, SERIE 85 60.85C, SERIE 85 72.85C, SERIE 85 82.85C, SERIE 85 62.85C, SERIE 86 70.86/V, SERIE 86 72.86/LP-F, SERIE 86 82.86/LP-F, SERIE 86 50.86/V, SERIE 86 55.86/VF, SERIE 86 60.86/VF, SERIE 86 62.86/F, SERIE 88 55.88, SERIE 88 60.88, SERIE 88 70.88, SERIE 88 80.88, SERIE 90 70.90, SERIE 90 55.90, SERIE 90 60.90, SERIE 90 65.90, SERIE 90 80.90, SERIE 93 65.93, SERIE 93 72.93, SERIE 93 60.93, SERIE 93 82.93, SERIE 94 72.94, SERIE 94 82.94, SERIE 94 60.94, SERIE 94 65.94	1901603, 1909101, 4597232, 4600875, 4625547, 4629544, 4630786, 4648371	
02041		100-90, 100-90 DT, 110-90, 110-90 DT, 115-90, 115-90 DT, 55-86F, 55-86F DT, 55-86S V, 55-86S V DT, 55-86V, 55-86V DT, 85-90, 85-90DT, 88-93, 88-93 DT, 88-94, 88-94DT, 90-90, 90-90DT, F100, F100 DT, F110, F110 DT, F115, F115 DT, F120, F120 DT	1901602, 1909102, 4602186, 4607360, 4625546, 4630787	
08250		80.66 - 80.66DT, 80.76 - 80.76DT	1930328, 83918040, 83963907, 87800083	
10499		130-90, 130-90 DT, 140-90, 140-90 DT, 160-90 DT, 180-90 DT, F130, F130 DT, F140, F140 DT	1930213, 1931047	
15141		311 - 311C, 312 - 312C, 315, 352C	1909110, 883834	
15403		50C OM, 60CA, OM 512 - OM 513, SERIE 60C - 60CI - 60CT, SERIE 70CI - 70R, SERIE 80CA - 80R	1901599, 1909123, 4585298, 4597635, 556404, 556494	

Art./Ref.	Brand	Applicazione/Application	Rif. Orig./Orig. Ref.	Immagine/Image
15405	FIAT	140-90 DT, 160-90, 160-90 DT, 180-90, 180-90 DT	1909137, 1930544, 79026104, 80437070, 80437072	
27459		G170, G190, G210, G240	81879134	
37997		35.66 35.66DT	1930892	
29411				
15397		-	1909104, 4060883	-
27455		-	5178100	-
35098		-	80457412	-
28243		-	1930909	-

02039	FORD	3010S, 3435, 3830, 3935, 4010S, 4030, 4135, 4230, 4430, 5010S	1909101	
02041		3010S, 3830, 4635, 4835, 5635, 6635, 7635	1909102	
08250		2000, 5000, 5500, 5610 - 5710, 6610 - 6610 SERIES II, 6710 - 6710 SERIES II, 7000 BSD 444T, 7600 BSD 444TS, 7610 BSD 444TS, 7700 BSD 444TS, 7710 BSD 444TS, 8210	A710X6714CA	
10499		8430-8630-8830	1931047	
11259		7810-78100-7910, 8210, 8530, 8630, 8730, 8830, TW5 - TW15 - TW25 - TW35	86546615	

Art./Ref.	Brand	Applicazione/Application	Rif. Orig./Orig. Ref.	Immagine/Image
15405	FORD	8430-8630-8830	1930544	
27459		5610S, 5640, 6610S, 6640, 66400, 6810S, 7010-8010, 7610S, 7740, 77400, 7810S, 8160, 8260, 8360, 8560, 8670 - 8670A, 8770 - 8770A, 8870 - 8870A, 8970 - 8970A, SERIE 675	81879134	
35102		2000 BSD 326, 2310 BSD 326, 2600 BSD 326, 2610>01.81 BSD 329, 2610>01.82 BSD 329, 2810 BSD 326, 2910 BSD 329, 3000 BSD 329, 3055 BSD 331, 3230 BSD 332, 3430 BSD 332, 3600 BSD 329, 3610>01.81 BSD 332, 3610>01.82 BSD 332, 3900 BSD 332, 3910 BSD 332, 3910 H BSD 332, 3930 BSD 333, 3930 H BSD 332, 4000 BSD 333, 4100 BSD 331, 4110>01.81 BSD 333H, 4110>01.82 BSD 333H, 4130 BSD 333, 4130 H BSD 333, 4600 BSD 333H, 4610 H BSD 333, 4610>01.81 BSD 333H, 4610>01.82 BSD 333H, 4630 BSD 333H, 4830 BSD 442, 5000 4/68< BSD 442, 5000 <3/68 BSD 348, 5030 BSD 442, 5110 BSD 444, 550 BSD 333H, 555 BSD 333H, 555 A BSD 333, 555 B BSD 333, 555 C BSD 444, 5600 10/80< BSD 444, 5600<09/80 BSD 442, 5610 BSD 444, 5700 10/80< BSD 444, 5700<09/80 BSD 442, 5900 BSD 444, 6410 BSD 444, 655 BSD 444, 655 A BSD 444, 655 C BSD 444, 6600 10.80> BSD 444, 6600>09.80 BSD 444, 6610 BSD 444, 6700 BSD 444, 6710>09.80 BSD 444, 6710>10.80 BSD 444, 6810 BSD 444TS, 7410 BSD 444T	83933906, 83963906, 84259320, 87800068	
35098			80457412	
02041	IVECO	8061 125	1901929	
10499		8045-8065	1931047	
53222	JOHN DEERE	SERIE 5510 - 5515 - 6010	RE59754	
51832		1020, 1030, 1040, 1120, 1130, 1140, 1350, 1550, 1630, 1640, 1750, 1850, 1950, 2020, 2030, 2040, 2040s, 2140, 2250, 2550, 2650, 2850, 3020, 3030, 3040, 3050, 3100, 3130, 3140, 3200, 3300, 3350, 3400, 3640, 3650, 4020, 4030, 4040, 4040S, 4050 6359, 5000-5310-5315-5410, 6000, 6100, 6200, 6300, 6400, 6500, 6600, 6800, 6900, 820, 830, 840, 920, 930, 940, GOLDONI MOTOR J.DEERE 3 E 4CIL	T19044	
85521		SERIE 4055, SERIE 7010, SERIE 8000, SERIE 8010	RES7394	

Art./Ref.	Brand	Applicazione/Application	Rif. Orig./Orig. Ref.	Immagine/Image
85522		SERIE 5020, SERIE 5M, SERIE 6020, SERIE 6030, SERIE 6M, SERIE 6R, SERIE 7430, SERIE 7530, SERIE SE6020	RE504836	

**FILTRI OLIO MOTORE ORIGINALI JOHN DEERE**

FILTRE A HUILE ORIGINAL JOHN DEERE  
 OIL FILTERS ORIGINAL JOHN DEERE  
 OELFILTER ORIGINAL JOHN DEERE  
 FILTROS ACEITE ORIGINAL JOHN DEERE

Art./Ref.	Brand	Rif. Orig./Orig. Ref.
JDRE519626	JOHN DEERE	RE518977, RE519626
JDRE504836		RE504836, RE541420
JDRE509672		RE509672
JDAL203061		AL203061
JDRE57394		RE57394
JDRE59754		RE59754
JDJDT19044		T19044

**FILTRO OLIO ADATTABILE LANDINI**

FILTRE A HUILE ADAPTABLE LANDINI  
 OIL FILTER ADPTABLE LANDINI  
 OELFILTER PASSEND ZU LANDINI  
 FILTRO ACEITE ADAPTABLE LANDINI

Art./Ref.	Brand	Applicazione/Application	Rif. Orig./Orig. Ref.	Immagine/Image
08250	LANDINI	ADVANTAGE CABINATO: 65F, ADVANTAGE CABINATO: 65GT, ADVANTAGE CABINATO: 65L, ADVANTAGE CABINATO: 75F, ADVANTAGE CABINATO: 75GT, ADVANTAGE CABINATO: 75L, ADVANTAGE CABINATO: 85F, ADVANTAGE CABINATO: 85GT, ADVANTAGE CABINATO: 85L, ADVANTAGE CABINATO: L95GT, ADVANTAGE F.S: 65FP/LP/GT, ADVANTAGE F.S: 75FP/LP/GT, ADVANTAGE F.S: 85FP/LP/GT, ATLAS: 100, ATLAS: 70, ATLAS: 75, ATLAS: 80, ATLAS: 85, ATLAS: 90, BLIZZARD: 65, BLIZZARD: 75, BLIZZARD: 85, BLIZZARD: 95, CINGOLATI C:C6500, CINGOLATI C:C6830, CINGOLATI C:C7800, CINGOLATI C:C7830, CINGOLATI C:C8860, CINGOLATI: CF6830, FRUTTETI 530 F/L/V: 6530 F/L/V, FRUTTETI 530 F/L/V: 7530 F/L, FRUTTETI 560 F/L/V: 6560 F/L/V, FRUTTETI 560 F/L/V: 7560 F/L, FRUTTETI 560 F/L/V: 8560 F/L, GHIBLI: 100, GHIBLI: 80, GLOBUS: 55, GLOBUS: 65, GLOBUS: 75, GLOBUS: 80, LARGE: 14500, LARGE: 16000, LARGE: 16500, LEGEND N/G TDI: 125, LEGEND N/G TDI: 135, LEGEND N/G TDI: 145, LEGEND N/G TDI: 165, LEGEND N/G TDI: 185, MYTHOS NEW TIER 2: 115, MYTHOS: 100, MYTHOS: 90, POWER FARM: 60, PRIMI MODELLI 8000R-DT-S, REX CABINATI: 100, REX CABINATI: 60, REX CABINATI: 70, REX CABINATI: 80, REX CABINATI: 90, REX FOOT STEP: 100FP-LP-GTP-GE, REX FOOT STEP: 60FP-LP-GE, REX FOOT STEP: 70FP-LP-GTP-GE, REX FOOT STEP: 80FP-LP-GTP-GE, REX FOOT STEP: 90FP-LP-GTP-GE, REX NEW TIER 2: 60 F/GE, REX NEW TIER 2: 70 F/GE, REX NEW TIER 2: 75 F/GT/GE, REX NEW TIER 2: 80 F/GE, REX NEW TIER 2: 85 F/GT/GE, SERIE 30: 6830, SERIE 30: 7830, SERIE 30: 8830, SERIE 40: 6840, SERIE 500: 6500, SERIE 500: 7500, SERIE 500: 8500, SERIE 50: 6550, SERIE 50: 7550, SERIE 50: 8550, SERIE 60 NEW: 5860, SERIE 60 NEW: 6860, SERIE 60 NEW: 7860, SERIE 60 NEW: 8860, SERIE 60: 6860, SERIE 60: 7860-7860HC, SERIE 60: 8860-8860HC, SERIE 60: 9060, SERIE 70: 6870, SERIE 70: 7870, SERIE 70: 8870, SERIE 80: 6880, SERIE 80: 7880, SERIE 80: 8880-8880HC, SERIE 80: 9080-9080HC, SERIE 80: 9880-9880HC, TREKKER NEW 100C, TREKKER NEW 70 C/F/L, TREKKER NEW 80 C/F/L, TREKKER NEW 90 C/F/L, TREKKER: C75, TREKKER: C85, TREKKER: C95, TREKKER: CF65, TREKKER: CF70, TREKKER: CF75, TREKKER: CF85, VIGNETI CABINA V.Q: 65V, VIGNETI CABINA V.Q: 75V, VIGNETI F.S: 65V, VIGNETI FOOT STEP: 75V, VIGNETI REX CAB.TIER 2: 75V, VIGNETI REX CAB.TIER 2: 85V, VIGNETI REX CAB: 60V, VIGNETI REX CAB: 70V, VIGNETI REX CAB: 80V, VISION: 100, VISION: 80, VISION: 90	2654403, 2654404, 2654405, 3540049M91, E3540049M91	

Art./Ref.	Brand	Applicazione/Application	Rif. Orig./Orig. Ref.	Immagine/Image
11257	LANDINI	ADVANTAGE CABINATO:55F, ADVANTAGE CABINATO:55GT, ADVANTAGE CABINATO:55L, ADVANTAGE CABINATO:60F, ADVANTAGE CABINATO:60GT, ADVANTAGE CABINATO:60L, ADVANTAGE FOOT STEP:55FP-LP-GT, ADVANTAGE FOOT STEP:60FP-LP-GT, BLIZZARD:50, BLIZZARD:60, CINGOLATI :CF4830, CINGOLATI :CF5030, CINGOLATI :CF5830, CINGOLATI :CF6030, CINGOLATI :CF6060, CINGOLATI C:C4500, CINGOLATI C:C4830, CINGOLATI C:C5000, CINGOLATI C:C5500, CINGOLATI C:C5830, CINGOLATI C:C6000, FRUTTETI 530 F-L-V:4530V, FRUTTETI 530 F-L-V:5530 F-L-V-, FRUTTETI 530 F-L-V:6030 F-L-V-, FRUTTETI 560 F-L-V: 4560V, FRUTTETI 560 F-L-V: 5560 F-L-V, FRUTTETI 560 F-L-V: 6060 F-L-V, GLOBUS:50, PRIMI MODELLI 4000 SPECIAL, PRIMI MODELLI 5000R-DT-S-N, SERIE 30:5830, SERIE 30:6030, SERIE 40:5840, SERIE 40:6040, SERIE 500:5500, SERIE 60:5860, SERIE 60:6060, SERIE 70:5870, SERIE 70:6070, TREKKER C.F. :CF55, TREKKER C.F. :CF60, VIGNETI CABINA V.Q: 55V, VIGNETI CABINA V.Q: 60V, VIGNETI FOOT STEP:55V, VIGNETI FOOT STEP:60V	2654408, 3541579M1, E3541579M1	
11259		CINGOLATI C:C10500, GHIBLI NEW TIER 2:105, GHIBLI NEW TIER 2:85, GHIBLI NEW TIER 2:95, LARGE:10000, LARGE:10000S, LARGE:12500, LARGE:13000, LEGEND N/G:115, LEGEND N/G:120, LEGEND N/G:130, LEGEND N/G:140, LEGEND N/G:160, LEGEND N/G:180, LEGEND:105, LEGEND:115, LEGEND:130, LEGEND:145, LEGEND:165, MYTHOS NEW TIER 2:105, MYTHOS:110, POWER FARM:105, POWER FARM:75, POWER FARM:85, POWER FARM:95, REX NEW TIER 2 :105 F-GT-GE, REX NEW TIER 2 :95 F-GT-GE, SERIE 500:9500R-DT, TREKKER NEW TIER 2:105, TREKKER NEW TIER 2:75, TREKKER NEW TIER 2:85, TREKKER NEW TIER 2:95, VISION NEW TIER 2: 105, VISION NEW TIER 2: 85, VISION NEW TIER 2: 95, VISION:100	2654407, 3541580M1, E3541580M1	
11265		CINGOLATI C:C4500, CINGOLATI C:C5000, CINGOLATI C:C5500, CINGOLATI C:C6000, PRIMI MODELLI 4000 R-DT, PRIMI MODELLI 4000 SPECIAL, PRIMI MODELLI 4500 R, PRIMI MODELLI 5000R-DT-S-N, PRIMI MODELLI 6000R-DT-S, PRIMI MODELLI 7000R-DT, SERIE 500:5500	26540132	
11266		CINGOLATI C:C6500, PRIMI MODELLI 7000 SPECIAL, PRIMI MODELLI 8000R-DT-S, SERIE 500:6500, SERIE 500:7500, SERIE 500:8500	26560090	

**FILTRI OLIO MOTORE ORIGINALI LANDINI**

FILTRE A HUILE ORIGINAL LANDINI  
 OIL FILTERS ORIGINAL LANDINI  
 OELFILTER ORIGINAL LANDINI  
 FILTROS ACEITE ORIGINAL LANDINI



Art./Ref.	Brand	Rif. Orig./Orig. Ref.
LN3540049M91	LANDINI	3540049M91
LN3678034M2	LANDINI	3678034M2
LNE3541579M1	LANDINI	E3541579M1
LNE3541580M1	LANDINI	E3541580M1

**FILTRI OLIO ADATTABILI MASSEY FERGUSON**

FILTRE A' HUILE MASSEY FERGUSON

OIL FILTER ADAPTABLE MASSEY FERGUSON

OELFILTER PASSEND ZU MASSEY FERGUSON

FILTRO ACEITE ADPTABLE MASSEY FERGUSON

Art./Ref.	Brand	Applicazione/Application	Rif. Orig./Orig. Ref.	Immagine/Image
<b>08250</b>	<b>MASSEY FERGUSON</b>	1080 A4.318, 165 A4.212, 168 A4.236, 175 A4.236, 178 A4.248, 185 A4.248, 265 A4.236, 2680 AT6.354.4, 2685 AT6.354.4, 2720 AT6.354.4, 2725 AT6.354.4, 275 A4.236, 285 A4.248, 285 A4.318, 290 A4.248, 294 A4.248, 298 A4.318, 3050 A4.236, 3060 A4.248, 3065 A4.236, 3070 A4.236, 3125 1006.6T, 3140 1006.6T, 362 A4.236, 3630 AT6.534.4, 3635 1006.6T, 3645 AT6.354.4, 365 A4.236, 3650 AT6.354.4, 3655 1006.6T, 3660 1006.6T, 372 A4.236, 375 A4.236, 382 A4.248, 390 A4.248, 390T A4.236, 398 A4.236, 4225 1004.4, 4225 4.41, 4235 1004.4, 4235 4.41, 565 A4.236, 575 A4.236, 590 A4.248, 595 A4.318, 6110 4.41, 6120 4.41, 675 A4.236, 690 A4.248, 698 A4.318, 698T A4.236, 8120 1006.6T <F, 8130 1006.6T	1447048M1, 2862642M1, 836064M91, 881304M91	
<b>11257</b>		135 AD3.152, 148 AD3.152, 155 AD4.203, 158 AD4.203, 165 AD4.203, 230 AD3.152, 235 AD3.152, 240 AD3.152, 250 AD3.152, 255 AD3.152, 260 AD4.203, 340 AD3.152, 342 AD3.152, 35 A3.152, 350 AD3.152, 352 AT3.152, 355 AT3.152, 360 AT3.152, 550 AD3.152, 560 AD4.203, 65 A4.203, 65 AD4.203, 765 AD4.203	1447082M91, 3638848M1	
<b>11259</b>		1100 A6.354.1, 1105 A6.354.4, 1135 A6.354.4, 1200 A6.354.1, 1250 A6.354.4, 2620 A6.354.4, 2625 A6.354.4, 2640 A6.354.4, 2645 A6.354.4, 2680 AT6.354.4, 3075 1004.4, 3075 A4.236, 3080 A6.354.4, 3085 1006.6, 3090 A6.354.4, 3095 1006.6, 3115 1006.6, 3120 1006.6T, 3120T 1006.6T, 3125 1006.6T, 3140 1006.6T, 3610 A6.354.4, 3635 1006.6T, 3645 1006.6T, 399 1006.6, 399 A6.354.4, 4245 1004.4T, 4255 1004.4T, 4255 4.41, 4260 1006.6, 4270 1006.6, 6130 1004.4T, 6140 1004.4T, 6150 1004.4T, 6160 1006.6, 6160 1006.6T, 6170 1006.6, 6170 1006.6T, 6180 1006.6T, 6190 1006.6T, 699 A6.354.4, 8110 1006.6T, 8120 1006.6T FO	1447031M1, 1447031M2	
<b>11265</b>		135 AD3.152, 148 AD3.152, 155 AD4.203, 158 AD4.203, 165 AD4.203, 35 A3.152, 65 A4.203, 65 AD4.203, 765 AD4.203	1640996M91, 1852251M91, 1854766M1, 185766M1, 1881842M1, 1883258M91, 835568M91, 835568M92, 837595M91, 852251M91, 894972M91, 894975M91, 968614M91, 973118M91	
<b>11266</b>		1080 A4.318, 165 A4.212, 168 A4.236, 175 A4.236, 178 A4.248, 185 A4.248	1882916M1, 1896000M91	
<b>40322</b>		FE35 4cil 23C, TEF20 4cil 20C	894976M91	
<b>40323</b>		M10 SERIE 31, MF100 SERIE 630 (MD630), MF100 SERIE 630S (MD630S)	26541054	

Art./Ref.	Brand	Applicazione/Application	Rif. Orig./Orig. Ref.	Immagine/Image
40428	MASSEY FERGUSON	1100 A6.354.1, 1105 A6.354.4, 1135 A6.354.4, 1200 A6.354.1, 1250 A6.354.4, 2620 A6.354.4, 2625 A6.354.4, 2640 A6.354.4, 2645 A6.354.4, 2680 AT6.354.4, 3075 1004.4, 3075 A4.236, 3080 A6.354.4, 3085 1006.6, 3090 A6.354.4, 3095 1006.6, 3115 1006.6, 3120 1006.6T, 3120T 1006.6T, 3610 A6.354.4, 3645 1006.6T, 399 1006.6, 399 A6.354.4, 4245 1004.4T, 4255 1004.4T, 4255 4.41, 4260 1006.6, 4270 1006.6, 6130 1004.4T, 6140 1004.4T, 6150 1004.4T, 6160 1006.6, 6160 1006.6, 6170 1006.6, 6170 1006.6T, 6180 1006.6T, 6190 1006.6T, 699 A6.354.4, 8110 1006.6T	185233M1, 26540153	
40675		VARIOUS APPLICATION 60>90HP		
40665		365 A4.236, 375 A4.236, 390 A4.236	1696011M92	-
02039	NEW HOLLAND	3300L MIETITREBBIA LAVERDA, 3300R MIETITREBBIA LAVERDA, 3400 MIETITREBBIA LAVERDA, 3400R MIETITREBBIA LAVERDA, SB52 BRAUD VENDEMMIATRICI, SB54 BRAUD VENDEMMIATRICI, TK55-65F, TK55-65M, TK55-65V, TK55-75F, TK55-75M, TK55-75V, TK55-85F, TK55-85V, TK60-65, TK60-65M, TK60-65V, TK60-75, TK60-75M, TK60-75V, TK60-85F, TK60-85V, TK62-85, TK62-85M, TK70-65, TK70-65M, TK70-75, TK70-75M, TK72-85, TK72-85M, TK80-65, TK80-75, TK82-85M, TK85-55, TL100, TL65, TL70, TL80, TL90	1909101	
02041		3300AL MIETITREBBIA LAVERDA, 3400 MIETITREBBIA LAVERDA, 3400R MIETITREBBIA LAVERDA, 3500 MIETITREBBIA LAVERDA, 3500R MIETITREBBIA LAVERDA, 3550 MIETITREBBIA LAVERDA, 3550R MIETITREBBIA LAVERDA, L60, L65, L75, L85, L95, LB75 TERNA GOMMATA, LB75C TERNA GOMMATA, LM 410 SOLLEVATORE TELESCOPICI, LM 420 SOLLEVATORE TELESCOPICI, LM 425 SOLLEVATORE TELESCOPICI, LM 430 SOLLEVATORE TELESCOPICI, LM 630 SOLLEVATORE TELESCOPICI, LM 640 SOLLEVATORE TELESCOPICI, SB33 BRAUD VENDEMMIATRICI, SB35 BRAUD VENDEMMIATRICI, SB53 BRAUD VENDEMMIATRICI, SB55 BRAUD VENDEMMIATRICI, SB56 BRAUD VENDEMMIATRICI, SB58 BRAUD VENDEMMIATRICI, SB60 BRAUD VENDEMMIATRICI, SB62 BRAUD VENDEMMIATRICI, SB64 BRAUD VENDEMMIATRICI, TD55D, TD65D, TD75D, TD85D, TK100-55 CINGOLATO, TK88-85M CINGOLATO, TK95-55 CINGOLATO, TL100, TL55F, TL60, TL60E, TL65, TL65A, TL65F, TL70, TL75, TL75E, TL75F, TL80, TL85, TL85E, TL95, TL95E	84221215	
10499		3500 MIETITREBBIA LAVERDA, 3500R MIETITREBBIE LAVERDA, 3550 MIETITREBBIA LAVERDA, 3550AL MIETITREBBIA LAVERDA, 3550R MIETITREBBIE LAVERDA, 3560AL MIETITREBBIA LAVERDA, 3650 MIETITREBBIA LAVERDA, 3650R MIETITREBBIE LAVERDA, 3750 MIETITREBBIA LAVERDA, 3750R MIETITREBBIE LAVERDA, L517-L518-L520 MIETIT. LAVERDA, SB33 BRAUD VENDEMMIATRICI, SB35 BRAUD VENDEMMIATRICI, SB36 BRAUD VENDEMMIATRICI, SB52 BRAUD VENDEMMIATRICI, SB53 BRAUD VENDEMMIATRICI, SB54 BRAUD VENDEMMIATRICI, SB55 BRAUD VENDEMMIATRICI, SB56 BRAUD VENDEMMIATRICI, SB58 BRAUD VENDEMMIATRICI, SB60 BRAUD VENDEMMIATRICI, SB62 BRAUD VENDEMMIATRICI, SB64 BRAUD VENDEMMIATRICI	1931047	
15403		-	84588864	
15405		MX240-MX240R MIETIT LAVERDA, TK160-55	1930544	
27459		AL519 MIETITREBBIA LAVERDA, AL59 MIETITREBBIA, L411 MIETITREBBIA LAVERDA, L413 MIETITREBBIA LAVERDA, L416 MIETITREBBIA LAVERDA, L516 MIETITREBBIA LAVERDA, LX985 MINI PALE, M100, M115, M135, M160, TC52 MIETITREBBIA, TC54 MIETITREBBIA, TC56 MIETITREBBIA, TF76 MIETITREBBIA, TM110, TM115, TM120, TM125, TM130, TM135, TM140, TM150, TM155, TM165, TM175, TM180, TM190, TR87 MIETITREBBIA ROTATIVA, TR88 MIETITREBBIA ROTATIVA, TR97 MIETITREBBIA ROTATIVA, TS100, TS110, TS115, TS120, TS80, TS90, TV140, TX34 MIETITREBBIA, TX62 MIETITREBBIA, TX63 MIETITREBBIA, TX64 MIETITREBBIA, TX65 MIETITREBBIA, TX66 MIETITREBBIA, TX67 MIETITREBBIA, TX68 MIETITREBBIA	81879134	



Art./Ref.	Brand	Applicazione/Application	Rif. Orig./Orig. Ref.	Immagine/Image
35102	NEW HOLLAND	345D TERNA GOMMATA, 420 TERNA GOMMATA, 445C - 555C - 655C TERNA GOMMATA, 445D TERNA GOMMATA, 545D TERNA GOMMATA, 550 - 555 - 535 TERNA GOMMATA, 555B TERNA GOMMATA, 555D TERNA GOMMATA, 575D TERNA GOMMATA, 655 - 655A TERNA GOMMATA, 655D TERNA GOMMATA, 675D TERNA GOMMATA, L 781 MINI PALE, L 783 MINI PALE, L 785 MINI PALE, L 865 MINI PALE, LS180 SKID STEER LOADER, LX885 - LX865	84259320, 87800068	
35098		-	84237958	-

**FILTRI OLIO MOTORE ORIGINALI CNH**
*FILTRE A HUILE ORIGINAL CNH*
*OIL FILTERS ORIGINAL CNH*
*OELFILTER ORIGINAL CNH*
*FILTROS ACEITE ORIGINAL CNH*

Art./Ref.	Brand	Rif. Orig./Orig. Ref.
NH1909101	NEW HOLLAND	1909101
NH1909102		1909102, 84221215
NH1909104		1909104, 47456137
NH1930544		1930544
NH1931047		1931047
NH1931048		1931048
NH47135703		47135703
NH81879134		81879134
NH84228488		2854749, 84228488
NH84588864		1909123, 84588864
NH87679598		87679494, 87679598
NH87800068		84259320, 87800068
NH528493R3		528493R3
NH87800918		87800918

**FILTRO OLIO ADATTABILE**
*FILTRE A' HUILE ADAPTABLE*
*OIL FILTER ADAPTABLE P*
*OELFILTER PASSEND ZU*
*FILTRO ACEITE ADAPTABLE*

Art./Ref.	Brand	Applicazione/Application	Rif. Orig./Orig. Ref.	Immagine/Image
08250	PERKINS	1004.40, 1004.40T, 1006.60, 1006.60T, 1103A-33, 1103A-33T, 1103C-33, 1103C-33T, 4.108, 4.212, 4.236, 900, T4.236, T6.354	2654403, 2654404, 2654405	
11257		SERIE MOTORI 3.152 E 3.1254 T	2654408	
11259		1004.40T, 1004.42, 1006.60, 1006.60T, 1104A-44, 1104A-44T, 1104C-44, 1104C-44T, 1104C-44TA, 1104D-44, 1104D-44T, 1104D-E44T, 1104D-E44TA, 4.108, 4.236, 6.354.4, T6.354.2, TV8.540, V8.540	2654407	

Art./Ref.	Brand	Applicazione/Application	Rif. Orig./Orig. Ref.	Immagine/Image
11265	PERKINS	A3.152, A4.192, A4.203, D3.152, DA.203	26540132, 32527	
11266		A4.212, A4.236, A4.248	26560090	
40322		AD-4.203	26540218	
40323		4.107A - 4.107M - 4.107V, 4.108 - 4.108M - 4.108V, 6.354 - 6.354.1 - 6.354.2, 6.354.2 - 6.354T/M/H/TA/V, A6.354 - H6.354V, T4.108 - 4.248.1A, V8.510	101606, 26540154, 26541054	
40428		C8.540	26540153	
70574		704.03	2654412	

**FILTRI OLIO MOTORE ORIGINALI PERKINS**

FILTRE A HUILE ORIGINAL PERKINS  
 OIL FILTERS ORIGINAL PERKINS  
 OELFILTER ORIGINAL PERKINS  
 FILTROS ACEITE ORIGINAL PERKINS

Art./Ref.	Brand	Rif. Orig./Orig. Ref.
PK140517050	PERKINS	140517050
PK2654403		2654403
PK2654407		2654407
PK2654408		2654408



**FILTRO OLIO ADATTABILE**

FILTRE A' HUILE ADAPTABLE

OIL FILTER ADAPTABLE

OELFILTER PASSEND ZU

FILTRO ACEITE ADAPTABLE

Art./Ref.	Brand	Applicazione/Application	Rif. Orig./Orig. Ref.	Immagine/Image
<b>08250</b>	<b>RENAULT</b>	103.14TX-103.14RS-106.14TX, 103.14TX-110.14TX-113.14TX, 106.14RS-321.4-421M, 113.12FS-113-14FS, 113.12TX-113.14TX, 113.14TS-133.14TX-145.14TX, 486-489-496, 75.12RS-75.12TS-75.14TS, 80.12-80.14-96.12-95.14-91.15, 95.12-103.12TX-103.12RS, R1181.4-68.12RS-68.14RS, R1451.4-R1451 TURBO, R651-R651S-R651.4-R652-R656, R681-R701.4F-R751-R752-R781, R781.4-R921-R951-R981-R782, R85.14LS-R95.12TX-R891-R921, R851-R851.4-R851.4S, R851-R95.14TX-R85.12LS, R90S-R90V-R90VE-R490S, R91TP-R94-R490-R98-R496-R555, R95.12TX-70.12SP-70.14SP, R95.14TX-R85.12LS-R85.14LS, R951.4-R981.4-R1151.4-R1181	770129280	
<b>11257</b>	<b>RENAULT</b>	501-4, 601-4	7701028406	
<b>26782</b>			7701029280	
<b>40322</b>		Super 7, Super 7D	0122672800	
<b>40428</b>		385	7701015133	
<b>59837</b>		MASTER 2, MASTER 4X4, R385 ALFA, R55, R57 - R88, SUPER 4 - SUPER 5, SUPER 5D	0854838600	
<b>59843</b>		R50-R51-R56-R60-R70-R80-R82, R53, R86-R456-R460-R486	7701002178	
<b>02039</b>		<b>SAME</b>	BUFFALO 120 2RM-4RM, BUFFALO 130, DRAGO 100	2.4419.170.1
<b>02041</b>	ANTARES 100, ANTARES 130, ARGON 70, ASTER 70, DORADO, DORADO CLASSIC, DORADO F, DORADO S, EXPLORER II SPECIAL, EXPLORER T-TB, KRYPTON, KRYPTON F, LASER, LEOPARD 90 TURBO, ROW CROP 90, RUBIN 120, RUBIN 135, RUBIN 150, SILVER 100.4, SILVER 110, SILVER 130, SILVER 90		2.4419.340.0/10	

15403		ARIETE 137	2.4419.041.1	
26781	SAME	ARIETE 137, DELFINO 32, DELFINO 35, DELFINO 35 FRUTTETO, FOX 35 - 45 -55, SIRENETTA, VIGNERON 35 - 45 - 50	2.4419.140.1	
26782		CONDOR C, MINITAURO 60, MINITAURO 60 FRUTTETO, MINITAURO C, RANGER 45, RANGER 45 FRUTTETO, SATURNO 80, SOLAR 50	2.4419.150.1	
26778			0.041.1556.0	

02051	SAME LAMBORGHINI HURLIMANN	70C ERGOMATIC, 75C ERGOMATIC, ARGON 50 - 60, ASTER 60, ASTER 70 TURBO, C554-C554 COMPACT ERG LAMBORG, C664-C660 F-V LAMBORGHINI, C674.70 ERGOMATIC LAMBORGHINI, C774.80 ERGOMATIC LAMBORGHINI, CENTAURO 70 - 70 SYNCRO, CENTURION 75, CONDOR 55 - 55 SYNCRO, CONDOR C, CORSARO 60, CORSARO 70 - 70 SYNCRO DT, CORSARO 70 FRUTTETO, CRONO 50 - 60, EXPLORER 55 - 60 - 60 II, EXPLORER 60 DT - FRUTTETO, EXPLORER 60 SPECIAL, EXPLORER 65C ERGOMATIC, EXPLORER 70 - 70C SPECIAL, EXPLORER 70C - 80C - 90C, EXPLORER 75 FRUTTETO, EXPLORER 80 II, EXPLORERE 65 - 75, EXPLORERE 80 SPECIAL - BASSO, FALCON C, FRUTTETO 60, GOLDEN 60 - 65 - 75 - 85, H372-H372DT HURLIMANN, H468-H468 CLUB HURLIMANN, H476-H476 FRUTTETO HURLIMANN, H478-H478.4-H478 PRESTIGE HURL, LEOPARD 85 - 85 EXPORT, LEOPARD C, MERCURY 85 EXPORT - SPECIAL, MINITAURO 60 - 60C FRUTTETO, MINITAURO 60 SYNCRO, R1106-R1106DT LAMBORGHINI, R240 LAMBORGHINI, R345-C554-R660-R660DT LAMBORG, R574.60N-R674.70N LAMBORGHINI, R600-R600DT-R684-C684 LAMBORG, R653-R654-R654DT LAMBORGHINI, R674.70 GRAN PRIX LAMBORGHINI, R674.70 LAMBORGHINI, R683 LAMBORGHINI, R700-R700DT LAMBORGHINI, R754-R754DT-R754 ERGOM LAMBOR, R774.80-R774.80 GRAN PRIX LAMB, R775 F-V LAMBORGHINI, R775 FRUTTETO LAMBORGHINI, R784-C784-R854-R854DT LAMBORG, R956-R956DT LAMBORGHINI, R956.100 LAMBORGHINI, ROW CROP 80 - 85, SATURNO 80 - SYNCRO, SILVER 80 - 90, SOLAR 55 - 55C, SOLAR COMPACT 60 - 60C ERGOMAT, VIGNERON 60 - 70	0.044.1554.0, 0.044.1567.0/10	
08250		AURORA 45 2RM - 2RM VIGNETO, C353L-C353LL LAMBORGHINI, C503-C603 LAMBORGHINI, CENTAURO 60 - CENTAURO 65, CL653-C653L LAMBORGHINI, CONDOR C, CORSARO 70, FALCON 2RM - FALCON 4RM, FALCON 50, FALCON C, FALCON CC - CL - CN, LEONE 70 - LEONE 75, MINITAURO 55, MINITAURO 60 - MINITAURO 60 F, MINITAURO C, R483 LAMBORGHINI, R500-R500DT LAMBORGHINI, RANGER 45 - RANGER 45 FRUTTETO, SOLAR 50, TAURUS C, VIGNERON 45 - VIGNERON 50	2.4419.150.1, R550DT LAMBORGHINI	
26781		C352 - C352L LAMBORGHINI, C352S - C352SL LAMBORGHINI, C483 LAMBORGHINI, R235 - R235 DT LAMBORGHINI	2.4419.140.1	

**FILTRI OLIO MOTORE ORIGINALI SAME DEUTZ FAHR**

FILTRE A HUILE ORIGINAL SAME DEUTZ FAHR

OIL FILTERS ORIGINAL SAME DEUTZ FAHR

OELFILTER ORIGINAL SAME DEUTZ FAHR

FILTROS ACEITE ORIGINAL SAME DEUTZ FAHR

Art./Ref.	Brand	Rif. Orig./Orig. Ref.
V0.041.1556.0	SAME	0.041.1556.0
V0.044.1567.0/1		0.044.1567.0/1
V02931092		02931092
V2.4419.140.1		2.4419.140.1
V2.4419.150.1		2.4419.150.1
V2.4419.340.0/1		2.4419.340.0/1
V01183574	DEUTZ	01174421, 01183574



**TABELLA COMPARAZIONI FILTRI OLIO PER CODICE AMA - ARTICOLI ADATTABILI ALLE SEGUENTI MARCHE**

TABLEU COMPARAISONS DIESEL FILTRES A HUILE POUR CODE AMA

TABLE OF OIL FILTER COMPARISONS PER AMA CODE

KRAFTSTOFF OELFILTER VERGLEICHSTABELLE NACH AMA-CODE

TABLA COMPARACIONES FILTROS ACEITE PARA CODIGO AMA

Riferimento AMA	OEM	Riferimento COOPERS FIAAM	Riferimento Tecnicar	Riferimento M+H	Riferimento Donaldson	BALDWIN	Riferimento Fleetguard	Riferimento Ufi	CLEAN	NOTE
02039	1909101	FT4670T	R179	W8005	P55-1603	BT347		23.107.01	D0821	-
02040	1909130	FT4921, FT5236	R413	W1150/2, W1160/2	P556007, P559128	BT470 B75	LF3328, LF3565 LF3587	23.227.00	D0319	-
02041	1909102	FT 4669, FT4963, FT5046	R70	W1140/1	P55-3411	BT267	LF682	23.108.00	D0242	-
02051	0.044.1567.0/10	FT4627, FT4781, FT4803, FT5085	R64	W11007	-	BT5	LF580	2312400	D0224	-
08250	2654403	FT4863, FT4863A	R405, R406	W940/24 W940/27	P55-4403	B253, BT216	LF3466, LF701	2310202, 2318100	D0225/B	KUBOTA 16543-99170 STEYR 4060757
10499	1931047	FT5018, FT5018A, FT5119, FT5120	RD3000, RD3003, RD3004, RD3103	WP1144, WP1168	P55-0226	BD232, BD322, BD323, BD7120	LF3480, LF3481, LF3583	2330000, 2330300, 2330400	DF1898	-
11257	2654408, 1447082M91	FT4876	R57	W723/3, W818/2	P55-4408	BT215, BT353	LF700	2313800	D0294	LOMBARDINI 276.2175.36
11259	2654407	FT4805	R240	W938, W950/5, W950/7	P550299, P554407	BT217, BT237, BT251	LF697, LF699, LF787	2315600	D0298	-
11265	26540132, 837595M91	FA4247	OP813	-	P550184, P779073	PT108, PT108HD	LF596	2540201	ML077	-
11266	26560090, 1882916M91	FA401/2D	OP801	H827/1n	P550183	P177, PT29	LF594	2540701, 2540702	ML013/A	-
15141	1909110	FB1234	O952	-	-	-	LF574	2001000	ML010	-
15403	1909123	FA4252	OP850	H943/2T	P551271, P779944	P235	-	25.401.00	ML018	-
15405	1930544	FT4804	R88	W1170, W1170/15	P550319, P551604	B263, BT349	-	2312000, 2312001	D0268	-
26781	2.4419.140.1	FT4512, FT4761, FT4776, FT4828, FT4828A	R171, R341, R61, R62, R84	W920, W920/12, W920/14, W920/17, W920/21, W920/22, W920/23, W920/26, W920/36, W920/6, W920/6(10), W920/7, W920/80	P550318, P550942, P550963, P551201, P551268, P551300	B163, B232, B233, B298, B34, B7152	LF3311, LF3341, LF3376, LF3377, LF3378, LF3400, LF764	2312401, 2312700, 2312702, 2312704, 2312706, 2313401, 2320100, 2329000	D0223	-
26782	2.4419.150.1	FT4905	R65	W940	-	-	-	-	D0225	-
27459	81879134	FT4777	R85	W950/17	P558250	B167, B7031, B7089, B975, BT261, BT342	LF3307, LF3316, LF4017, LF4154, LF708, LF797	23.106.00, 23.152.00, 23.152.02	D0265	HENGST H28W01
35102	87800068	FT4809	R167, R206, R48	W930, W930/20, W930/7, W930/9, W932/80W930, W930/20, W930/7, W930/9, W932/80	P550941, P552290	B229	LF3353, LF4016, LF689, LF742	-	D0339	-
37997	1930892	FT5147	R42	W719/11		B161, B199	LF716	2315100, 2327200	D0289	-
40322	894976M91, 26540218	FA4009	OP820	-	P55-0052	566	LF566	2540800	ML031	-
40323	26540154	FA4303	OP836	H1029/1n	P55-1285	P15, PT195	LF599	2542100	ML 406	-
40428	185233M1, 26540153	FA4483	OP834	H1038X	P55-0185	PT12	LF598	2544400, 2545500	ML 061	-
51832	T19044	FT4580	R78	W936/4	P55-1307	BT259	LF678	2311200	D0281	HENGST H26W01
51834	01173481	FT4653	R67	W940/18, W940/29, W940/5	ELF7680, P552297, P552819, P555680, P559418	-	-	-	D0236	HENGST H17W10
51838	01183574	FT4657	R68	W962, W962/2, W962/6, W962/8	P553771	B236, B7143, B7193	LF3413, LF3625, LF3687, LF4054	2310601	D0263	-
53202	01174420	FT4879	R309	W11102, W11102/1, W11102/15	P551102, P551310	B218	LF3658, LF4112	2314401	D0874	-
53208	3136046R93	117	-	W930/15	P55-0719	B7220	LF3415	-	D01830	HENGST H20W09
53222	RE59754	-	-	W925	-	B7125	-	-	-	-
59841	6005012109	FT4580	R78	W936/4	P55-1307	BT259	LF678	2311200	D0281	-
59843	7701002178	FA4381A	OP830	H720x	P55-1302	P107	LF779	2544200	ML029	-
70574	2654412	FT4863	R406	W930/20	-	BT7403	-	-	D0339	-
85521	RE57394	LSF5036	-	-	P55-8329	BT352	LF3317	-	-	-
85522	RE504836	-	-	-	P55-0779	B7322	LF16243	-	-	-

## 1.7.3 Filtri Idraulici Hydraulic Filters



**ama**

**Ricambi & accessori per macchine agricole**  
SPARE PARTS & ACCESSORIES FOR AGRICULTURAL MACHINE

Tutti gli articoli della presente sezione, prodotti da AMA SPA e/o da terzi per conto di AMA, sono adattabili ("non originali") alle marche indicate ai sensi di quanto previsto dal REG. CE n. 1400/2002. I diritti sui marchi citati appartengono ai legittimi proprietari ed il loro uso ha l'esclusiva finalità di consentire all'utilizzatore la comparazione dei diversi prodotti. All items of this section, manufactured by AMA SPA and/or any third party on behalf of AMA, are adaptable ("non-original") to the brands listed under the provisions of the REG. CE n. 1400/2002. The rights on the trademarks belong to their respective owners and their usage is only aimed to allow the user to compare different products.

**FILTRI IDRAULICI ADATTABILI**

FILTRE HYDRAULIQUES ADAPTABLE

HYDRAULIC FILTER ADAPTABLE

KYDRAULIC FILTER PASSEND ZU

FILTRO HIDRAULICO ADAPTABLE

Art./Ref.	Brand	Applicazione/Application	Rif. Orig./Orig. Ref.	Immagine/Image
<b>02040</b>		465C/V/F, 565C, 765C, SERIE 65 80.65C, SERIE 65 55.65C, SERIE 65 60.65C, SERIE 65 70.65C, SERIE 66 60.66/LP, SERIE 66 65.66, SERIE 66 80.66, SERIE 66 80.66/F, SERIE 66 55.66, SERIE 66 60.66, SERIE 66 70.66, SERIE 66 70.66/LP-F, SERIE 66 55.66/LP, SERIE 75 55.75C, SERIE 75 60.75C, SERIE 75 70.75C, SERIE 75 80.75C, SERIE 76 60.76/F, SERIE 76 70.76/LP-VF, SERIE 76 80.76/F, SERIE 85 55.85C, SERIE 85 60.85C, SERIE 85 88.85C, SERIE 85 72.85C, SERIE 85 82.85C, SERIE 85 62.85C, SERIE 86 72.86/LP-F, SERIE 86 82.86/LP-F, SERIE 86 62.86/F, SERIE 88 55.88, SERIE 88 60.88, SERIE 88 70.88, SERIE 88 80.88, SERIE 90 110.90, SERIE 90 100.90, SERIE 90 115.90, SERIE 90 160.90, SERIE 90 70.90, SERIE 90 85.90, SERIE 90 140.90, SERIE 90 180.90, SERIE 90 55.90, SERIE 90 60.90, SERIE 90 65.90, SERIE 90 90.90, SERIE 90 130.90, SERIE 90 115.90, SERIE 90 180.90, SERIE 90 80.90, SERIE 93 65.93, SERIE 93 72.93, SERIE 93 88.93, SERIE 93 60.93, SERIE 93 82.93, SERIE 94 72.94, SERIE 94 82.94, SERIE 94 88.94, SERIE 94 60.94, SERIE 94 65.94, SERIE 90 140.90	1909130, 1930918, 47425202, 5113297, 5136877, 84397845	
<b>08437</b>		120C, 1355C, 250 NASTRO ORO, 255,300,300DT,350,350 SPECIAL, 311C/CR,312C,315C,331RS,332C, 332RS,342,,351C,352C,, 355C, 355F,355CM, 400,420,420ST,440,440DT,455C, 411C,421,431C,441,451C, 455C,455C SUPER,460,460DT,460V, 455DAL,450,450DT/DAL/UTB, 465C,466,466DT,570DT FRUTTETO-, 480,480DT,500,500DT/S, 505C, 540,540DT,550,555,480.8,480.8D, 70CI,70R,80CA,80R, 805C, 80C, 90C, SERIE 315 DIAMANTE, SERIE 66 35.66, SERIE DIAMANTE 415C/R/CL	1909134, 4975589, 5103031, 5103130, 595924, 598416	
<b>10674</b>	<b>FIAT</b>	SERIE 66 55.66/VF, SERIE 66 56.66S, SERIE 66 60.66/LP, SERIE 66 65.66, SERIE 66 80.66, SERIE 66 80.66/F, SERIE 66 55.66, SERIE 66 60.66, SERIE 66 70.66, SERIE 66 70.66/LP-F, SERIE 66 35.66, SERIE 66 45.66, SERIE 66 55.66/LP, SERIE 66 50.66, SERIE 75 60.75, SERIE 75 70.75, SERIE 75 80.75, SERIE 76 45.76/V, SERIE 76 60.76/F, SERIE 76 70.76/LP-VF, SERIE 76 80.76/F, SERIE 85 55.85, SERIE 85 60.85, SERIE 85 88.85, SERIE 85 72.85, SERIE 85 82.85, SERIE 85 62.85, SERIE 86 70.86/V, SERIE 86 72.86/LP-F, SERIE 86 82.86/LP-F, SERIE 86 50.86/V, SERIE 86 60.86/VF, SERIE 86 62.86/F, SERIE 88 55.88, SERIE 88 60.88, SERIE 88 70.88, SERIE 88 80.88, SERIE 90 110.90, SERIE 90 100.90, SERIE 90 115.90, SERIE 90 160.90, SERIE 90 70.90, SERIE 90 85.90, SERIE 90 140.90, SERIE 90 55.90, SERIE 90 60.90, SERIE 90 65.90, SERIE 90 90.90, SERIE 90 130.90, SERIE 90 180.90, SERIE 90 80.90, SERIE 93 65.93, SERIE 93 72.93, SERIE 93 88.93, SERIE 93 60.93, SERIE 93 82.93, SERIE 94 72.94, SERIE 94 82.94, SERIE 94 88.94, SERIE 94 60.94, SERIE 94 65.94	1909143, 4997992	
<b>14907</b>		352C, 355, 455, 505, 50C OM, 555, 605	1909133, 4975588, 5103029, 567233, 598415	
<b>15111</b>		TK 160-55	1930543, 79007957, 79032229	
<b>15398</b>		1000 DT E SUPER, 100C, 1300 DT, 850 DT	1909105, 44016885, 4989579, 5101733, 5106921, 84298916	

Art./Ref.	Brand	Applicazione/Application	Rif. Orig./Orig. Ref.	Immagine/Image
15399	FIAT	SERIE 55 85.55.00, SERIE 55 95.55.00	1909106, 4998327, 5104874, 5106917	
15404		SERIE 66 55.66/VF, SERIE 66 56.66S, SERIE 66 45.66, SERIE 66 50.66, SERIE 76 45.76/V, SERIE 86 70.86/V, SERIE 86 50.86/V, SERIE 86 55.86/VF, SERIE 86 60.86/VF	1930299, 5132049, 5149815	
15409		F100 - F100 DT, F110 - F110 DT, F115 - F115 DT, F120 - F120 DT, F130 - F130 DT, F140 - F140 DT	1930828, 1930882	
02040	FORD	4030, 4230, 4430, 8430, 8630, 8830	1909130, 47425202, 84397845	
10674		3010S, 3830, 3935, 4010S, 4030, 4135, 4230, 4430, 4635, 4835, 5010S	1909143, 4997992	
15404		3435 8035.06, 3830, 3935 8035.06, 4135 8035.06	1930299, 5132049, 5149815	
15409		8160, 8260, 8360	1930882	
22673		2310 BSD 326, 2600 BSD 326, 2610>01.81 BSD 329, 2610>01.82 BSD 329, 2810 BSD 326, 2910 BSD 329, 3230 BSD 332, 3430 BSD 332, 3600 BSD 329, 3610>01.81 BSD 332, 3610>01.82 BSD 332, 3900 BSD 332, 3910 BSD 332, 3930 BSD 333, 4100 BSD 331, 4110>01.81 BSD 333H, 4110>01.82 BSD 333H, 4130 BSD 333, 4600 BSD 333H, 4610>01.81 BSD 333H, 4610>01.82 BSD 333H, 4630 BSD 333H, 4830 BSD 442, 5030 BSD 442, 5110 BSD 444, 5600 10/80< BSD 444, 5600<09/80 BSD 442, 5610 BSD 444, 5700 10/80< BSD 444, 5700<09/80 BSD 442, 6410 BSD 444, 6610 BSD 444, 6710>09.80 BSD 444, 6710>10.80 BSD 444, 6810 BSD 444TS, 7410 BSD 444T, 7600 BSD 444TS, 7610 BSD 444TS, 7700 BSD 444TS, 7710 BSD 444TS, 7810 BSD 666, 7910 BSD 666, 8210 BSD 666, 8530 BSD 666, 8630 BSD 666T, 8730 BSD 666T, 8830 BSD 666TI, TW15, TW25, TW35, TW5	83912256, 84263773	



Art./Ref.	Brand	Applicazione/Application	Rif. Orig./Orig. Ref.	Immagine/Image
27457	FORD	5640 P.S. 4.4, 6640 P.S. 5.0, 7740 P.S. 5.0T, 7840 P.S. 6.6, 8160 M100 P.S. 7.5, 8240 P.S. 7.5, 8260 M115 P.S. 7.5, 8340 9/93< P.S. 7.5T, 8340<8/93 P.S. 7.5, 8360 M135 P.S. 7.5T, 8560 M160 P.S. 7.5TI, 8670 G170 P.S. 7.5T, 8770 G190 P.S. 7.5T, 8870 G210 P.S. 7.5TI, 8970 G240 P.S. 7.5TI	81863799	
27458		5610S, 5640 P.S. 4.4, 6610S, 6640 P.S. 5.0, 6810S, 7010, 7610S, 7740 P.S. 5.0T, 7840 P.S. 6.6, 8010, 8160, 8240 P.S. 7.5, 8260, 8340 9/93< P.S. 7.5T, 8340<8/93 P.S. 7.5, 8360, 8560, TS 100 P.S. 5.0T, TS 110 P.S. 5.0T, TS 115 P.S. 6.6, TS 80 P.S. 5.0, TS 90 P.S. 5.0	81865736, 82005016	
27460		4635, 4835, 5635, 6635, 7635	1930986, 84399618, 84399618	
42699		2310 BSD 326, 2600 BSD 326, 2610>01.81 BSD 329, 2610>01.82 BSD 329, 2810 BSD 326, 2910 BSD 329, 3230 BSD 332, 3430 BSD 332, 3600 BSD 329, 3610>01.81 BSD 332, 3610>01.82 BSD 332, 3900 BSD 332, 3910 BSD 332, 3930 BSD 333, 4100 BSD 331, 4110>01.81 BSD 333H, 4110>01.82 BSD 333H, 4130 BSD 333, 4600 BSD 333H, 4610>01.81 BSD 333H, 4610>01.82 BSD 333H, 4630 BSD 333H, 4830 BSD 442, 5030 BSD 442, 5110 BSD 444, 5600 10/80< BSD 444, 5600<09/80 BSD 442, 5610 BSD 444, 5700 10/80< BSD 444, 5700<09/80 BSD 442, 6410 BSD 444, 6610 BSD 444, 6710>09.80 BSD 444, 6710>10.80 BSD 444, 6810 BSD 444TS, 7410 BSD 444T, 7600 BSD 444TS, 7610 BSD 444TS, 7700 BSD 444TS, 7710 BSD 444TS, 7810 BSD 666, 7910 BSD 666, 8210 BSD 666, 8530 BSD 666, 8630 BSD 666T, 8730 BSD 666T, 8830 BSD 666TI	83912298, D8NNB486AA	
27457	JOHN DEERE	6300, 6400, 6600, 6800, 6900, 7000-7010-7020 TRASM POWRQUAD	AL205726, RE39527	
85514		1020, 1030, 10300U, 1030VU, 1035, 1035EF, 1035EV, 1040, 1040V, 1120, 1140, 1140F, 1140V, 1350, 1520, 1530, 1550, 1630, 16300U, 1630VU, 1635, 1635EF, 1635EV, 1640, 1640F, 1641 - 1641F, 1750, 1750V, 1840, 1840F, 1850, 1850F, 1850N, 1850V, 1950, 1950F, 1950N, 2020, 2030, 20300U, 2035, 2035EF, 2040, 2040F, 2040S, 2120, 2130, 2135, 2140, 2141 - 2541 - 2941, 2150, 2155, 2240, 2250, 2250F, 2251 - 2251N - 2351, 2350, 2355, 2355N, 2440, 2450, 2450F, 2510, 2520, 2550, 2555, 2630, 2640, 2650, 2650F, 2650N, 2651 - 2951, 2750, 2755, 2850, 2940, 2950, 2955, 300B, 3010, 301A, 302, 3020, 302A, 3040, 3050, 3055, 310A - 310B, 3130, 3135, 3140, 3141 - 3641, 3150, 3155, 3255, 3340, 3350, 3351 - 3651, 3640, 3640S, 3650, 4000, 4010, 401B, 401C, 401D, 4020, 4030, 410, 4230, 4320, 440 - 440A, 440 - 440A - 440B, 440C, 4430, 444, 444C, 4455, 4520, 4620, 4630, 480C, 500C, 5010, 5020, 510, 540 - 540A, 540B, 544B - 644B, 544C, 550, 550A, 550B, 555, 555A, 555B, 570 - 570A, 570B, 6030, 640, 644C, 646 - 646B, 646C, 7020, 743, 7520, 760, 820, 830, 840, 8430, 860 - 860A, 860B, 8630, 920, 93 - 93A - 94 - 95 - 95A, 9305, 930VU, 940, 940V, JD300 - JD400, JD301 - JD401, JD310, JD380, JD480, JD480A, JD500 - JD600, JD500-A, JD544 - JD544A, JD644A, JD700, JD740, JD760	AR75603	
85520		SERIE 5020, SERIE 5R, SERIE 5RN, SERIE 6000, SERIE 6010, SERIE 6020	AL118036	

Art./Ref.	Brand	Applicazione/Application	Rif. Orig./Orig. Ref.	Immagine/Image
85523	JOHN DEERE	SERIE 6000, SERIE 6005, SERIE 6010, SERIE 6020, SERIE 6030, SERIE 6M, SERIE 6R, SERIE SE6010, SERIE SE6020	AL156625	

**FILTRI IDRAULICI ORIGINALI**

FILTRE HYDRAULIQUES ORIGINAL  
 HYDRAULIC FILTERS ORIGINAL  
 HYDRAULIK FILTER ORIGINAL  
 FILTROS HIDRAULICO ORIGINAL

Art./Ref.	Brand	Rif. Orig./Orig. Ref.
JDAL118036	JOHN DEERE	AL118036
JDAL156625		AL156625
JDAL169573		AL169573
JDAR75603		AR75603
JDRE205726		RE205726



**FILTRI IDRAULICI ADATTABILI**

FILTRE HYDRAULIQUES ADAPTABLE  
 HYDRAULIC FILTER ADAPTABLE  
 KYDRAULIC FILTER PASSEND ZU  
 FILTRO HIDRAULICO ADAPTABLE

Art./Ref.	Brand	Applicazione/Application	Rif. Orig./Orig. Ref.	Immagine/Image
38563		LEGEND 105,115,130,145, LEGEND N-G 115,120,130,160,180, LEGEND N-G 140, LEGEND N-G TDI 125,135,145,165, REX V FOOT STEP 60,65,70,80, VIGNETI CAB 55,60,65,75, VIGNETI REX CAB 60V,65V,70V,80, VIGNETI REX CAB TIER 75V, 85 V	3551956M91	
41697	LANDINI	ALPINE:65, CON INVERSO MECCA, ALPINE:75, CON INVERSO MECCA, ALPINE:85, CON INVERSO MECCA, GHIBLI NEW TIER 2:105, GHIBLI NEW TIER 2:85, GHIBLI NEW TIER 2:95, GHIBLI:100, GHIBLI:80, GHIBLI:90, GLOBUS: 70, GLOBUS:50, GLOBUS:55, GLOBUS:60, GLOBUS:65, GLOBUS:75, GLOBUS:80, LEGEND N/G:115, LEGEND N/G:120, LEGEND N/G:130, LEGEND N/G:140, LEGEND N/G:160, LEGEND N/G:180, LEGEND NG/TDI:125, LEGEND NG/TDI:135, LEGEND NG/TDI:145, LEGEND NG/TDI:165, LEGEND NG/TDI:185, LEGEND: 145, LEGEND:105, LEGEND:115, LEGEND:130, LEGEND:165, MYTHOS NEW TIER 2:105, MYTHOS NEW TIER 2:115, MYTHOS:100, MYTHOS:110, MYTHOS:90, REX CAB:100, REX CAB:70, REX CAB:80, REX CAB:90, VISION NEW TIER 2:105, VISION NEW TIER 2:85, VISION NEW TIER 2:95, VISION:100, VISION:80, VISION:90	3656576M1	
41698		ALPINE:65,CON INVERSO IDRAUL, ALPINE:75, CON INVERSO IDRAU, ALPINE:85 ,CON INVERSO IDRAU, LEGEND N/G:115, LEGEND N/G:120, LEGEND N/G:130, LEGEND N/G:140, LEGEND N/G:160, LEGEND N/G:180, LEGEND NG/TDI:125, LEGEND NG/TDI:135, LEGEND NG/TDI:145, LEGEND NG/TDI:165, LEGEND NG/TDI:185, LEGEND: 145, LEGEND:105, LEGEND:115, LEGEND:130, LEGEND:165, MYTHOS NEW TIER 2:105, MYTHOS NEW TIER 2:115, MYTHOS:100, MYTHOS:110, MYTHOS:90, REX CAB:100, REX CAB:70, REX CAB:80, REX CAB:90, REX NEW TIER 2 FP CAB:105, REX NEW TIER 2 FP CAB:60, REX NEW TIER 2 FP CAB:70, REX NEW TIER 2 FP CAB:75, REX NEW TIER 2 FP CAB:80, REX NEW TIER 2 FP CAB:85, REX NEW TIER 2 FP CAB:95, VISION NEW TIER 2:105, VISION NEW TIER 2:85, VISION NEW TIER 2:95, VISION:100, VISION:80, VISION:90	3540378M1, 3619594M1	

Art./Ref.	Brand	Applicazione/Application	Rif. Orig./Orig. Ref.	Immagine/Image
58244	LANDINI	10000, 12500, 13000, 14500, 5860, 5870, 6060, 6070, 6860, 6870, 6880, 7860, 7870, 7880, 8860, 8870, 8880, 9060, 9080, 9880, ADVANTAGE: 95, ADVANTAGE:55, ADVANTAGE:60, ADVANTAGE:65, ADVANTAGE:75, ADVANTAGE:85, ATLAS:100, ATLAS:70, ATLAS:75, ATLAS:80, ATLAS:85, ATLAS:90, BLIZZARD:50, BLIZZARD:60, BLIZZARD:65, BLIZZARD:75, BLIZZARD:85, BLIZZARD:95, FRUTTETI 530:4530, FRUTTETI 530:5530, FRUTTETI 530:6030, FRUTTETI 530:6530, FRUTTETI 530:7530, FRUTTETI 530:8530, FRUTTETI 560:5560, FRUTTETI 560:6060, FRUTTETI 560:6560, FRUTTETI 560:7560, FRUTTETI 560:8560, GHIBLI NEW TIER 2:105, GHIBLI NEW TIER 2:85, GHIBLI NEW TIER 2:95, GHIBLI:100, GHIBLI:80, GHIBLI:90, POWER FARM:105, POWER FARM:60, POWER FARM:75, POWER FARM:85, POWER FARM:95, REX CAB:100, REX CAB:60, REX CAB:70, REX CAB:80, REX CAB:90, REX FOOT STEP:100, REX FOOT STEP:60, REX FOOT STEP:70, REX FOOT STEP:80, REX FOOT STEP:90, SERIE 60 NEW:5860, SERIE 60 NEW:6860, SERIE 60 NEW:7860, SERIE 60 NEW:8860, TREKKER COMPACT TIER 2:CF60, TREKKER COMPACT TIER 2:CF70, TREKKER NEW TIER 2:105, TREKKER NEW TIER 2:75, TREKKER NEW TIER 2:85, TREKKER NEW TIER 2:95, TREKKER NEW:100C, TREKKER NEW:70C/F/L, TREKKER NEW:80C/F/L, TREKKER NEW:90C/F/L, TREKKER:C75, TREKKER:C85, TREKKER:C95, TREKKER:CF55, TREKKER:CF60, TREKKER:CF65, TREKKER:CF70, TREKKER:CF75, TREKKER:CF85, VIGNETI FOOT STEP:55V, VIGNETI FOOT STEP:60V, VIGNETI FOOT STEP:65V, VIGNETI FOOT STEP:75V	3530223M92	
58247		ALPINE, ALPINE TIER 3, GLOBUS, POWERFARM RPS TIER 2, POWERFARM RPS TIER 3, POWERMONDIAL, REX CAB, REX TECHNO RESTYLING, REX TECHNO TIER 2, REX TECHNO TIER 3, REX TIER 2, REX TIER 3, REX TOP RESTYLING, SERIE 5H, TREKKER NEW, TREKKER NEW TIER 2, TREKKER NEW TIER 3, TREKKER RESTYLING, VIGNETI REX CAB TIER 2, VIGNETI REX CAB TIER 3, VISION, VISION NEW TIER 2, VISION TIER 3	3555711M91	-
70579		16500, 5500, 5830, 5840, 5860, 5870, 6030, 6040, 6060, 6070, 6500, 6550, 6830, 6840, 6860, 6870, 6880, 7500, 7550, 7830, 7860, 7870, 7880, 8500, 8550, 8830, 8860, 8870, 8880, CINGOLATI:C4500, CINGOLATI:C4830, CINGOLATI:C5500, CINGOLATI:C5830, CINGOLATI:C6500, CINGOLATI:C6830, CINGOLATI:C7800, CINGOLATI:C7830, CINGOLATI:C8860, CINGOLATI:CF4830, CINGOLATI:CF5030, CINGOLATI:CF5830, CINGOLATI:CF6030, CINGOLATI:CF6830, FRUTTETI 530:4530, FRUTTETI 530:5530, FRUTTETI 530:6030, FRUTTETI 530:6530, FRUTTETI 530:7530, FRUTTETI 530:8530, TREKKER:C75, TREKKER:C85, TREKKER:C95	3307250M91, 3386701M2	
70580		10000, 12500, 13000, 14500	3530222M91	
70584		MISTRAL AMERICA:40, MISTRAL AMERICA:45, MISTRAL AMERICA:50, MISTRAL AMERICA:55, MISTRAL:40, MISTRAL:45, MISTRAL:50, MISTRAL:55	4204121M1	
58246		-	3555858M91	-

**FILTRI IDRAULICI ORIGINALI LANDINI**

FILTRES HYDRAULIQUES ORIGINAL LANDINI

HYDRAULIC FILTERS ORIGINAL LANDINI

HYDRAULIK FILTER ORIGINAL LANDINI

FILTROS HIDRAULICO ORIGINAL LANDINI

Art./Ref.	Brand	Rif. Orig./Orig. Ref.
LN3307250M91	LANDINI	3307250M91
LN3530223M92		3530223M92
LN3551956M91		3551956M91



**FILTRI IDRAULICI ADATTABILI MASSEY FERGUSON**

FILTRE HYDRAULIQUES ADAPTABLE MASSEY FERGUSON  
 HYDRAULIC FILTER ADATABLE MASSEY FERGUSON  
 HYDRAULIC FILTER PASSEND ZU MASSEY FERGUSON  
 FILTRO HIDRAULICO ADAPTABLE MASSEY FERGUSON

Art./Ref.	Brand	Applicazione/Application	Rif. Orig./Orig. Ref.	Immagine/Image
11938	MASSEY FERGUSON	1200 A6.354.1, 1250 A6.354.4, 135 AD3.152, 148 AD3.152, 165 A4.212, 165 AD4.203, 168 A4.236, 175 A4.236, 178 A4.248, 185 A4.248, 230 AD3.152, 235 AD3.152, 240 AD3.152, 250 AD3.152, 255 AD3.152, 265 A4.236, 275 A4.236, 285 A4.248, 285 A4.318, 290 A4.248, 298 A4.318, 340 AD3.152, 35 A3.152, 350 AD3.152, 355 AT3.152, 360 AT3.152, 362 A4.236, 365 A4.236, 375 A4.236, 390 A4.248, 390T A4.236, 398 A4.236, 399 1006.6, 399 A6.354.4, 550 AD3.152, 565 A4.236, 575 A4.236, 590 A4.248, 595 A4.318, 65 A4.203, 65 AD4.203, FE35 4cil 23C	1687042M91, 1810744M91, 1870199M91, 1870199M92	
41696		340 AD3.152, 350 AD3.152, 355 AT3.152, 360 AT3.152, 362 A4.236, 365 A4.236, 375 A4.236, 390 A4.248, 390T A4.236, 398 A4.236, 399 1006.6, 399 A6.354.4	3595175M1	
41697		MF 376 CF, MF 376 XCF, MF 376C, MF 396 C, MF 396 CF, MF 396 CT	3540341M1, 3615949M1	
41698		MF3050,3060,3065,3075,3085, MF3095,3120,3125,3315,3325, MF3330,3340,3350,3355,, MF3425,3435,3445,3455 VSF POW, MF3425,3435,3445,3455 VSF TRAC, MF6120,6130,6140,6150,6160,, MF6170,6180	3540378M1, 3619594M1	
41764		230 AD3.152, 240 AD3.152, 250 AD3.152, 260 AD4.203, 265 A4.236, 275 A4.236, 285 A4.248, 285 A4.318, 290 A4.248, 298 A4.318, 340 AD3.152, 342 AD3.152, 550 AD3.152, 560 AD4.203, 565 A4.236, 575 A4.236, 590 A4.248, 675 A4.236, 698 A4.318, 698T A4.236, 699 A6.354.4	1674984M92, 1810694M92	
41767		3050 A4.236, 3060 A4.248, 3065 A4.236, 3070 A4.236, 3075 1004.4, 3075 A4.236, 3080 A6.354.4, 3085 1006.6, 3090 A6.354.4, 3095 1006.6, 3115 1006.6, 3120 1006.6T, 3120T 1006.6T, 3125 1006.6T, 3140 1006.6T, 6110 4.41, 6120 4.41, 6130 1004.4T, 6140 1004.4T, 6150 1004.4T, 6160 1006.6, 6160 1006.6T, 6170 1006.6, 6170 1006.6T, 6180 1006.6T, 6190 1006.6T, 6235, 6245, 6255, 6260, 6265, 6270, 6280, 6290	3616579M2, 3907580M1, 4303303M1	
02040	NEW HOLLAND	60-65 V, 70-75, TD60D, TD70D, TD80D, TD90D, TD95D, TK100A, TK4020F, TK4020V, TK4030, TK4030F, TK4030V, TK4040, TK4040M, TK4050, TK4050M, TK4060, TK55-65 F, TK55-65 M, TK55-65 V, TK55-75 F, TK55-75 M, TK55-75 V, TK55-85 F, TK55-85 M, TK55-85 V, TK60-65, TK60-65 M, TK60-75, TK60-75 M, TK60-75 V, TK60-85 F, TK60-85 V, TK62-85, TK62-85 M, TK65F, TK65V, TK70-65, TK70-65 M, TK70-75 M, TK70FA, TK70VA, TK72-85, TK72-85 M, TK75F, TK75FA, TK75M, TK75MA, TK75V, TK75VA, TK76, TK76M, TK80-65, TK80-66 DT, TK80-75, TK80A, TK80MA, TK82-85 M, TK85, TK85M, TK88-85 M, TK90A, TK90MA, TK95M, TT65D	1909130, 47425202, 84397845	
10674		SERIE L L65, SERIE L L60, SERIE L L75, SERIE L L85, TD55D, TD60, TD60D, TD65B, TD65D, TD70, TD70D, TD75D, TD80, TD80D, TD85D, TD90, TD90D, TD95, TD95D, TK100A, TK4020F, TK4020V, TK4030, TK4030F, TK4030V, TK4040, TK4040M, TK4050, TK4050M, TK4060, TK65F, TK65V, TK70FA, TK70VA, TK75F, TK75FA, TK75M, TK75MA, TK75V, TK75VA, TK76, TK76M, TK80A, TK80MA, TK85, TK85M, TK90A, TK90MA, TK95M, TL100, TL70, TL80, TL90, TS6000 - TS6040, TT55, TT65, TT65D, TT75	1909143, 4997992	

15399	NEW HOLLAND	TK 100-55, TK 85-55, TK 95-55	1909106	
15409		M100, M115, M135, M160, TM115, TM120, TM125, TM130, TM140	1930828, 1930882, 5148698, 5164251, 5167243	
27457		SERIE MIETITREBBIE CR TIER 2, SERIE MIETITREBBIE CR TIER 3, SERIE MIETITREBBIE CR TIER 4, SERIE MIETITREBBIE CX, SERIE T6, SERIE T7.170, SERIE T7.210, T6010, T6020, T6030, T6040, T6050, T6060, T6070, TC55 - TC57 MIETITREBBIE, TM135, TM150, TM165, TM180, TM7010, TM7020, TM7030, TM7040, TRINCIE CARICATRI SERIE FR9000, TRINCIE CARICATRICI SERIE FR, TS 100 P.S. 5.0T, TS 110 P.S. 5.0T, TS 90 P.S. 5.0, TS100A, TS110A, TS115A, TS125A, TS130A	81863799, 84226258	
27458		6010, SERIE M M100, SERIE M M115, SERIE M M135, SERIE M M160, TS.105, TS.115, TS.95, T6.120, T6.140, T6.150, T6.155, T6.160, T6.165, T6.175, T6020, T6030, T6050, T6070, TM115, TM120, TM125, TM130, TM135, TM140, TM150, TM155, TM165, TM175, TM180, TM190, TS100, TS100A, TS110, TS110A, TS115, TS115A, TS125A, TS130A, TS80, TS90	82005016, 84248043	
27460		L60, L65, L75, L85, L95, TL100, TL55F, TL60, TL60E, TL65, TL65A, TL65F, TL70, TL75, TL75E, TL75F, TL80, TL85, TL85E, TL90, TL95, TL95E	1930986, 47124379, 5171457, 84399618	
29391		T4030V, T4040V, T4050V, T4060V, TD5040, TD5050, TN55, TN55D, TN55S, TN65, TN65D, TN65F, TN65S, TN70, TN70D, TN70S, TN75, TN75D, TN75F, TN75S, TN90F	47131194, 5174044, 84257511	
41697		T4.75, T4.55, T4.65, T4020, T4020V, T4030, T4030, T4050, T4020, T4040, T4020, T4030N, T4030V, T4040F, T4030F, T4060F, T4050F, T4040N, T4040V, T4050, T4040, T4030,, TS.115-T5.95-T5.105, T5030, T5040, T5050, T5060, T5070, TD5040, TD5030, TD5050, TL90A, TL100A, TL80A, TL70A, TN60SA, TN85SA, TN70SA, TN75SA, TN60VA, TN75VA, TN70VA, TN95VA, TN70DA, TN60DA, TN70NA, TN95NA, TN75NA, TN95A, TN85DA, TN85FA, TN75FA, TN95FA, TN85SA, TN95A, TN75A, TN60A, TN70A, TN85A, TN95DA	47128161, 5194879	
42699		TC18D, TC21D, TC24D, TZ21D, TZ24D, TZ25DA	83912298	

**FILTRI IDRAULICI ORIGINALI CNH**

FILTRE HYDRAULIQUES ORIGINAL CNH  
 HYDRAULIC FILTERS ORIGINAL CNH  
 HYDRAULIK FILTER ORIGINAL CNH  
 FILTROS HIDRAULICO ORIGINAL CNH







Art./Ref.	Brand	Rif. Orig./Orig. Ref.
NH1909105	NEW HOLLAND	1909105, 84298916
NH1909106		1909106
NH1909134		1909134
NH1930986		1930986, 84399618
NH47425202		47425202
NH84257511		47131194, 84257511
NH151816113		151816113
NH1329214C1		1329214C1

**FILTRI IDRAULICI ADATTABILI**

FILTRE HYDRAULIQUES ADAPTABLE  
 HYDRAULIC FILTER ADAPTABLE  
 KYDRAULIC FILTER PASSEND ZU  
 FILTRO HIDRAULICO ADAPTABLE

Art./Ref.	Brand	Applicazione/Application	Rif. Orig./Orig. Ref.	Immagine/Image
02040	SAME	ANTARES 100, ANTARES 110, ANTARES 130, CORSARO 70 FRUTTETO, EXPLORER 75, EXPLORER 75 SPECIAL, EXPLORER 80, EXPLORER 90 II SPECIAL, EXPLORER 90 SPECIAL, GALAXY 170, LEOPARD C, ROW CROP 100, ROW CROP 90	2.4419.270.0	
38563		ANTARES 100, ANTARES 110, ANTARES 130, ANTARES II 110, ANTARES II 130, DORADO 60, DORADO 65, DORADO 70, EXPLORER 75, EXPLORER 75 SPECIAL, EXPLORER 80, EXPLORER 90 II SPECIAL, EXPLORER 90 SPECIAL, IRON, IRON COM 3, IRON CONTINUO COM 3, IRON HI-LINE, IRON HI-LINE COM 3, ROW CROP 90, SAME ROCK 55, SAME ROCK 60, SILVER 100.4, SILVER 100.6, SILVER 110, SILVER 130, SILVER 80, SILVER 90, SOLAR 50, SOLAR 55 C, SOLAR 60, SOLAR 60 C	2.4419.350.0/10	
41697		DORADO F - S - V, GOLDEN 60, GOLDEN 65, GOLDEN 75, GOLDEN 85, TITAN	2.4419.611.0	
41698		GOLDEN 60 - 65 - 75 - 85	2.4419.721.0	

<b>85468</b>	<b>SAME</b>	SERIE CENTURION, SERIE CONDOR, SERIE EXPLORER I/II, SERIE LASER, SERIE MERCURY, SERIE SILVER, SERIE SOLAR, SERIE SOLARIS	2.4419.280.0/10	
<b>85469</b>		SERIE CENTURION, SERIE EXPLORER I/II, SERIE SILVER, SERIE TITAN	2.4419.320.0/20	

Art./Ref.	Brand	Applicazione/Application	Rif. Orig./Orig. Ref.	Immagine/Image
<b>02040</b>	<b>SAME LAMBORGHINI HURLIMANN</b>	C 483 LAMBORGHINI, C 583 - C 683 LAMBORGHINI, R 483 LAMBORGHINI, R 583 - R 1156 - R 1156 DT LAM, R 683 LAMBORGHINI, R1356 - R1356 DT LAMBORGHINI, R1506 DT TURBO LAMBORGHINI, R1556 DT LAMBORGHINI, R1706 DT TURBO LAMBORGHINI, R874.90 TURBO E GRAND PRIX LAM, R955 - R1256 LAMBORGHINI	2.4419.270.0	
<b>85468</b>		SERIE H400, SERIE H5000, SERIE H6000	2.4419.280.0/10	

**FILTRI IDRAULICI ORIGINALI SAME DEUTZ FAHR**
*FILTRE HYDRAULIQUES ORIGINAL SAME DEUTZ FAHR*
*HYDRAULIC FILTERS ORIGINAL SAME DEUTZ FAHR*
*HYDRAULIK FILTER ORIGINAL SAME DEUTZ FAHR*
*FILTROS HIDRAULICO ORIGINAL SAME DEUTZ FAHR*

Art./Ref.	Brand	Rif. Orig./Orig. Ref.
<b>V2.4419.270.0</b>	<b>SAME</b>	2.4419.270.0
<b>V2.4419.280.0/1</b>		2.4419.280.0/1
<b>V2.4419.320.0/2</b>		2.4419.320.0/2
<b>V2.4419.350.0/1</b>		2.4419.350.0/1

## TABELLA COMPARAZIONI FILTRI IDRAULICI PER CODICE AMA

TABLEU COMPARAISONS FILTRE HYDRAULIQUES POUR CODE AMA

TABLE OF HYDRAULIC FILTERS COMPARISONS PER AMA CODE

LUFFILTER VERGLEICHSTABELLE NACH AMA-CODE

TABLA COMPARACIONES FILTRO AIRE PARA CODIGO AMA

Riferimento AMA	OEM	Riferimento FIAAM	Riferimento Tecnocar	Riferimento M+H	Riferimento Donaldson	UFI	Note
02040	1909130	FT4921	R413	W1150/2	P55-6007	23.227.00	-
08437	1909134	FH3499	-	-	-	22.009.00	FLEETGUARD HF6274
10674	1909143	FH1548	-	-	-	21.021.00	FLEETGUARD HF28912
11938	1870199M91	-	-	H66/3X	-	-	-
14907	1909133	FH3258	Z267	-	-	-	-
15111	1930543	-	-	-	-	-	-
15398	1909105	FA4770	OP316	-	-	25.443.00	-
15399	1909106	FA4795	OP318	-	-	25.498.00	FLEETGUARD HF6268
15404	1930299	FT5017	-	-	P550420	-	FLEETGUARD LF3547
15409	1930882	-	-	HD1044/2	-	25.552.00	FLEETGUARD HF28914
22673	83912256	-	-	-	P77-9583	-	FLEETGUARD HF6115
27457	81863799	-	R263	WH980/3	P17-0950	-	FLEETGUARD HF6553
27458	82005016	-	-	-	P50-2224	-	FLEETGUARD HF28885
27460	1930986	FT5279	-	W1160/6	P76-4638	-	FLEETGUARD HF28833
29391	84257511	-	-	-	P76-5662	-	-
38563	2.4419.350.0/10	FT4944	-	WD11001	P76-4606	8.004.100	-
41696	3595175M1	-	-	W1019	P76-2476 P55-2476	-	FLEETGUARD HF28812
41697	3656576M1	-	-	-	P16-9447	-	-
41698	3540378M1	-	-	HD513/11	P76-2756	-	-
41764	1674984M92	-	-	-	-	-	-
41767	3616579M2	-	-	W13001	P76-4260	-	-
42699	83912298	-	-	-	P55-1323	-	FLEETGUARD HF6115
53245	1907641	FA5583	-	H615	-	-	-
58244	3530223M92	-	-	H816/1	-	-	-
58247	3555711M91	-	-	-	-	-	-
70579	3307250M91	-	-	-	-	-	-
70580	3530222M91	-	-	-	-	-	-
70584	4204121M1	-	-	-	-	-	-
85468	2.4419.280.0/10	FT4948	R415	WD11002	P763987	-	-
85469	2.4419.320.0/20	FT4952	R417	WD11003	P764607	-	-
85514	AR75603	FA4995	-	H12631	P555603	-	-
85520	AL118036	-	-	WH9801	P164378	-	-
85523	AL156625	-	-	WH945	P764668	-	FLEETGUARD HF6554



# 1.7.4 Filtri Aria

Air Filters









## Ricambi & accessori per macchine agricole

SPARE PARTS & ACCESSORIES FOR AGRICULTURAL MACHINE

Tutti gli articoli della presente sezione, prodotti da AMA SPA e/o da terzi per conto di AMA, sono adattabili ("non originali") alle marche indicate ai sensi di quanto previsto dal REG. CE n. 1400/2002. I diritti sui marchi citati appartengono ai legittimi proprietari ed il loro uso ha l'esclusiva finalità di consentire all'utilizzatore la comparazione dei diversi prodotti. All items of this section, manufactured by AMA SPA and/or any third party on behalf of AMA, are adaptable ("non-original") to the brands listed under the provisions of the REG. CE n. 1400/2002. The rights on the trademarks belong to their respective owners and their usage is only aimed to allow the user to compare different products.

**FILTRI ARIA ADATTABILI**

FILTRE AIR ADAPTABLE  
AIR FILTERS ADAPTABLE  
LUFFILTER PASSEND ZU  
FILTROS AIRE ADAPTABLE

Art./Ref.	Note/Notes	Brand	Applicazione/Application	Rif. Orig./Orig. Ref.	Immagine/Image
<b>08283</b>	Esterno/Outer	<b>CASE</b>	5110 >06/90, 5120 >06/90, 5130 >06/90, 5140 >06/90, 5230	1930765	
<b>08284</b>	Interno/Inner		4230A, 4240A, CVX 120, CVX 130, CVX 150, CVX 170, MAXXUM 5120, MAXXUM 5130, MAXXUM 5140	N8153	
<b>15147</b>	L. 353 mm. Esterno/L. 353 mm. Outer		CX100, CX70, CX80, CX90	1930589, 222421A1	
<b>15148</b>	Interno/Inner		CX80, CX90, MX80C, MX90C	222422A1, CF990	
<b>15183</b>	Esterno/Outer		4230A, 4240A, MAXXUM 5120, MAXXUM 5130, MAXXUM 5140	700711907, C16335, D55864, D56453, D56463, E174631, L55204, N7698, S0850510	
<b>42174</b>	Interno/Inner		1066, 1466, 1486, 1566, 1586, 3388, 3588, 3788, 4786, 5288, 5488, 6388, 6588, 6788, 7288, 7488	81866982	
<b>42175</b>			2500D, 2504, 3514D, 504		
<b>42176</b>	L.443mm. Interno/L.443mm. Inner		1550	83913764	
<b>42177</b>	L.475mm. Esterno/L.475mm. Outer		1550	83913766	

Art./Ref.	Note/Notes	Brand	Applicazione/Application	Rif. Orig./Orig. Ref.	Immagine/Image
51846	Interno/Inner	CASE	260A, 3225, 433, 523, 523A, 533, 533A, 540, 633, 633 A/V/FWD, 640, 733, 733 A/FWD, 8045, 8045A, 8055, 8055A, 8060, 8060 A/T/TA, 8065, 8065 A, 8070, 8070 A, 8075, 8075A, 833, 840, 940, 942, 948, CS42	3148080R1	
51847	Interno/Inner		1046, 1046 A, 1055, 1055XL, 533, 544, 644, 644A, 743, 743 A/S/SA/XL/XLA, 744, 744A, 745S, 745XL, 745XL FWD, 8090, 8090 A, 8095, 8095 A, 824, 824 A, 833 N/S/XL, 844, 844 A/S/SA/XL/XLA, 844S, 844XL, 845 XL/XL FWD, 946, 946 A, 955, 955 A/XL/XLA, 956, 956 XL/XL FWD/XLA, 964, 964 A, 970, 970 A, 975, CS 55, CS 64, CS 68, CS 68A, CS 75, CS 75A	3147878R1	
51849	Esterno/Outer		260A, 3210A, 3220A, 3225, 323, 3230A, 4210A, 4220, 433, 453, 523, 523 A, 533, 533 A, 540, 624, 624 A, 633, 633 A/FWD/V, 724, 724 A, 733, 733 A/FWD, 8045, 8045 A, 8055, 8055 A, 8060, 8060 A/T/TA, 8065, 8065 A, 8070, 8070 A, 8075, 8075 A, 826, 826 A, 833, 833 A, 840, 846, 846 A, 940, 942, 948, CS 42	3142497R1, 3146927R1, C12155	
51850	Esterno/Outer		1046, 1046 A, 1055, 1055XL, 544, 644, 644A, 743, 743 A/S/SA/XL/XLA, 744, 744A, 8090, 8090 A, 8095, 8095 A, 824, 824 A, 844, 844 A/S/SA/XL/XLA, 955, 964, 964 A, 970, 970 A, 975, CS 68, CS 68A, CS 75, CS 75A	3146576R1	
53215	Interno/Inner		1055, 1055XL, 1056, 1056XL, 1102 D/PD, 1255, 1255 XL/XLA/XL FWD, 130M, 1455, 1455 XL/XLA/XL FWD/XL TURBO, 8150, 8150A, 8160, 8160A, 8165, 8165A, 8170, 8170A, 8180, 8180A, 9105A, 9115A, 9125A, 9145A, 955, 955 A/XL/XLA, 956, 956XL, CS100, CS110, CS110A, CS120, CS120A, CS130, CS150, CS150A	3219421R1	
53216	Esterno/Outer			3226416R1, C20325/2	
53975	Interno/Inner		1046, 1056, 1056XL/XLA, 1102, 1246, 1246A, 724, 8100, 8100A, 8110, 8110A, 8120, 8120A, 8130, 8130A, 8140, 8140A, 824, 856XL, 856XL TURBO, 9078 (M9078), 9083, 9086 (M9086), 9094 (M9094), 946, 955, 956 XL/XL FWD, CS78, CS86, CS94	3146939R91	
15157R	Interno/Inner			3344849R1	
15158	Interno/Inner			222422A1, CF990	
51847	Interno/Inner		CLAAS	48, DOMINATOR 38	1761700, 8248360

Art./Ref.	Note/Notes	Brand	Applicazione/Application	Rif. Orig./Orig. Ref.	Immagine/Image
53215	Interno/Inner	CLAAS	202, 203, 70SF 01/75-05/84, 80SF 01/75-05/84, CC1400, COMMANDOR 112 CS, COMMANDOR 114 CS, DOMINATOR 105, DOMINATOR 106, DOMINATOR 106S, DOMINATOR 108 S/SL, DOMINATOR 108 SL MAXI, DOMINATOR 112CS, DOMINATOR 114CS, DOMINATOR 76, DOMINATOR 76H, DOMINATOR 78S, DOMINATOR 78SL, DOMINATOR 85, DOMINATOR 85H, DOMINATOR 86, DOMINATOR 88 S/SL/VX, DOMINATOR 96, DOMINATOR 98, DOMINATOR 98 S/SL/VX, DOMINATOR 98 SL MAXI, JAGUAR 60SF, JAGUAR 675, JAGUAR 680, JAGUAR 70SF, MEGA 202, MEGA 203, MEGA II 202, MEGA II 203	176168, 940084, 942084	
53975	Interno/Inner		58 48 SPECIAL, DOMINATOR 56, DOMINATOR 58S SPECIAL, DOMINATOR 66, DOMINATOR 68, DOMINATOR 68 R/S, DOMINATOR 76, DOMINATOR 76H, DOMINATOR 78S, DOMINATOR 80,85,86,96, DOMINATOR 80H, 85H, DOMINATOR 88S/SL	6766000, 6766001	
08283	Esterno/Outer	DEUTZ	70 >02/01, 70 >03/97, 80 >02/01, AGROCOMPAKT 60AF, AGROCOMPAKT 60F, AGROCOMPAKT 60V, AGROCOMPAKT 70AF, AGROCOMPAKT 70F, AGROCOMPAKT 70V, AGROPLUS 60, AGROPLUS 70, AGROPLUS 80, AGROPLUS 87, AGROPLUS 90	2.4249.310.4	
08284	Interno/Inner		70, AGROLUX 90, AGROPLUS 87, AGROTRON 80	2.4249.130.7	
53216	Esterno/Outer		Agrostar DX6.61, D4005, D4505, D5005, D5505, DX140, DX145, DX160, DX6.50, DX7.10, Intrac 2005, Intrac 2006, Intrac 6.30 Turbo	2165049	
53215	Interno/Inner		5510, 6.05 >01/88, 6.60 >01/88, Agrostar DX6.61, DX130, DX140, DX145, DX140A, DA145A, DX160, DX160A, DX160 05/78-01/86, DX6.50, DX7.10, Intrac 6.30 Turbo, Intrac 6.60, M1600 HYDROMAT, M2385, M2480, M4030, MH650, SFH 3008, 3008A	2241329	
53238	Esterno/Outer		3.70F/V >01/87, 3.90FA/VA/S >01/87, AgroCOMPAKT 3.90 FA/VA/S, AgroPRIMA 4.51, 4.56, 6.06, Agrostar DX6.11, DX6.21, Agroxtra 4.17 (DX), Agroxtra 4.47, Agroxtra 6.17, Agroxtra 3.57, Agroxtra 4.07, Agroxtra 4.57 (DX), Agroxtra 6.07, Agroxtra 6.17, Agroxtra BF4L913, Agroxtra F6L14, Agroxtra F6L912, D10006, D12006, D13006, D6265, D7506, D7807, D7807A, D7807C, D8000, D8006, D9006 (A), DX110 (A), DX120 (A), DX3.57, DX3.60, DX3.65, DX3.70, DX3.80, DX3.70 V/F, DX3.80 V/F/S, DX3.90, DX3.90 F/S, DX4.07, DX4.10, DX4.17 (A), DX4.30, DX4.31, DX4.47, DX4.50, DX4.51, DX4.56, DX4.57 (A), DX4.70, DX6.05, DX6.06, DX6.07, DX6.10, DX6.16, DX6.17, DX6.30, DX80 (A), DX85 (A), DX86 (A), DX90 (A), DX92 (A)	2323855, 4384103, C17250	
53239	Interno/Inner		Agrostar DX6.11, D10006, D12006, D13006, D7506, D7807 (A), D8006, D9006, DX110 (A), DX120, DX6.05, DX6.07, DX6.10, DX6.30, DX85, DX86, DX90, DX92	2379163, 4308636, CF811	
53975	Interno/Inner		2006, Agrostar 6.38, Agrostar DX4.61, Agrostar DX6.11, Agrostar DX6.21, Agrostar DX6.88, Agroxtra 4.17, Agroxtra 4.47, Agroxtra 6.17, Agroxtra 4.07, Agroxtra 6.07, Agroxtra 6.17, Agroxtra BF4L913, Agroxtra F6L14, Agroxtra F6L912, DX3.57 >10/91, DX4.07 >10/91, DX4.17 >03/90, DX4.47 >03/90, DX4.57 >03/90, DX6.07 >03/90, DX6.17 >10/91, INTRAC 2005,2006, M1080, M750, M770, M980, M1002	2165044	









Art./Ref.	Note/Notes	Brand	Applicazione/Application	Rif. Orig./Orig. Ref.	Immagine/Image
53976	Esterno/Outer	DEUTZ	AgroCOMPAKT 3.30F/V, AgroCOMPAKT 3.50F/S/V, AgroCOMPAKT 3.90FA/VA/S, Agroxta 4.17, Agroxta 4.47, Agroxta 6.07, Agroxta F6L912, Agroxta 4.07, Agroxta 6.07, Agroxta 6.17, Agroxta BF4L913, Agroxta F6L13, D2506, D3006, D3607, D3607, D4007, D4507, D4807, D4006, D4206, D5506, D6006, D5207, D6207, D6507, D6907C, D6806, D7206, D7007 (C), D7207 (C), D7807A/C, D8006, DX3.10, DX3.30, DX3.50, DX3.60, DX3.10V, DX3.30V/F/S, DX3.50V/F/S, DX3.57, DX3.60, DX3.65, DX3.80, DX3.70V/F, DX3.80V/F/S, DX3.90F/S, DX36V, DX4.07, DX4.17, DX4.47, DX4.57, DX4.17 A/H, DX50, DX50V, DX55V, DX6.07, DX6.17, Intrac 2002, Intrac 2003, Intrac 2004	4384102, C17134	
51846	Interno/Inner	FENDT	240S, 250 S/SA/V/VA, 260 S/SA/V/VA, 270 V/VA, 280 S/SA/V/VA/P/PA, 345GT, 360GT, 360GTF, 360GTH, 360GTM, CF600	F345200090010	
51847	Interno/Inner		308LSA 178/01, 308LSA FWA 178/26, 365GTA, 380GHA, 380GT, 380GTA, 380GTF, 60, CF600, CF700, FARMER 303 LS, FARMER 304 LS/LA, FARMER 305 S/LS/LSA, FARMER 306 S/LS/LSA, FARMER 307 S/LS/LSA, FARMER 308 S/LS/LSA, FARMER 309 S/LS/LSA, FARMER 310 LS/LSA	F178200090020	
51849	Esterno/Outer		240S, 250GT, 250SA, 250VA, 255GT, 275GT, 275GT/GTF/GTH, 275VA, 280PA, 345GT, 345GTM, 360GT, 360GTF, 360GTH, FARMER 240 S, FARMER 250 S/SA/V/VA, FARMER 260 S/SA/V/VA, FARMER 270 V/VA, FARMER 275 S/SA/V/VA, FARMER 280 S/SA/V/VA/P/PA, TS 80 ALLRAD	C13114/4, F100001160243, X810270073	
51850	Esterno/Outer		303 bis, 307LSA, 307, 308, 308LSA 178/01, 308LSA FWA 178/26, 309, 309LSA, 365GTA, 380GHA, 380GT, 380GTA	F178820090010	
53215	Interno/Inner		11S, 12S, 600LSA, 610LS 01/78-09/84, 610LSA, 611LS/LSA 01/76-12/93, 611LSA, 611SA/SL 01/72-12/76, 612LS/LSA 01/76-12/93, 612LSA, 612S/SA/SL 04/72-09/76, 614LS/LSA 01/76-12/93, 614LSA, 614S/SA 01/72-12/76, 614SL 01/72-12/76, 615LS/LSA 01/76-12/93, 615LSA, 615S/SL 01/72-09/76, FAVORIT 600LS, FAVORIT 610 LS/SA/SL, FAVORIT 611 LS/LSA/SA/SL, FAVORIT 612 LS/LSA/SL, FAVORIT 614 LS/LSA/SL, FAVORIT 615 LS/LSA/S/SL	F184230090100	
53216	Esterno/Outer		11S, 12S, 600LSA, 610LSA, 611LSA, 612LSA, 614LSA, 615LSA, 626LSA, 811SL	F184230090050, F291200090100	
53975	Interno/Inner		10S, 310, 310LS/LSA 01/84-08/93, 310LSA, 311, 311LAA 01/84-08/93, 311LSA, 312, 312LSA, 312LSA 01/87-08/93, 390GTA, 395GHA, 395GTA, 610S 01/72-12/76, 611S/SA 01/72-12/76, 612S/SA/SL 04/72-12/93, 614SL 01/72-12/76, FARMER 310LS/LSA, FARMER 311LSA, FARMER 312LSA, FAVORIT 610S, FAVORIT 611S/SA, FAVORIT 612S/SA/SL, FAVORIT 614S/SL/LS, FAVORIT 615S/SL/LS	F182200090010	
53976	Esterno/Outer		200 K/S/SA/V, 201S/SA, 203K/VK, 203P/PII/PA/PB/PE, 203V/VII/VA, 204P, 204P/PA/V/VA, 205P/PA/V/VA, 260P/PA/V/VA, 270P/PA/V/VA, 280P/PA, FARMER 200 K/V, FARMER 203 K/VK, FARMER 203 P/PII/PA/PB/PE, FARMER 203 V/VII/VA, FARMER 204 P/PA/V/VA, FARMER 205 P/PA/V/VA, FARMER 240, FARMER 260 P/PA/V/VA, FARMER 270 P/PA/V/VA, FARMER 280 P/PA	F135203092010	







Art./Ref.	Note/Notes	Brand	Applicazione/Application	Rif. Orig./Orig. Ref.	Immagine/Image
53977	Esterno/Outer	FENDT	102S, 103S, 104S, 105LSA, 105S, 106LSA, 106S, 108LSA, 108S	F278201090020	
59847	Interno/Inner		F345GT/GTM, F360GT/GTF/GTH	F205200091010, F345200090010	
35107	Esterno/Outer	FIAT		89835747	
02717	Esterno/Outer		446, 465, 465C/VF, 466, 565, 565C, 570 >09/80, 665 MONTAGNA, 665C, 665C >01/82, 666, 666 >01/82, 670, 670 FRUTTETO, 765, 765C, 766, 766 >01/82, 775C, 980DT, SERIE 46 55.46, SERIE 46 55.46DT, SERIE 46 65.46, SERIE 65 45.65, SERIE 65 55.65, SERIE 65 55.65 MONTAGNA, SERIE 65 55.65 VIGNETO, SERIE 65 60.65, SERIE 65 60.65 VIGNETO, SERIE 65 70.65, SERIE 65 70.65 MONTAGNA, SERIE 65 80.65, SERIE 66 45.66, SERIE 66 45.66DT VIGNETO, SERIE 66 45.66S, SERIE 66 55.66, SERIE 66 55.66DT, SERIE 66 55.66LP, SERIE 66 60.66DT, SERIE 66 60.66LP, SERIE 66 60.66VF, SERIE 66 65.66, SERIE 66 70.66, SERIE 66 70.66DT, SERIE 66 80.66, SERIE 66 80.66F, SERIE 66 80.66LB, SERIE 75 55.75, SERIE 75 60.75, SERIE 75 70.75, SERIE 75 80.75, SERIE 76 55.76 >01/85, SERIE 76 60.76 >01/85, SERIE 76 70.76/LP_F, SERIE 76 80.76, SERIE 76 80.76F, SERIE 76 80.76DT, SERIE 86 62.86/F, SERIE 86 72.86/LP_F, SERIE 86 82.86/LP_F, SERIE 88 55.88, SERIE 88 60.88, SERIE 88 70.88, SERIE 88 80.88, SERIE 90 55.90, SERIE 90 55.90DT, SERIE 90 60.90, SERIE 90 60.90DT	1909139	
02724	Interno/Inner		465C, 465C/V/F, 565C, 765C, SERIE 65 80.65C, SERIE 65 55.65C, SERIE 65 60.65C, SERIE 65 70.65C, SERIE 66 65.66, SERIE 66 70.66/LP-F, SERIE 66 50.66, SERIE 66 60.66, SERIE 66 60.66/LP, SERIE 66 80.66, SERIE 66 80.66/F, SERIE 66 55.66, SERIE 66 70.66, SERIE 66 45.66, SERIE 66 55.66/LP, SERIE 75 55.75C, SERIE 75 60.75C, SERIE 75 70.75C, SERIE 75 80.75C, SERIE 76 60.76/F, SERIE 76 70.76/LP-VF, SERIE 76 80.76/F, SERIE 86 72.86/LP-F, SERIE 86 82.86/LP-F, SERIE 86 62.86/F, SERIE 88 55.88, SERIE 88 60.88, SERIE 88 70.88, SERIE 88 80.88, SERIE 90 55.90, SERIE 90 60.90	1909138	
08284	Interno/Inner		1355C	73067508	
10486	Esterno/Outer		SERIE 55 160.55.00, SERIE 90 115.90, SERIE 90 160.90, SERIE 90 140.90, SERIE 90 180.90, SERIE 90 130.90	1930174, 9960550	
10487	Interno/Inner		1180DT, 1380DT, SERIE 55 160.55.00, SERIE 90 115.90, SERIE 90 160.90, SERIE 90 140.90, SERIE 90 180.90, SERIE 90 130.90	1909135, 1930175, 9957888, 9960551	
10493			455, 505, 50C OM, 555, 605, 655, 655C, 805, SERIE 65 55.65, SERIE 65 60.65, SERIE 75 55.75, SERIE 75 60.75	4963663, 596922	
12959			465, 565, 765, 855, SERIE 55 85.55C, SERIE 65 80.65C, SERIE 65 60.65, SERIE 65 70.65, SERIE 66 65.66, SERIE 66 50.66, SERIE 66 60.66, SERIE 66 80.66, SERIE 66 55.66, SERIE 66 70.66, SERIE 66 45.66, SERIE 88 55.88, SERIE 88 60.88, SERIE 88 70.88, SERIE 88 80.88, SERIE 90 70.90, SERIE 90 55.90, SERIE 90 60.90, SERIE 90 65.90, SERIE 90 80.90	4987759, 8322103	
14886	Esterno/Outer		SERIE 66 65.66, SERIE 66 50.66, SERIE 66 56.66S, SERIE 66 80.66, SERIE 66 55.66, SERIE 66 60.66, SERIE 66 70.66, SERIE 66 45.66, SERIE 85 55.85, SERIE 85 60.85, SERIE 86 72.86/LP-F, SERIE 86 82.86/LP-F, SERIE 86 62.86/F, SERIE 93 72.93, SERIE 93 60.93, SERIE 93 65.93, SERIE 93 82.93, SERIE 94 60.94, SERIE 94 82.94, SERIE 94 65.94, SERIE 94 72.94	1930587, 47128154, 47135972	

Art./Ref.	Note/Notes	Brand	Applicazione/Application	Rif. Orig./Orig. Ref.	Immagine/Image
14887	Interno/Inner	FIAT	SERIE 66 50.66, SERIE 66 56.66S, SERIE 66 65.66, SERIE 66 80.66, SERIE 66 55.66, SERIE 66 60.66, SERIE 66 70.66, SERIE 66 45.66, SERIE 85 55.85, SERIE 85 60.85, SERIE 86 72.86/LP-F, SERIE 86 82.86/LP-F, SERIE 86 62.86/F, SERIE 93 72.93, SERIE 93 60.93, SERIE 93 65.93, SERIE 93 82.93, SERIE 94 60.94, SERIE 94 82.94, SERIE 94 65.94, SERIE 94 72.94	1930588, 47135975	
14888	Interno/Inner		S-WINNER F140, S-WINNER F130	1930790, 1930795, 1930897, 79114560	
14889	Esterno/Outer		S-WINNER F140, S-WINNER F130	1930603, 1930826, 71415282	
15021	Interno/Inner		400, 420, 805	1909114, 4958602	
15022	Esterno/Outer		400, 420, 805	1909111, 4958601	
15145	Esterno/Outer		SERIE 60 35.60, SERIE 60 35.60S, SERIE 65 80.65, SERIE 65 60.65, SERIE 65 70.65, SERIE 66 65.66, SERIE 66 45.66, SERIE 66 45.66DT, SERIE 66 60.66, SERIE 66 80.66, SERIE 66 80.66DT, SERIE 66 50.66, SERIE 66 50.66DT, SERIE 66 55.66, SERIE 66 70.66, SERIE 66 70.66DT, SERIE 76 80.76, SERIE 76 80.76DT, SERIE 88 55.88, SERIE 88 60.88, SERIE 88 70.88, SERIE 88 80.88, SERIE 93 72.93, SERIE 93 88.93, SERIE 93 60.93, SERIE 93 65.93, SERIE 93 82.93, SERIE 94 60.94, SERIE 94 82.94, SERIE 94 65.94, SERIE 94 72.94	1930536	
15146	Interno/Inner		SERIE 65 80.65, SERIE 65 60.65, SERIE 65 70.65, SERIE 66 65.66, SERIE 66 60.66, SERIE 66 80.66, SERIE 66 55.66, SERIE 66 70.66, SERIE 88 55.88, SERIE 88 60.88, SERIE 88 70.88, SERIE 88 80.88, SERIE 93 72.93, SERIE 93 88.93, SERIE 93 60.93, SERIE 93 65.93, SERIE 93 82.93, SERIE 94 60.94, SERIE 94 82.94, SERIE 94 65.94, SERIE 94 72.94, SERIE TD TD60D, SERIE TD TD65D, SERIE TD TD75D, SERIE TD TD85D, SERIE TK TK100A, SERIE TK TK76, SERIE TK TK80A, SERIE TK TK80MA, SERIE TK TK85, SERIE TK TK85M, SERIE TL TL70A, SERIE TL TL80A	1930537	
15147	L. 353 mm. Esterno/L. 353 mm. Outer		SERIE 90 110.90, SERIE 90 100.90, SERIE 90 85.90, SERIE 93 88.93, SERIE 94 88.94, SERIE WINNER F100, SERIE WINNER F110, SERIE WINNER F120, SERIE WINNER F115	1930589, 47128157	
15148	Interno/Inner		SERIE 90 110.90, SERIE 90 100.90, SERIE 90 85.90, SERIE 93 88.93, SERIE 94 88.94, SERIE WINNER F100, SERIE WINNER F110, SERIE WINNER F120, SERIE WINNER F115	1930590, 47128156	
15149	Esterno/Outer		SERIE 66 35.66	1930591	
15150	Interno/Inner	SERIE 66 35.66	1930592		

Art./Ref.	Note/Notes	Brand	Applicazione/Application	Rif. Orig./Orig. Ref.	Immagine/Image
15183	Esterno/Outer	FIAT	1355C, 16, 18HD/LC, 18R, 7, 7B, 9, 9 LPG, SERIE 1300	1909957, 70257024, 73067507, 73119795, 79011386, 79083212, 8014390, 87704240, 9927604	
15185	Interno/Inner		SERIE 66 55.66/VF, SERIE 76 45.76/V, SERIE 86 70.86/V, SERIE 86 50.86/V, SERIE 86 55.86/VF, SERIE 86 60.86/VF	1930442	
15186	Esterno/Outer		SERIE 66 55.66/VF, SERIE 76 45.76/V, SERIE 86 70.86/V, SERIE 86 50.86/V, SERIE 86 55.86/VF, SERIE 86 60.86/VF	1930443	
15187	Autopulente. Interno/Self-cleaning. Inner		SERIE 75 55.75, SERIE 75 60.75, SERIE 75 70.75, SERIE 75 80.75, SERIE 85 72.85, SERIE 85 82.85, SERIE 85 62.85	1930730, 700053475, 79062700	
15193	Esterno/Outer		SERIE 75 55.75, SERIE 75 60.75, SERIE 75 70.75, SERIE 75 80.75, SERIE 85 72.85, SERIE 85 82.85, SERIE 85 62.85	1930764, 79062702, 79072795	
17751	Esterno/Outer		TW 10 BSD 666, TW 5 BSD 666	81866927	
28221	L. 305mm. Interno/L. 305mm. Inner		100.90 - 100.90 DT, 110.90 - 110.90 DT, 1180DT, 1280, 1280DT, 1380DT, 1580DT, 1880DT, 55.90 - 55.90 DT, 580, 580DT, 60.90 - 60.90 DT, 65.90 - 65.90 DT, 680, 680DT, 70.90 - 70.90 DT, 70C, 70CI, 70R, 780, 780DT, 80.90 - 80.90 DT, 80CA, 80R, 85.90 - 85.90 DT, 855, 88.93 - 88.93 DT, 88.94 - 88.94 DT, 880, 880/S, 880DT, 90.90 - 90.90 DT, 905C, 955, 980, 980DT, 995C, F100 - F100 DT, F110 - F110 DT, F115 - F115 DT, F120 - F120 DT	1909117, 1930825, 71406283	
28222	Esterno/Outer		SERIE 85 88.85	1930824, 1931027, 71405431, 71467925, 87342507	
28224	Esterno/Outer		SERIE 55 85.55, SERIE 55 95.55, SERIE 90 110.90, SERIE 90 100.90, SERIE 90 70.90, SERIE 90 85.90, SERIE 90 55.90, SERIE 90 60.90, SERIE 90 65.90, SERIE 90 90.90, SERIE 90 80.90	1930138, 9960540	
28225	Esterno/Outer		88.93 - 88.93 DT, 88.94 - 88.94 DT, F100 - F100 DT, F110 - F110 DT, F115 - F115 DT, F120 - F120 DT	1930605	
35106	Interno/Inner			89835746	
35099	Interno/Inner			80748274	
35100	Esterno/Outer			80753486	
35104	Interno/Inner			89811231	
28218	Esterno/Outer			1930783, 320651750	
15157R	Interno/Inner			1930900, 79114557	
28216	Prefiltro/Prefilter			5127309, 79049788	
15156R	Interno/Inner			1930598, 1930759, 4971959, 4972550, 8322161	
15158	Interno/Inner			1930901	
15116	Esterno/Outer			1930787, 320498750	
15192	Interno/Inner		1930760, 70197588		
15144	Interno/Inner		1909129		



Art./Ref.	Note/Notes	Brand	Applicazione/Application	Rif. Orig./Orig. Ref.	Immagine/Image
12959		FORD	3435 8035.06, 3935 8035.06, 4135 8035.06	8322103	
14886	Esterno/Outer		3435 8035.06, 3935, 3935 8035.06, 4030, 4135 8035.06, 4230, 4430, 4635 8035.06, 4835 8045.06, 5635 8045.06, 6635, 7635	1930587	
14887	Interno/Inner		3435 8035.06, 3935, 3935 8035.06, 4030, 4135 8035.06, 4230, 4430, 4635 8035.06, 4835 8045.06, 5635 8045.06, 6635, 7635	1930588	
15145	Esterno/Outer		4635, 4835, 5635	1930536, 87780710	
15146	Interno/Inner		4635, 4835, 5635	1930537	
15147	L. 353 mm. Esterno/L. 353 mm. Outer		4635, 4835, 5635, 6635, 7635	47128157	
15148	Interno/Inner		4635, 4835, 5635, 6635, 7635	1930590	
15183	Esterno/Outer		1164, 1454	5011316, 5011549	
15185	Interno/Inner		3830	1930442	

Art./Ref.	Note/Notes	Brand	Applicazione/Application	Rif. Orig./Orig. Ref.	Immagine/Image
15186	Esterno/Outer	FORD	3830	1930443	
17749	L. 380mm. Esterno/L. 380mm. Outer		2310 BSD 326, 2610>01.82 BSD 329, 2810 BSD 326, 2910 BSD 329, 3230 BSD 332, 3430 BSD 332, 3610>01.82 BSD 332, 3910 BSD 332, 3930 BSD 333, 4110>01.82 BSD 333H, 4130 BSD 333, 4610>01.82 BSD 333H, 4630 BSD 333H, 4830 BSD 442, 5030 BSD 442, 5110 BSD 444, 5600 10/80< BSD 444, 5600<09/80 BSD 442, 5610 BSD 444, 5700 10/80< BSD 444, 5700<09/80 BSD 442, 6600>09.80 BSD 444, 6710>09.80 BSD 444, 8500	83908365, 86908365, D6NN-9601-B	
17750	L. 336mm. Interno/L. 336mm. Inner		2310 BSD 326, 2610>01.82 BSD 329, 2810 BSD 326, 2910 BSD 329, 3230 BSD 332, 3430 BSD 332, 3610>01.82 BSD 332, 3910 BSD 332, 3930 BSD 333, 4110>01.82 BSD 333H, 4130 BSD 333, 4610>01.82 BSD 333H, 4630 BSD 333H, 4830 BSD 442, 5030 BSD 442, 5110 BSD 444, 5600 10/80< BSD 444, 5600<09/80 BSD 442, 5610 BSD 444, 5700 10/80< BSD 444, 5700<09/80 BSD 442, 6600>09.80 BSD 444, 6710>09.80 BSD 444	83908360, D6NN-9R- 500B	
28221	L. 305mm. Interno/L. 305mm. Inner		6635 - 7635	1930825	
28225	Esterno/Outer		6635 - 7635	1930605	
42174	Interno/Inner		8630 BSD 666T, 9700 BSD 666T, TW 15 BSD 666T, TW 20 BSD 666T	81866982, E6NN9R500FB	
42175			2100, 2110, 2120, 2150, 2310, 2503E, 2511E, 2513E, 3055, 3100, 3120, 3150, 3190, 3300, 3310, 3500, 3600, 4000, 4100, 4140, 4190, 420, 4200, 4400, 4410, 4610SU, 515, 531, 5320, 535, 5500, 620, 630, 640, 6610, 6710, 8630 BSD 666T, 9700 BSD 666T, DEXTRA 2000, MAJOR 16-6, MAJOR 4000, MAJOR 5000, SUPER DEXTRA 3000, TW 15 BSD 666T, TW 20 BSD 666T	81866999, D5NN9B618B, E6NN9B618BB	
42176	L.443mm. Interno/L.443mm. Inner		8730 BSD 666T, 8830 BSD 666TI, TW 25 BSD 666T, TW 30 BSD 666TI, TW 35 BSD 666TI	83913764, D8NN9R500AA	
42177	L.475mm. Esterno/L.475mm. Outer		8730 BSD 666T, 8830 BSD 666TI, TW 25 BSD 666T, TW 30 BSD 666TI, TW 35 BSD 666TI	83913766, D8NN9B618AA	
42178	L. 288 mm. Interno/L. 288 mm. Inner		5640 P.S. 4.4, 6640 P.S. 5.0, 66400 FRUTTETO, 77400 FRUTTETO, 7840 P.S. 6.6, 8160, 8240 P.S. 7.5, 8260, 8340 9/93< P.S. 7.5T, 8340<8/93 P.S. 7.5, 8360, 8560	82008601, E9NN 9R500AB	
42179	L. 323 mm. Esterno/L. 323 mm. Outer	5610, 5640 P.S. 4.4, 6610, 6640 P.S. 5.0, 6810, 7610, 7740 P.S. 5.0T, 7840 P.S. 6.6, 8160, 8240 P.S. 7.5, 8260, 8340 9/93< P.S. 7.5T, 8340<8/93 P.S. 7.5, 8360, 8560	82008600, 82027152, E9NN9B618BA		

Art./Ref.	Note/Notes	Brand	Applicazione/Application	Rif. Orig./Orig. Ref.	Immagine/Image
08283	Esterno/Outer	HURLIMANN	105XT, 307XE, 372 TURBO, 4105DT TURBO, 476, 476.4, 476F/X, 481XF, 488 TURBO, 491XF, 496, 5110, 5116 TURBO, 607XADT, 6115, 6115 T ELITE, 6136, 656XA, 656XAA/DT >01/99, 657XA >06/99, 658XA >06/99, 706XN >01/99, 707XN >01/99, 708XN >01/99, 70XS, 908XTDT, 910.4XT, 910.4XTDT, 910.6XT, 910.6XTDT, 95XT, 98XT	2.4249.310.4	
08284	Interno/Inner		6115 - 6115T, 656DT - 656XAT, H 307 XE, H 372, H 4105 DT, H 488 - H 496, H 5110 - H 5116, H 6136, HA 607 DT, HA 65 - XF 481 - XF 491, HA 656 - XA 658, XN 706 - 707 - 708, XS 70, XT 105, XT 908 - XT 908 DT, XT 909 DT, XT 910.4 - XT 910.4 DT, XT 910.6 - XT 910.6 DT, XT 95	2.4249.130.7	
02717	Esterno/Outer	JOHN DEERE	1020, 10200U/VU, 1030, 105, 111 PEANUT, 1120, 1130, 1520, 1530, 1630, 1630 UV/VU, 165, 1830, 2020, 2030, 2120, 2120 CDN, 2130, 2440, 299, 300B, 301, 301A, 302, 302A, 310, 330, 3300, 34, 400, 401, 401B, 401C, 44, 45, 482, 499, 5200, 5300, 55, 600, 600A, 6000, 6300U, 65, 700, 710, 734, 800, 820, 820VU, 830, 830M, 84, 880, 925, 930, 95, 95H	AT20728, C14179	
02724	Interno/Inner		6000	AN153119	
15148	Interno/Inner		5000, 5083E/EN, 5093E/EN, 5101E/EN, 5210, 5220, 5220H, 5225, 5303, 5310, 5310N, 5320, 5320N, 5325, 5325N, 5403, 5410, 5410N, 5415, 5415H/N, 5420, 5420N, 5425, 5425N, 5503, 5510, 5510N, 5520, 5520N, 5525, 5525N, 5603, 5605, 5615, 5625, 5625HC, 5705, 5715, 5715HC, 5725, 5725H/HC, 6403, CT332	AT171854, RT6005011112	
15147	L. 353 mm. Esterno/L. 353 mm. Outer		3100, 3200(X), 3210(X), 3300(X), 3310(X), 3400(X), 3410(X)	AT171853, RT6005011111	
15183	Esterno/Outer		1650, JD34, JD44, JD45	CH18287, CHAM64261, TH106445	
53216	Esterno/Outer		3650	AZ30757	

Art./Ref.	Note/Notes	Brand	Applicazione/Application	Rif. Orig./Orig. Ref.	Immagine/Image
53241	Interno/Inner	JOHN DEERE	6100, 6200, 6210, 6300, 6400	AL78224	
53975	Interno/Inner		1052, 1155, 1350, 1550, 1750, 1850, 2250, 2355, 2450, 2550, 2555, 2650, 2750, 2755, 2850, 2855N, 2950, 2955, 3050, 3055, 3155, 3255, 3350, 950, 952	AZ20623	
08283	Esterno/Outer	LANDINI	10000, 10000S, 12500, 13000, 14500, 9080, 9080 HC, 9880, 9880 HC, C10500	3310355M91	
08284	Interno/Inner		14500, 9080, 9080 HC, 9880, 9880 HC	1093683M92	
14886	Esterno/Outer		5860, 6060, 6860, 6880, 7860, 7880, 8860, 8880, ADVANTAGE CAB E FOOT STEP: 85, ADVANTAGE CAB E FOOT STEP:55, ADVANTAGE CAB E FOOT STEP:60, ADVANTAGE CAB E FOOT STEP:65, ADVANTAGE CAB E FOOT STEP:75, ALPINE:65, ALPINE:75, ALPINE:85, ATLAS:70, ATLAS:75, ATLAS:80, ATLAS:85, BLIZZARD: 75, BLIZZARD:50, BLIZZARD:60, BLIZZARD:65, BLIZZARD:85, GHIBLI :80, GHIBLI NEW TIER 2: 85, GLOBUS:50, GLOBUS:55, GLOBUS:60, GLOBUS:65, GLOBUS:70, GLOBUS:75, GLOBUS:80, POWER FARM:60, POWER FARM:75, POWER FARM:85, REX CAB E FOOT STEP :60, REX CAB E FOOT STEP :70, REX CAB E FOOT STEP :80, REX NEW TIER 2:60, REX NEW TIER 2:70, REX NEW TIER 2:75, REX NEW TIER 2:80, REX NEW TIER 2:85, SERIE 60 NEW:5860, SERIE 60 NEW:6860, SERIE 60 NEW:7860, SERIE 60 NEW:7860 HC, SERIE 60 NEW:8860, SERIE 60 NEW:8860 HC, TREKKER :C75, TREKKER :C85, TREKKER :CF55, TREKKER :CF60, TREKKER :CF65, TREKKER :CF70, TREKKER :CF75, TREKKER :CF85, TREKKER COMPACT CF60, TREKKER COMPACT CF70, TREKKER COMPACT TIER 2:CF60, TREKKER COMPACT TIER 2:CF70, TREKKER NEW :70C/F/L, TREKKER NEW :80C/F/L, TREKKER NEW TIER 2: 75, TREKKER NEW TIER 2: 85, VISION :80, VISION NEW TIER 2:85	3540046M1	
14887	Interno/Inner		5860, 6060, 6860, 6880, 7860, 7880, 8860, 8880, ADVANTAGE CAB E FOOT STEP: 85, ADVANTAGE CAB E FOOT STEP:55, ADVANTAGE CAB E FOOT STEP:60, ADVANTAGE CAB E FOOT STEP:65, ADVANTAGE CAB E FOOT STEP:75, ALPINE:65, ALPINE:75, ALPINE:85, ATLAS:70, ATLAS:75, ATLAS:80, ATLAS:85, BLIZZARD: 75, BLIZZARD:50, BLIZZARD:60, BLIZZARD:65, BLIZZARD:85, GHIBLI :80, GHIBLI NEW TIER 2: 85, GLOBUS:50, GLOBUS:55, GLOBUS:60, GLOBUS:65, GLOBUS:70, GLOBUS:75, GLOBUS:80, POWER FARM:60, POWER FARM:75, POWER FARM:85, REX CAB E FOOT STEP :60, REX CAB E FOOT STEP :70, REX CAB E FOOT STEP :80, REX NEW TIER 2:60, REX NEW TIER 2:70, REX NEW TIER 2:75, REX NEW TIER 2:80, REX NEW TIER 2:85, SERIE 60 NEW:5860, SERIE 60 NEW:6860, SERIE 60 NEW:7860, SERIE 60 NEW:8860, TREKKER :C75, TREKKER :C85, TREKKER :CF55, TREKKER :CF60, TREKKER :CF65, TREKKER :CF70, TREKKER :CF75, TREKKER :CF85, TREKKER COMPACT CF60, TREKKER COMPACT CF70, TREKKER COMPACT TIER 2:CF60, TREKKER COMPACT TIER 2:CF70, TREKKER NEW :70C/F/L, TREKKER NEW :80C/F/L, TREKKER NEW TIER 2: 75, TREKKER NEW TIER 2: 85, VISION :80, VISION NEW TIER 2:85	3540047M1	
14888	Interno/Inner		14500, LEGEND:130, LEGEND:145, LEGEND:165	1426450M91	
14889	Esterno/Outer		LEGEND:130, LEGEND:145, LEGEND:165	3540392M91	

Art./Ref.	Note/Notes	Brand	Applicazione/Application	Rif. Orig./Orig. Ref.	Immagine/Image
15147	L. 353 mm. Esterno/L. 353 mm. Outer	LANDINI	6070, 9060, ADVANTAGE :L95GT, ATLAS:100, ATLAS:90, BLIZZARD:95, GHIBLI :100, GHIBLI :90, GHIBLI NEW TIER 2:105, GHIBLI NEW TIER 2:85, GHIBLI NEW TIER 2:95, LEGEND N/G:115, MYTHOS NEW TIER 2:105, MYTHOS: 110, MYTHOS:100, MYTHOS:90, POWER FARM: 105, POWER FARM: 95, REX CAB E FOOT STEP:100, REX CAB E FOOT STEP:90, REX NEW TIER 2:105, REX NEW TIER 2:95, TREKKER :C95, TREKKER NEW TIER 2: 105, TREKKER NEW TIER 2: 95, TREKKER NEW: 100C, TREKKER NEW: 90C/F/L, VISION NEW TIER 2:105, VISION NEW TIER 2:95, VISION:100, VISION:90	3540051M1	
15148	Interno/Inner		9060, ADVANTAGE :L95GT, ATLAS:100, ATLAS:90, BLIZZARD:95, GHIBLI :100, GHIBLI :90, GHIBLI NEW TIER 2:105, GHIBLI NEW TIER 2:95, LEGEND N/G:115, MYTHOS NEW TIER 2:105, MYTHOS NEW TIER 2:115, MYTHOS: 110, MYTHOS:100, MYTHOS:90, POWER FARM: 105, POWER FARM: 95, REX CAB E FOOT STEP:100, REX CAB E FOOT STEP:90, REX NEW TIER 2:105, REX NEW TIER 2:95, TREKKER :C95, TREKKER NEW TIER 2: 105, TREKKER NEW TIER 2: 95, TREKKER NEW: 100C, TREKKER NEW: 90C/F/L, VISION NEW TIER 2:105, VISION NEW TIER 2:95, VISION:100, VISION:90	3540052M1	
15183	Esterno/Outer		10000, 10000S, 10000S2, 10000S4, 12000, 12500, 12500 DT, 12500 DT/R, 13000, 13000 DT, 13000 MKII4, 14500, C10500	1093683M91	
15187	Autopulente. Interno/Self-cleaning. Inner		6550, 6880, 7880, 8850, 8880, FRUTTETI 530 F/L/V:4530V, FRUTTETI 530 F/L/V:5530, FRUTTETI 530 F/L/V:6030, FRUTTETI 530 F/L/V:6530, FRUTTETI 530 F/L/V:7530, FRUTTETI 530 F/L/V:8530, FRUTTETI 560 F/L/V: 6060, FRUTTETI 560 F/L/V: 8560, FRUTTETI 560 F/L/V:5560, FRUTTETI 560 F/L/V:6560, FRUTTETI 560 F/L/V:7560, VIGNETI CAB E FOOT STEP: 65V, VIGNETI CAB E FOOT STEP: 75V, VIGNETI CAB E FOOT STEP:55V, VIGNETI CAB E FOOT STEP:60V, VIGNETI REX CAB TIER 2:75V, VIGNETI REX CAB TIER 2:85V, VIGNETI REX CAB: 80V, VIGNETI REX CAB:60V, VIGNETI REX CAB:65V, VIGNETI REX CAB:70V	3310357M1	
15190	Esterno/Outer		14500	1426451M91	
15193	Esterno/Outer		5500, 6500, 6550, 6880, 6880 VM, 7500, 7880, 7880 VM, 8500, 8850, 8880, 8880 HC-VM, FRUTTETI 530 F/L/V:5530, FRUTTETI 530 F/L/V:6030, FRUTTETI 530 F/L/V:6530, FRUTTETI 530 F/L/V:7530, FRUTTETI 530 F/L/V:8530, FRUTTETI 530 V:4530, FRUTTETI 560 F/L/V/GE: 6060, FRUTTETI 560 F/L/V/GE: 6560, FRUTTETI 560 F/L/V: 8560, FRUTTETI 560 F/L/V:5560, FRUTTETI 560 F/L/V:7560, FRUTTETI 560 V: 4560, GHIBLI NEW TIER 2: 85, TREKKER NEW 100C, VIGNETI CAB E FOOT STEP: 65V, VIGNETI CAB E FOOT STEP: 75V, VIGNETI CAB E FOOT STEP:55V, VIGNETI CAB E FOOT STEP:60V, VIGNETI REX CAB TIER 2:75V, VIGNETI REX CAB TIER 2:85V, VIGNETI REX CAB: 80V, VIGNETI REX CAB:60V, VIGNETI REX CAB:65V, VIGNETI REX CAB:70V	3310358M1	
40686	L.267mm. Esterno/L.267mm. Outer		6505, 7505	1807257M1	
70547	Interno/Inner		LEGEND: 105, LEGEND: 115	3540419M91	

**FILTRI ARIA ORIGINALI LANDINI**

FILTRE AIR ORIGINAL LANDINI  
 AIR FILTERS ORIGINAL LANDINI  
 LUFTFILTER ORIGINAL LANDINI  
 FILTROS AIRE ORIGINAL LANDINI

Art./Ref.	Brand	Rif. Orig./Orig. Ref.
LN3540046M1	LANDINI	3540046M1
LN3540047M1	LANDINI	3540047M1
LN3540051M1	LANDINI	3540051M1
LN3540052M1	LANDINI	3540052M1



**FILTRI ARIA ADATTABILI MASSEY FERGUSON**

FILTRE AIR ADAPTABLE MASSEY FERGUSON  
 AIR FILTERS ADAPTABLE MASSEY FERGUSON  
 LUFTFILTER PASSEND ZU MASSEY FERGUSON  
 FILTROS AIRE ADAPTABLE MASSEY FERGUSON

Art./Ref.	Note/Notes	Brand	Applicazione/Application	Rif. Orig./Orig. Ref.	Immagine/Image
<b>08283</b>	Esterno/Outer	<b>MASSEY FERGUSON</b>	3050 A4.236, 3060 A4.248, 3065 A4.236, 3070 A4.236, 3075 1004.4, 3075 A4.236, 3080 A6.354.4, 3085 1006.6, 3090 A6.354.4, 3095 1006.6, 3115 1006.6, 3120 1006.6T, 3120T 1006.6T, 6110 4.41, 6120 4.41, 6130 1004.4T, 6140 1004.4T, 6150 1004.4T, 6160 1006.6, 6160 1006.6T, 6170 1006.6, 6170 1006.6, 6180 1006.6T, 698T A4.236, 699 A6.354.4	1062501M91, 3310355M91	
<b>08284</b>	Interno/Inner		1100 A6.354.1, 1200 A6.354.1, 1250 A6.354.4, 3050 A4.236, 3060 A4.248, 3065 A4.236, 3070 A4.236, 3075 1004.4, 3075 A4.236, 3080 A6.354.4, 3085 1006.6, 3090 A6.354.4, 3095 1006.6, 3115 1006.6, 3120 1006.6T, 3120T 1006.6T, 6110 4.41, 6120 4.41, 6130 1004.4T, 6140 1004.4T, 6150 1004.4T, 6160 1006.6, 6160 1006.6T, 6170 1006.6, 6170 1006.6T, 6180 1006.6T, 698T A4.236, 699 A6.354.4	1093683M92	
<b>11277</b>			135 AD3.152, 230 AD3.152, 240 AD3.152, 250 AD3.152, 550 AD3.152	1886673M93, 883914M94	
<b>11280</b>			135 AD3.152, 230 AD3.152, 240 AD3.152, 250 AD3.152, 550 AD3.152	1886670M1	
<b>14888</b>	Interno/Inner		1134, 55C, 55C SUPER, 600C, D600C	1423747M91, 1426450M91	
<b>15147</b>	L. 353 mm. Esterno/L. 353 mm. Outer		5425, 5435, 5445, 5455, 5460, 6445, 6455, 6460, 6470	3540051M1	
<b>15148</b>	Interno/Inner		5425, 5435, 5445, 5455, 5460, 6445, 6455, 6460, 6470	3540052M1	
<b>15183</b>	Esterno/Outer		1014, 1114, 1200, 1250, 22, 24, 300, 3306, 3366, 3366AD, 33B, 33C, 33X, 400, 400C, 400D, 400DD, 400E, 44, 44B, 450, 450ELC, 450S, 750, 80, 850, 950D, D300B, D300DD, D400C, L450, RDT10000, RDT12500, SERIE 10, SERIE 100, SERIE 1000, W450D/DLS	1093682M91, 1093906M91, 1866048M92, 258541M91, 2708733M91, 3072893M1, 3311624M91, 3621282M1, 3638563M1, 726199M1, 727121M91	
<b>40667</b>			265 <221523 A4.248, 275 <221523 A4.248, 285 <387021 A4.248, 290 <387021 A4.248, 590 <2/85 A4.248, 690 <2/85 A4.248	3611132M1	

Art./Ref.	Note/Notes	Brand	Applicazione/Application	Rif. Orig./Orig. Ref.	Immagine/Image
40685	Interno/Inner	MASSEY FERGUSON	133 AD3.152, 135 AD3.152, 140 AD3.152, 145 AD3.152, 148 AD3.152, 150 AD3.152, 152 AD3.152, 155 AD4.203, 158 AD4.203, 165 A4.212, 165 AD4.203, 168 A4.236, 175 A4.236, 178 A4.248, 185 A4.248, 188 A4.248, 65 AD4.203, 765 AD4.203	1887575M91	
40686	L.267mm. Esterno/L.267mm. Outer		133 AD3.152, 135 AD3.152, 140 AD3.152, 145 AD3.152, 148 AD3.152, 150 AD3.152, 152 AD3.152, 155 AD4.203, 158 AD4.203, 165 A4.212, 165 AD4.203, 168 A4.236, 175 A4.236, 178 A4.248, 185 A4.248, 188 A4.248, 65 AD4.203, 765 AD4.203	1807257M1, 26510236, 880271M1, 880271M91	
40694	Interno/Inner		365 A4.236, 375 A4.236, 390 A4.248, 390T AT4.236, 398 AT4.236, 399 1006.6, 399 A6.354.4	3595501M1	
40695			365 A4.236	3595500M1	
40703			4225 1004.4, 4225 4.41, 4235 1004.4, 4235 4.41, 4240 4.41	3901463M1	
40704	L. 359 mm. Interno/L. 359 mm. Inner		4225 1004.4, 4225 4.41, 4235 1004.4, 4235 4.41, 4240 4.41, 4245 1004.4T, 4255 1004.4T, 4255 4.41, 4265 1006.6	3901465M1	
40705			4225 1004.4, 4225 4.41, 4235 1004.4, 4235 4.41, 4240 4.41	3901462M1	
40706	L. 345 mm. Esterno/L. 345 mm. Outer		4225 1004.4, 4225 4.41, 4235 1004.4, 4235 4.41, 4240 4.41, 4245 1004.4T, 4255 1004.4T, 4255 4.41, 4265 1006.6	3901464M1	
40709			4260 1006.6, 4270 1006.6, 5260 1006.6	3901478M1	
40710			4260 1006.6, 4270 1006.6	3901477M1	

**PREFILTRI E VASCHEE ADATTABILI MASSEY FERGUSON**

PREFILTRE ET COUVETTE ADAPTABLE MASSEY FERGUSON  
 PRE-CLEANER AND BOWL ADAPTABLE MASSEY FERGUSON  
 VORFILTER UND SCHALE PASSEND ZU MASSEY FERGUSON  
 CHARTUCHO Y CUBETA ADAPTABLE MASSEY FERGUSON

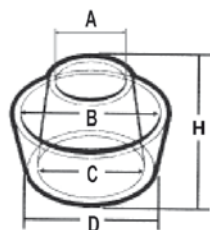

Art./Ref.	Descrizione/Description	A mm	B mm	C mm	D mm	H mm	Diametro foro mm/Hole diam. mm	Brand	Applicazione/Application	Rif. Orig./Orig. Ref.	Immagine/Image
40712	Prefiltro/ Pre-cleaner							MASSEY FERGUSON	230 AD3.152, 240 AD3.152, 250 AD3.152, 265 A4.236, 275 A4.236, 285 A4.248, 290 A4.248, 298 A4.318, 340 AD3.152, 342 AD3.152, 350 AD3.152, 352 AT3.152, 355 AT3.152, 360 AT3.152, 362 A4.236, 372 A4.236	1687562M1	
40713	Vaschetta/ Bowl	90	160	120	154	75	65	MASSEY FERGUSON	230 AD3.152, 240 AD3.152, 250 AD3.152, 265 A4.236, 275 A4.236, 285 A4.248, 290 A4.248, 298 A4.318, 340 AD3.152, 342 AD3.152, 350 AD3.152, 352 AT3.152, 355 AT3.152, 360 AT3.152, 362 A4.236, 372 A4.236	3473919M1	
40714	Prefiltro/ Pre-cleaner							MASSEY FERGUSON	3050 A4.236, 3060 A4.248, 3065 AT4.236, 3070 AT4.236, 3080 A6.354.4, 3090 A6.354.4, 365 A4.236, 375 A4.236, 390 A4.248, 390T AT4.236, 398 AT4.236, 399 A6.354.4, 698T AT4.236, 699 A6.354.4	1693129M1	
40715	Vaschetta/ Bowl	90	180	140	170	105	80	MASSEY FERGUSON	3050 A4.236, 3060 A4.248, 3065 AT4.236, 3070 AT4.236, 3080 A6.354.4, 3090 A6.354.4, 365 A4.236, 375 A4.236, 390 A4.248, 390T AT4.236, 398 AT4.236, 399 A6.354.4, 698T AT4.236, 699 A6.354.4	1508881M1	

**FILTRI ARIA ADATTABILI NEW HOLLAND**

FILRE AIR ADAPTABLE NEW HOLLAND  
 AIR FILTERS ADAPTABLE NEW HOLLAND  
 LUFTFILTER PASSEND ZU NEW HOLLAND  
 FILTROS AIRE ADAPTABLE NEW HOLLAND

Art./Ref.	Note/Notes	Brand	Applicazione/Application	Rif. Orig./Orig. Ref.	Immagine/Image
<b>02717</b>	Esterno/Outer	<b>NEW HOLLAND</b>	1048, 4030, 4230, 4430, 8066, TK 5565F, 5565F, 5565V, TK 5575F, 5575M, 5575V, TK 6065, 6065M, 6065V, TK 6075, 6075M, 6075V, TK 7065, 7065 M, TK 7075, 7075M, TK 8065, TK 8066 DT, TK 8075	1909139	
<b>02724</b>	Interno/Inner		TK 5565F, 5565M, 5565V, TK 5575F, 5575M, 5575V, TK 6065, 6065M, 6065V, TK 6075, 6075M, 6075V, TK 7065, 7065M, TK 7075, 7075M, TK 8065, TK 8066DT, TK 8075	1909138	
<b>12959</b>			4635 L60 8035.05, 4835 L65 8045.06, 5635 L75 8045.06, 6635 L85 8045.25, L60, L65, L75, TK 6065, 6065M, 6065V, TK 7065, 7065M, TK 8065, TK 8066DT, TK 8555, TL100, TL70, TL80, TL90	4987759, 8322103	
<b>14886</b>	Esterno/Outer		4635 L60 8035.05, 4835 L65 8045.06, 5635 L75 8045.06, L60, L65, L75, L85, L95, SERIE L L65, SERIE L L60, SERIE L L75, TD55D - TD60D - TD65D - TD70D, TD75D - TD80D - TD85D - TD90D, TD95D, TK5575F, TK5575M, TK5575V, TK5585F, TK5585M, TK5585V, TK6085F, TK6085V, TK65F, TK65V, TK75F, TK75M, TK75V, TK76, TK76M, TK85, TK85M, TK95M, TL70, TL80, TL90, TL100, TN55, TN65, TN70, TN75, TN55D, TN65D, TN70D, TN75D, TN55S, TN65S, TN70S, TN75S, TN55V, TN65V, TN75V, TN60A, TN70A, TN75A, TN60DA, TN70DA, TN75DA, TN60SA, TN70SA, TN75SA, TN65F, TN70F, TN75F, TN80F, TN65N, TN75N, TN90F, TN95F, TT65D	1930587, 47135972	
<b>14887</b>	Interno/Inner		4635 L60 8035.05, 4835 L65 8045.06, 5635 L75 8045.06, L60, L65, L75, L85, L95, SERIE L L65, SERIE L L60, SERIE L L75, TD55D - TD60D - TD65D - TD70D, TD75D - TD80D - TD85D - TD90D, TD95D, TK5575F, TK5575M, TK5575V, TK5585F, TK5585M, TK5585V, TK6085F, TK6085V, TK65F, TK65V, TK75F, TK75M, TK75V, TK76, TK76M, TK85, TK85M, TK95M, TL70, TL80, TL90, TL100, TN55, TN65, TN70, TN75, TN55D, TN65D, TN70D, TN75D, TN55S, TN65S, TN70S, TN75S, TN55V, TN65V, TN75V, TN60A, TN70A, TN75A, TN60DA, TN70DA, TN75DA, TN60SA, TN70SA, TN75SA, TN65F, TN70F, TN75F, TN80F, TN65N, TN75N, TN90F, TN95F, TT65D	1930588, 47135975	
<b>15145</b>	Esterno/Outer		4635 L60 8035.05, 4835 L65 8045.06, 5635 L75 8045.06, SERIE L L65, SERIE L L85, SERIE L L95, SERIE L L60, SERIE L L75, TD55D - TD60D - TD65D - TD70D, TD75D - TD80D - TD85D - TD90D, TD95D, TK60.65 - TK60.65 M, TK65F - TK65V, TK70.65 - TK70.65 M, TK70FA - TK70VA, TK75F - TK75FA, TK75M - TK75MA, TK75V - TK75VA, TK76 - TK76M, TK80.65, TK80A - TK80MA, TK85 - TK85M, TK90A - TK90MA, TK95M - TK100A, TL70 - TL80 - TL90 - TL100	1930536, 87780710	
<b>15146</b>	Interno/Inner		4635 L60 8035.05, 4835 L65 8045.06, 5635 L75 8045.06, SERIE L L65, SERIE L L60, SERIE L L75, TD55D - TD60D - TD65D - TD70D, TD75D - TD80D - TD85D - TD90D, TD95D, TK60.65 - TK60.65 M, TK65F - TK65V, TK70.65 - TK70.65 M, TK70FA - TK70VA, TK75F - TK75FA, TK75M - TK75MA, TK75V - TK75VA, TK76 - TK76M, TK80.65, TK80A - TK80MA, TK85 - TK85M, TK90A - TK90MA, TK95M - TK100A, TL70 - TL80 - TL90 - TL100	1930537	



Art./Ref.	Note/Notes	Brand	Applicazione/Application	Rif. Orig./Orig. Ref.	Immagine/Image
15147	L. 353 mm. Esterno/L. 353 mm. Outer		6635 L85 8045.25, 7635 L95 8045.25, L60, L65, L75, L95, SERIE L L95, SERIE L L85, SERIE TL TL100, SERIE TL TL100DT, SERIE TL TL70, SERIE TL TL70DT, SERIE TL TL75, SERIE TL TL80, SERIE TL TL90, SERIE TL TL90DT, TD55D, TD65D, TD75D, TD60D, TD70D, TD75D, TD80D, TD90D, TD95D, TD85D, TD95D, TK100-55, TL65, TL70, TL80, TL90, TL100	1930589, 47128157	
15148	Interno/Inner		6635 L85 8045.25, 7635 L95 8045.25, L60, L65, L75, L85, L95, SERIE L L95, SERIE L L85, SERIE LM LM1333, SERIE LM LM1440, SERIE TB TB100, SERIE TB TB110, SERIE TB TB120, SERIE TD TD60D PLUS, SERIE TD TD70D PLUS, SERIE TD TD80D PLUS, SERIE TD TD90D PLUS, SERIE TD TD95D, SERIE TD TD95D PLUS, SERIE TL TL100, SERIE TL TL100A, SERIE TL TL70A, SERIE TL TL90A, SERIE TN TN85A, SERIE TT TT55, SERIE TT TT75, TD55D, TD60D, TD65D, TD70D, TD75D, TD80D, TD85D, TD90D, TD95D, TK100-55, TL60, TL75, TL85, TL95, TL60E, TL75E, TL85E, TL95E, TL65, TL70, TL80, TL90, TL100	1930590, 47128156	
28221	L. 305mm. Interno/L. 305mm. Inner		6635 L85 8045.25, 7635 L95 8045.25, L85 - L95, SERIE L L95, SERIE L L85, SERIE TK TK100A, SERIE TK TK80A, SERIE TK TK80MA, SERIE TN TN75FA, SERIE TN TN85FA, SERIE TN TN90F, SERIE TN TN95DA, SERIE TN TN95F, SERIE TN TN95VA, TD60D - TD70D - TD75D, TD80D - TD90D - TD95D, TK100.55, TK100A, TK65F - TK65V, TK70FA - TK70VA, TK75F - TK75M - TK75V, TK75FA - TK75MA - TK75VA, TK76 - TK76M, TK80A - TK80MA, TK85 - TK85M, TK85.55 - TK95.5, TK88.85 M, TK90A - TK90MA, TK95M, TL100, TL60 - TL65 - TL70 - TL75, TL60E - TL75E - TL85E - TL95E, TL80 - TL85 - TL90 - TL95, TN65F - TN70F - TN75F, TN75FA - TN85FA - TN95FA, TN80F - TN90F - TN95F, TN95NA, TN95VA	1930825, 71406283, 87342481	
28225	Esterno/Outer		6635 L85 8045.25, 7635 L95 8045.25, L85 - L95, SERIE L L95, SERIE L L85, TD60D - TD70D - TD75D, TD80D - TD90D - TD95D, TL100, TL60 - TL65 - TL70 - TL75, TL60E - TL75E - TL85E - TL95E, TL80 - TL85 - TL90 - TL95	1930605	
42178	L. 288 mm. Interno/L. 288 mm. Inner		M100, M115, M135, SERIE M M115, SERIE M M150, SERIE M M100, SERIE TM TM115, SERIE TS TS100, SERIE TS TS110, SERIE TS TS90, TM115, TM125, TM135, TM150, TM165, TS110, TS115, TS120, TS80, TS90, TS100	82003739, 82008601	
42179	L. 323 mm. Esterno/L. 323 mm. Outer		M100, M115, M135, M160, SERIE M M100, SERIE M M115, SERIE M M150, SERIE TM TM115, TM115	82008600, 82027152	
35099	Interno/Inner			87682980	

**FILTRI ARIA ORIGINALI CNH**

FILTRE AIR ORIGINAL CNH  
 AIR FILTER ORIGINAL CNH  
 LUFTFILTER ORIGINAL CNH  
 FILTROS ORIGINAL CNH

Art./Ref.	Brand	Rif. Orig./Orig. Ref.
NH1909138	NEW HOLLAND	1909138
NH1909139		1909139
NH1930174		1930174
NH1930175		1930175
NH1930442		1930442
NH1930443		1930443
NH1930605		1930605
NH1930730		1930730, 47498744
NH1930764		1930764, 84375819
NH1930825		1930825
NH47135975		47135975, 86982523
NH5196842		5196842
NH87682993		1930589, 87682993
NH87682999		1930590, 87682999
NH87704249		47135972, 87704249
NH82027152		82027152
NH82008601		82008601
NH5128507R		5128507

**FILTRI ARIA ADATTABILI RENAULT**

FILTRE AIR ADAPTABLE RENAULT  
 AIR FILTERS ADAPTABLE RENAULT  
 LUFTFILTER PASSEND ZU RENAULT  
 FILTROS AIRE ADAPTABLE RENAULT

Art./Ref.	Note/Notes	Brand	Applicazione/Application	Rif. Orig./Orig. Ref.	Immagine/Image
51846	Interno/Inner	RENAULT	90 S/V/VE, R 42-70 F, R 42-70 V, R 490 S		
51849	Esterno/Outer		42-70 F/V, 490S, 90 S/V/VE		
53215	Interno/Inner		113.14TS/TX, 145.14TX, R1451-4 (S)		

Art./Ref.	Note/Notes	Brand	Applicazione/Application	Rif. Orig./Orig. Ref.	Immagine/Image
53975	Interno/Inner	RENAULT	70 (X), 70.12 SP, 70.14 SP, 75 (X), 85.12 LS, 851, 851-4, 95.12 TX, 95.14 TX, R 421 M, R 551 (S), R 651-4, R 851-4 (S)		
59847	Interno/Inner		42-70F/IV, 490S, 90S/V/VE, 50S/SV, 490, 44-70F, 90S VIGNE, 90S VERGER, 90S FRUITIER	7701025065	

**FILTRI ARIA ADATTABILI SAME**

FILRE AIR ADAPTABLE SAME  
 AIR FILTERS ADAPTABLE SAME  
 LUFTFILTER PASSEND ZU SAME  
 FILTROS AIRE ADAPTABLE SAME

Art./Ref.	Note/Notes	Brand	Applicazione/Application	Rif. Orig./Orig. Ref.	Immagine/Image
08283	Esterno/Outer	SAME	ANTARES 100, ARGON 70, ASTER 70, EXPLORER 70 C, EXPLORER 65 C, EXPLORER 75 C, EXPLORER 75 SPECIAL, EXPLORER 80 C, EXPLORER 90 C, EXPLORER 90 II SPECIAL, EXPLORER 90 SPECIAL, FRUTTETO 75 II, FRUTTETO 85 II, LASER 100, LASER 110, LASER 130, LASER 90, ROW CROP 90, SILVER 100.4, SILVER 100.6, SILVER 80, SILVER 90	0.009.4108.0, 2.4249.130.0, 2.4249.131.0, 2.4249.310.4	
08284	Interno/Inner		100 DT, 100.4 DT - 100.6 DT, 110 DT - 130 DT, 80 - 80 C - 80 DT, 90 - 95, ANTARES 100 - 110, BUFFALO 120 - 130, DORADO 85, DRAGO 100, EXPLORER 70 C, EXPLORER 75 - 80 - 90, EXPLORER 90 C, EXPLORER II 90 - 90 SP, JAGUAR 95 - 100, LASER 90 - 100 - 110 - 130	2.4249.130.7	
15183	Esterno/Outer		1056L, 1056P, BUFFALO 120 2RM, BUFFALO 130 4RM, BUFFALO 130 EXPORT, DRAGO 100, JAGUAR 95, JAGUAR 95 EXPORT, LASER 100, LASER 110, LASER 130, LEOPARD 90 TURBO, PANTHER 90, PANTHER 95, TIGER 100 2RM, TIGER SIX 105, TIGER SIX 105 EXPORT, TRIDENT 130 EXPORT	2.4249.130.1, 2.4249.130.8	
15185	Interno/Inner		ARGON 50, ARGON 60, ASTER 60, CENTAURO 70 EXPLORER, CENTAURO 70 SPECIAL, CENTURION 75 SPECIAL, EXPLORER 70 C, EXPLORER 55, EXPLORER 60, EXPLORER 60 SPECIAL, EXPLORER 65, EXPLORER 65 C, EXPLORER 65 SPECIAL, EXPLORER 70, EXPLORER 70 SPECIAL, EXPLORER 75 SPECIAL, EXPLORER II 60, EXPLORER II 60 SPECIAL, EXPLORER II 70, EXPLORER II 70 SPECIAL, EXPLORER II 70 SPECIAL B, FRUTTETO 60, FRUTTETO 60 II, FRUTTETO 75, MERCURY 85 SPECIAL, MINITAURUS 60 FRUTTETO, MINITAURUS 60 SYNCRO, ROW CROP 85, SOLAR 50, SOLAR 55 C, SOLAR 60, SOLAR 60 C	2.4249.340.2, 2.4249.390.2	
15186	Esterno/Outer		ARGON 50, ARGON 60, ASTER 60, CENTAURO 70 EXPLORER, CENTAURO 70 SPECIAL, CENTURION 75 SPECIAL, EXPLORER 70 C, EXPLORER 55, EXPLORER 60, EXPLORER 60 SPECIAL, EXPLORER 65, EXPLORER 65 C, EXPLORER 65 SPECIAL, EXPLORER 70, EXPLORER 70 SPECIAL, EXPLORER 75 SPECIAL, EXPLORER II 60, EXPLORER II 60 SPECIAL, EXPLORER II 70, EXPLORER II 70 SPECIAL, EXPLORER II 70 SPECIAL B, FRUTTETO 60, FRUTTETO 60 II, FRUTTETO 75, MERCURY 85 SPECIAL, MINITAURUS 60 FRUTTETO, MINITAURUS 60 SYNCRO, ROW CROP 85, SOLAR 50, SOLAR 55 C, SOLAR 60, SOLAR 60 C	2.4249.340.1	
28226	Interno/Inner		AURORA 45, CENTURION 75, DELFINO 35, DELFINO 35 FRUTTETO, LEOPARD 85, LEOPARD 85 EXPLORER, PANTHER 88, RANGER 45, RANGER 45 FRUTTETO	2.4249.060.1, 2.4249.060.8, 2.4249.500.2, 2.4249.510.1	
28218	Esterno/Outer			009.4876.0	

**FILTRI ARIA ORIGINALI SAME DEUTZ FAHR**

FILTRE AIR ORIGINAL SAME DEUTZ FAHR  
 AIR FILTERS ORIGINAL SAME DEUTZ FAHR  
 LUFTFILTER ORIGINAL SAME DEUTZ FAHR  
 FILTROS AIRE ORIGINAL SAME DEUTZ FAHR

Art./Ref.	Brand	Rif. Orig./Orig. Ref.
<b>V2.4249.130.7</b>	<b>SAME</b>	2.4249.130.7
<b>V2.4249.131.0</b>		2.4249.131.0
<b>V2.4249.190.1</b>		2.4249.190.1
<b>V2.4249.340.1</b>		2.4249.340.1
<b>V2.4249.340.2</b>		2.4249.340.2
<b>V2.4249.040.0</b>		2.4249.040.0
<b>V0.010.2183.0</b>		0.010.2183.0
<b>V2.4239.110.0</b>		2.4239.110.0

**FILTRI ARIA ADATTABILI STEYR**

FILTRE AIR ADAPTABLE STEYR  
 AIR FILTERS ADAPTABLE STEYR  
 LUFTFILTER PASSEND ZU STEYR  
 FILTROS AIRE ADAPTABLE STEYR



Art./Ref.	Note/Notes	Brand	Applicazione/Application	Rif. Orig./Orig. Ref.
<b>02724</b>	Interno/Inner	<b>STEYR</b>	CTV 130, CTV 150, CTV 170, CTV120	C1281
<b>08284</b>	Interno/Inner		CTV 130, CTV 150, CTV 170, CTV120	
<b>51846</b>	Interno/Inner		7070, 8055A, 8055S, 8060, 8070A, 942 WD308.48, 308., 948 WD308.48, 308.	31100190019
<b>51847</b>	Interno/Inner		M975 WD301, 8065 Turbo, 8075, 8080 Turbo, 8090, 946A WD301, 955A WD301, 970A WD301, M968A WD301	41185190007
<b>51849</b>	Esterno/Outer		7070, 8055A, 8055S, 8060, 8070A, 942 WD308.48, 308., 948 WD308.48, 308.	71201190021
<b>51850</b>	Esterno/Outer		M975 WD301, 8065 Turbo, 8075, 8080 Turbo, 8090, 946A WD301, 955A WD301, 970A WD301, M968A WD301	41185190010
<b>53215</b>	Interno/Interno/ Inner/Interno/ Interno		8130 Turbo, 8140, 8150, 8160 WD612.85, 612.89, 8160A WD612.85, 612, 8170A WD612.85, 612, 8180 Turbo WD612.89, 9105A, 9115, 9115A, 9125, 9125A, 9145A	61200190033
<b>53216</b>	Esterno/Esterno/ Outer/Typ : Luft / Aussen/Typo: Aire exterior		1090A, 1100, 1400, 8130 Turbo, 8140, 8150, 8160 WD612.85, 612.89, 8160A WD612.85, 612, 8170A WD612.85, 612, 8180 Turbo WD612.89, 9105A, 9115A, 9125A, 9145A	61200190038, 61200190701, C20325
<b>53975</b>	Interno/Interno/ Inner/Interno/ Interno		9084 WD401, 1200 WD612.40, 692, 792, 8100, 8100A, 8110, 8120, 8120A, 8130, 8130A, 8140, 8140A, 9078A WD401, 9083, 9083A WD401, 9086 WD401, 9086A WD401, 9094A WD401	61200190027

## TABELLA COMPARAZIONI FILTRI ARIA PER CODICE AMA - ARTICOLI ADATTABILI ALLE SEGUENTI MARCHE

TABLEU COMPARAISONS FILTRE AIR PAR CODE AMA

TABLE OF AIR FILTERS COMPARISONS PER AMA CODE

LUFTFILTER VERGLEICHSTABELLE NACH AMA-CODE

TABLA COMPARACIONES FILTRO AIRE PARA CODIGO AMA

Riferimento AMA	OEM	Riferimento FIAAM	Riferimento Tecnocar	Riferimento M+H	Riferimento Donaldson	UFI	Note
02717	1909139	FLI6489	A592	C14179	P18-1052	2792000	FRAM (CAK253), CARRARO, GOLDONI (6340316), KUBOTA (1500037101)
02724	1909138	FLI6612	A513	CF75/1	P12-3160	2701600	FRAM (CA2557SY)
08283	1930765	FLI6620	A581	C16340	P77-2550	-	-
08284	1093683M92	FLI6418	A582	CF922	P11-9410	2794900	PERKINS (26510228)
10486	1930174	FLI6794	-	-	P77-1527	2709400	FRAM (CA1544SY)
10487	1930175	-	-	-	P12-3828	-	-
10493	4963663	-	-	-	-	-	-
11277	883914M94	-	-	-	-	-	-
11280	1886670M1	-	-	-	-	-	-
12959	8322103	-	-	-	-	-	-
14886	1930587	FLI6905	A783	C14210/2	P77-2579	2742900	-
14887	1930588	-	-	-	P77-5300	2743000	-
15021	1909114	-	-	-	-	2775300	-
15022	1909111	FLI6834	A502	-	-	2775400	-
15145	1930536	-	-	-	P77-2565	-	-
15146	1930537	-	-	-	P77-0207	-	-
15147	1930589	FLI6926	A920	C17337	P77-2580	-	-
15148	1930590	FLI6927	-	CF990/2	P82-9333	-	-
15149	1930591	FLI6929	-	C11103	P77-2578	-	-
15150	1930592	-	-	CF620	P77-5298	-	-
15183	1909957	FLI6435	A580	C16302	P18-1059	2793200	-
15185	1930442	FLI6662	-	-	P77-0398	-	-
15186	1930443	FLI6663	-	-	P77-0397	-	-
15187	1930730	FLI6894	A589	-	P77-0181	-	-
15190	1930794	FLI6423	A732	C21431	P77-2545	-	-
15193	1930764	FLI6893	A583	-	P77-1549	-	-
17749	83908365	-	-	-	P52-6505	-	BALDWIN PA2587
17750	83908360	-	-	-	P52-6504	-	-
28221	1930825	-	-	-	P77-5457	-	FLEETGUARD AF25978
28222	1930824	-	-	-	P77-2553	-	BALDWIN PA3852FN
28224	1930138	FLI6858	-	-	P77-2535	-	-
28225	1930605	-	-	-	P77-8702	-	FLEETGUARD AF25342
28226	1169024	FLI6412	A572	C14190	P11-9135	2796900	DONALDSON EAF5215
40667	3611132M1	-	-	-	-	-	-
40685	1887575M91	FLI6410	A568	-	P12-0949	-	-
40686	1807257M1	FLI6200	A584	C12114	P13-6390	2776400	-
40694	3595501M1	-	A578, A581	CF961	P77-0735	-	-
40703	3901463M1	-	-	CF200	P78-0024	-	-
40704	3901465M1	-	-	CF300	P78-0030	-	LINDNER (CF300)
40705	3901462M1	-	-	CF14200	P77-8984	-	LINDNER (C14200)
40706	3901464M1	-	-	C15300	P77-8989	-	LINDNER (C15300)
40709	3901478M1	-	-	CF500	P78-0036	2750700	-
40710	3901477M1	-	-	C20500	P77-8994	2750600	-
40712	1687562M1	-	-	-	-	H001251	-
40713	3473919M1	-	-	-	-	-	-
40714	1693129M1	-	-	-	H001249	-	-
40715	1508881M1	-	-	-	P020227	-	-
42174	81866982	-	-	-	P52-6407	-	-
42175	E6NN9B618BB	-	-	-	P60-7357	-	-
42176	83913764	-	-	-	P12-4046	-	-
42177	83913766	-	-	-	P18-2070	-	-

Riferimento AMA	OEM	Riferimento FIAAM	Riferimento Tecnocar	Riferimento M+H	Riferimento Donaldson	UFI	Note
42178	82008601	-	-	-	P60-7343	-	-
42179	82027152, 82011402"	-	-	-	P78-8888, P60-7351	-	-
42200	81823388	-	-	-	H001250	-	-
51846	3148080R1	FLI6866	-	CF600	P77-7523	-	-
51847	3147878R1	FLI6799	-	CF700	P77-7524	-	-
51849	3142497R1	-	A727	-	P11-4637	-	-
51850	3146576R1	FLI6459	A494	C15260	P18-1089	2782800	-
53215	AZ30758	FLI6801	A493	CF1000	P77-6695	-	VALMET, ZETOR
53216	AZ30757	FLI6416	A542	C20325/2	P77-1561	-	-
53238	4384103	FLI6438	A524	C17250	P77-1557	2797300	-
53239	4308636	FLI6863	-	CF811	P77-8131	-	-
53241	AL78224	-	-	C1342	P78-3501	-	-
53975	AZ20623	FLI6417	A590	C17225/3	P18-1088	2780400	VALMET
53976	4384102	FLI6304	-	C17160, C17134	P77-1594	2783700	-
53977	F278201090020	FLI6627	A492	C17201	P77-1593	-	-
59833	3563577	FLI6458	A560	C13114/4	P14-0131	2788100	-
59839	5000241796	FLI6416	A542	C20325/2	P77-1561	2780200	VALMET, ZETOR
59846	7701019018	FLI6800	A491	CF800	P77-6694	2705500	VALMET
59847	7701025065	FLI6866	-	CF600	P77-7523	2798200	-
70541	3540418M91	-	-	-	-	-	FBN AT2.01856
70547	3540419M91	-	-	-	-	-	FBN AT1.01834

# 1.7.5 Filtri Cabine

Cabin Filter



## Ricambi & accessori per macchine agricole

### SPARE PARTS & ACCESSORIES FOR AGRICULTURAL MACHINE

Tutti gli articoli della presente sezione, prodotti da AMA SPA e/o da terzi per conto di AMA, sono adattabili ("non originali") alle marche indicate ai sensi di quanto previsto dal REG. CE n. 1400/2002. I diritti sui marchi citati appartengono ai legittimi proprietari ed il loro uso ha l'esclusiva finalità di consentire all'utilizzatore la comparazione dei diversi prodotti. All items of this section, manufactured by AMA SPA and/or any third party on behalf of AMA, are adaptable ("non-original") to the brands listed under the provisions of the REG. CE n. 1400/2002. The rights on the trademarks belong to their respective owners and their usage is only aimed to allow the user to compare different products.

**FILTRI ARIA A PANNELLO ADATTABILI**

FILTRES AIR A PANNEAUX ADAPTABLE

PANEL'S AIR FILTERS ADAPTABLE

PLATTENLUFTFILTER PASSEND ZU

FILTRO AIRE A PANEL ADAPTABLE



Art./Ref.	A mm	B mm	H mm	Note/Notes	Brand	Applicazione/Application	Rif. Orig./Orig. Ref.
<b>08609</b>	130	400	61	ADATTABILE PANCLEAN AP3294/ADAPTABLE PANCLEAN AP3294	<b>CARRARO ANTONIO</b>	10400, 5400, 8400, 9400	45305574
<b>08623</b>	125	585	61	ADATTABILE PANCLEAN AP4424/ADAPTABLE PANCLEAN AP4424		TIGERTRAC 7700 TURBO	
<b>08625</b>	100	590	61	ADATTABILE PANCLEAN AP4497/ADAPTABLE PANCLEAN AP4497		7700 SUPERTIGRE, 7700 SUPERTRAC	45305049, 48013048
<b>08610</b>	355	400	61	ADATTABILE PANCLEAN AP5272/ADAPTABLE PANCLEAN AP5272			45305768
<b>08603</b>	100	320	56	ADATTABILE PANCLEAN AP3330/ADAPTABLE PANCLEAN AP3330	<b>BRIEDA</b>		1AC1333
<b>08625</b>	100	590	61	ADATTABILE PANCLEAN AP4497/ADAPTABLE PANCLEAN AP4497			1AC1329
<b>08623</b>	125	585	61	ADATTABILE PANCLEAN AP4424/ADAPTABLE PANCLEAN AP4424			1AC1355
<b>08629</b>	130	680	56	ADATTABILE PANCLEAN AP5460/ADAPTABLE PANCLEAN AP5460			1AC1306
<b>08609</b>	130	400	61	ADATTABILE PANCLEAN AP3294/ADAPTABLE PANCLEAN AP3294			1AC1304
<b>08624</b>	180	585	60	ADATTABILE PANCLEAN AP3316/ADAPTABLE PANCLEAN AP3316			1AC2305
<b>08625</b>	100	590	61	ADATTABILE PANCLEAN AP4497/ADAPTABLE PANCLEAN AP4497	<b>CASE</b>	2120,2130,2140,2150	401894A1, 450299A1
<b>08633</b>	190	711	56	ADATTABILE PANCLEAN AP3272/ADAPTABLE PANCLEAN AP3272		1060, 1075, 1160	1105394C1, 7021959, 926389C1, D2NN19N551A, D3NN19N551A, D5NN19N551A, E2NN19N551AA
<b>26512</b>	105	520	50	Adattabile panclean AW7821/Adaptable panclean AW7821		JX100U, JX1070U, JX1080U, JX1090U, JX1100U, JX55, JX65, JX75, JX85, JX95, JX70U, JX80U, JX90U	
<b>08624</b>	180	585	60	ADATTABILE PANCLEAN AP3316/ADAPTABLE PANCLEAN AP3316	<b>CLAAS</b>	NECTIS 227 F/VE/VL, NECTIS 237 VE/VL, NECTIS 257 F/VL, NECTIS 267 F/VL	
<b>08610</b>	355	400	61	ADATTABILE PANCLEAN AP5272/ADAPTABLE PANCLEAN AP5272	<b>FIAT</b>		79045228
<b>08612</b>	136	434	60	ADATTABILE PANCLEAN KP7736/ADAPTABLE PANCLEAN KP7736			5136393
<b>08615</b>	152	435	56	ADATTABILE PANCLEAN AP4594/ADAPTABLE PANCLEAN AP4594		1580, 1880	1930782, 5108728, 5109236
<b>08617</b>	147	457	59	ADATTABILE PANCLEAN KP7740/ADAPTABLE PANCLEAN KP7740		65.90, F100, F100 DT, F110 DT, F115 DT, F120 DT, F130, F140	5124932, 5160985
<b>08619</b>	125	465	56	ADATTABILE PANCLEAN AP4420/ADAPTABLE PANCLEAN AP4420			9960862
<b>08624</b>	180	585	60	ADATTABILE PANCLEAN AP3316/ADAPTABLE PANCLEAN AP3316			79079546
<b>08633</b>	190	711	56	ADATTABILE PANCLEAN AP3272/ADAPTABLE PANCLEAN AP3272			7021959, 70569300, 77021959
<b>14980</b>	178	435	60	ADATTABILE PANCLEAN AP4594G/ADAPTABLE PANCLEAN AP4594G		160.90, 180.90	5141540
<b>26512</b>	105	520	50	Adattabile panclean AW7821/Adaptable panclean AW7821		WINNER F130 HI.LO, WINNER F140 HI.LO	1868102, 47128151, 5181232, 5196842, 82014790
<b>28217</b>							1930782, 5109236
<b>08601</b>							79076385
<b>08633</b>	190	711	56	ADATTABILE PANCLEAN AP3272/ADAPTABLE PANCLEAN AP3272	<b>FORD</b>	6500, 6600, 6700, 6710, 7000, 8000, 8200, 8260, 8400, 9000, 9200, 9260, 9700	
<b>26512</b>	105	520	50	Adattabile panclean AW7821/Adaptable panclean AW7821		4635, 4835, 5635, 5640 SL/SLE, 6635, 6640, 6640 SL/SLE, 7635, 7840, 8160, 7740 SL/SLE, 8240, 8260, 8340, 8260, 8340 SL/SLE, 8360, 8560, 8770	82014790, 83994739



Art./Ref.	A mm	B mm	H mm	Note/Notes	Brand	Applicazione/Application	Rif. Orig./Orig. Ref.
<b>08624</b>	180	585	60	ADATTABILE PANCLEAN AP3316/ADAPTABILE PANCLEAN AP3316	<b>JOHN DEERE</b>	5210, 5310, 5410, 5510	ER047210
<b>08633</b>	190	711	56	ADATTABILE PANCLEAN AP3272/ADAPTABILE PANCLEAN AP3272		1020 >201000, 2350, 2355, 2550, 2750, 2755, 2950, 2955, 3020, 3055, 3150, 3155, 3255, 4000, 4030, 4040, 3830, 482, 482 S/N >237162, 4050, 4055, 4230, 4240, 4250, 4255, 4320, 4440, 4450, 4455, 4520, 4560, 4620, 4630, 4650, 4755, 4760, 4840, 4850, 4960, 484, 7740, 7745, 9900, 5020, 6030, 7020, 7520, 8430, 6000, 6500, 5730, 5820, 5830, 6622, 7722, 9900 COTTON PICKER, 8440, 8450, 8630, 8640, 8650, 8850, 9910, 9920, 9930, 9940, 9950, 9960, 9965	AN112705, RE11793
<b>08625</b>	100	590	61	ADATTABILE PANCLEAN AP4497/ADAPTABILE PANCLEAN AP4497	<b>KUBOTA</b>	M128XDT, M128XDT-C, ST 30	
<b>08633</b>	190	711	56	ADATTABILE PANCLEAN AP3272/ADAPTABILE PANCLEAN AP3272		7009001653	
<b>08629</b>	130	680	56	ADATTABILE PANCLEAN AP5460/ADAPTABILE PANCLEAN AP5460	<b>LANDINI</b>		3540200M1
<b>08631</b>	160	720	56	ADATTABILE PANCLEAN AP3273/ADAPTABILE PANCLEAN AP3273			3301748M91
<b>08624</b>	180	585	60	ADATTABILE PANCLEAN AP3316/ADAPTABILE PANCLEAN AP3316		10000(DA U50001), 13000 (DA U50001), 6580, 6650, 6880, 8850, 8880, 9080, 9880, ADVANTAGE 95GT, ADVANTAGE:55, ADVANTAGE:60, ADVANTAGE:65, ADVANTAGE:75, ADVANTAGE:85, ADVANTAGE:95, F/V ADVANTAGE 75, REX 60, REX 65, REX 70, REX 80, REX 90, REX VIGNETO 60, REX VIGNETO 65, REX VIGNETO 70, REX VIGNETO 80, VIGNETI CAB:55V, VIGNETI CAB:60V, VIGNETI CAB:65V, VIGNETI CAB:75V	3302666M92
<b>08629</b>	130	680	56	ADATTABILE PANCLEAN AP5460/ADAPTABILE PANCLEAN AP5460	<b>LAVERDA</b>	296 LCS, 3600, 3600R, 3850, 3890	300135837, 322820100
<b>08634</b>	125	740	60	ADATTABILE PANCLEAN AP6089/ADAPTABILE PANCLEAN AP6089		521, L521, L521 MCS, L624 MCS, L627	321750750
<b>08610</b>	355	400	61	ADATTABILE PANCLEAN AP5272/ADAPTABILE PANCLEAN AP5272	<b>LOCHMANN</b>		624014035
<b>08623</b>	125	585	61	ADATTABILE PANCLEAN AP4424/ADAPTABILE PANCLEAN AP4424			624015812
<b>08624</b>	180	585	60	ADATTABILE PANCLEAN AP3316/ADAPTABILE PANCLEAN AP3316			624015818
<b>08624</b>	180	585	60	ADATTABILE PANCLEAN AP3316/ADAPTABILE PANCLEAN AP3316	<b>MASSEY FERGUSON</b>	354, 364, 374, 675, 690, 36RS	3302666M91, 3302666M92
<b>08629</b>	130	680	56	ADATTABILE PANCLEAN AP5460/ADAPTABILE PANCLEAN AP5460		7270 BETA, 7270 AL BETA	
<b>08631</b>	160	720	56	ADATTABILE PANCLEAN AP3273/ADAPTABILE PANCLEAN AP3273			3301748M91
<b>08633</b>	190	711	56	ADATTABILE PANCLEAN AP3272/ADAPTABILE PANCLEAN AP3272		560	
<b>08624</b>	180	585	60	ADATTABILE PANCLEAN AP3316/ADAPTABILE PANCLEAN AP3316	<b>MCCORMICK</b>	F60, F70, F75, F80, F85F/GE/XL, F90, F95, F100, F105, V60, V65, V70, V75, V80, V85	
<b>08633</b>	190	711	56	ADATTABILE PANCLEAN AP3272/ADAPTABILE PANCLEAN AP3272			F84818
<b>08617</b>	147	457	59	ADATTABILE PANCLEAN KP7740/ADAPTABILE PANCLEAN KP7740	<b>NEW HOLLAND</b>	F100, F100DT, F110, F110DT, F115, F115DT, F120, F120DT, F130, F130DT, F140, F140DT	84268729
<b>08633</b>	190	711	56	ADATTABILE PANCLEAN AP3272/ADAPTABILE PANCLEAN AP3272		1075, 1495, 1500, 1900, 1400, 1500, 990, TR70, TR75, TR85, TR86, TR96	
<b>08634</b>	125	740	60	ADATTABILE PANCLEAN AP6089/ADAPTABILE PANCLEAN AP6089		SB 35/55, SB 36, SB 36 TIER2, SB54, SB 56, SB 56 TIER2, SB 58, SB 58 TIER2, SB 60, SB 60 TIER2, SB 62, SB 62 TIER2, SB 64, SB 64 TIER2, SB 65, SB 65 TIER2	321750750

Art./Ref.	A mm	B mm	H mm	Note/Notes	Brand	Applicazione/Application	Rif. Orig./Orig. Ref.
<b>26512</b>	105	520	50	Adattabile panclean AW7821/Adaptable panclean AW7821	<b>NEW HOLLAND</b>	SERIE L L65, SERIE L L60, SERIE L L95, SERIE L L75, SERIE L L85, SERIE M: M100, M115, SERIE M: M135, M135DT, M160, SERIE M: M160DT, SERIE TD: TD65D, TD75D, TD85D, SERIE TD: TD80PLUS, TD90D PLUS, SERIE TD: TD95D, TD95D PLUS, SERIE TL: TL100, TL100A, SERIE TL: TL100DT, SERIE TL: TL65, TL75, TL70DT, SERIE TL: TL70, TL70A, TL80, SERIE TL: TL80A, TL90, TL90A, SERIE TL: TL90DT, SERIE TM: TM115, TM120, TM125, SERIE TM: TM135, TM150, TM165, SERIE TS: TS100, TS110, TS115, SERIE TS: TS80, TS90	5196842, 81868102, 82012057
<b>08624</b>	180	585	60	ADATTABILE PANCLEAN AP3316/ADAPTABLE PANCLEAN AP3316	<b>RENAULT</b>	55-12 LB/V/F, 55-14 LB/V, 70-14 LB/V/F, 80-12 F, 80-14 LB/V/F, DIONIS 110, DIONIS 120, DIONIS 130, DIONIS 140, FRUCTUS 110, FRUCTUS 130, FRUCTUS 140, PALES 210, PALES 230, PALES 240	6005012555
<b>08625</b>	100	590	61	ADATTABILE PANCLEAN AP4497/ADAPTABLE PANCLEAN AP4497			
<b>08625</b>	100	590	61	ADATTABILE PANCLEAN AP4497/ADAPTABLE PANCLEAN AP4497	<b>SAME</b>	EXPLORER 55, EXPLORER 60, EXPLORER 60DT, EXPLORER 60F, EXPLORER 65, EXPLORER 70, EXPLORER 75 EXPORT, EXPLORER 85 EXPORT, EXPLORER ERGOMATIC, EXPLORER ERGOMATIC 75, EXPLORER ERGOMATIC 80, EXPLORER II TOP, GALAXY 170, LASER 130, LASER 150, LASER 150 TURBO, LASER 90, LASER 100, LASER 110	9244.330.3/10
<b>08629</b>	130	680	56	ADATTABILE PANCLEAN AP5460/ADAPTABLE PANCLEAN AP5460			9244.330.2, 9244.330.3
<b>08634</b>	125	740	60	ADATTABILE PANCLEAN AP6089/ADAPTABLE PANCLEAN AP6089			98706.512/01
<b>08616</b>	300	435	55				
<b>08620</b>	145	495	55				
<b>08621</b>	140	500	56	ADATTABILE PANCLEAN AP4463/ADAPTABLE PANCLEAN AP446			

**FILTRI A CARBONI ATTIVI ADATTABILI BRIEDA**

FILTRES CHARBON ACTIF ADAPTABLE BRIEDA

ACTIVE CARBON FILTER ADAPTABLE BRIEDA

AKTIVKOHLENFILTER PASSEND ZU BRIEDA

FILTRO CARBON ACTIVO ADAPTABLE BRIEDA

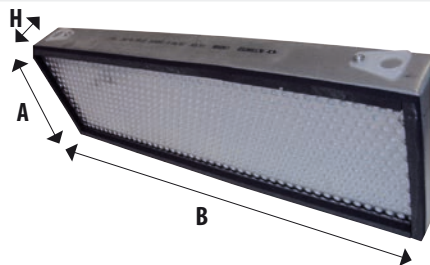

Art./Ref.	A mm	B mm	H mm	Note/Notes	Brand	Applicazione/Application	Rif. Orig./Orig. Ref.
<b>61322</b>	180	585	60	ADATTABILE PANCLEAN AX6254/ADAPTABLE PANCLEAN AX6254	<b>BRIEDA</b>	-	1AC2302
<b>75321</b>	230	700	61	ADATTABILE PANCLEAN AX5942/ADAPTABLE PANCLEAN AX5942		-	1AC1324
<b>75391</b>	213	292	55	ADATTABILE PANCLEAN AXH1021/ADAPTABLE PANCLEAN AXH1021	<b>FENDT</b>	-	H117.811.130.100, H210.812.140.200

Art./Ref.	A mm	B mm	H mm	Note/Notes	Brand	Applicazione/Application	Rif. Orig./Orig. Ref.
61320	70	650	60	ADATTABILE PANCLEAN AX8256 /ADAPTABLE PANCLEAN AX8256	FIAT		44911740, 47137324
75321	230	700	61	ADATTABILE PANCLEAN AX5942 /ADAPTABLE PANCLEAN AX5942		5164680	
75322	158	700	61	ADATTABILE PANCLEAN AX7909/ADAPTABLE PANCLEAN AX7909		5176033	
75323	104	520	49	ADATTABILE PANCLEAN AX7016/ADAPTABLE PANCLEAN AX7016		5097838	
61322	180	585	60	ADATTABILE PANCLEAN AX6254/ADAPTABLE PANCLENA AX6254	JOHN DEERE	5000,5210,5310,5410,5510,	ER047209
61322	180	585	60	ADATTABILE PANCLEAN AX6254/ADAPTABLE PANCLENA AX6254	LANDINI	10000(DA U50001), 13000 (DA U50001), 6880, 7880, 8880, 9080, 9880, ADVANTAGE:55, ADVANTAGE:60, ADVANTAGE:65, ADVANTAGE:75, ADVANTAGE:85, ADVANTAGE:95, BLIZZARD:50, BLIZZARD:60, BLIZZARD:65, BLIZZARD:75, BLIZZARD:85, BLIZZARD:95, FRUTTETI 560:5560, FRUTTETI 560:6060, FRUTTETI 560:6560, FRUTTETI 560:7560, FRUTTETI 560:8560, VIGNETI CAB:55V, VIGNETI CAB:60V, VIGNETI CAB:65V, VIGNETI CAB:75V	3311741M91
75329	95	570	55	ADATTABILE PANCLEAN AX8855/ADAPTABLE PANCLEAN AX8855		ALPINE, LANDPOWER, POWERFARM, POWERMASTER	3678352M91
75393	150	450	78	ADATTABILE PANCLEAN AX8595/ADAPTABLE PANCLEAN AX8595		GHIBLI NEW TIER 2:105, GHIBLI NEW TIER 2:85, GHIBLI NEW TIER 2:95, GHIBLI:100, GHIBLI:80, GHIBLI:90, LEGEND N/G-TDI:125-135-145-165, LEGEND N/G:115, LEGEND N/G:120, LEGEND N/G:130, LEGEND N/G:140, LEGEND N/G:160, LEGEND N/G:180, MYTHOS NEW TIER 2:105, MYTHOS:100, MYTHOS:110, MYTHOS:90, VISION NEW TIER 2:105, VISION NEW TIER 2:85, VISION NEW TIER 2:95, VISION:100, VISION:80, VISION:90	3651506M92
75394	170	435	60	ADATTABILE PANCLEAN AX9446/PANCLEAN ADAPTABLE AX9446		GLOBUS:50, GLOBUS:60, GLOBUS:70, LEGEND: FINO A K08305 105, LEGEND: FINO A K08305 115, LEGEND: FINO A K08305 130, LEGEND: FINO A K08305 145, LEGEND: FINO A K08305 165	3556390M92
61321	80	647	44	ADATTABILE PANCLEAN AX6205/ADAPTABLE PANCLEAN AX6205	MASSEY FERGUSON		3614022M91, 3614022M92
61322	180	585	60	ADATTABILE PANCLEAN AX6254/ADAPTABLE PANCLENA AX6254		354,36RS, 364,374	3311741M91, 3405118M1
61322	180	585	60	ADATTABILE PANCLEAN AX6254/ADAPTABLE PANCLENA AX6254	MCCORMICK	F100,F105,F60,F70,F75,F80,F85, F90,F95,V60,V65,V70,V75,V80, V85	
75329	95	570	55	ADATTABILE PANCLEAN AX8855/ADAPTABLE PANCLEAN AX8855		105,115,125,125 T3,130,135,T3, 145,145 T3,160,180,185,60A	
75393	150	450	78	ADATTABILE PANCLEAN AX8595/ADAPTABLE PANCLEAN AX8595		GM45, GM50, GM55, GX40	

Art./Ref.	A mm	B mm	H mm	Note/Notes	Brand	Applicazione/Application	Rif. Orig./Orig. Ref.
<b>61320</b>	70	650	60	ADATTABILE PANCLEAN AX8256/ADAPTABLE PANCLEAN AX8256	<b>NEW HOLLAND</b>	SERIE TN 55D,55S,55V,65D,65N, SERIE TN 65S,65V,70D,70F,70S, SERIE TN 75D,75F,75N,75S,75V, SERIE TN 80F,90F,95F	44911740, 47137324
<b>61323</b>	108	655	75	ADATTABILE PANCLEAN AX9642/PANCLEAN ADAPTABLE AX9642		TK4040, TK4050, TK4050M, TK4060, TN60VA, TN70NA, TN70VA, TN75NA,, TN75VA, TN85FA, TN95FA, TN95NA,	47135044
<b>75323</b>	104	520	49	ADAPTABLE PANCELAN AX7016/ADAPTABLE PANCELAN AX7016		7635 7740 7840 TL80 TS80 8160, 8260 8340 8360 8560 8770, T5050, T5060, T5070, TD55D, TL65, TD65D, TL75, T SL, DT 90, TM135, 150, 165, TD5040, T5050, TS100, TL-A, TL TS110, TM115, 120	5097838
<b>61322</b>	180	585	60	ADATTABILE PANCLEAN AX6254/ADAPTABLE PANCLANA AX6254	<b>RENAULT</b>	50-12LB/V, 55-12LB/V/F, 55-14LB/V, 70- 12V/F, 70-14LB/V/F, 80-12F, 80-14, DIONIS110, 120, 130, 140, FRUC- TUS110, 120, 130, 140,, PALES210	6000166226, 6005012634, 6005711904
<b>72555</b>	137	760	74	ADATTABILE PANCLEAN AX7228/PANCLEAN ADAPTABLE AX7228	<b>SAME LAMBORGHINI HURLIMANN</b>	EXPLORER 75, 80, 85, 85EXPORT, 90, FRUTTETO 60 II, 75 II, 85 II, HURLIMAN, HURLIMAN XA606, 607, 655, 656, SAME DORADO56, 66, 86,	0.009.9423.2
<b>75324</b>	150	670	73	ADATTABILE PANCLEAN AX6592/ADAPTABLE PANCLEAN AX6592		SAME DORADO55F, GOLDEN60, 60F/V, SAME DORADO75V, 90F, 90S, 90V, SAME GOLDEN65, DORADO70F, S, V, 75, SAME GOLDEN85	0.010.9535.2
<b>75325</b>	125	740	60	ADATTABILE PANCLEAN AX6872 /PANCLEAN ADAPTABLE AX6872			0.009.4303.0
<b>75326</b>	120	520	73	ADATTABILE PANCLEAN AX9294/ADAPTABLE PANCLEAN AX9294			0.012.0314.2
<b>75327</b>	105	617	53	ADATTABILE PANCLEAN AX7625/PANCLEAN ADAPTABLE AX7625			0.012.3260.2/30, 0.130.3242/20
<b>75392</b>	115	395	57	ADATTABILE PANCLEAN AX8732/ADAPTABLE PANCLEAN AX8732	<b>FENDT</b>		H816.810.140.070

# 1.7.6 Filtri piccoli motori

Little engine filters



**Ricambi & accessori per macchine agricole**

**SPARE PARTS & ACCESSORIES FOR AGRICULTURAL MACHINE**

Tutti gli articoli della presente sezione, prodotti da AMA SPA e/o da terzi per conto di AMA, sono adattabili ("non originali") alle marche indicate ai sensi di quanto previsto dal REG. CE n. 1400/2002. I diritti sui marchi citati appartengono ai legittimi proprietari ed il loro uso ha l'esclusiva finalità di consentire all'utilizzatore la comparazione dei diversi prodotti. All items of this section, manufactured by AMA SPA and/or any third party on behalf of AMA, are adaptable ("non-original") to the brands listed under the provisions of the REG. CE n. 1400/2002. The rights on the trademarks belong to their respective owners and their usage is only aimed to allow the user to compare different products.

**FILTRO PICCOLI MOTORI ADATTABILE**
*PETITS MOTEURS FILTRES ADAPTABLE ACME*
*SMALL ENGINES FILTERS ADAPTABLE ACME*
*KLEINMOTOREN-FILTER PASSEND ZU ACME*
*FILTROS DE MOTORES PEQUEÑOS ADAPTABLE ACME*

Art./Ref.	Note/Notes	Brand	Applicazione/Application	Rif. Orig./Orig. Ref.	Immagine/Image
<b>03912</b>	Nafta con piastra/ Fuel with plate	<b>ACME</b>	ACME	391.012	
<b>32011</b>	Aria /Air		A 180, A220, A220 B	359129300	
<b>01213</b>	Nafta/Fuel	<b>CARRARO</b>	CARRARINO SUPER 7LD 665	-	
<b>01213</b>	Nafta/Fuel/	<b>GOLDONI</b>	BASE 20 121D 475/2, SERIE 933 RS/DT LDA 914	-	
<b>02058</b>	Nafta /Fuel		COMPACT 614 - 602 - 604 - C 45, SERIE 993 RS/DT	-	
<b>02722</b>	Filtro a secco/Filter		926, 926 RS/DT.	-	
<b>02734</b>	Olio Avvitabile/Oil Screw-on		GOLDEN IDRO 1800 - 2000, SERIE 933 RS/DT	-	
<b>02746</b>	Olio Avvitabile/Oil Screw-on		COMPACT 614 - 602 - 604 - C45, TRANSCAR 55 - 60 MOTORE VM, TRATTRICE 1055	-	
<b>32143</b>	Olio/Oil		UNIVERSAL 236 SLANZI DVA 1550	-	

Art./Ref.	Note/Notes	Brand	Applicazione/Application	Rif. Orig./Orig. Ref.	Immagine/Image
37101	Nafta/Fuel	ISEKI	MT250-320-TS1910-3210-4270	141510201100	
37102	Nafta/Fuel		TX1500-2160-TX2160-TX2160HST	565004048790	
37104	Nafta/Fuel		4270 - 4370, 530, MT300	151310231100, 151310232900	
37105	Nafta/Fuel		F2400 - F2004B	151310231100	
37104	Nafta/Fuel	KOMATSU	15521, 43160, 55650, YM129100	-	
37099	Olio/Oil	KUBOTA	HH150 - 32430	15853-99170	
37100	Nafta/Fuel		L175, L185, L225, L245DT, L285 V1500A, L345 V1501DA	15221-43080, 15221-43170	
37101	Nafta/Fuel			10450-055710	
37103	Nafta/Fuel		B5100 Z5001A, B5200, B6100 D650A, B6200 D850-LA, B7100 D750A, B7100HST D750AH, B7200 D950-LA, B8200 D950A, B8200HST D950A	15231-43560, 15231-43563	
37104	Nafta/Fuel			15521-43160, 15567-8746-1	
37105	Nafta/Fuel			16271-43560	

Art./Ref.	Note/Notes	Brand	Applicazione/Application	Rif. Orig./Orig. Ref.	Immagine/Image
01212	Nafta/Fuel	<b>LOMBARDINI</b>	400 - 6LD400C - 400V, 6LD260 - 260C, 6LD325 - 325C, 6LD360 - 360C, 6LD360V, 6LD435, LDA500 - 503 - 520 - 522 - 530	2175.032	
01213	Nafta/Fuel		10LD400.2 - 10LD400.2/B, 10LD560.2 - 10LD360.2, 11LD535.3, 11LD625 - 11LD625.3, 12LD435.2 - 12LD435.2/B, 14LD475.2, 3LD 450 - 3LD 450S, 3LD 450 - 3LD 510, 3LD 510 - 3LD 510L, 3LD 535L, 4LD 640, 4LD 640 - 4LD 705, 4LD 820, 7LD600, 7LD665C - 7LD665F, 7LD740, 8LD600.2 - 8LD665.2 - 8LD740.2, 9LD560.2 - 9LD561.2, 9LD625 - 9LD625.3, LDA 100 - LDA 820, LDA 450 - LDA 510, LDA 710 - LDA 720 - LDA 740, LDA 904 - LDA 914 - LDA 940, LDA 96 - LDA 97	2175.009	
02042	Nafta/Fuel		LDW 1003, LDW 1204, LDW 1404, LDW 903	2175.143	
02058	Nafta/Fuel		5LD 2-3 cil 3/T, 11LD, 5LD 4 cil, 8LD, 9LD, CHD 1503, CHD 2004, CHD 2004/T, DVA 1030, DVA 1030/S, DVA 1200, LDW 1204, LDW 1404	2175.046	
02734	Olio Avvitabile /Oil Screw-on		10LD400.2 - 10LD400.2/B, 10LD560.2 - 10LD360.2, 11LD535.3, 11LD625 - 11LD625.3, 12LD435.2 - 12LD435.2/B, 14LD475.2, 400, 6LD260 - 260C, 6LD325 - 325C, 6LD360 - 360C, 6LD360V, 6LD400C - 400V, 6LD435, 8LD600.2 - 8LD665.2 - 8LD740.2, 9LD560.2 - 9LD561.2, 9LD625 - 9LD625.3, LDA500 - 503 - 520 - 522 - 530, LDA904 - LDA914 - LDA940	2175.040	
02736	Olio/Oil		6LD - 260, 6LD - 325, 6LD - 360, 6LD - 400, 6LD - 435, 6LD - 435/B1, LDA500 - 503 - 520 - 522 - 530	2175.019	
02746	Olio Avvitabile/Oil Screw-on		5LD 625.3 TURBO, 5LD 675.2, 5LD 675.3 - 5LD 675.4, 5LD 825.2 - 5LD 825.2L, 5LD 825.2 - 5LD 825.3L, 5LD 825.3 - 5LD 825.4, 5LD 930.3 - 5LD 930.4, LDA 672 - 673 - 674, LDA 832 - 833 - 834	2175.036	
03913	Nafta/Fuel		LGW 523, LGW 627	3730.106, 3730.121	
12711	Olio Avvitabile/Oil Screw-on		BASE 20 121D 475/2, FOCS SERIE LDW502 - 602 - 903	2175.107	
14425	Nafta/Fuel		12LD 435.2 - 12LD 435.2/B, 14LD 475.2, 3LD 450 - 3LD 450S, 3LD 450 - 3LD 510, 3LD 510 - 3LD 510L, 3LD 535L, 4LD 640, 4LD 640 - 4LD 705 - 4LD 820, 7LD 600, 7LD 665C - 7LD 665F, 7LD 740, 8LD 600.2 - 8LD 665.2, 8LD 740.2, FOCS SERIE LDW1204 - 1204T, FOCS SERIE LDW502 - 602 - 903, LD 96 - LD 97, LDA 100 - LDA 820, LDA 450 - LDA 510, LDA 904 - LDA 914 - LDA 940, LDA710 - LDA 720 - LDA 740	2175.045	



Art./Ref.	Note/Notes	Brand	Applicazione/Application	Rif. Orig./Orig. Ref.	Immagine/Image
14427	Olio/Oil	LOMBARDINI	LDW 1204, LDW 12047T, LDW 1404, LOMBARDINI	2175.131	
14428	Aria /Air		602, 903, LDW - 602, LDW - 702, LDW 1003, LDW 502, LDW 502 Citycar, LDW 903, SERIE FOCS LDW 502	2175.105, 2175.132, 2175.164	
14429	Aria /Air		1204T, LDW 1204, LDW 12047T, LDW 1404, SERIE FOCS LDW 1204	2175.165	
38001	Olio/Oil		15LD - 315, 15LD - 350	2175.155	
32011	Aria /Air		LGA 226, LGA 184, LGA 225, LGK 184	2175.156	
32143	Olio/Oil		3LD 450 - 3LD 450S, 3LD 450 - 3LD 510, 3LD 510 - 3LD 510L, 3LD 535L, 4LD 640, 4LD 640 - 4LD 705 - 4LD 820, LDA 100 - LDA 820, LDA 450 - LDA 510, LDA 96 - LDA 97	2175.028	
32145	Olio/Oil		5LD 625.3 TURBO, 5LD 675.2, 5LD 675.3 - 5LD 573.4, 5LD 825.2 - 5LD 825.2L, 5LD 825.2 - 5LD 825.3L, 5LD 825.4 - 5LD 824.4L, 5LD 930.3 - 5LD 930.4, LDA 672 - LDA 673 - LDA 674, LDA 832 - LDA 833 - LDA 834	2175.011	
37995	Nafta/Fuel		15LD - 315, 15LD - 350	3730.096	
37996	Aria /Air		15LD - 315, 15LD - 350	2175.176	
37997	Olio/Oil		CHD 1503, CHD 2004, CHD 2004/T, DVA 1030, DVA 1030/S, DVA 1200	2175.104	
37998	Olio/Oil		10LD400.2 - 10LD400.2/B, 10LD560.2 - 10LD360.2, 11LD535.3, 11LD625 - 11LD625.3, 12LD435.2 - 12LD435.2/B, 12LD475.2, 9LD560.2 - 9LD561.2, 9LD625 - 9LD625.3	2175.044	
37999	Olio/Oil		665 . 7LD665C - 7LD665F, 7LD600, 7LD740 - 7LD710, LDA720 - LDA740	2175.025	

Art./Ref.	Note/Notes	Brand	Applicazione/Application	Rif. Orig./Orig. Ref.	Immagine/Image
<b>38017</b>	Aria /Air	<b>LOMBARDINI</b>	6LD - 325, 6LD - 360, 6LD - 400, 6LD - 435, LDA500 - 503 - 520 - 522 - 530	2175.050	
<b>38018</b>	Aria /Air		10LD400.2 - 10LD400.2/B, 10LD560.2 - 10LD360.2, 11LD535.3, 11LD625 - 11LD625.3, 9LD560.2 - 9LD561.2, 9LD625 - 9LD625.3	2175.048	
<b>38019</b>	Cartuccia filtro combustibile / Fuel filter cartridge		15LD - 225	2175.182	
<b>01011</b>	Gasolio - Cartuccia/ Fuel - Cartridge	<b>PASQUALI</b>	(TUTTI I MODELLI / ALL MODELS)		
<b>02734</b>	Olio Avvitabile/ Oil Screw-on		PASQUALI		
<b>03912</b>	Nafta con piastra/ Fuel with plate		PASQUALI		
<b>02058</b>	Nafta/Fuel	<b>RUGGERINI</b>	11 LD 625, L27, L40, L54, LDA672, LDA673, LDA674, LDA832	175.19	
<b>02734</b>	Olio Avvitabile/Oil Screw-on		RD180 - RD181 - RD200 - RD201, RD210 - RD211 - RD218 - RD220, RD240 - RD270 - RD278	175.31	
<b>02746</b>	Olio Avvitabile/Oil Screw-on		CRD 1002/2 - CRD 951/2, CRDK 100/2, MW300 - 301 - 350 - MD 351, P 101/2 - P105/2, PK 105/2 - PM 105/2, RD 901/2 - RDK 901/2, RD 92/2, RD 952 - RDM 952, RDM 901/2 - RD 951/2	175.22	
<b>03912</b>	Nafta con piastra/Fuel with plate		RUGGERINI	391.12	

Art./Ref.	Note/Notes	Brand	Applicazione/Application	Rif. Orig./Orig. Ref.	Immagine/Image
11846	Nafta - cartuccia/Fuel - Cartridge	RUGGERINI	71, MC 70, MC 71 BRIO, MC70, MD 150, MD 170, MD 190, MICRO 51	175.32	
14425	Nafta/Fuel		CRD 95 - CRD 100 - CRD 951, P101 - RP 170 - RP 178, RD 101 - RD 105 - RD 850, RD 80 - RD 90 - RD 95 - RD 100, RD 900 - RD 901 - RD 920, RD 950, RP 850 - RP 900, RW 140 - RW 148	175.20	
32145	Olio/Oil		CRD 951, RD95/1	175.03	
02058	Nafta /Fuel	SLANZI	DVA 2000 - DVA 2200, DVA 2600 - DVA 2900	2175.084	
02722	Filtro a secco/Filter		DVA 1030, DVA 1030 MARINO, DVA 1030 S2, DVA 700, DVA 700 S, DVA 790, DVA 790S, DVA 920	40.84.05	
02734	Olio Avvitabile /Oil Screw-on		SERIE 105 - DS 2000	2175.068	
02746	Olio Avvitabile /Oil Screw-on		DVA 1550 S2, DVA 1750, DVA 2350	2175.071	
32143	Olio/Oil		DVA 1550	2175.090	
37101	Nafta /Fuel	YANMAR	104500-55710, 114050-55510, 114050-55510 104500-55710	-	
37104	Nafta /Fuel		129100-55650	-	
37105	Nafta /Fuel		114550-55700, 124550-55700	-	

**FILTRI ORIGINALI LOMBARDINI**

FILTRE ORIGINAL LOMBARDINI  
 FILTERS ORIGINAL LOMBARDINI  
 FILTER ORIGINAL LOMBARDINI  
 FILTROS ORIGINAL LOMBARDINI

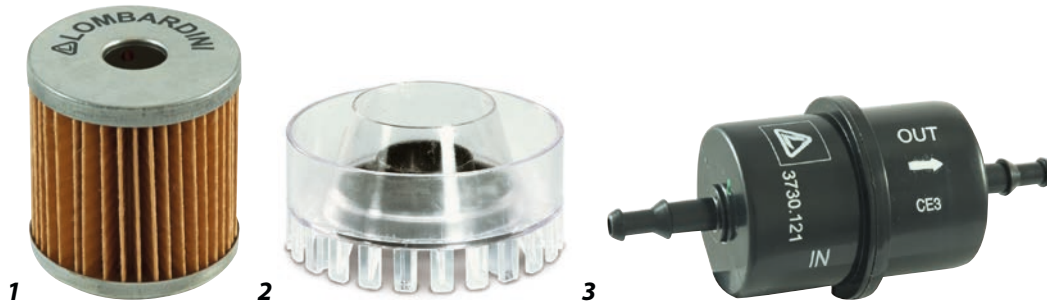

Art./Ref.	Descrizione/Description	Posizione/Position	Brand	Rif. Orig./Orig. Ref.
LOMB2175.009	Filtro piccoli motori /Small engine filter	1	LOMBARDINI	2175.009
LOMB2175.032		1		2175.032
LOMB3730.121		3		3730.121
LOMB1301.053	Parte trasparente prefiltra /Transparent prefilter part	2		1301.053
LOMB1301.069		2		1301.069

**FILTRI CARBURANTE IN PLASTICA**

FILTRES CARBURANT EN PLASTIQUE  
 PLASTIC FUEL FILTERS  
 KRAFTSTOFFFILTER AUS KUNSTSTOFF  
 FILTROS CARBURANTE DE PLASTICO

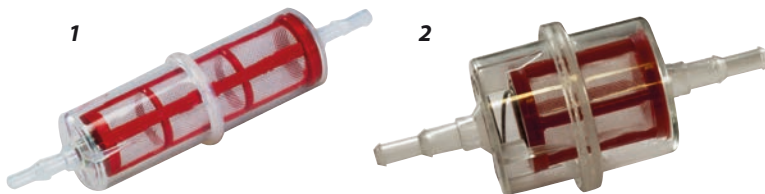

**Note:** Filtri carburante in plastica con cartuccia in rete.

**Notes:** Plastic fuel filter with mesh cartridge.

Art./Ref.	Descrizione estesa/Extended Description	Pos.
81239	Filtro carburante in plastica con cartuccia in rete, lungo 120 mm e ø 6/8 mm - <b>MADE IN ITALY</b>	2
12239	Filtro carburante in plastica con cartuccia in rete, lungo 204 mm e ø 8/10 mm.	1
91239	Filtro carburante in plastica con cartuccia in rete, lungo 204 mm e ø 8/10 mm - <b>MADE IN ITALY</b>	1

**CHIAVE FILTRO A CATENA**

CLE FILTRE A CHAINE  
 CHAIN KEY FOR FILTER  
 FILTERSCHLÜSSEL MIT KETTE  
 LLAVE FILTRO CON CADENA



Art./Ref.	Note/Notes
01030	Peso 0,31 Kg. /Weight 0,31 Kg.

**FILTRO ARIA ADATTABILE COTIEMME CON FORO CENTRALE***FILTRE AIR PERCÉ ADAPTABLE POUR COTIEMME**AIR FILTER WITH CENTRAL HOLE ADAPTABLE TO COTIEMME**LUFTFILTER MIT ZENTRALBOHRUNG PASSEND ZU COTIEMME**FILTRO DE AIRE CON ORIFICIO CENTRAL ADAPTABLE COTIEMME*

Art./Ref.	Diametro interno mm/ Inside diameter mm	Diametro esterno mm/ Outside diameter mm	Brand	Applicazione/Application	Rif. Orig./Orig. Ref.
<b>08263</b>	39	140	<b>COTIEMME</b>	CA350	5/1768

**FILTRO ARIA CON ATTACCO DISASSATO ADATTABILE.ACME***FILTRE AIR DESAXÉ ADAPTABLE POUR ACME**AIR FILTER WITH DISAXED CONNECTION APTABLE TO ACME**LUFTFILTER MIT VERSCHOBENEM ANSCHLUSS PASSEND ZU ACME**FILTRO DE AIRE CON ENGANCHE DESENCAJADO ADAPTABLE ACME*

Art./Ref.	Diametro interno mm/ Inside diameter mm	Diametro esterno mm/ Outside diameter mm	Brand	Applicazione/Application	Rif. Orig./Orig. Ref.
<b>08260</b>	39	120	<b>ACME</b>	AL215-AL290	387140

**FILTRO ARIA CON FORO CENTRALE ADATTABILE LOMBARDINI***FILTRE AIR PERCÉ ADAPTABLE POUR LOMBARDINI**AIR FILTER WITH CENTRAL HOLE ADAPTABLE TO LOMBARDINI**LUFTFILTER MIT ZENTRALBOHRUNG PASSEND ZU LOMBARDINI**FILTRO DE AIRE CON ORIFICIO CENTRAL ADAPTABLE LOMBARDINI*

Art./Ref.	Diametro interno mm/ Inside diameter mm	Diametro esterno mm/ Outside diameter mm	Brand	Applicazione/Application	Rif. Orig./Orig. Ref.
<b>08264</b>	43	145	<b>LOMBARDINI</b>	LA 400 - 490	3700.047

**FILTRO ARIA CON ATTACCO DISASSATO ADATTABILI MOTORI ACME**

FILTRE AIR DESAXÉ POUR MOTEURS ADAPTABLE ACME

AIR FILTER WITH DISAXED CONNECTION FOR ADAPTABLE ACME MOTORS

LUFTFILTER MIT VERSCHOBENEM ANSCHLUSS FÜR PASSEND ZU ACME MOTORE

FILTRO DE AIRE CON ENGANCHE PARA ADAPTABLE MOTORES ACME

Art./Ref.	Diametro interno mm/ Inside diameter mm	Diametro esterno mm/ Outside diameter mm	Brand	Applicazione/Application	Rif. Orig./Orig. Ref.
<b>08261</b>	39	145	<b>ACME</b>	AL330	387141
<b>08262</b>	50	145		FE82-VT88-VT94-AL480-550	387142



**PREFILTRI CICLONE COMPLETI ADATTABILI LAMBORGHINI**

CYCLON AIR FILTER COMPLETE ADAPTABLE TO LAMBORGHINI

CYCLON AIR FILTER COMPLETE ADAPTABLE LAMBOIRGHINI

VORFILTER KPLT. PASSEND ZU LAMBORGHINI

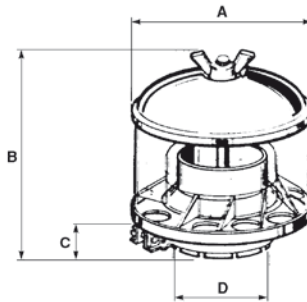
PREPULIFICADORES CICLON ADAPTABLE LAMBORGHINI



Art./Ref.	A mm	B mm	C mm	D mm	Note/Notes	Brand	Applicazione/Application	Rif. Orig./Orig. Ref.
<b>00385</b>	135	120	22	58	Parte trasparente Art. 00716 /Transparent part Art. 00716	<b>LAMBORGHINI</b>	LAMBORGHINI	-

<b>00385</b>	135	120	22	58	Parte trasparente Art. 00716 /Transparent part Art. 00716	<b>LANDINI</b>	5500, 5830, 5840, 5860, 5870, 6030, 6040, 6060, 6070, 6500, 6830, 6840, 6860, 6870, 7500, 7830, 7860, 7870, 8500, 8830, 8860, 8870, C4500, C6500, C6830, CF6830, CINGOLATI: C4830, CINGOLATI: C5500, CINGOLATI: C5830, CINGOLATI: CF4830, CINGOLATI: CF5030, CINGOLATI: CF5830, CINGOLATI: CF6030, CINGOLATI: CF6060, TREKKER: C75, TREKKER: CF65, TREKKER: CF75	976611M91
--------------	-----	-----	----	----	---	----------------	--	-----------

<b>00383</b>	100	85	16	40	Parte trasparente Art. 00718/Transparent part Art. 00718	<b>LOMBARDINI</b>	LOMBARDINI	6727.031
<b>00384</b>	120	105	18	48	Parte trasparente Art. 00717/Transparent part Art. 00717		LOMBARDINI	6727.028

<b>00385</b>	135	120	22	58	Parte trasparente Art. 00716 /Transparent part Art. 00716	<b>MASSEY FERGUSON</b>	MASSEY FERGUSON	976611M91
--------------	-----	-----	----	----	---	------------------------	-----------------	-----------

<b>00383</b>	100	85	16	40	Parte trasparente Art. 00718/Transparent part Art. 00718	<b>RUGGERINI</b>	RUGGERINI	670.05
<b>00384</b>	120	105	18	48	Parte trasparente Art. 00717/Transparent part Art. 00717		RUGGERINI	670.06

<b>00383</b>	100	85	16	40	Parte trasparente Art. 00718/Transparent part Art. 00718	<b>SLANZI</b>	SLANZI	6727.031
<b>00384</b>	120	105	18	48	Parte trasparente Art. 00717/Transparent part Art. 00717		SLANZI	6727.028
<b>00385</b>	135	120	22	58	Parte trasparente Art. 00716 /Transparent part Art. 00716		DVA 1750, SLANZI	6727.030

<b>00436</b>	173	130	28	65	Parte trasparente Art. 00788/Transparent part Art. 00788			
<b>00442</b>	270	212	57	96	Parte trasparente Art. 00789/Transparent part Art. 00789			

**FILTRO ARIA PER MOTOZAPPE CON CAPPELOTTO ADATTABILE BETA**

FILTRE AIR ADAPTABLE POUR BETA  
 AIR FILTER ADAPTABLE TO BETA  
 LUFTFILTER PASSEND ZU BETA  
 FILTRO AIRE ADAPTABLE BETA

**MADE in ITALY**



Art./Ref.	H mm	Diametro esterno mm/ Outside diameter mm	Flangia Collegamento Diametro/ Flange connection diameter	Note/Notes	Brand	Applicazione/Application
08281	209	96	40	Massa filtrante Art. 01020 /Art. 01020 Filtering element	BETA	B125
					BRUNI	BRUNI
					EUROSYSTEMS	LAUZ
					JLO	L101, L125, L152
					MAB	MAB
					MORINI	C27
					SEP	SEP
ZANETTI	ZANETTI					

**FILTRO ARIA A BAGNO D'OLIO CON PREFILTRO A CICLONE ADATTABILE LOMBARDINI**

FILTRE A AIR AVEC PREFILTRE COMPLET ADAPTABLE LOMBARDINI  
 AIR FILTER WITH CYCLON AIR FILTER ADAPTABLE LOMBARDINI  
 LUFTFILTER IN ÖLBAD MIT VORFILTER PASSEND ZU LOMBARDINI  
 FILTRO DE AIRE EN BAÑO DE ACEITE CON PREPURIFICADOR A CICLÓN ADAPTABLE LOMBARDINI

**MADE in ITALY**



Art./Ref.	H mm	Ø esterno mm/ Outside Ø mm	Flangia Collegamento Interasse/Flange connection wheelbase	Flangia Collegamento Ø/ Flange connection Ø	Note/Notes	Brand	Applicazione/Application	Rif. Orig./Orig. Ref.
08270	285	130	72	34	Massa filtrante Art. 01037/ Art. 01037 Filtering element	LOMBARDINI	4LD 640 - 4LD 705 - 4LD 820, 7LD 600, 7LD 665C - 7LD665F, 7LD 740, LDA 100 - LDA 820, LDA 710 - LDA 720 - LDA740, LDA 96 - LDA 97	3700.140
08288	285	130	56	34	Massa filtrante Art. 00992 /Art. 00992 Filtering element		400 - 6LD400C - 400V, 503, 520, 522, 530, 6LD260 - 260C, 6LD325 - 325C, 6LD360 - 360C, 6LD360V, LDA 500	3700.107
08290	285	130	62	32	Massa filtrante Art. 00992 - Parte tras-p. Art. 03484 /Filtering element Art. 00992 - Transparent part Art. 03484		3LD 450 - 3LD 450S, 3LD 510 - 3LD 510L, 3LD 535L, 4LD 640, LDA 450 - LDA 510	3700.102
08292	270	120	56	32	Massa filtrante Art. 00984 - Parte tras-p. Art. 03491 /Filtering element Art. 00984 - Transparent part Art. 03491		325, 325C, 360, 360C, 400, 400C, 400V, 520, 530, 6 LD 260, 6 LD 260C, 6 LD 360V, LDA 500	3700.109
08272	275	130	64	34	Massa filtrante Art. 00992 - Parte tras-p. Art. 03484 /Filtering element Art. 00992 - Transparent part Art. 03484	RUGGERINI	RD 101 - RD 105 - RD 850, RD 80 - RD 90 - RD 95 - RD 100, RD 900 - RD 901, RD 920 - RD 950, RF 101 - RF 109 - RF 120, RF 121 - RF 129 - RF 130, RF 139 - RF 140 - RF 148, RF 149 - RW 101 - RW 120, RF 80 - RF 81 - RF 88 - RF 89, RF 90 - RF 91 - RF 100, RP 850 - RP 900, RW 128 SERIE BRIO	388.29

**FILTRO ARIA A BAGNO D'OLIO CON CAPPELOTTO ADATTABILE LOMBARDINI**

FILTRE A AIR AVEC PREFILTRE CABOCHON ADAPTABLE LOMBARDINI

AIR FILTER WITH HEAD ADAPTABLE LOMBARDINI

LUFTFILTER IN ÖLBAD MIT KAPPE PASSEND ZU LOMBARDINI

FILTRO DE AIRE EN BAÑO DE ACEITE CON TAPA ADAPTABLE LOMBARDINI



Art./Ref.	H mm	Ø esterno mm/ Outside Ø mm	Flangia Collegamento Interasse/ Flange connection wheelbase	Flangia Collegamento Ø/ Flange connection Ø	Note/Notes	Brand	Applicazione/Application	Rif. Orig./Orig. Ref.
<b>08269</b>	250	130	72	34	Massa filtrante Art. 00992 - Cappello Art. 08299/ Filtering element Art. 00992 - Filter head Art. 08299	<b>LOMBARDINI</b>	100, 4 LD 640, 640L, 665 - 7LD665C - 7LD665F, 705, 7LD600, 7LD740, 820, 820L, 96, 97, LDA 710 - LDA 720 - LDA 740, LDA 91	3700.139
<b>08289</b>	239	130	62	34	Massa filtrante Art. 00992 - Cappello Art. 08299/ Filtering element Art. 00992 - Filter head Art. 08299		3LD 450 - 3LD 450S, 3LD 510 - 3LD 510L, 3LD 535L, 4LD 640, LDA 450 - LDA 510	3700.101
<b>08291</b>	250	120	56	32	Massa filtrante Art. 00992 - Cappello Art. 08297/ Filtering element Art. 00992- Filter head Art. 08297		325, 360, 360C, 400, 400C, 400V, 520, 530, 6 LD 260, 6 LD 260C, 6 LD 360V, LDA 500	3700.111

**FILTRO ARIA COMPLETO ADATTABILE FIAT**

FILTRE AIR COMPLETE ADAPTABLE FIAT

COMPLETE AIR FILTER ADAPTABLE TO FIAT

LUFT FILTER KPLT PASSEND ZU FIAT

FILTRE AIRE COMPLETO ADAPTABLE FIAT

Art./Ref.	Note/Notes	Brand	Applicazione/Application	Rif. Orig./Orig. Ref.
<b>15196</b>	Filtro a bagno d'olio/Oil bath filter	<b>FIAT</b>	45.66/DT, 50.66/DT, 55.56/DT, 55.88/DT, 60.56/DT, 60.93/DT, 65.56/DT, 65.93/DT, 70.56/DT 70.88/DT, 72.93/DT, 80.66/DT, 80.88/DT, 82.93/DT	5136557, 5136558, 8323083
<b>15196</b>		<b>NEW HOLLAND</b>	L60, L65, L75, TK60-65, TK60-65 M, TK60-65 V, TK70-65, TK70-65 M, TK80-65, TL100, TL65, TL70, TL80, TL90	5136557, 5136558, 8323083
<b>15196</b>		<b>FORD</b>	3435, 3935, 4635, 4835, 5635	5136557, 5136558, 8323083

**GANCIO FILTRO ARIA**

CROCHET FILTRE AIR

AIR FILTER HITCH

VERSCHLUSS FÜR LUFTFILTER

JUNTA FILTRO DE AIRE

Art./Ref.	Note/Notes
<b>01342</b>	Peso 0,03 Kg/Weight 0,03 Kg





**CAPPELOTTI FILTRO**

CABOCHONS POUR FILTRES  
 FILTERS HEADS  
 FILTERDECKEL  
 TAPA FILTRO

Art./Ref.	H mm	Ø interno mm/ Inside Ø mm	Ø esterno mm/ Outside Ømm	Note/Notes	Brand	Applicazione/Application
08299	43	45	95	Filtro Art. 08299 /Filter Art. 08299/	A.M.A.	PER FILTRO ART. 08269
08297	50	56	125	Filtro Art. 08291 /Filter Art. 08291/	A.M.A.	PER FILTRO ART. 08291



**PREFILTRO CICLONE COMPLETO ADATTABILE RUGGERINI**

PREFILTRE COMPLET ADAPTABLE RUGGERINI  
 CYCLON AIR FILTER COMPLETE ADAPTABLE TO RUGGERINI  
 VORFILTER KPLT. PASSEND ZU RUGGERINI  
 PREPURIFICADORES CICLON COMPLETAS ADAPTABLE RUGGERINI

Art./Ref.	A mm	B mm	C mm	D mm	Brand	Applicazione/Application	Rif. Orig./Orig. Ref.
00369	87	60	84	38	RUGGERINI	MD 150, RD180, RD210, RD220	670.14
00382	105	66	112	48		CRD/2, RD/2	670.15

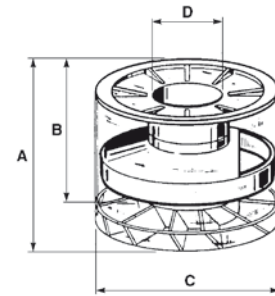

**PARTI TRASPARENTI PER PREFILTRI CICLONE ADATTABILI ACME**

PARTIES TRANSPARENTES POUR PREFILTRES CYCLON ADAPTABLE ACME  
 ELEMENTS ADAPTABLE TO ACME CYCLON FILTERS  
 GLÄSER FÜR VORFILTER PASSEND ZU ACME  
 PARTES TRASPARENTES PARA PREPURIFICADORES CICLÓN ADAPTABLE ACME

**MADE in ITALY**



Art./Ref.	H mm	Ø esterno mm/ Outside Ø mm	Ø interno mm/ Inside Ø mm	Note/Notes	Brand	Applicazione/Application	Rif. Orig./Orig. Ref.
00717	60	117	47	Prefiltro Art. 00384 /Prefilter Art. 00384	ACME	ADN 54 - 60	059038
00718	47	100	40	Prefiltro Art. 00383 /Prefilter Art. 00383		ACME	059130
00718	47	100	40	Prefiltro Art. 00383 /Prefilter Art. 00383	BETA	BETA	-
00788	87	173	65	Prefiltro Art. 00436 /Prefilter Art. 00436	FIAT	FIAT	-
00718	47	100	40	Prefiltro Art. 00383 /Prefilter Art. 00383	JLO	JLO	-
00716	63	136	58	Prefiltro Art. 00385 /Prefilter Art. 00385	LAMBORGHINI	LAMBORGHINI	-
00788	87	173	65	Prefiltro Art. 00436 /Prefilter Art. 00436	LANDINI	LANDINI	-
00789	101	270	96	Prefiltro Art. 00442 /Prefilter Art. 00442		LANDINI	-
00718	47	100	40	Prefiltro Art. 00383 /Prefilter Art. 00383	MAB	MAB	-
00718	47	100	40	Prefiltro Art. 00383 /Prefilter Art. 00383	MINARELLI	MINARELLI	-
00718	47	100	40	Prefiltro Art. 00383 /Prefilter Art. 00383	MORINI	MORINI	-
00718	47	100	40	Prefiltro Art. 00383 /Prefilter Art. 00383	PASBO	PASBO	-
00717	60	117	47	Prefiltro Art. 00384 /Prefilter Art. 00384	RUGGERINI	RD901/2 - RD92/2	059.38
00718	47	100	40	Prefiltro Art. 00383 /Prefilter Art. 00383		-	059.36
00717	60	117	47	Prefiltro Art. 00384 /Prefilter Art. 00384	SLANZI	DVA 1030	9710.084
00718	47	100	40	Prefiltro Art. 00383 /Prefilter Art. 00383		-	9710.099
00718	47	100	40	Prefiltro Art. 00383 /Prefilter Art. 00383	ZANETTI	ZANETTI	-

**PARTI TRASPARENTI PER PREFILTRI CICLONE ADATTABILI LOMBARDINI**
*PARTIES TRANSPARENTES POUR PREFILTRES CYCLON ADAPTABLE LOMBARDINI*
*ELEMENTS ADAPTABLE TO TO LOMBARDINI CYCLON FILTERS*
*GLÄSER FÜR VORFILTER PASSEND ZU LOMBARDINI*
*PARTES TRASPARENTES PARA PREPURIFICADORES CICLÓN ADAPTABLE LOMBARDINI*

Art./Ref.	H mm	Ø esterno mm/ Outside Ø mm	Ø interno mm/ Inside Ø mm	Brand	Applicazione/Application	Rif. Orig./Orig. Ref.
00095	67	120	60	LOMBARDINI	450, 451, 503, 520, 522, 530, 6 LD 260, 6 LD 325, 6 LD 360, 6 LD 400, LDA500	1301.053
00096	73	140	70		100, 3 LD 450, 3 LD 510, 4 LD 640, 4 LD 705, 510, 705, 720, 820, 832, 904, 914, 96, 97, LDA450	1301.069

**PARTI TRASPARENTI PER PREFILTRI CICLONE ADATTABILI ACME**
*PARTIES TRANSPARENTES POUR PREFILTRES CYCLON ADAPTABLE ACME*
*ELEMENTS ADAPTABLE TO TO ACME CYCLON FILTERS*
*GLÄSER FÜR VORFILTER PASSEND ZU ACME*
*PARTES TRASPARENTES PARA PREPURIFICADORES CICLÓN ADAPTABLE ACME*

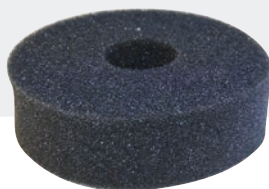

Art./Ref.	H mm	Ø esterno mm/ Outside Ø mm	Ø interno mm/ Inside Ø mm	Brand	Applicazione/Application	Rif. Orig./Orig. Ref.
03484	67	130	60	ACME	SERIE ADN MOTOZAPPE	059159
03492	70	135	62		ADN37 - ADN48	059132
03493	70	146	62		ADN45-48-54-60	059151
03484	67	130	60	LOMBARDINI	LDA450/500 - 500/530	3700.102
03484	67	130	60	RUGGERINI	RF80 - RF140	059.90
03491	54	115	55		MC70 - MC71	060-06

**MASSE FILTRANTI ADATTABILI A ACME**
*ELEMENTS DE FILTRE ADAPTABLE ACME*
*FILTER ELEMENTS ADAPTABLE TO ACME*
*FILTERMASSEN PASSEND ZU ACME*
*ELEMENTOS FILTRANTES ADAPTABLE ACME*

Art./Ref.	Brand	Applicazione/Application	Rif. Orig./Orig. Ref.
00984	ACME	ADN37-43-45-48-54-60	359127
01020	BETA	B125	-
01020	EUROSYSTEMS	EUROSYSTEMS	-
01020	JLO	L101 - 125 - 152	-
00988	LOMBARDINI	503 - 520 - 522 - 530, 6LD260 - 6LD325 - 6LD360, LDA500	5496.071
01037		3LD450 - 3LD450S, 3LD510 - 3LD510L, 3LD535L, 4LD640, 4LD640 - 4LD705, 4LD820, 7LD600, 7LD665C - 7LD665F - 7LD740, LDA100 - LDA820, LDA450 - LDA510, LDA710 - LDA720 - LDA740, LDA96 - LDA97	5496.111
18931		400, 6LD260 - 260C, 6LD325 - 325C, 6LD360 - 360C, 6LD360V, 6LD400C - 400V, 6LD435, LDA500 - 503 - 520 - 522 - 530	5496.113
18932		10LD400.2 - 10LD400.2/B, 10LD560.2 - 10LD360.2, 11LD535.3, 11LD625 - 11LD625.3, 3LD 450 - 3LD 450S, 3LD 510 - 3LD 510L, 3LD 535L, 4LD 640, 4LD 705 - 4LD 820, 7LD600, 7LD665C - 7LD665F, 7LD740, 8LD600.2 - 8LD665.2 - 8LD740.2, 9LD560.2 - 9LD561.2, 9LD625 - 9LD625.3, LDA100 - LDA820, LDA450 - LDA510, LDA710 - LDA720 - LDA740, LDA904 - LDA914 - LDA940, LDA96 - LDA97	5496.110
19144		LDA672 - LDA673 - LDA674, LDA832 - LDA833 - LDA834	5496.074
01020	MAB	MAB	-
01020	MORINI	C27	-
01020	PASBO	PASBO	-
00992	RUGGERINI	RD180 - RD210, RF80 - RF140	359-26
01020	SEP	SEP	-
00992	SLANZI	DVA1030, DVA700 - DVA700S, DVA790 - DVA790S, DVA920	5496.132
01020	ZANETTI	17512	-

# 1.7.7 Motorini d'avviamento e alternatori

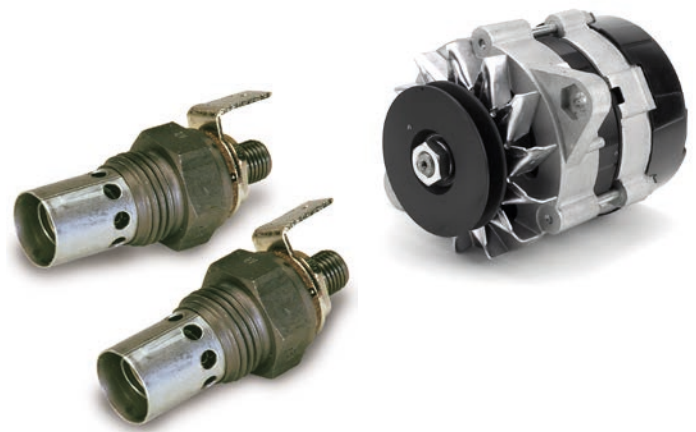
Starter motor and alternator



**ama**

**Ricambi & accessori per macchine agricole**

**SPARE PARTS & ACCESSORIES FOR AGRICULTURAL MACHINE**

Tutti gli articoli della presente sezione, prodotti da AMA SPA e/o da terzi per conto di AMA, sono adattabili ("non originali") alle marche indicate ai sensi di quanto previsto dal REG. CE n. 1400/2002. I diritti sui marchi citati appartengono ai legittimi proprietari ed il loro uso ha l'esclusiva finalità di consentire all'utilizzatore la comparazione dei diversi prodotti. All items of this section, manufactured by AMA SPA and/or any third party on behalf of AMA, are adaptable ("non-original") to the brands listed under the provisions of the REG. CE n. 1400/2002. The rights on the trademarks belong to their respective owners and their usage is only aimed to allow the user to compare different products.

**TERMOAVVIATORI ADATTABILI**

THERMODEMARREURS ADAPTABLE

THERMOSTARTERS ADAPTABLE

THERMOANLASSER PASSEND ZU

TERMOARRANCADOR ADAPTABLE

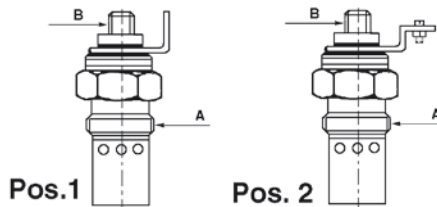

Art./Ref. AMA	BERU	CHAMPION	FIAT	LUCAS - CAV	MARELLI	TECNOMECCANICA
<b>Termoavviatori/Thermostarters</b>						
<b>05068</b>	161 GS	-	5141702	1854104	CTZ 2 U	-
<b>05069</b>	-	-	4724604	1854105	CTZ 4 U	-
<b>05070</b>	154 GS	-	-	1854050	CTZ 5 U	-
<b>05071</b>	-	-	-	1854101	CTZ 1 U	-
<b>05072</b>	166 GS	-	4221168	1854103	CTZ 3 U	-

Art./Ref.	Pos.	Volt	Filetto A/ Thread A	Filetto B/ Thread B	Chiave/ Key	Preriscaldamento/ Pre-heating	Brand	Applicazione/Application	Rif. Orig./Orig. Ref.
<b>05070</b>	2	12	7/8"14 UNF	3/8"24 UNF	24	15 Sec	<b>BEDFORD</b>	CF VAN, M.TJ., MODELLI R, TK5B, TUTTI I MODELLI	-

<b>05070</b>	2	12	7/8"14 UNF	3/8"24 UNF	24	15 Sec	<b>CATERPILLAR</b>	510PFLT, B10/12FLT, B15/25FLT	-
--------------	---	----	------------	------------	----	--------	--------------------	-------------------------------	---

<b>05068</b>	1	12	1/2" BSP	3/8"24 UNF	24	15 Sec	<b>FIAT</b>	1000, 1300, 455C, 480, 550, 570, 600, 605C, 640, 670, 680, 780, 850, 855C, 880, 955C, 980, TL5-TL5H	4176086, 4232051, 4724601, 5141702, 5155859, 5161845
<b>05069</b>	1	24	1/2" BSP	3/8"24 UNF	24	15 Sec		120, 315-316, 40, 50, 55, 79, 80, 90	4724604
<b>05071</b>	1	12	1/2" BSP	3/8"24 UNF	24	15 Sec		300-400-450-500-505-600DT	
<b>05072</b>	1	24	1/2" BSP	3/8"24 UNF	24	15 Sec		409-410-411-418-470	4221168 EX 4724603 EX 4232052

<b>05070</b>	2	12	7/8"14 UNF	3/8"24 UNF	24	15 Sec	<b>FORD</b>	10/15, F600, SERIE V, TRANSIT, V10, V40	-
<b>05071</b>	1	12	1/2" BSP	3/8"24 UNF	24	15 Sec		F100-F350-B600-F600-F700	-
<b>12081</b>	2	12	7/8"14 UNF	3/8"24 UNF	24	15 Sec			81806046

<b>05072</b>	1	24	1/2" BSP	3/8"24 UNF	24	15 Sec	<b>GENERAL MOTOR</b>	MOTORI318M-466F-466M-220F-200G	-
--------------	---	----	----------	------------	----	--------	----------------------	--------------------------------	---

<b>05068</b>	1	12	1/2" BSP	3/8"24 UNF	24	15 Sec	<b>IVECO</b>	100-315-316, 50-55-60-65-79-80-90	-
<b>05072</b>	1	24	1/2" BSP	3/8"24 UNF	24	15 Sec		140-159-160-170-190.35-190.36, 190.42-220-240-260-330-370	-

<b>05070</b>	2	12	7/8"14 UNF	3/8"24 UNF	24	15 Sec	<b>LANDINI</b>	R4500, R7000, R8000, T 20N, TL16C, TL16N	893501M1
<b>12081</b>	2	12	7/8"14 UNF	3/8"24 UNF	24	15 Sec			1446935M1

<b>05070</b>	2	12	7/8"14 UNF	3/8"24 UNF	24	15 Sec	<b>LAVERDA</b>	M 120 -M 120R -COMBINE	-
--------------	---	----	------------	------------	----	--------	----------------	------------------------	---

<b>05070</b>	2	12	7/8"14 UNF	3/8"24 UNF	24	15 Sec	<b>LEYLAND</b>	BOXER : TUTTI I MODELLI	-
--------------	---	----	------------	------------	----	--------	----------------	-------------------------	---

<b>05070</b>	2	12	7/8"14 UNF	3/8"24 UNF	24	15 Sec	<b>MASSEY FERGUSON</b>	TUTTI I MODELLI	893501M91
<b>12081</b>	2	12	7/8"14 UNF	3/8"24 UNF	24	15 Sec		VARI MODELLI	3583543M2

<b>05070</b>	2	12	3/8"24 UNF	7/8"14 UNF	24	15 Sec	<b>MOTOR IBERICA</b>	TUTTI GLI AUTOCARRI	-
--------------	---	----	------------	------------	----	--------	----------------------	---------------------	---

<b>05070</b>	2	12	7/8"14 UNF	3/8"24 UNF	24	15 Sec	<b>PERKINS</b>	MOTORI VARI	2666103
<b>12081</b>	2	12	7/8"14 UNF	3/8"24 UNF	24	15 Sec			2666108

<b>05068</b>	1	12	1/2" BSP	3/8"24 UNF	24	15 Sec	<b>SAME</b>	CORSARO 70, LEONE 75, SATURNO 80	-
--------------	---	----	----------	------------	----	--------	-------------	----------------------------------	---

Art./Ref.	Pos.	Volt	Filetto A/ Thread A	Filetto B/ Thread B	Chiave/ Key	Preriscaldamento/ Pre-heating	Brand	Applicazione/Application	Rif. Orig./Orig. Ref.
05070	2	12	7/8" UNF	3/8" UNF	24	15 Sec	SAVIEM RENAULT	S1000, S5800, S7, S8, SB2, SC5, SD4T, SG2, SG4T, SG5SM5	-
05071	1	12	1/2" BSP	3/8" UNF	24	15 Sec	UNIVERSAL	U400-L400-V400	-
05070	2	12	7/8" UNF	3/8" UNF	24	15 Sec	VOLVO	950SB30 COMBINE, D430, S800 COMB.SM462 COMB., S900, S900 COMBINE, ST265, ST280., T430, VF82, VF83	-

**SERBATOIO ALIMENTAZIONE TERMOAVVIATORE ADATTABILE**

RESERVOIR ADAPTABLE  
 TANK FOR CHOKE ADAPTABLE  
 BEHÄLTER/TANK FÜR VORGLÜHANLASSER (CHOKE) PASSEND ZU  
 DEPÓSITO ADAPTABLE



Art./Ref.	Note/Notes	Brand	Applicazione/Application	Rif. Orig./Orig. Ref.
14059	Serbatoio per alimentazione termoavviatore/Plastic thermostarter tank	FORD	8430, 8830	-
		FIAT	100.90DT, 110.90DT, 140.90DT, 160.90DT, 180.90DT, 70.90DT, 90.90DT	4613792, 5118586, 5135039, 5135040

**CANDELETTE PRERISCALDAMENTO ADATTABILI FIAT**

BOUGIES DE PRECHAUFFAGE ADAPTABLE FIAT  
 GLOW PLUGS ADAPTABLE FIAT  
 ERWÄRMUNGSGLÜHKERZEN PASSEND ZU FIAT  
 BUJITAS PRECALENTAMIENTO ADAPTABLE FIAT

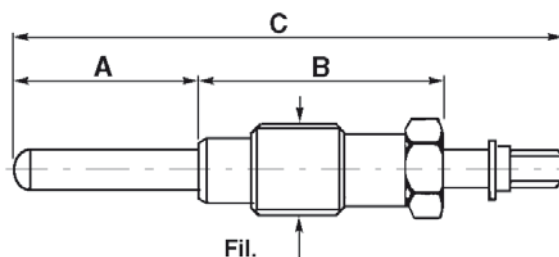

Art./Ref. AMA	BERU	CHAMPION	FIAT	LUCAS - CAV	MARELLI	TECNOMECCANICA
<b>Candelette preriscaldamento/Glow plugs</b>						
05064	145 M	-	980611	-	CIM 4A	6240707 R 12
05065	-	-	4137983	-	CIM 14A	6240720 R 12
05066	128 M	-	975331	-	CIM 4B	6240407 R 24
05067	-	-	4122453	-	CIM 14B	6240420 R 24

Art./Ref.	A mm	B mm	C mm	Volt	Filetto A/ Thread A	Chiave/Key	Preriscaldamento/ Pre-heating	Note/Notes	Brand	Applicazione/Application	Rif. Orig./Orig. Ref.
05064	25	39	99,5	12	M 18x1,5	19	22 Sec		FIAT	1400 B, 215, 241	980611
05065	24	46	106	12				Serie diamante/ Diamond line		411, 415, 615 M1	4137983
05066	25	39	99,5	24						1400 B, 215, 241	975331
05067	24	46	106	24				Serie diamante/Diamond line		411, 415, 615 M1	4122453

**CANDELE ADATTABILI ACME**

BOUGIES ADAPTABLE ACME  
 SPARK-PLUGS ADAPTABLE ACME  
 KERZEN PASSEND ZU ACME  
 BUJIAS ADAPTABLE ACME



Art./Ref.	Brand	Applicazione/Application
00635	ACME	AL480, AL550, FE82
00635	COTIEMME	CA150, CA200, CA300, IDRO, NILO, TARO, VARO
00635	CHAMPION	D16, D16J
00667		L14
00635	DENSO	L14-U
00667		W14F-U
00635	GUIDETTI	450, 500, A400
00635	LOMBARDINI	LA 65-72, LA 80-82, LA 85-90
00667		LA 205, LA 250, LA 300, LA 400, LA 490, LAL 250, LAP 205, LAP 250, LAP 300, LAP 400, LAP 490, LAV 250
00635	MARELLI	CM 2N
00667		CW4N
00635	NGK	A-6
00667		B-4H
00635	PASQUALI	MODELLI A PETROLIO
00635	SLANZI	SA14F, SA16F

**TAPPO STARTER ADATTABILE LOMBARDINI**

BOUCHON DEMARRAGE ADAPTABLE LOMBARDINI  
 STARTER CAP ADAPTABLE LOMBARDINI  
 STARTERPROPFEN PASSEND ZU LOMBARDINI  
 TAPÓN STARTER ADAPTABLE LOMBARDINI



Art./Ref.	Brand	Applicazione/Application	Rif. Orig./Orig. Ref.
00094	LOMBARDINI		9055.008
00106	ACME	TUTTI I MODELLI	890002
00106	RUGGERINI	TUTTI I MODELLI	890-01

**TAPPO SFIATO ADATTABILE LOMBARDINI**

BOUCHON RENIFLARD ADAPTABLE LOMBARDINI  
 BREATHER CAP ADAPTABLE LOMBARDINI  
 ENTLÜFTUNGSDECKEL PASSEND ZU LOMBARDINI  
 TAPÓN RESPIRADERO ADAPTABLE LOMBARDINI



Art./Ref.	Brand	Applicazione/Application	Rif. Orig./Orig. Ref.
<b>01200</b>	<b>LOMBARDINI</b>	100, 3 LD 510, 4 LD 705, 450, 6 LD 360, 820, 91, 96, 97, LA 400, LA 490, LDA 80	9050.050

**PULEGGE AVVIAMENTO ADATTABILI LOMBARDINI**

POULIES DE DEMARRAGE ADAPTABLE LOMBARDINI  
 STARTER PULLEYS ADAPTABLE LOMBARDINI  
 KEILRIEMENSCHLEIBEN PASSEND ZU LOMBARDINI  
 POLEA ARRANQUE ADAPTABLE LOMBARDINI



Art./Ref.	Brand	Applicazione/Application	Rif. Orig./Orig. Ref.
<b>01203</b>	<b>LOMBARDINI</b>	3LD510, LDA450 - 510	6961.029
<b>01208</b>		5LD260, 6LD360, LDA500 - 520 - 530	6960.069
<b>08095</b>		4LD640, 4LD705, 4LD820, LDA 96 - 97 - 100 - 820	6960.061

**MOTORINI AVVIAMENTO ADATTABILI**

MOTEUR DEMARRAGE ADAPTABLE  
 STARTER MOTOR ADAPTABLE  
 STARTER PASSEND ZU  
 MOTORES DE ARRANQUE ADAPTABLE



Art./Ref.	Volt	Kw	N° denti/Teeth n°	Brand	Applicazione/Application	Rif. Orig./Orig. Ref.
<b>26490</b>	12	2,7	9	<b>BOSCH</b>		0.001.362.032, 0001109405
<b>93004</b>	12	2,7	9			0001362017, 0001362018, 0001362040, 0001362076
<b>93006</b>	12	2,7	9			0001354067, 0001354097, 0001354099, 0001362021, 0001362050

Art./Ref.	Volt	Kw	N° denti/Teeth n°	Brand	Applicazione/Application	Rif. Orig./Orig. Ref.
93005	12	2,7	11	<b>BOSCH</b>		0001362011, 0001362059, 0986016200
43032	12	2,8	10		0986018151	
26491	12	3	9		0.001.359.102, 0.001.367.028, 0001262008	
53285	12	3	9		0001262029	
92940	12	3	9		0001359049, 0001359073, 0001359078, 0001367004, 0986011200	
93007	12	3	9		0001359017, 0001359062, 0001367021	
51732	12	3	11		0001262031	
91726	12	3,2	9		0001359021, 0001359102, 0001367028, 0001367082, 0986011220, 0986011221	
91725	12	3,2	10		9007044014	
91723	12	4,2	9		0001230006, 0001230014, 0986016550, 0986019020, 0986019547	
93008	12	4,2	9		0001262029, 0001262030, 0986024080	
93003	24	3,1	9		0001363101, 0001363111, 0986011160, 0986011161	
92941	24	3,1	9		0001363110	
61344	12	1,8	9		0001109029	
61342	12	1,2	9		0001107042	
ISKRAIS0509	12	2,8	10		0001367040, 9000143416	
ISKRAIS0520	12	2,7	10		0001362049	
ISKRAIS1249	12	3,4	9		0001230012, 0001262029, 0001262030, 0986024080	
93004	12	2,7	9	<b>CARRARO</b>	SUPERTIGRE 625L,, SUPERTIGRE 635, SUPERTIGRE 650, SUPERTIGRE 835, SUPERTIGRE 850, TIGRONE ATLAS 750,, TIGRONE TROPICAL 750	
92940	12	3	9		3100-4, 3300-4, 3400-4, 3500-4, 5.1000, 6.1000, 7.1000, 8.1000	130652
93010	12	2,8	10	<b>CASE</b>	1394, 1494, 1594, 1690, 1694	234987A1
ISKRAIS0509	12	2,8	10		TY2P, 3944, 3945, 3960, 3961	V941501, V941501EX
92940	12	3	9		60CX50, 75, CS68, CX50, CX60	388186A1
60270	12	3	10		3210, 3220, 3230, 385, 395, 4210, 4220, 4230, 4240, 454, 474, 485, 495, 574, 584, 595, 674, 684, 685, 695, 784, 785, 795, 884, 895	189330A5, 230428A1, 230428A3, 27508, 529965R93, 537140R92
60276	12	3	10		353, 383, 433, 440, 453, 523, 533, 540, 633, 640, 733, 833	3228192R91, 3228192R91EX
91726	12	3,2	9		JX 1095	2022506, 4169093, 4692478, 4699705, 4702248, 4737755, 4755109, 4763996, 4807375, 4832942, 87376493, 88205006, 9972215
91725	12	3,2	10		MXM 120, MXM 130, MXM 140,, MXM 155, MXM 175, MXM 190	82013134, 82014160, 82015723, 82021372, 84017265, 87318759, 87653221, 87755550
91723	12	4,2	9		3944, 3945, 3960, 3961	73328004
93008	12	4,2	9			1530289C1
ISKRAIS1249	12	3,4	9			
ISKRAIS0520	12	2,7	10	<b>CLAAS</b>		6005700082
ISKRAIS0509	12	2,8	10			6005700081
43032	12	2,8	10			6005706629
41134	12	2,8	10		CONSUL, DOMINATOR 58S, DOMINATOR 68S/78S, DOMINATOR 85, MERKATOR 50, MERKATOR 60/75	-
92940	12	3	9		MERCATOR 60, MERCATOR 75R	V941501, V941501EX, 6005016395
93007	12	3	9			6005706620
91725	12	3,2	10			11327170



Art./Ref.	Volt	Kw	N° denti/Teeth n°	Brand	Applicazione/Application	Rif. Orig./Orig. Ref.
91723	12	4,2	9	CLAAS	TELEHANDLERS SCORPION 6030,, TELEHANDLERS SCORPION 7055,, TELEHANDLERS SCORPION 9055	6005025776
60278	24	5,4	9		116CS, CO228, JAGUAR 685SL, JAGUAR 690SL, JAGUAR 695SL, JAGUAR 820, JAGUAR 840, JAGUAR 860, JAGUAR 880	
60260	12	2,7	11	DAVID BROWN	1200, 1210, 1212, 1290, 1294, 1390, 1394, 1410, 1412, 1490, 1494, 850, 880, 950, 990, 995, 996	K262746, K262819, K957340
93004	12	2,7	9	DEUTZ	F1L410, F1L411D, F1L411W,, F2L410	2.9619.510.0
92940	12	3	9		D4006, D4506, D5206, D6206, D6806, D7206, DX110, DX85,, DX90, INTRAC2002, INTRAC2003,, INTRAC2004, INTRAC2004, M980, M1002, M1202, M1300, M2480,, M2580, M2680, M900, M980	1161384, 1163669, 1164994, 1173240, 1174166
51730	12	3	9		1000, 10006 MOD., 1002, 1080, 120, 1202, 13006, 2003, 2004, 2005, 2385, 2480, 2580, 2680, 4.50, 4.51, 4.70, 4.71, 50, 6.05, 6.10, 6.30, 6.31, 6.45, 6.50, 6.60, 6.71, 6.81, 6006, 6007, 6206, 6207, 6806, 6807, 6907, 7.10, 7006, 7007, 7206, 7207, 7807, 8.30, 80, 8005, 8006, 85, 86, 90, 9005, 9006, 92, AGROCOMPACT 3.50-3.90, AGROLUX 60, AGROLUX 70, AGROPLUS 60, AGROPLUS 70, AGROPRIMA 3.30-3.50-4.11-4.31, INTRAC, INTRAC 2002, M980	01182233
53285	12	3	9		AGROCOMPACT 60, AGROCOMPACT 70, AGROCOMPACT 80, AGROCOMPACT 90	2.9619.290.0/10, 2.9619.380.0, 2.9619.390.0, 2.9619.560.0
51732	12	3	11		3005, D2505, D30	2.9619.180.0, 2.9619.400.0, 2.9619.562.0
60267	12	3,6	9		5670HTS, 5680HTS, 5690HTS	16028248
93008	12	4,2	9		AGROCLIMBER 410, AGROCLIMBER F400,, AGROCLIMBER F410,, AGROCOMPACT F100DT,, AGROCOMPACT F75DT,, AGROCOMPACT F90DT,, AGROLUX 4.80E, AGROLUX 410,, AGROPLUS 405, AGROPLUS 410,, AGROPLUS 410F ECO,, AGROPLUS 420, AGROPLUS 420F,, AGROPLUS 430 F/S/V,, AGROPLUS F55, AGROPLUS F65, SERIE 5G, AGROCLIMBER 410,	2.9619.230.0, 2.9619.390.0, 2.9619.560.0, 2.9619.565.0, 2.9939.295.0
ISKRAIS1249	12	3,4	9		AGROFARM 80, AGROFARM 100,, AGROLUX 60, AGROLUX 70,, AGROLUX 80, AGROLUX 90, AGROPLUS 80A, AGROPLUS 85A,, AGROPLUS 95A, AGROPLUS 100A, AGROTRON 100, AGROTRON 105,, AGROTRON 106, AGROTRON 110,, AGROTRON 1130TTV,, AGROTRON 1145TTV,, AGROTRON 115, AGROTRON 160,, AGROTRON 1160TTV,, AGROTRON 120, AGROTRON 130, AGROTRON 135,, AGROTRON 150,, AGROTRON 150.7,, AGROTRON 165, AGROTRON 165.7,, AGROTRON 175,, AGROTRON 180.7,, AGROTRON 200, AGROTRON 205,, AGROTRON 215, AGROTRON 230,, AGROTRON 235, AGROTRON 260,, AGROTRON 265, AGROTRON 4.70,, AGROTRON 4.80, AGROTRON 4.85,, AGROTRON 4.90, AGROTRON 4.95, AGROTRON 6.05, AGROTRON 6.15,, AGROTRON 6.20, AGROTRON 6.30,, AGROTRON 6.45, AGROTRON 80,, AGROTRON 85, AGROTRON 90,, AGROTRON K410, AGROTRON K420,, AGROTRON K430, AGROTRON K610,, AGROTRON M600, AGROTRON M610,, AGROTRON M620, AGROTRON M640,, AGROTRON M650	0.9001.5728.0, 01180928, 01181976
91723	12	4,2	9			
41134	12	2,8	10		EICHER	3153, 3555, 4060, 4072, 5336
93004	12	2,7	9	FENDT	F231GT, FARMER 1E, FARMER 2DE,, FARMER 2E, FARMER 2N, FARMER2S, FARMER 4S, FARMER 5S, FIX 2E	F231903060010
51730	12	3	9		GT-GTA360, GT-GTA365, GT-GTA380, GT345, GTA390, GTA395	
92940	12	3	9		F360GT, F365GT, F370GT, F380GT, FARMER 201VA, FARMER 203P,, FARMER 203PA, FARMER 203V,, FARMER 203VA, FARMER 204P,, FARMER 204V, FARMER 270P,, FARMER 307C, FARMER 307CA,	X830100001
53287	12	3,1	9		FAVORIT509C-510C-511C-512C, FAVORIT514C-515C	
91723	12	4,2	9		F255GT, F275GT, F345GT, F350GT, F360GT, F365GT, F370GT, F380GT, F370GTA, F380GTA, F390GTA,, FARMER 200S, FARMER 200V,, FARMER 201, FARMER 203,, FARMER 204, FARMER 205,, FARMER 206, FARMER 207,, FARMER 208, FARMER 240,, FARMER 250, FARMER 260,, FARMER 270, FARMER 275,, FARMER 280, FARMER 307,, FARMER 308, FARMER 309,, FAVORIT 711, FAVORIT 712,, FAVORIT 714, FAVORIT 716,	F514900060040, F716900060010, F716900060060
26490	12	2,7	9	FORD	3435, 3830, 3935, 4030, 4135, 4635, 4835, 5635, 6635, 7635	4728682, 4807373, 500338953
22046	12	2,8	10		2000, 2310, 2600, 2610, 2910, 3000, 3430, 3600, 3610, 3910, 3930, 4000, 4100, 4110, 4130, 4600, 4610, 4630, 4830, 5000, 5030, 5110, 5610, 5700, 6000, 6410, 6600, 6610, 6700, 6710, 6810, 7000, 7400, 7600, 7610, 7700, 7710, 7810, 7910, 8000, 8100, 8210, 8600, 8630, 8700, 8730, 8830, 9000, 9600	81859398, 82005342, 83918688, 83981923, D8NN11000AA
26491	12	3	9		3010S - 4010S - 5010S, 4230-4430, 4635-4835-5635-6635-7635	4807375, 504059251
91725	12	3,2	10		8010S, 8670, 8770	82015723, 82021372
10801	12	3,5	9		8430 - 8630 - 8830	4807376

Art./Ref.	Volt	Kw	N° denti/Teeth n°	Brand	Applicazione/Application	Rif. Orig./Orig. Ref.
<b>26490</b>	12	2,7	9	<b>FIAT</b>	35.66DT-45.66DT-50.66-55.56, 350-400-420-446-450-466-470, 45.66 - 45.66 DT, 45.66S - 45.66S DT, 45.76 V, 474-480-500-500DT-530-533-540, 50.66 - 50.66 DT, 50.66S - 50.66S DT, 540DT-550-566DT-580-600DT, 55.46 - 55.46 DT, 55.56 - 55.56 DT, 55.65 F-M-V, 55.66 - 55.66 DT, 55.66F - 55.66F DT, 55.66LP - 55.66LP DT, 55.66S - 55.66S DT, 55.66V - 55.66V DT, 55.75 F-M-V, 55.76F - 55.76F DT, 55.76V - 55.76V DT, 55.85 F-M-V, 55.86F - 55.86F DT, 55.86S - 55.86S DT, 55.86S V - 55.86S V DT, 55.86V - 55.86V DT, 55.88 - 55.88 DT, 55.90 - 55.90 DT, 60.46 - 60.46 DT, 60.56 DT, 60.65 M-V, 60.66 - 60.66 DT, 60.66F - 60.66F DT, 60.66LP - 60.66LP DT, 60.66S - 60.66S DT, 60.75 M-V, 60.76F - 60.76F DT, 60.85 F-V, 60.88 - 60.88 DT, 60.90 - 60.90 DT, 60.93 - 60.93 DT, 60.94 - 60.94 DT, 62.85 M, 62.86F - 62.86F DT, 640DT-650-666DT-670DT-680DT	4807373
<b>26491</b>	12	3	9		1380DT TURBO-1580DT TURBO, 355C-455C-505C-605C, 550-580-600-640-666-670-680, 65.46 - 65.46 DT, 65.66 - 65.66 DT, 65.66S - 65.66S DT, 65.88 - 65.88 DT, 65.90 - 65.90 DT, 65.93 - 65.93 DT, 65.94 - 65.94 DT, 70.56 - 70.56 DT, 70.65 M, 70.66 - 70.66 DT, 70.66V, 70.66F - 70.66F DT, 70.66LP - 70.66LP DT, 70.66S - 70.66S DT, 70.75 M, 70.76V, 70.76F - 70.76F DT, 70.76LP - 70.76LP DT, 70.88 - 70.88 DT, 70.90 - 70.90 DT, 72.85 M, 72.93 - 72.93 DT, 72.94 - 72.94 DT, 750DT-780DT-850DT-880DT, 80.65, 80.66 - 80.66 DT, 80.66F - 80.66F DT, 80.66S - 80.66S DT, 80.75, 80.76F - 80.76F DT, 80.88 - 80.88 DT, 80.90 - 80.90 DT, 82.85 M, 82.93 - 82.93 DT, 82.94 - 82.94 DT, 85.90 - 85.90 DT, 88.85 M, 88.93 - 88.93 DT, 88.94 - 88.94 DT, 900-1000SUPER-1300SUPER	4172113, 4187122, 4692478, 4699705, 4702248, 4703751, 4737755, 4807375, 4832942
<b>91726</b>	12	3,2	9		1000, 1380, 580, 605, 640,, 65.46, 65.56, 65.66, 65.88,, 65.90, 665, 666, 670, 680,, 70-56, 70-65, 70-66, 70-75,, 70-76, 70-88, 70-90, 765, 766,, 780, 80-65, 80-66, 80-75,, 80-88, 80-90, 85-55, 85-90,, 855, 880	4692478, 4832942, 87376493
<b>10801</b>	12	3,5	9		100.90 - 100.90 DT, 110.90 - 110.90 DT, 115.90 - 115.90 DT, 130.90 - 130.90 DT, 130.90-140.90-160.90-180.90, 140.90 - 140.90 DT, 1580-1880, 1580-1880-140.90-160.90-180.90, 160.90 - 160.90 DT, 180.90 - 180.90 DT, 90.90 - 90.90 DT, 90.90-100.90-110.90-115.90, F100 - F100 DT, F110 - F110 DT, F115 - F115 DT, F120 - F120 DT, F130 - F130 DT, F140 - F140 DT	4737759, 4755110, 4807376
<b>93003</b>	24	3,1	9			6706931, 77050561, 77080560, 77080561, 929162
<b>92941</b>	24	3,1	9		312, 315, 411, 411R, 415, 441	35532026A, 4002986, 4104783, 4130796, 852962, 971961
<b>N04807378</b>	24	4	9			4807378
<b>93004</b>	12	2,7	9		<b>GOLDONI</b>	1038, 1040, 230, 236, 238, 240, 245, 336, 3445, 40B, 45B, 50B,, 834, 938, 945RS/DT,, TRANSPORTER 336, UNIVERSAL 224, UNIVERSAL 226, UNIVERSAL 230
<b>93005</b>	12	2,7	11	1055, 3050, 3070, 55, C45,, TRANSCAR 60 RS		
<b>60250</b>	12	3	9	1045R		
<b>93007</b>	12	3	9	C360		
<b>53285</b>	12	3	9	<b>HURLIMANN</b>	356,468,478,478-80,488-90, 468H,481H,491H,6136,6165,6160, 5116,5116T,6170,468-70,468CLAB, 6170TURBO-6190	2.9619.290.0/10, 2.9619.380.0, 2.9619.390.0, 2.9619.560.0
<b>51732</b>	12	3	11		345-355-355F-358-360-470-476V, 480-488T-490-496T-5110-5510, 5116T-6115ELITE-6130-6135ELITE, 6136-6150,6190MASTER-6160	2.9619.180.0, 2.9619.400.0, 2.9619.562.0
<b>93008</b>	12	4,2	9		6115-XB ELITE/DT/REV,, H466 PRESTIGE, H468 PRESTIGE,, H468.4 CLUB DT, H476V,, H478 PRESTIGE, H478.4DT,, H488 PRESTIGE DT REV,, H491XF DT, H6130, H6115, H6135, H6136, H6160, H6165 MASTER DT,, H6190 MASTER DT, SX1200,, S1350, SX1500, SX1600, SX1800,, SX1350, SX1500, SX1600, SX1800, SX2000, XA607 DT/2RM, XA657,, XA658, XA85, XB95, XF100, XF60, XF-H90 DT, XN708, XN709, XS100, XF90, XF-H100 DT, XF-H75 DT,, XS90, XT105, XT110, XT85, XT95, XT908 DT, XT909 DT,, XT910.4 DT, XT910.6 DT,, XT911, XT913	2.9619.230.0, 2.9619.390.0, 2.9619.560.0, 2.9619.565.0, 2.9939.295.0
<b>ISKRAIS1249</b>	12	3,4	9			2.9619.230.0, 2.9619.390.0, 2.9619.560.0, 2.9939.295.0
<b>41134</b>	12	2,8	10	<b>JCB</b>	110, 1250, 413, 418, 702, 704, 805, 806, 807, 808, 902, SL1000P, SL1500P,	714/29500
<b>ISKRAIS0509</b>	12	2,8	10		SL1750P, SL702P, SL704P, SL900P	
<b>51734</b>	12	3	10	<b>JOHN DEERE</b>	1020, 1030, 1040, 1065, 1075, 1075H, 1075H (BIS 1987), 1085, 1120, 1130, 1140, 1530, 1630, 1640, 1830, 1840, 2020, 2030, 2040, 2120, 2130, 2140, 2250, 2450, 2650, 2850, 2940, 3030, 3040, 3050, 3120, 3130, 3140, 330, 3350, 3650, 430, 510, 530, 6010-6100-6110, 6200-6210-6300-6310-6400-6410, 630, 710, 730, 820, 830, 840, 920, 925, 930, 932, 935, 940, 942, 945, 950, 952, 955, 960, 965, 968H, 970, 975	AL110597, AL41247, AR70436

Art./Ref.	Volt	Kw	N° denti/Teeth n°	Brand	Applicazione/Application	Rif. Orig./Orig. Ref.
93004	12	2,7	9	LAMBORGHINI	R503, R503DT, R603, R603DT	2.9619.510.0
53285	12	3	9		1356-1506-1556-1706, 704-804-854-874-880-904-950, 955-1056-1106-1156-1256-1306, FORMULA105-PREMIUM1050,1060, RACING150,165,190	2.9619.290.0/10, 2.9619.380.0, 2.9619.390.0, 2.9619.560.0
51732	12	3	11		115-135FORMULA-165-190RACING, 235-235DT-345-350-352-352L, 352S-503-503L-503S-553-573/60N, 574/60-574/60N-603-603L-603LL, 603S-613DT-653-654R-654DT, 674/70-674/70N BASSO-684-684DT, 684F-684L-684N-714T-2RM-724F, 754R-754DT-774-774/80-774/80DT, 774/80N-775/80NN-777/80-874/90	2.9619.180.0, 2.9619.400.0, 2.9619.562.0
91723	12	4,2	9		R3 100TB, R3 85TB, R6 100,, R6 110, R6 120,	0.9001.5728.0, 01180928, 01181976
93008	12	4,2	9			
ISKRAIS1249	12	3,4	9		674-70 CROSS, 674-70 SPRINT,, 674-70 GRAND PRIX,, 774-80, AGILE 775V, 775V DT,, 916, AGILE 990, 990-F PLUS,, AGILE 880, 880-F PLUS,, C110 SIX, CF100, CF78,, C647 ERGOMATIC, C754,, C774 ERGOMATIC, C874 ERGOMATIC, CHAMPION 120, CHAMPION 135,, CHAMPION 150, CHAMPION 160,, CHAMPION 180, CHAMPION 200,, CRONO 80, GRAND PRIX 75,, FORMULA 105, 1156, 1256 DT,, FORMULA 115, FORMULA 135,, FORMULA 135 DT, 1356 DT,, GRAND PRIX 874-90,, GRAND PRIX 95,, PLUS 55F, PLUS 70F, PLUS 75F,, PLUS 90F, PLUS 100F,, PREMIUM 1050DT, PREMIUM 1060DT, PREMIUM 1100, PREMIUM 1300,, PREMIUM 1600, PREMIUM 1800,, PREMIUM 850DT, R1106, R1306,, R1306, R1506, R2.100. R2.76,, R2.86, R2.90, R2.90 TARGET,, R3.105 TARGET, R3.90 TARGET,, R3.105, R3.85, R3.90, R3.95,, R3.95 TB, R4.105, R4.110,, R4.85, R4.95, R5.115, R5.130,, R5.140 EVO, R5.160 EVO,, RACING 150 DT, 1556,, RACING 165, RACING 190,, RACING 165, RACING 190, 674.70, RF100 TARGET, RF80.4 TARGET,, RF100, RF110, RF90, RS100,, RF90 TARGET, RF 80.4 TREND,, RS110, RS90, RV100, RV110,, SPIRE 85, SPRINT 674-70,, SPRINT 674-75, SPRINT 684-85,, TRACTION 240, TRACTION 265,, TRIUMPH 80/90/100, VICTORY 230, VICTORY 260,	2.9619.230.0, 2.9619.390.0, 2.9619.560.0, 2.9619.565.0, 2.9939.295.0

41132	12	2,1	10	LANDINI	5500, 5830, 5840, 5860, 5870, 6030, 6040, 6060, 6070, ADVANTAGE CAB E FOOT STEP :60, ADVANTAGE CAB E FOOT STEP:55, BLIZZARD :60, BLIZZARD:50, CINGOLATI: CF4830, CINGOLATI:C4500, CINGOLATI:C4830, CINGOLATI:C5000, CINGOLATI:C5500, CINGOLATI:C5830, CINGOLATI:CF5030, CINGOLATI:CF5830, CINGOLATI:CF6030, CINGOLATI:CF6060, FRUTTETI 530 F/L/V: 4530, FRUTTETI 530 F/L/V: 5530, FRUTTETI 530F/L/V:6030, FRUTTETI 560 F/L/V: 4560, FRUTTETI 560 F/L/V: 5560, FRUTTETI 560F/L/V :6060, GLOBUS:50, GLOBUS:55, NEW SERIE 60:5860, REX CAB E F.S: 60, TREKKER:CF55, TREKKER:CF60, VIGNETI CAB E FOOT STEP :55V, VIGNETI CAB E FOOT STEP :60V, VIGNETI REX CAB:60V, VIGNETI REX CAB:65V	3539389M91
LN3539389M91	12	2,1	10			3539389M91
38747	12	2,4	10			3541729M91
LN3541729M91	12	2,4	10			3541729M91
60273	12	2,6	10		BLIZZARD, FRUTTETO CABINATO, FRUTTETO FOOT-STEP, GLOBUS, GLOBUS 55, GLOBUS 55 TOP, GLOBUS RP30 - RP20, REX 60 F-L-V, REX 65 V, TREKKER, VIGNETO CABINATO, VIGNETO FOOT-STEP	3650746M91
ISKRAIS0520	12	2,7	10		50, 5560, 60, 6060,, ADVANTAGE 60, ADVANTAGE 65,, BLIZZARD, CF 5030, CF 5830,, CF 6060	3539389M91, 3542184M91, 3542184M92, 3546390M91
43032	12	2,8	10			3551773M91
41134	12	2,8	10		10000, 10000S, 12500, 12500 MOD., 13000, 13000 MOD., 14500, 5500, 5830, 6500, 6500(FINO A 1214500), 6550, 6560, 6830, 6840, 6860, 6870, 6880, 7000 SPECIAL, 7000/DT, 7000R, 7550, 7560, 7830, 7860, 7870, 7880, 8000/DT, 8000R, 8550, 8560, 8830, 8860, 8870, 8880, 9060, 9080, 9500, 9880, ADVANTAGE CAB E F.S: 65, ADVANTAGE CAB E F.S: 75, ADVANTAGE CAB E F.S:85, ADVANTAGE CAB:L95, ATLAS:100, ATLAS:70, ATLAS:75, ATLAS:80, ATLAS:85, ATLAS:90, BLIZZARD:65, BLIZZARD:75, BLIZZARD:85, BLIZZARD:95, C10500, C6500 (FINO A 1214500), C75, C85, C95, CF6830, CF75, CF85, CINGOLATI: C6830, CINGOLATI: C7800, CINGOLATI: C7830, CINGOLATI: C8860, CINGOLATI:6500, CINGOLATI:CF6830, FRUTTETI 530 F/L/V: 8530, FRUTTETI 530 F/L/V:6530, FRUTTETI 530 F/L/V:7530, FRUTTETI 560 F/L/V: 8560, FRUTTETI 560 F/L/V:6560, FRUTTETI 560 F/L/V:7560, GHIBLI:100, GHIBLI:80, GHIBLI:90, GLOBUS:65, GLOBUS:75, GLOBUS:80, LEGEND, MISTRAL:40, MYTHOS:100, MYTHOS:90, NEW SERIE 60:6860, NEW SERIE 60:7860, NEW SERIE 60:8860, NEW TREKKER :100C, NEW TREKKER :70C/F/L, NEW TREKKER :80C/F/L, NEW TREKKER :90 C/F/L, REX CAB:100, REX CAB:70, REX CAB:80, REX CAB:90, REX F.S: 100, REX F.S: 80, REX F.S: 90, REX F.S:70, TREKKER :C75, TREKKER :C85, TREKKER :C95, TREKKER :CF65, TREKKER :CF70, TREKKER :CF75, TREKKER :CF85, VIGNETI CAB E F.S:65V, VIGNETI CAB E F.S:75V, VIGNETI REX CAB :70V, VIGNETI REX CAB:80V, VISION:100, VISION:80, VISION:90	3539390M92, 3539395M1
LN3539390M92	12	2,8	10			3539390M92

Art./Ref.	Volt	Kw	N° denti/Teeth n°	Brand	Applicazione/Application	Rif. Orig./Orig. Ref.
<b>41213</b>	12	2,8	10	<b>LANDINI</b>	LARGE 16000, LARGE 16500	1618050M4
<b>60272</b>	12	2,8	10		BLIZZARD, FRUTTETO, FRUTTETO CABINATO, FRUTTETO FOOT-STEP, LEGEND 115 - 120 - 130 - 140, LEGEND 145 - 160 - 165 - 180, MINI, MYTHOS 110, SERIE 60 E 80, VIGNETO, VIGNETO CABINATO, VIGNETO FOOT-STEP	3648190M92
<b>93010</b>	12	2,8	10		10000S, 12500, 13000, 14500,, 65, 6560 F/L/V, 6860, 6880,, 75, 7560 F/L, 7860, 7880, 85,, 8560 F/L, 8860, 8880, 9080,, 95, 9880, C75, C85, C95,, CF6830, CF75, CF85	3542185M91, 3542185M92, 3546391M91
<b>ISKRAIS0509</b>	12	2,8	10			
<b>93004</b>	12	2,7	9	<b>MARELLI</b>		63217158, MSN232, MT71GB
<b>93006</b>	12	2,7	9			63217110, 63217173, MSN234, MT71L, MT71LA
<b>ISKRAIS0520</b>	12	2,7	10			63227470, 63227480, 63227488, MSN175, MSN184
<b>43032</b>	12	2,8	10			
<b>93010</b>	12	2,8	10			
<b>ISKRAIS0509</b>	12	2,8	10			54293280, 63216817, 63226323, 63226345, 63226405, 63226406, 63226410, 63227510, 63227515
<b>92940</b>	12	3	9			63217407, MT74G
<b>93009</b>	12	3,2	10			63280040, MSN8040
<b>41132</b>	2,1	12	10	<b>MASSEY FERGUSON</b>	135, 155, 158, 240, 250, 255, 340, 342, 350, 352, 355, MF35	3597426M3, 3597426R3
<b>ISKRAIS0520</b>	2,7	12	10		550, 5500, 6000, 81	3597371M2, 9643382M1
<b>41134</b>	2,8	12	10		1014, 1080, 1114, 1134, 1200, 1250, 165, 168, 174, 175, 178, 185, 188, 194, 265, 273, 274, 275, 283, 284, 285, 290, 293, 294, 298, 3050, 3060, 3065, 3070, 362, 365, 373, 374, 375, 377, 383, 384, 387, 390, 393, 394, 397, 398, 399, 4225, 4235, 4240, 4245, 4255, 4260, 4270, 565, 575, 590, 592, 595, 6110, 6120, 6130, 6140, 6150, 675, 690, 698, 699	3539390M91, 3539390M92, 3763362M91
<b>41138</b>	2,8	12	10		165, 355, 360, 560, 65, 765, MF 550	3763363M91, 3763363M92
<b>41213</b>	2,8	12	10		2620, 2625, 2640, 2645, 2680, 2685, 2720, 2725, 3080, 3090, 3610, 3630, 3650, MF2620	1618050M3, 1618050M4, 1618050R4, 1903145M91, 3637269R91
<b>43032</b>	2,8	12	10		130, 145, 2620, 2640, 2645, 2675, 2680, 2685, 2705, 2725, 3085 - 3095 - 3115 - 3125, 3645 - 3655, MF1004	1446802M91, 3581576M1, 3581576R1, 3630508R1, 3648191M92
<b>93010</b>	2,8	12	10		102, 105, 1080 S4RM, 1080,, 1085, 11, 1100, 1104, 1114,, 1250, 178, 186, 201, 205, 206,, 207, 30D, 3060, 3065, 307,, 3070, 487, 50 10TD/9TD, 50EX, 506, 510, 520, 525, 592, 595,, 6150, 620, 625, 675, 685, 690,, 9500, TX45	1447698M1, 1447731M1, 1447731R1, 1691806M1, 30281018
<b>ISKRAIS0509</b>	2,8	12	10			1691806R1, 1860093M2, 1868285R3, 1868287T, 3519400M92, 3597372M2, 3930506R1, 3930509R1
<b>91724</b>	3,2	12	10		290, 3425, 3435, 3445, 3455	26194600, 29194800
<b>93009</b>	3,2	12	10		8140, 8150, 8160, 8250, 8260,, 8270, 8280, SERIE 3600, 6270, 6280, 6290,	3784889M2, 3784890M1, 3823621M91
<b>26490</b>	12	2,7	9		<b>NEW HOLLAND</b>	55.85V-60.65M-55.65F-55.65M, 60.75V-60.65V-60.85F-55.85F, 62.85-55.65V-60.75M-55.85M, 62.85M-60.75-60.65-60.85V, L60-L65-L75-L85-L95, SB52 - SB54 BRAUD VENDEMMIATRI, TD55D - TD60D - TD65D, TD60 - TD70, TD65B, TD65F - TD75F - TD85F, TD70 - TD80 - TD90 - TD95, TD70-TD90-TD80-TD60-TD95, TD70D - TD75D, TK65V - TK70FA - 7TK70VA, TK75F - TK75FA, TK75M - TK75MA, TK75V - TK75VA, TL65A, TL65F-TL55F-TL75F, TL70-TL80-TL65-TL90-TL100, TN55 - TN55D - TN55S - TN55V, TN60A - TN60DA, TN60SA - TN60VA, TN65 - TN65D, TN65N - TN65S - TN65V, TN70 - TN70A - TN70D - TN70DA, TN70NA - TN70S, TN70SA - TN70VA, TN75 - TN75A - TN75D - TN75DA, TN75N - TN75NA, TN75S - TN75SA, TN75V - TN75VA, TT65D
<b>22046</b>	12	2,8	10	L781 - L783 - L785, TC52 - TC54 - TC56, TW5-10-15-25-35		83981923, D8NN11000CE
<b>26491</b>	12	3	9	70.75M-70.65M-80.75-80.65, 72.85-70.65-72.85M-, 88.85M-70.75-82.85M-80.66DT, L60-L65-L75-L85-L95, TD60-TD70-TD80-TD90-TD95, TD75D - TD80D - TD90D - TD95D, TK100A, TK80A - TK80MA, TK90A - TK90MA, TL55F-TL65F-TL75F, TL65-TL70-TL80-TL90-TL100, TL65A, TN75FA - TN85FA - TN95FA, TN95NA - TN95VA		4807375, 504059251

Art./Ref.	Volt	Kw	N° denti/Teeth n°	Brand	Applicazione/Application	Rif. Orig./Orig. Ref.
60275	12	3	10	NEW HOLLAND	555E - 575E - 655E - 675E, 75TLB - 85TLB - 95TLB, LB110, LB115 - LB115.B - LB115CP, LB75.B - LB85 - LB90 - LB95, TM115-125-150-165, TS100 - TS110 - TS115, TS80 - TS90, TS80-90-110-115, TV140	82007917, 87755550
91726	12	3,2	9		3500, 3550, 3750, 517 H/I/M,, 65-56, 65-66, 65-88, 65-90,, 70-56, 70-66 F/DT/ LP, 70-75,, 70-76V, 70-86 F/V, 70-88,, 70-90, 80-88, 82-86F, L517	2022506, 4169093, 4692478, 4699705, 4702248, 4737755, 4755109, 4763996, 4807375, 4832942, 87376493, 88205006, 9972215
91725	12	3,2	10		6610S, 6640, 7010, 7610S, 7740, 7840, 8010, 8160, 8240, 8260,, 8340, 8360, 8560, TB100, TB110, FARM 3430, FARM 3930,, FARM 4130, FARM 4630,, FARM 4830, FARM 4835,, FARM 5030, TC56, TC57, 5610S, TB120, TB80, TB85, TB90, TM115, TM125, TM135, TM150, TM165,, TS100, TS115, TV140,, TV140	82013134, 82014160, 82015723, 82021372, 84017265, 87318759, 87653221, 87755550

ORIGINALE

PK2873A101	12	2,2	13	PERKINS		
38747	12	2,4	10			2873121, 2873A010, 2873A102
43032	12	2,8	10		1004-4T, 4.440, 6.660, 1447732MI	1446802M91, 1447732R1, 2873A001, 2873A030, 2873A102, 2873B056, 2873B071, 3581576MI, 3581576R1, 37701400
93010	12	2,8	10		4.203LH, 6.354, A4.236, A4.248, A6.354.4, AT6.354.4, D3.152,, T4.236, T4.248	2873B057, 2873B057R, 2873B072, 2873B073, 2873D002
ISKRAIS0509	12	2,8	10			26410R, 2873B055, 2873B057, 2873B072
93009	12	3,2	10		1006-6T/TW, 1006-60T/TW/TA,, 1104D 44T, 1104D E44T,, 1104D E44TA, 1106C E60TA,, 1106D E66TA, SERIE 110, 1103C 33T,	2873K404, 2873K621, 2873K632
PK2873A102	12		10			
91724	12	3,2	10		1006-6T/TW, 1006-60T/TW/TA,, 1103D, 1104D, 854, A4.248,, T4.248	2873K405, 2873K624, 2873K625, 2873K626, 2873K634, 3586849, 3873K627, 527805

ORIGINALE

ISKRAIS0520	12	2,7	10	RENAULT		6005007548, 6005700082, 7701028780, 7701030289
93010	12	2,8	10		70-12SP, 70-14SP, 70-32, 70-34, 701-4F, 80-12, 80-14, 80-32,, 80-34, CERES 75, CERES 75X,	6005003154, 6005021274, 6005700081, 7700011850
ISKRAIS0509	12	2,8	10		50-12LB/V, 55-12F/LB/V,, 55-14LB/V, 70-12F/LB/V,, 70-14F/LB/V, 80-12F/V,, 80-14F/LB/V	6000102270, 6000102394, 6005003155, 6005003156
92940	12	3	9			
53287	12	3,1	9		CERES85-95, R351-421-456-460-461-462, R480-486-489-490-498, R50-51-53-551-556-56-60-61, R651-652	-
60268	12	3,1	10		ARES 610, ARES 620, ARES 630, ARES 640	7700044450, 7700045291

53285	12	3	9	SAME	ANTARES110,130,150, DORADO70, EXPLORER70,80,90, FRUTTETO75,85, GALAXY170, LASER110,130,150, SILVER80,90,100,90TURBO	2.9619.230.0, 2.9619.290.0/10, 2.9619.380.0, 2.9619.390.0, 2.9619.560.0
51732	12	3	9		ALSTER60, ANTARES110-130, BUFFALO130, CENTAURO70-EXPORT70, CONDOR55-CROP85-DRAGO120, EXPLORER55-65-65C-75-85, FRUTTETO60-75-2RM-75DT, GALAXY170-HERCULES160, JAGUAR95-100-105, LASER100,110-130-150-90, LEOPARD85-85EXPORT-90TURBO, LEOPARD90 TURBO C, MERCURY85-85EXPORT-85SPECIAL, MOMOTAIRIS60, PANTHER90-95, RANGER45-SOLAR60-TAURUS60-60C, SPECIAL CENTURION 75 SPECIAL, SPECIAL CENTURION55-70-75-75EX, TIGER100-SIX105-TITAN160, TITAN190-195, TRANSPORT85, VIGNERON50-60-70	2.9619.180.0, 2.9619.400.0, 2.9619.562.0
93008	12	4,2	9			
ISKRAIS1249	12	3,4	9		ANTARES 100, ANTARES 110,, ANTARES 130, ANTARESII 110DT,, ANTARESII 130, ARGON3 80,, DORADO 70, DORADO 75,, DORADO 76/86, DORADO 85,, DORADO3 100, DORADO3 90,, EXPLORER 100, EXPLORER 65C,, EXPLORER 70, EXPLORER 80,, EXPLORER 90, EXPLORER3 105,, EXPLORER3 90, EXPLORER4 105.4, FRUTTETO 80.4 CLASSIC,, FRUTTETOII 75DT,, FRUTTETOIII 90DT,, FRUTTETOIII 100,, FRUTTETOIII 110,, FRUTTETOIII 90,, GOLDEN 65, GOLDEN 75,, GOLDEN 85, GOLDEN 100,, KRYPTON 100, KRYPTON 80,, KRYPTON 90,, KRYPTON2 78 F/M/N/C,, KRYPTON2 88 F/M, KRYPTON3 100F, KRYPTON3 100N, KRYPTON3 110SIX, KRYPTON3 90C, KRYPTON3 90F,, LASER 110, LASER 130,, LASER 150, LASER 85, LASER 90,, LASER3 140, LASER3 160,, ROW CROP 90, RUBIN 150,, SILVER 100.4DT, SILVER 100.6DT, SILVER 105, SILVER 110,, SILVER 80DT, SILVER 85,, SILVER 90DT, SILVER 95,, SOLAR 60C, TITAN 145DT,, TITAN 160DT, TITAN 190DT,, VIGNERON 75DT	2.9619.230.0, 2.9619.390.0, 2.9619.560.0, 2.9619.565.0, 2.9939.295.0

Art./Ref.	Volt	Kw	N° denti/Teeth n°	Brand	Applicazione/Application	Rif. Orig./Orig. Ref.
<b>93004</b>	12	2,7	9	<b>STEYR</b>	30	
<b>53285</b>	12	3	9		8100, 8110, 8120, 8130, 8140, 8150, 8170	
<b>53286</b>	12	3	9		1100, 1108, 1200, 1400, 8140, 8150, 8160, 8165, 8170, 980, 988	
<b>51732</b>	12	3	11		1100, 1108, 1200, 288, 290, 406, 50, 650A, 658A, 760 SUPER, 760A, 768A, 988	
<b>41134</b>	12	2,8	10	<b>VALTRA</b>	255, 355, 365, 465, 504, 505, 565, 604, 605, 665, 800, 805, 865, 900, C100, C15, C20, C200	
<b>60256</b>	24	4	11		SK150	
<b>93006</b>	12	2,7	9	<b>VMMOTORI</b>	101M11, 101SU, 102MH11, 103M11, 103MH11, 103SV, 104M, 104M11,, 104MH11, 104SV, 1051M11,, 1051SV, 1051SU, 1052M11,, 1052SU, 1052SV, 1053M11,, 1053SV, 1054M11, 1054SV,, 1056M11, 106M, 106MH11, 112DAN, 112DAN/M, 113DAN, 113DAN/M,, 15DA, 195SV, 198SV, 20KVA,, 2105M, 24KVA, 25KVA, 295M9,5,, 295SV, 298M9,5, 298SV, 30KVA	
<b>93005</b>	12	2,7	11		492H9, 492H9, 492HT9, 492HTA, 494H, 494H10, 494HT, 494HT10,, 494HPT, 588HTT,, HR: 294HP, 394H, 394HP, 394HT,, RA: 392, 394	
<b>93007</b>	12	3	9		1056M11, 1056SU, 106MH11,, 106SU, 50KVA, 60KVA, 6105M/T, 70KVA, T1056SU	

**ALTERNATORI ADATTABILI**

ALTERNATEURS ADAPTABLE  
 ALTERNATORS ADAPTABLE  
 STROMWECHSLER PASSEND ZU  
 ALTERNADORES ADAPTABLE



Art./Ref.	Volt	Ampere	Brand	Applicazione/Application	Rif. Orig./Orig. Ref.
<b>21708</b>	12	33 con regolatore	<b>BOSCH</b>		0120339515, 0120339516, 0120339527, 0120339528, 0986030120, 0986030121
<b>93011</b>	12	35	<b>BOSCH</b>		9120331901, 9120331913, 9124476002, 9124476012, 9124476034
<b>93012</b>	12	35		0120339514, 0120339531, 0986030130, AL901X, AL905X	
<b>93013</b>	12	35		0120339512, 0120339513, 0120339532, 0120339544, 0120339545	
<b>41141</b>	12	45		0986031701, 9124476005, 9124476031	
<b>10786</b>	14	45 con regolatore		0120489337, 0986035760	
<b>41155</b>	14	55 con regolatore		0120489384	
<b>10788</b>	14	65 con regolatore		0120489153, 0120489212, 0120489219, 0120489338, 0986035630, 0986035631	
<b>59138</b>	12	90		0124325052	
<b>93012</b>	12	35	<b>CARRARO</b>	352, 354, 452, 454, 455CS, 502, 504, 505CL, 552, 554, 555CL,, 552, 554, 555CL, 652, 654,, 655CL, 702, 704, 9800	
<b>93012</b>	12	35	<b>DEUTZ</b>	D2807, D3607, D4506, D4507/C,, D4807/C, D5006, D5206, D5207/C, D6007/C, D6206, D6207/C,, D6507/C, D6806, D6807/C, D7007, D7206, D7207/C, D7807C, DX110,, DX120, DX3.60, DX50V, DX80,, DX85, DX86, DX90, DX92,, INTRAC 2002/2003/2004, M1080,, M1202, M980, M1002, M600, M660, M750, M770, M900, M922, M980	01163985, 01171617, 01177481
<b>93012</b>	12	35	<b>FENDT</b>	FARMER 200S/FL/V,, FARMER 203P/FL/V,, FARMER 204P/FL	X830060003000, X830060011

Art./Ref.	Volt	Ampere	Brand	Applicazione/Application	Rif. Orig./Orig. Ref.
<b>21708</b>	12	33 con regolatore	<b>FIAT</b>	45.66 - 45.66 DT, 45.76 V, 50.66 - 50.66 DT, 50.865 V - 50.865 V DT, 50.86V - 50.86V DT, 55.46 - 55.46 DT, 55.56 - 55.56 DT, 55.65 F-M-V, 55.66 - 55.66 DT, 55.66 LP - 55.66 LP DT, 55.66F - 55.66F DT, 55.66S - 55.66S DT, 55.66V - 55.66V DT, 55.75 F-M-V, 55.76F - 55.76F DT, 55.76V - 55.76V DT, 55.85 F-M-V, 60.46 - 60.46 DT, 60.56 DT, 60.65 M-V, 60.66 - 60.66 DT, 60.66F - 60.66F DT, 60.66LP - 60.66LP DT, 60.66S - 60.66S DT, 60.75 M-V, 60.76F - 60.76F DT, 60.85 F-V, 62.85 M, 62.86F - 62.86F DT, 65.46 - 65.46 DT, 65.66 - 65.66 DT, 65.66S - 65.66S DT, 70.56 - 70.56 DT, 70.65 M, 70.66 - 70.66 DT, 70.66V, 70.66F - 70.66F DT, 70.66LP - 70.66LP DT, 70.66S - 70.66S DT, 70.75 M, 70.76V, 70.76F - 70.76F DT, 70.76LP - 70.76LP DT, 72.85 - 72.85 M, 72.85 M, 80.65, 80.66 - 80.66 DT, 80.66F - 80.66F DT, 80.66S - 80.66S DT, 80.75, 80.76F - 80.76F DT, 80.88 - 80.88 DT, 82.85 M, 88.85 M, SERIE ORO	4762563, 4998353, 5101645, 9972269
<b>10782</b>	12	45 senza regolatore		FIAT SERIE ORO	4222697
<b>10786</b>	14	45 con regolatore		45.66 - 45.66 DT, 45.66S - 45.66S DT, 50.66 - 50.66 DT, 50.66S - 50.66S DT, 50.865 V - 50.865 V DT, 50.86V - 50.86V DT, 55.66 - 55.66 DT, 55.66S - 55.66S DT, 55.85 F-M-V, 55.88 - 55.88 DT, 55.90 - 55.90 DT, 56.66S - 56.66S DT, 60.56 DT, 60.66S - 60.66S DT, 60.85 F-V, 60.88 - 60.88 DT, 60.90 - 60.90 DT, 60.93 - 60.93 DT, 60.94 - 60.94 DT, 62.85 - 62.85 M, 62.86F - 62.86F DT, 65.66S - 65.66S DT, 65.88 - 65.88 DT, 65.90 - 65.90 DT, 65.93 - 65.93 DT, 65.94 - 65.94 DT, 70.56 - 70.56 DT, 70.66S - 70.66S DT, 70.88 - 70.88 DT, 70.90 - 70.90 DT, 72.85 - 72.85 M, 72.93 - 72.93 DT, 72.94 - 72.94 DT, 80.66S - 80.66S DT, 80.90 - 80.90 DT, 82.85 M, 82.93 - 82.93 DT, 82.94 - 82.94 DT, 85.55, 85.90 - 85.90 DT, 88.85 M, 88.93 - 88.93 DT, 88.94 - 88.94 DT, SERIE 66, SERIE 88, SERIE 90, SERIE 93, SERIE 94	4720502, 4787598, 4808498
<b>10788</b>	14	65 con regolatore		140.90, 160.90, 180.90, F100 - F100 DT, F110 - F110 DT, F115 - F115 DT, F120 - F120 DT, F130 - F130 DT, F140 - F140 DT	4808510, 4808511
<b>59138</b>	12	90			2855975

<b>21708</b>	12	33 con regolatore	<b>FORD</b>	3010S, 3435, 3830, 3935, 4010S, 4030, 4135, 4230, 4430, 5010S	4762563, 4998353, 5101645, 9972269
<b>10782</b>	12	45 senza regolatore		2310, 2600, 2910, 3000, 3600, 3910, 4000, 4100, 4610, 5600, 5610, 5700, 6600, 6700, 6710, 7000, 7810, 7910, 8210	83961474
<b>10786</b>	14	45 con regolatore		3435, 3830, 3935, 4030, 4135, 4230, 4430, 4635, 4835, 5635, 6635, 7635	4808498
<b>41155</b>	14	55 con regolatore		2310, 2600, 2910, 3600, 3910, 4000, 4100, 4610, 5600, 5610, 5700, 6600, 6700, 6710, 7000, 7810, 7910, 8210	83909615
<b>10788</b>	14	65 con regolatore		8430, 8630, 8830	4808511

Art./Ref.	Volt	Ampere	Brand	Applicazione/Application	Rif. Orig./Orig. Ref.
<b>93013</b>	12	35	<b>JOHN DEERE</b>	1020, 1120, 1130, 1530, 1830, 2020, 2030, 2040, 2120, 2130, 2140, 2150, 2255, 2350, 2840, 2940	AL32141, AL36100, AZ23314, AZ23575
<b>JDTY6748</b>	12	90		-	TY6748

Art./Ref.	Volt	Ampere	Brand	Applicazione/Application	Rif. Orig./Orig. Ref.
<b>93013</b>	12	35	<b>LAMBORGHINI</b>	483L/N, C362, C453, CS33,, R235S, R483, R513DT/V	
<b>10788</b>	14	65 con regolatore		AGILE 660, 775FPLUS, FORMULA 115, FORMULA 135, RACING 165, RACING 190	-

<b>41155</b>	14	55 con regolatore	<b>LANDINI</b>		-
--------------	----	-------------------	----------------	--	---

<b>21708</b>	12	33 con regolatore	<b>LAVERDA</b>	3400 - 3400R	4762563, 4998353, 5101645, 9972269
<b>10786</b>	14	45 con regolatore		3300 - 3300R, 3400 - 3400R, 3550AL, 3650 - 3650R, 3750 - 3750R	4808498
<b>10788</b>	14	65 con regolatore		3550AL - 3560AL, 3790 - 3790R, 3850 - 3850R, 3890 - 3890R, 8430, L518 - L520	4808511

<b>41141</b>	12	45	<b>NEW HOLLAND</b>		
<b>10786</b>	14	45 con regolatore		L60 - L65 - L75 - L85 - L95, SERIE L-TK-TL, TK65F - TK65V, TK75F - TK75M - TK75V, TK76 - TK76M, TK85 - TK85M, TK95M, TL65 - TL70 - TL80, TL90 - TL100	4808498
<b>59138</b>	12	90			504225814

Art./Ref.	Volt	Ampere	Brand	Applicazione/Application	Rif. Orig./Orig. Ref.
<b>41141</b>	12	45	<b>PERKINS</b>	MOTORI PERKINS 6.354.4, MOTORI PERKINS D3.1525, MOTORI PERKINS T6354.4	2871A120
<b>41155</b>	14	55 con regolatore		MOTORI PERKINS 4.236, MOTORI PERKINS 4.248, MOTORI PERKINS 6.354.1, MOTORI PERKINS T3.152	2871A141
<b>72988</b>	12	65		MOTORI TIPO SERIE 400-1100	185046500, 2871A301, 2873A301
<b>PK2871A163</b>	14	55		-	2871A163

<b>93011</b>	12	35	<b>RENAULT</b>	70-12SP, 70-14SP, 70-32, 70-34, 80-12SP, 80-14SP, 80-32, R5014	6005007750, 6005700083, 7700010614, 7700017032, 7701028801
--------------	----	----	----------------	--	--

<b>93013</b>	12	35	<b>SAME</b>	105.2LP, 982LP, AURORA 45,, CONDOR C, DELFINO 35, FALCON,, FOX35, FOX45, FOX55, RANGER 45, SIRENETTA, VIGNERON 35,, VIGNERON 45, VIGNERON 50,, VIGNERON 60	2.9439.030.0, 2.9439.070.0, 2.9439.170.0
<b>10788</b>	14	65 con regolatore		ANATARES 100, ANTARES 110,, ANTARES 130, FRUTTETO 75,, FRUTTETOII 60DT	-
<b>V2.9439.550.0</b>	14	55		-	2.9439.550.0

**RUOTE DENTATE ADATTABILI FIAT**
*ROUES DENTEES ADAPTABLE FIAT*
*RING GEAR ADAPTABLE FIAT*
*ZAHRAEDER PASSEND ZU FIAT*
*RUEDAS DENTADAS ADAPTABLE FIAT*

Art./Ref.	Note/Notes	Brand	Rif. Orig./Orig. Ref.
<b>10646</b>	Ruota dentata 110 denti IDM 325 mm/Gear wheel with 110 teeth, IDM 325 mm	<b>FIAT</b>	4602143
<b>19054</b>	Ruota dentata 128 denti IDM 372 mm/Ring gear teeth 128 IDM 372 mm	<b>FORD</b>	83949153, E2NN6384AA
<b>40185</b>	Ruota dentata 132 denti adatta a /Ring gear teeth 132 suitable: 2620-2640-2645-2685-2720-2725-3080-3085-3090-3095-3115-3120-3140-3160-3610-3630-3535-3645-3650-3655-3660-3670-3680-6170-6180-6190-8110-8120-8130-8140	<b>MASSEY FERGUSON</b>	0410236, 3552228M1, 731008M1



# 1.7.8 Guarnizioni e Paraolio

Gaskets and seals



## Ricambi & accessori per macchine agricole

SPARE PARTS & ACCESSORIES FOR AGRICULTURAL MACHINE

Tutti gli articoli della presente sezione, prodotti da AMA SPA e/o da terzi per conto di AMA, sono adattabili ("non originali") alle marche indicate ai sensi di quanto previsto dal REG. CE n. 1400/2002. I diritti sui marchi citati appartengono ai legittimi proprietari ed il loro uso ha l'esclusiva finalità di consentire all'utilizzatore la comparazione dei diversi prodotti. All items of this section, manufactured by AMA SPA and/or any third party on behalf of AMA, are adaptable ("non-original") to the brands listed under the provisions of the REG. CE n. 1400/2002. The rights on the trademarks belong to their respective owners and their usage is only aimed to allow the user to compare different products.

**CAPPELOTTI VALVOLA ADATTABILI MOTORI LOMBARDINI**

BOUCHONS SOUPAPE ADAPTABLE MOTEURS LOMBARDINI  
 VALVE CAPS ADAPTABLE LOMBARDINI ENGINES  
 VENTILKAPPE PASSEND ZU LOMBARDINI-MOTOREN  
 TAPAS VÁLVULA ADAPTABLE MOTORES LOMBARDINI

Art./Ref.	Brand	Applicazione/Application	Rif. Orig./Orig. Ref.
01184	LOMBARDINI	6LD360-325, LDA500-520-530, LDA904-914	2135.072
01186		3LD450-510, LDA450-510	2135.068
01188		4LD640-705-820, LDA96-97-100-820	2135.067
84374		5LD675/2-825/2-825/3, LDA672-832-833	2135.063



**ANELLI DI TENUTA TUBO ASTA PUNTERIE ADATTABILI LOMBARDINI**

BAGUES ADAPTABLE LOMBARDINI  
 RINGS ADAPTABLE LOMBARDINI  
 DICHTUNGSRINGE FÜR VENTILSTÖSSEL PASSEND ZU LOMBARDINI  
 ARANDELA DE COMPRESIÓN TUBO VÁSTAGO EMPUJADOR ADAPTABLE LOMBARDINI

Art./Ref.	Brand	Applicazione/Application	Rif. Orig./Orig. Ref.
01198	LOMBARDINI	LD GAD360-325 T/INFERIORE	4740.018
01199		3LD450,510-LDA450,510, 4LD640,705,820, LDA96,97,100,820-LA400	4740.017
01269		LDA672,673,674,832,833,834	1261.046
84375		LDA904-914	4740.022

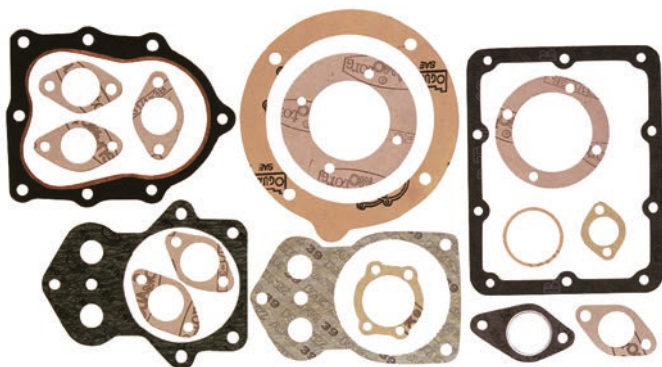

**SERIE GUARNIZIONI ADATTABILI MOTORI LOMBARDINI**

POCHETTE DE JOINTS ADAPTABLE MOTEURS LOMBARDINI  
 GASKET SET ADAPTABLE LOMBARDINI ENGINES  
 DICHTUNGSSÄTZE PASSEND ZU LOMBARDINI-MOTOREN  
 SERIE DE CRIBAS ADAPTABLE MOTORES LOMBARDINI

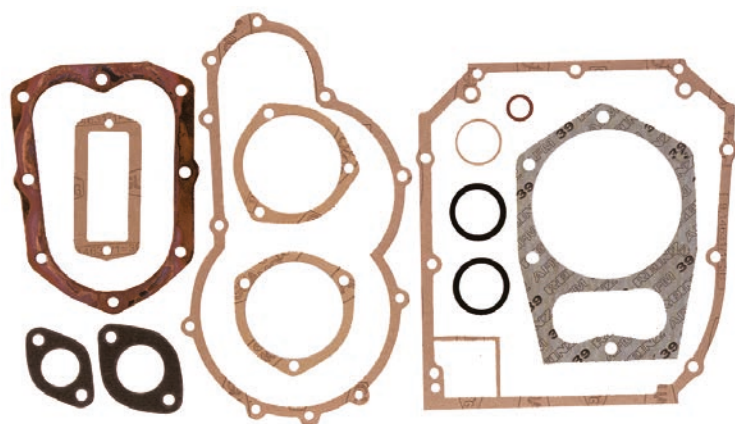

**Note:** \* = Serie motore completa di gommino tubo asta punteria e gommino cappello valvole. \*\* = Serie motore completa di gommino tubo asta punteria, gommino cappello valvole e o-ring.  
**Notes:** \* = Engine line, complete with rubber hose, push rod & inlet valve seal. \*\* = Engine line, complete with rubber hose, push rod, inlet valve seal & O-ring.

Art./Ref.	Note/Notes	Brand	Applicazione/Application	Rif. Orig./Orig. Ref.
01917	Serie motore */Engine line	LOMBARDINI	3LD450,510-LDA450,510	8185.001
08168	Serie motore */Engine line		LDA 672	8180.028
08217	Serie motore */Engine line		4LD705-LDA100	8180.027
08220	Serie motore */Engine line		3LD450,510-LDA450,510	8180.033
08224	Serie motore */Engine line		LDA 530	8180.055
08222	Serie smeriglio */Smeriglio line *		LDA672,673,674-D.95	8185.004
08223	Serie smeriglio */Smeriglio line *		LDA520-6LD325-D.78	8185.010
08225	Serie smeriglio */Smeriglio line **		LDA530-6LD360-D.82	8185.011

**GUARNIZIONI VARIE ADATTABILI MOTORI ACME**
*JOINTS ADAPTABLE MOTEURS ACME*
*SEALING ADAPTABLE ACME ENGINES*
*DICHTUNGEN PASSEND ZU ACME-MOTOREN*
*VARIAS CRIBAS ADAPTABLE MOTORES ACME*

Art./Ref.	Brand	Applicazione/Application	Rif. Orig./Orig. Ref.
08210	ACME	AL 480	A2336
08211		VT88-94	A2103
08212		ALN215-290-330	A2413

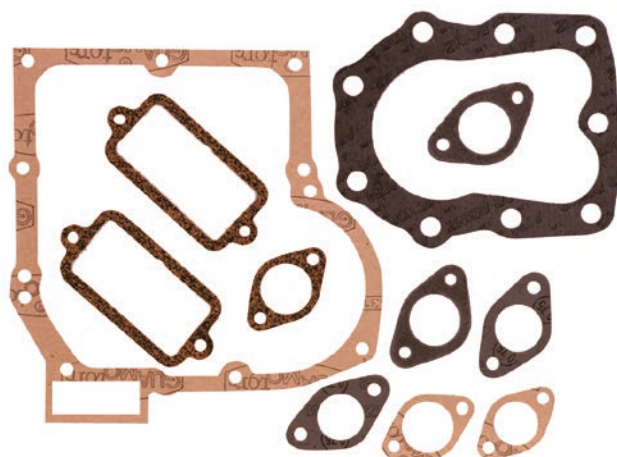
**GUARNIZIONI VARIE ADATTABILI MOTORI INTERMOTOR**
*JOINTS ADAPTABLE MOTEURS INTERMOTOR*
*GASKET SET ADAPTABLE INTERMOTOR ENGINES*
*DICHTUNGEN PASSEND ZU INTERMOTOR MOTOREN*
*VARIAS CRIBAS ADAPTABLE MOTORES INTERMOTOR*

Art./Ref.	Brand	Applicazione/Application	Rif. Orig./Orig. Ref.
08160	INTERMOTOR	IM300-301	8180.058, 8180.187
08161		IM350-351-352-252-302	8180.059, 8180.188

**ANELLI PARAOLIO ADATTABILI FIAT**

JOINT HUILE ADAPTABLE FIAT

OIL GASKET ADAPTABLE FIAT

ÖLDICHTUNGEN PASSEND ZU FIAT

JUNTA ADAPTABLE FIAT

Art./Ref.	Ø interno/ Inner Ø	Ø esterno/ Outside mm	Altezza mm/ Height mm	Note/Notes	Brand	Applicazione/Application	Rif. Orig./ Orig. Ref.	Immagine/Image
<b>08498</b>	56	70	8/10	Guarnizione tenuta olio del corpo differenziale / Oil gasket for differential Tipo - Type V4 173	<b>FIAT</b>	serie 90	40002710, 5105969, 5121471	
<b>14034</b>	45	65	15	Guarnizione tenuta olio del corpo differenziale tipo COMBI SF1 / Oil seal for differential adaptable to COMBI SF1		100.90, 115.90, 130.90, 140.90, 160.90, 180.90	40002580, 5105944, 5135990	
<b>14605</b>	40	62	10	Guarnizione tenuta olio del corpo tipo BASL/Oil gasket for differential type BASL/		SERIE 66, serie 90	27342232, 40002350, 4590419, 5105952, 5136002, 546690	
<b>08508</b>	45	65	10	Guarnizione tenuta olio per il cambio Tipo B1/Oil gasket for gearbox Adapt. To B1		55.46, 60.46, 60.56, 70.56, 640, 65.46	40000370, 40000371	
<b>15521</b>	50	68	8	Guarnizione tenuta per olio cambio Tipo B1KLRD /Oil gasket for gearbox type B1KLRD		100/90, 90/90	40003020, 5106069	
<b>14870</b>	25	31	7	Guarnizione tenuta olio per il cambio tipo BAOF/Oil gasket for gearbox type BAOF		SERIE 66, serie 88, serie 90	4985295	
<b>10666</b>	90	120	13	Guarnizione tenuta olio per semi-asse anteriore - Tipo COMBI /Oil seal for front semi-axle Adaptable to COMBI		SERIE 66, serie 88, serie 90	5116707, 5135387	
<b>14358</b>	42	62	17	Guarnizione tenuta olio per semi-asse anteriore Tipo COMBI / Oil gasket for front semi axle Type COMBI SF1		SERIE 66, serie 90	40002520, 5105923	

Art./Ref.	Ø interno/ Inner Ø	Ø esterno/ Outside mm	Altezza mm/ Height mm	Note/Notes	Brand	Applicazione/Application	Rif. Orig./ Orig. Ref.	Immagine/Image	
14917	55	70	8 LE	Guarnizione tenuta olio per corpo sollevatore Tipo BABS L /Oil gasket for lower link hydraulics Type BABS L	FIAT	100.90, 60/90, 70/90, 80/90, 90/90, SERIE 66, SERIE 76, serie 88	40002170, 5105903, 5159078		
26439	35	55	12 LE	Guarnizione tenuta olio per riduttori laterali Tipo B1/Oil gasket for reduction transmission Type B1		55.46 55.46DT, 60/46, 65/46	40000382, 40000384, 4951063		
10651	75	100	17	Guarnizione anteriore tenuta olio motore//Anterior motor oil seal					
14046				Guarnizione tenuta olio per alberi posteriori //Oil seal for back shafts					
14047								5106093, 5123259	
14048								5112302, 5126465	
08628								40001030	
26896								5125898	
28309							1355C, 1580ASP	1930371, 1940093	
16426							010.90-115.90-F100-F110-F115, F120	1930199, 1940058	
28295							750-805C*-850-850S-880	1909551, 1940077	
28297								1930863, 1940056	
12744								8281200	
28315								1930571, 1940022	
17169								5112285, 5112286, 5126464	
28066								79023162, 79065560	
15671								5108987	
15670							615, 615DT, 715	40000030, 40000032, 585219, 592289, 593522, 79102319	
26865							M100M115M135M160	5146367	
19022							TN55D-TN55S-TN65D-TN65S-TN65F, TN70D-TN70F-TN70S-TN75D-TN75, TN75S-TN80F-TN90F-TN95F	5125650	
19026						250-300	548274		
19018							5178141		
19020							5169122		

Art./Ref.	Ø interno/ Inner Ø	Ø esterno/ Outside mm	Altezza mm/ Height mm	Note/Notes	Brand	Applicazione/Application	Rif. Orig./ Orig. Ref.	Immagine/Image	
14647					FIAT		5112298, 5126466		
19025							40002330, 590851		
17158							79040176, 79070588		
14204							4606031, 4757006		
28812							5137563		
28063							5143775		
29143							5108639		
15227							40003414, 40101384		
29681							500300568, 585592, 591568		
27547							5150370		
28813							5137564		
19150							5140887		
14983							5113091, 5142486		
15565							5119206		
27546							5147372, 9959354		
15449							4957395, 4974705		
15640							9960227		
16418							5106350		
26902							1180, 1280, 1380, 1580, 1880	5107549	
27818							1180, 1280, 1380, 1580, 1880	5102151, 5128674	
15585							90.90DT-100.90DT- 110.90DT, TL70-TL80-TL90- TL100	4972381, 5148939, 562066	
19147							M100-M115-M135-M160	5136567	
27504							45.66-50.66-56.66S- 45.66S, 50.66S	567499	
27621								4631051, 4631052, 4813001	
19129								4973023, 567881	
15208								580484, 594758	
15206								588227	
14052								593754, 76008444, 79000642, 79007450, 79007594	
15201								581065	
15199								575824, 580485	
15217								4989627, 4989677, 584081, 79061079	
15200								580486	
19166								79071321, 8293408	
15204								586856	
27446								4607210	

Art./Ref.	Ø interno/ Inner Ø	Ø esterno/ Outside mm	Altezza mm/ Height mm	Note/Notes	Brand	Applicazione/Application	Rif. Orig./ Orig. Ref.	Immagine/Image
28052					FIAT		5112050	
19155							5149919	
28306						980-1000	1900425, 1909547, 1940039	
15722							79032657, 79051013, 79086720	
16427						110.90-115.90-F100-F110, 130.90-140.90, F115-F120	1930197, 1940059	
14516							4958992	
27545						115.90, 130.90, 140.90, 160.90, 1180, 1380, 1580, 1880, 180.90	5112025, 5124437	
14912						566, 666, 766, 5566S, 6066S, 8066S	5110478, 5153836, 8294816	
15534						1180, 1280, 1380, 1580, 1880	5109310	
16401R							79065571, 8291846	
N04769444							4769444	
N01940099							1940099	

14033	25	38			FORD	3435, 3830, 3935, 4030, 4135, 4230, 4430, 4635, 4835, 5635, 6635	47124792, 5121123	
14377	35	49		Anelli Paraolio//Oil gasket/		8160, 8260, 8360	5114000, 5131746	
14649	30	43,7		Anelli Paraolio/Oil Gasket		7635	5127037	
14034	45	65		Guarnizione tenuta olio del corpo differenziale tipo COMBI SF1 / Oil seal for differential adaptable to COMBI SF1				
21669						2000, 2310, 2600, 2810, 2910, 3000, 3600, 3900, 3055, 4100, 5000, 5600, 5700	83917464, DJPN6149S	

Art./Ref.	Ø interno/ Inner Ø	Ø esterno/ Outside mm	Altezza mm/ Height mm	Note/Notes	Brand	Applicazione/Application	Rif. Orig./ Orig. Ref.	Immagine/Image
21924					FORD	2000, 3000, 2310, 2600, 2610, 2810, 2910, 3055, 3600, 3900, 3230, 3430, 3610, 3910, 3930, 3900, 4100, 4000,, 4110, 4130, 4600, 4610, 4630, 550, 555, 555A/B	83926004, EAPN6A008A	
41626							1930960	
41627						8160, 8260, 8360, 8560, TM 115, 125, 135, 150, 165	1930959	
41559						4835	1940125	
41625						8670, 8770, 8870, 8970	82850515, F2NN6051AC	
41631R							87790152	
71099				Guarnizione tenuta olio per assale anteriore 4rm e 2rm//Oil seal for front axle 4wd and 2wd	LANDINI	ADVANTAGE CAB 55, 60, 65, 75, 85, 95 FRUTTETI 6560, 7560, 8560 REX CAB 60, 80, 100, 90 FO VIGNETI CAB 55V, 60V, 65V, 75V, 80V	3428124M1	
71112				Guarnizione tenuta olio per assale anteriore 4rm e 2rm//Oil seal for front axle 4wd and 2wd		ADVANTAGE CAB 60, 65, 75, 85, 95 FRUTTETI 6060, 6560, 7560, 8560 LEGEND 105, 115, 130, 145, 165	3542764M91	
40065	59	76	12,5	Guarnizione anteriore tenuta olio motore, con rivestimento metallico/Anterior motor oil seal with metallic cover		4000/DT, 4000R, 4500R		
40516						10000, 10000S, 3000R, 3000RV, 4000SPECIAL, 4530, 5530, 5830, 6030, 6830, 7530, 5000DT, 5000R-N, 5000R-S, 5000SPECIAL, 6000, 6000SPECIAL, 5840, 6040, 6840, 6505, 7505, 6550, 5500, 6500, 7500, 8500, 9500, 7000SPECIAL, 8000DT, 8000R, 7830, 8530, 8830, C10500, C4500, C4830, C5000, C5500, C5830, C6000, C6500, C7800	1446130M1, 2415216, 825374M1, 892563M1	
LN3429889M2				ORIGINALE/ORIGINAL			3429889M2	
LN3429791M1				ORIGINALE/ORIGINAL			3429791M1	
LN5157				ORIGINALE/ORIGINAL			U5157	



Art./Ref.	Ø interno/ Inner Ø	Ø esterno/ Outside mm	Altezza mm/ Height mm	Note/Notes	Brand	Applicazione/Application	Rif. Orig./ Orig. Ref.	Immagine/Image
40400					<b>MASSEY FERGUSON</b>		747447M91	
40398							4222946M91	
40408							747180M91	
40409							747448M91	
40354						65, 765	731011M2	
11720							3641182M1, 36812138, 744391M1	
40345						TEF20	61153	
41262						3095	3484317M92	
41263							3484624M91	

<b>08498</b>	56	70	8/10	Guarnizione tenuta olio del corpo differenziale - Oil gasket for differential Tipo - Type V4 173	<b>NEW HOLLAND</b>	SERIE L-M-F-TD-TL-TM-TS	5105969, 5121471	
<b>14034</b>	45	65	15	Guarnizione tenuta olio del corpo differenziale tipo COMBI SF1 /Oil seal for differential adaptable to COMBI SF1		F140, M135, M160, TM140	5135990	
<b>14605</b>	40	62	10	Guarnizione tenuta olio del corpo tipo BASL/Oil gasket for differential type BASL		SERIE L, SERIE TD, SERIE TL, SERIE TM, SERIE TS	5105952, 5136002	
<b>10666</b>	90	120	13	Guarnizione tenuta olio per semi-asse anteriore - Tipo COMBI //Oil seal for front semi-axle Adaptable to COMBI		SERIE L, SERIE TD, SERIE TL, SERIE TN	5116707, 5135387	
<b>14358</b>	42	62	17	Guarnizione tenuta olio per semi-asse anteriore Tipo COMBI / Oil gasket for front semi axle Type COMBI SF1		SERIE F, SERIE M, SERIE TD, SERIE TS	5105923	
<b>15521</b>	50	68	8	Guarnizione tenuta per olio cambio Tipo B1KLRD /Oil gasket for gearbox type B1KLRD		SERIE L, SERIE TL	5106069	
<b>14033</b>	25	38	-			L 60, L 65, L 75, L 85, L 95, TL 100, TL 70, TL 80, TL 90, TN 55, TN 65, TN 70, TN 75, TN 80 F, TN 90 F, TN 95 F	47124792, 5121123	
<b>14377</b>	35	49	-	Anelli Paraolio//Oil gasket		D110DT, D115 DT, F100 DT, F120, F130DT, F140DT, M100, M115, M135, TM115, TM120, TM125, TM130, TM140, TM140	5114000, 5131746	

Art./Ref.	Ø interno/ Inner Ø	Ø esterno mm/Outside Ø mm	Altezza mm/ Height mm	Note/Notes	Brand	Applicazione/Application	Rif. Orig./ Orig. Ref.	Immagine/Image
14649	30	43,7	-	Anelli Paraolio/Oil Gasket	<b>NEW HOLLAND</b>	L60 - L65, L65, L75, L85, L95, TL100, TL70, TL80, TL90	5127037, 5131746	
26414	-	-	-			TN70, TN75 NV	5125897	
NH5184116				Originale/Original			5184116	
NH5126466				Originale/Original			5126466	
NH5135989				Originale/Original			5135989	
NH5136002				Originale/Original			5136002	
NH195202C1				Originale/Original			195202C1	
NH1940056				Originale/Original			1940056	
NH1940040				Originale/Original			1940040	
NH1940002				Originale/Original			1940002	
NH1940053				Originale/Original			1940053	
NH1940027				Originale/Original			1940027	
NH1940051				Originale/Original			1940051	
NH1940092				Originale/Original			1940092	
NH1940047				Originale/Original			1940047	
NH1940060				Originale/Original			1940060	
NH1940076				Originale/Original			1940076	
NH1940034				Originale/Original			1940034	

40382				Adattabile/Adaptable	<b>PERKINS</b>		106387	
40402				Adattabile/Adaptable			U5LB0046	
40066				Adattabile/Adaptable			2415361	
PK2418F436				Originale/Original			2418F436	
PK36883119				Originale/Original			36883119	
PK2415344				Originale/Original			2415344	
PK34157				Originale/Original			34157	
PK2418F432				Originale/Original			2418F432	
PKU5LB1157				Originale/Original			U5LB1157	
PKU5LT5138				Originale/Original			U5LT5138	
PKU5LT1004				Originale/Original			U5LT1004	
PKU5LT1002				Originale/Original			U5LT1002	
PKU5LT1190				Originale/Original			U5LT1190	
PKU5LT1202				Originale/Original			U5LT1202	
PKU5LT1181				Originale/Original			U5LT1181	
PKU5LT1179				Originale/Original			U5LT1179	
PKU5LT0512				Originale/Original			U5LT0512	
PKU5LT1014				Originale/Original			U5LT1014	
PKU5LT1138				Originale/Original			U5LT1138	
PK2418F475				Originale/Original			2418F475	
PK2418F704				Originale/Original			2418F704	

28380				Adattabile/Adaptable	<b>SAME</b>		0.006.1869.6	
28381				Adattabile/Adaptable			0.006.1870.6	
V0.275.6353.4				Originale/Original			0.275.6353.4	
V0.445.0020.6				Originale/Original			0.445.0020.6	
V0.009.4329.2				Originale/Original			0.009.4329.2	
V0.97626.71.4				Originale/Original			0.97626.71.4	
V2.1569.109.0				Originale/Original			2.1569.109.0	
V0.007.1445.0				Originale/Original			0.007.1445.0	
V2.1539.178.0				Originale/Original			2.1539.178.0	
V2.1529.141.0				Originale/Original			2.1529.141.0	
V2.1529.130.0				Originale/Original			2.1529.130.0	
V2.1529.120.0				Originale/Original			2.1529.120.0	
V2.1529.058.0/1				Originale/Original			2.1529.058.0/10	
V2.1529.038.0				Originale/Original			2.1529.038.0	
V2.1519.096.0/2				Originale/Original			2.1519.096.0/20	

# 1.7.9 Strumenti parti elettriche

Tools, electrical parts



## Ricambi & accessori per macchine agricole

SPARE PARTS & ACCESSORIES FOR AGRICULTURAL MACHINE

Tutti gli articoli della presente sezione, prodotti da AMA SPA e/o da terzi per conto di AMA, sono adattabili ("non originali") alle marche indicate ai sensi di quanto previsto dal REG. CE n. 1400/2002. I diritti sui marchi citati appartengono ai legittimi proprietari ed il loro uso ha l'esclusiva finalità di consentire all'utilizzatore la comparazione dei diversi prodotti. All items of this section, manufactured by AMA SPA and/or any third party on behalf of AMA, are adaptable ("non-original") to the brands listed under the provisions of the REG. CE n. 1400/2002. The rights on the trademarks belong to their respective owners and their usage is only aimed to allow the user to compare different products.

**QUADRO STRUMENTO ADATTABILE FIAT**

TABLEAU DE BORD ADAPTABLE FIAT  
 INSTRUMENT PANEL ADAPTABLE FIAT  
 INSTRUM.TAFEL PASSEND ZU FIAT  
 PANEL DE INSTRUMENTOS ADAPTABLE FIAT



Art./Ref.	Brand	Applicazione/Application	Rif. Orig./Orig. Ref.
<b>10619</b>	<b>FIAT</b>	450, 480, 500, 540, 550, 600, 640, CINGOLATI SERIE ORO	4334915, 4335525

**INDICATORE TEMPERATURA ACQUA ADATTABILE**

TEMPERATURE EAU ADAPTABLE  
 WATER TEMPERATURE GAUGE ADAPTABLE  
 KÜHLWASSERANZEIGE PASSEND ZU  
 MEDIDOR DE TEMPERATURA DEL AGUA ADAPTABLE



Art./Ref.	Brand	Applicazione/Application	Rif. Orig./Orig. Ref.
<b>41964</b>	<b>FIAT</b>	450, 480, 500, 540, 550, 600, 640, CINGOLATI SERIE ORO	4334917

<b>41964</b>	<b>LANDINI</b>	10000, 12500, 13000, 14500, 5500, 5830( DA 221R03297), 5830( FINO A 221R03296), 5840, 6030, 6040, 6500, 6550, 6830(DA 221S04456), 6830(FINO A 221S04455), 6840, 7500, 7550, 7830( DA 220L01505), 7830(FINO A 220L01504), 8500, 8550, 8830( DA 223H02262), 8830(FINO A 223H02261), ATLAS:100, ATLAS:70, ATLAS:75, ATLAS:80, ATLAS:85, ATLAS:90, CINGOLATI:C4500, CINGOLATI:C4830, CINGOLATI:C5500, CINGOLATI:C5830, CINGOLATI:C6500, CINGOLATI:C6830, CINGOLATI:C7800, CINGOLATI:C7830, CINGOLATI:C8860, CINGOLATI:CF4830, CINGOLATI:CF5030, CINGOLATI:CF5830, CINGOLATI:CF6030, CINGOLATI:CF6060, CINGOLATI:CF6830, FRUTTETI 530 F/L:5530F/L, FRUTTETI 530 F/L:6530F/L, FRUTTETI 530 F/L:7530F/L, FRUTTETI 530 F/L:8530L, FRUTTETI 530F:8530F, FRUTTETI 530V:4530V, FRUTTETI 530V:5530V, FRUTTETI 530V:6030F/L/V, FRUTTETI 530V:6530V, REX CAB E F.S: 100, REX CAB E F.S: 60, REX CAB E F.S: 70, REX CAB E F.S: 90, REX CAB E F.S:80, VIGNETI REX CAB:60V, VIGNETI REX CAB:65V, VIGNETI REX CAB:70V, VIGNETI REX CAB:80V	3305408M93, 3654640M91
--------------	----------------	--	------------------------

<b>41964</b>	<b>MASSEY FERGUSON</b>	1004 T, 1014 - 1024 - 1114 - 1134, 134 V, 154 F, 154 S, 154 V, 164 T F, 164 T S, 164 T V, 174 F, 174 S, 174 V, 184 F, 184 S, 194 F, 194 S, 233, 234 CF, 244 CF, 253, 254 CF, 263 T, 264 T, 264 T CF, 264 T S, 273, 274 C, 274 CF, 274 SK, 283, 284, 293, 294, 294 C, 294 S, 364 CF, 394 C, 675, 690, 698, 698 T, 699	3305408M91, 3305408M92, 3305408M93
--------------	------------------------	--	------------------------------------

**CONTAORE-CONTAGIRI ADATTABILE FIAT**

COMPTE-HEURE ADAPTABLE FIAT  
 COUNTER ADAPTABLE FIAT  
 DREHZAHLMESSER PASSEND ZU FIAT  
 NÚMERO DE HORAS ADAPTABLE FIAT



Art./Ref.	Brand	Applicazione/Application	Rif. Orig./Orig. Ref.
10676	FIAT	450, 480, 500, 540, 550, 600, 640, CINGOLATI SERIE ORO	4180290, 4328998, 4334916

**CONTAORE-CONTAGIRI ADATTABILE MASSEY FERGUSON**

COMPTE-HEURE ADAPTABLE MASSEY FERGUSON  
 COUNTER ADAPTABLE MASSEY MASSEY FERGUSON  
 DREHZAHLMESSER PASSEND ZU MASSEY FERGUSON  
 NÚMERO DE HORAS ADAPTABLE MASSEY FERGUSON

Art./Ref.	Brand	Applicazione/Application	Rif. Orig./Orig. Ref.	Immagine/Image	
41934	MASSEY FERGUSON	165, 168, 175, 178, 185, 188	898489M91		
41930		165, 175, 178	898485M91		
41917		FE35	1850093M93		
41921		35	894428M91		
41938		2725	3381409M1		
41931		155, 158, 165, 168, 185, 188	1860065M91, 908473M1		
41916		FE35	1850092M93		
<b>ORIGINAL</b> LN979061M91				979061M91	

**INDICATORE CARBURANTE ADATTABILE FIAT**

INDICATEUR NIVEAU CARBURANT ADAPTABLE FIAT  
 FUEL GAUGE ADAPTABLE FIAT  
 KRAFTSTOFFANZEIGER PASSEND ZU FIAT  
 MEDIDOR DE COMBUSTIBLE ADAPTABLE FIAT

Art./Ref.	Brand	Rif. Orig./Orig. Ref.
<b>10624</b>	<b>FIAT</b>	4180589, 4243893, 4998701, 5199933
<b>NH5150091</b>	<b>NEW HOLLAND</b>	5150091
<b>NH5136770</b>		5136770

ORIGINALE  
 ORIGINALE

**QUADRO STRUMENTO ADATTABILE**

TABLEAU DE BORD ADAPTABLE  
 INSTRUMENT PANEL ADAPTABLE  
 INSTRUM.TAFEL TYP PASSEND ZU  
 PANEL DE INSTRUMENTOS ADAPTABLE



Art./Ref.	Brand	Applicazione/Application	Rif. Orig./Orig. Ref.
<b>10620</b>	<b>FIAT</b>	45-66S, 45-66S - 45-66S DT, 50-66S - 50-66S DT, 50-86 V - 50-86 V DT, 50-86S V - 50-86S V DT, 55-56 - 55-56 DT, 55-66S - 55-66S DT, 55-86 F - 55-86 F DT, 55-86 V - 55-86 V DT, 55-86S V - 55-86S V DT, 56-66S - 56-66S DT, 60-56 DT, 60-66S - 60-66S DT, 60-86 F - 60-86 F DT, 60-86 V - 60-86 V DT, 60-86S V - 60-86S V DT, 62-86 F - 62-86 F DT, 65-56 - 65-56 DT, 65-66S - 65-66S DT, 70-56 - 70-56 DT, 70-66S - 70-66S DT, 70-86 V - 70-86 V DT, 70-86S V - 70-86S V DT, 72-86 F - 72-86 F DT, 72-86 LP - 72-86 LP DT, 82-86 F - 82-86 F DT, 82-86 LP - 82-86 LP DT	4997124, 5105878, 5133783, 5145186
<b>NO4334915</b>		455C, 640	4334915
<b>NH5192077R</b>	<b>NEW HOLLAND</b>	TN55S SUPERSTEER,, TN65D DE LUXE, TN65S SUPERSTEER, TN75S SUPERSTEER, TNF	5192077
<b>10620</b>	<b>FORD</b>	3435, 3830, 3935, 4030, 4135, 4230, 4430	5145186

ORIGINALE

**STRUMENTAZIONE VARIA ORIGINALE SAME**

INSTRUMENTATION DIVERS ORIGINAL SAME  
 VARIOUS INSTRUMENTATION SAME ORIGINAL  
 VERSCHIEDENE INSTRUMENTATION ORIGINAL SAME  
 VARIAS INSTRUMENTACIONES ORIGINAL SAME

Art./Ref.	Descrizione/Description	Brand	Rif. Orig./Orig. Ref.
<b>V2.7059.950.0/1</b>	Indicatore carburante	<b>SAME</b>	2.7059.950.0/10
<b>V9.62081.50.0</b>	Kit galleggiante	<b>SAME</b>	9.62081.50.0
<b>V2.8339.248.0/7</b>	Strumento digitale	<b>SAME</b>	2.8339.248.0/7

# 1.7.10 Cingolature

Track chain



## Ricambi & accessori per macchine agricole

SPARE PARTS & ACCESSORIES FOR AGRICULTURAL MACHINE

Tutti gli articoli della presente sezione, prodotti da AMA SPA e/o da terzi per conto di AMA, sono adattabili ("non originali") alle marche indicate ai sensi di quanto previsto dal REG. CE n. 1400/2002. I diritti sui marchi citati appartengono ai legittimi proprietari ed il loro uso ha l'esclusiva finalità di consentire all'utilizzatore la comparazione dei diversi prodotti. All items of this section, manufactured by AMA SPA and/or any third party on behalf of AMA, are adaptable ("non-original") to the brands listed under the provisions of the REG. CE n. 1400/2002. The rights on the trademarks belong to their respective owners and their usage is only aimed to allow the user to compare different products.

**CINGOLATURE CON PASSO CATENE DA 125 MM ADATTABILI FIAT**
*PISTES AVEC CHAINES PITCH 125 MM ADAPTABLE FIAT*
*TRACKS WITH PITCH CHAINS 125 MM ADAPTABLE FIAT*
*TRACKS MIT PITCH CHAINS 125 MM PASSEND ZU FIAT*
*LAS PISTAS CON CADENA DE PASO 125 MM ADAPTABLE FIAT*

Art./Ref.	Passo/Pitch	Maglie/Links	Note/Notes	Brand	Applicazione/Application	Rif. Orig./Orig. Ref.	Immagine/Image
<b>18209</b>	125	33	Catena passo 125 mm da 33 maglie - Chain pitch 125 mm 33 links - Ref. Berco FT1335/33	<b>FIAT</b>	25C-25CI-25CS-25CSI, 311-311C-311CI, 312-312C, 322-322C, 331C-331CI, 332-332C, 351-351C, 352-352C, 355-355MONTAGNA-355F, AD3	557115	
<b>14167</b>	125	34	Catena passo 125 mm da 34 maglie - Chain pitch 125 mm 34 links - Ref. Berco FT1335/34		355C-355 C MONTAGNA, 455C-455C SUPER-455CF, 455CM-455CMS	4960993	
<b>15943</b>	125	35	Catena passo 125 mm da 35 maglie - Chain pitch 125 mm 35 links - Ref. Berco FT1335/35		465C-465CF FRUTTEO, 465CM MONTAGNA-465CV VIGNETO, 55.65, 55.65FRUTTETO, 55.65MONTAGNA, 55.65VIGNETO, 55.75, 55.75FRUTTETO, 55.75MONTAGNA, 55.75VIGNETO, 55.85, 55.85FRUTTETO, 55.85MONTAGNA, 55.85VIGNETO, 60.65VIGNETO, 60.75VIGNETO, 60.85FRUTTETO, 60.85VIGNETO	5114442, 5193415	
<b>14165</b>	125	-	Rullo Cpt.1B con boccola / Tracking Cpt.1B with bushing - Ref. Berco FT3541		355 MONTAGNA, 355C-355C MONTAGNA, 455 SECOND TYPE, 455C SECOND TYPE, 455C SUPER, 455CF-455CM-455CMS-, 465-465C, 465CF FRUTTETO, 465CM MONTAGNA, 465CV VIGNETO, 55.65 FRUTTETO, 55.65 MONTAGNA, 55.65 VIGNETO, 55.75 FRUTTETO, 55.75 MONTAGNA, 55.75 VIGNETO, 55.85 FRUTTETO, 55.85 MONTAGNA, 55.85 VIGNETO, 60.65 VIGNETO, 60.75 VIGNETO, 60.85 FRUTTETO, 60.85 VIGNETO	4968573, 5173247, 5193323	
<b>83165</b>	125	-	Rullo Cpt.2B con boccola / Tracking Cpt.2B with bushing - Ref. Berco FT3580		-	-	
<b>14170</b>	125	-	Suola a 1 costa da 250 mm - Shoe 1 grouser 250 mm - Ref. Berco FT1238		311C-311CI, 312C, 351C, 352C, 355 MONTAGNA-355C MONTAGNA, 355F, 455C SECOND TYPE, 455C SUPER, 455CF, 465CV VIGNETO, 55.65 VIGNETO, 55.75 VIGNETO, 55.85 VIGNETO, 60.65 VIGNETO, 60.75 VIGNETO, 60.85 VIGNETO, AD3	5193416, 558435	
<b>84394</b>	125	-	Suola a 1 costa da 280 mm - Shoe 1 grouser 280 mm - Ref. Berco FT1238/280		465CF FRUTTETO, 55.65 FRUTTETO, 55.75 FRUTTETO	5127837	
<b>16488</b>	125	-	Suola a 1 costa da 300 mm - Shoe 1 grouser 300 mm - Ref. Berco FT1238/300		455CM MONTAGNA, 465C, 465CM MONTAGNA, 55.65 MONTAGNA, 55.75 MONTAGNA, 55.85 MONTAGNA	4960799, 5193417, 560860	
<b>84395</b>	125	-	Suola a 1 costa da 310 mm - Shoe 1 grouser 310 mm - Ref. Berco FT1238/310		455 SECOND TYPE		
<b>16487</b>	125	-	Ruota Motrice - Sprocket - Ref. Berco FT667		311C, 312-312C, 351-351C, 352C, 355-355 MONTAGNA, 355C MONTAGNA, 455C SECOND TYPE, 455C SUPER, 455CM, AD3	4958366, 568070	
<b>16492</b>	125	-	Ruota Motrice - Sprocket - Ref. Berco FT2289	55.65F, 55.75F, 55.85F, 55.85M, 55.85V, 60.85F, 60.85V	5129972		
<b>18207</b>	125	-	Ruota Motrice - Sprocket - Ref. Berco FT2290	55.65M, 55.65V, 55.75M, 55.75V, 55.85F, 55.85M, 55.85V, 60.65, 60.65M, 60.65V, 60.75, 60.75M, 60.75V, 60.85F, 60.85V	5112858, 5129967		



**CINGOLATURE CON PASSO CATENE DA 125 MM ADATTABILI LAMBORGHINI**

PISTES AVEC CHAINES PITCH 125 MM ADAPTABLE LAMBORGHINI  
 TRACKS WITH PITCH CHAINS 125 MM ADAPTABLE LAMBORGHINI  
 TRACKS MIT PITCH CHAINS 125 MM PASSEND ZU LAMBORGHINI  
 LAS PISTAS CON CADENA DE PASO 125 MM ADAPTABLE LAMBORGHINI



Art./Ref.	Passo/Pitch	Maglie/Links	Note/Notes	Brand	Applicazione/Application	Rif. Orig./Orig. Ref.	Immagine/Image
18209	125	33	Catena passo 125 mm da 33 maglie - Chain pitch 125 mm 33 links - Ref. Berco FT1335/33	LAMBORGHINI	C340-C340L-C340LL-C340CS	-	
15943	125	35	Catena passo 125 mm da 35 maglie - Chain pitch 125 mm 35 links - Ref. Berco FT1335/35		C350-C350L, C483-C483L, C533N-C554	0.007.8939.4, 0.007.8939.4/10	
14165	125	-	Rullo Cpt.1B con boccola / Tracking Cpt.1B with bushing - Ref. Berco FT3541		1C/CTC/CTL, C226, C230L/LL/S, C235L/LL/S, C340-C340L-C340LL-C340CS, C350-C350L, C352L/S/LS, C362S, C483-C483L, C533N, C554	0.007.8856.4/10	



**CINGOLATURE CON PASSO CATENE DA 125 MM ADATTABILI LANDINI**

PISTES AVEC CHAINES PITCH 125 MM ADAPTABLE LANDINI  
 TRACKS WITH PITCH CHAINS 125 MM ADAPTABLE LANDINI  
 TRACKS MIT PITCH CHAINS 125 MM PASSEND ZU LANDINI  
 LAS PISTAS CON CADENA DE PASO 125 MM ADAPTABLE LANDINI





Art./Ref.	Passo/Pitch	Maglie/Links	Note/Notes	Brand	Applicazione/Application	Rif. Orig./Orig. Ref.	Immagine/Image
18209	125	33	Catena passo 125 mm da 33 maglie - Chain pitch 125 mm 33 links - Ref. Berco FT1335/33	LANDINI	C35-CL35-CS35, C4000-CL4000-CS4000	976142M93	
15943	125	35	Catena passo 125 mm da 35 maglie - Chain pitch 125 mm 35 links - Ref. Berco FT1335/35		4500-4500M-4500S, 4830-4830C-4830CL MONTAGNA, 4830CS, TREKKER 55F LARGO E STRETTO	1825109M1, 3539041M93, 4205513M91	
14165	125	-	Rullo Cpt.1B con boccola / Tracking Cpt.1B with bushing - Ref. Berco FT3541		4500M-4500S, 4830C-4830CL MONTAGNA-4830CS, TREKKER 55F LARGO, TREKKER 55F STRETTO, TREKKER 60F, TREKKER 60F LARGO, TREKKER 60F STRETTO	-	
14170	125	-	Suola a 1 costa da 250 mm - Shoe 1 grouser 250 mm - Ref. Berco FT1238/250		4500S, 4830CS, C3200 3 ROLLERS, C3200 4 ROLLERS, C4000, CL35, TREKKER 55F STRETTO, TREKKER 60F STRETTO	1816941M1	
84394	125	-	Suola a 1 costa da 280 mm - Shoe 1 grouser 280 mm - Ref. Berco FT1238/280		4500, 4830-4830C, C35, CL3200 3 ROLLERS, CL3200 4 ROLLERS, CL4000, TREKKER 60, TREKKER 60F	978780M1	
84395	125	-	Suola a 1 costa da 310 mm - Shoe 1 grouser 310 mm - Ref. Berco FT1238/310		4500M, 4830CL MONTAGNA, TREKKER 55F LARGO, TREKKER 60F LARGO	1816331M1	

**CINGOLATURE CON PASSO CATENE DA 125 MM ADATTABILI MASSEY FERGUSON**
*PISTES AVEC CHAINES PITCH 125 MM ADAPTABLE MASSEY FERGUSON*
*TRACKS WITH PITCH CHAINS 125 MM ADAPTABLE MASSEY FERGUSON*
*TRACKS MIT PITCH CHAINS 125 MM PASSEND ZU MASSEY FERGUSON*
*LAS PISTAS CON CADENA DE PASO 125 MM ADAPTABLE MASSEY FERGUSON*

Art./Ref.	Passo/Pitch	Maglie/Links	Note/Notes	Brand	Applicazione/Application	Rif. Orig./Orig. Ref.	Immagine/Image
<b>15943</b>	125	35	Catena passo 125 mm da 35 maglie - Chain pitch 125 mm 35 links - Ref. Berco FT1335/35	<b>MASSEY FERGUSON</b>	MF134-MF134C-MF134CL-MF134CS, MF234-MF234C-MF234CF-MF234CL, MF234CS	3539041M93	
<b>14165</b>	125	-	Rullo Cpt.1B con boccola / Tracking Cpt.1B with bushing - Ref. Berco FT35411	-	MF134C-MF134CL-MF134CS, MF234C-MF234CF-MF234CL-MF234CS	-	
<b>14170</b>	125	-	Suola a 1 costa da 250 mm - Shoe 1 grouser 250 mm - Ref. Berco FT1238/250	-	MF114C-MF114CS, MF124-MF124CS, MF134-MF134CS, MF234-MF234CS	1816941M1	
<b>84394</b>	125	-	Suola a 1 costa da 280 mm - Shoe 1 grouser 280 mm - Ref. Berco FT1238/280	-	MF114CL, MF124-MF124C, MF134-MF134C, MF234-MF234CF	978780M1	
<b>84395</b>	125	-	Suola a 1 costa da 310 mm - Shoe 1 grouser 310 mm - Ref. Berco FT1238/310	-	MF124CL, MF134-MF134CL, MF234-MF234CL	1816331M1	

**CINGOLATURE CON PASSO CATENE DA 125 MM ADATTABILI SAME**
*PISTES AVEC CHAINES PITCH 125 MM ADAPTABLE SAME*
*TRACKS WITH PITCH CHAINS 125 MM ADAPTABLE SAME*
*TRACKS MIT PITCH CHAINS 125 MM PASSEND ZU SAME*
*LAS PISTAS CON CADENA DE PASO 125 MM ADAPTABLE SAME*

Art./Ref.	Passo/Pitch	Maglie/Links	Note/Notes	Brand	Applicazione/Application	Rif. Orig./Orig. Ref.	Immagine/Image
<b>14167</b>	125	34	Catena passo 125 mm da 34 maglie - Chain pitch 125 mm 34 links - Ref. Berco FT1335/34	<b>SAME</b>	CONDOR C, FALCON C	-	
<b>15943</b>	125	35	Catena passo 125 mm da 35 maglie - Chain pitch 125 mm 35 links - Ref. Berco FT1335/35		SOLAR 55C	0.007.8939.4, 0.007.8939.4/10	
<b>14165</b>	125	-	Rullo Cpt.1B con boccola / Tracking Cpt.1B with bushing - Ref. Berco FT3541		CONDOR C, FALCON C, FOX 35-45-55, SOLAR 55C	0.007.8856.4/10	
<b>84394</b>	125	-	Suola a 1 costa da 280 mm - Shoe 1 grouser 280 mm - Ref. Berco FT1238/280		-	0.431.9450.0	
<b>16488</b>	125	-	Suola a 1 costa da 300 mm - Shoe 1 grouser 300 mm - Ref. Berco FT1238/300		-	0.168.9411.0/10	

**CINGOLATURE CON PASSO CATENE DA 125 MM ADATTABILI NEW HOLLAND**

PISTES AVEC CHAINES PITCH 125 MM ADAPTABLE NEW HOLLAND  
 TRACKS WITH PITCH CHAINS 125 MM ADAPTABLE NEW HOLLAND  
 TRACKS MIT PITCH CHAINS 125 MM PASSEND ZU NEW HOLLAND  
 LAS PISTAS CON CADENA DE PASO 125 MM ADAPTABLE NEW HOLLAND



Art./Ref.	Passo/Pitch	Maglie/Links	Note/Notes	Brand	Applicazione/Application	Rif. Orig./Orig. Ref.	Immagine/Image
18209	125	33	Catena passo 125 mm da 33 maglie - Chain pitch 125 mm 33 links - Ref. Berco FT1335/33	NEW HOLLAND	-	-	
14167	125	34	Catena passo 125 mm da 34 maglie - Chain pitch 125 mm 34 links - Ref. Berco FT1335/34		-	-	
15943	125	35	Catena passo 125 mm da 35 maglie - Chain pitch 125 mm 35 links - Ref. Berco FT1335/35		TK4020F-TK4020V, TK65F-TK65V, TK70VA, TK75V-TK75VA	5193415	
14165	125	-	Rullo Cpt.1B con boccola / Tracking Cpt.1B with bushing - Ref. Berco FT3541		TK4020F-TK4020V, TK65F-TK65V, TK70VA, TK75V-TK75VA	5193323	
83165	125	-	Rullo Cpt.2B con boccola / Tracking Cpt.2B with bushing - Ref. Berco FT3580		TK4020F, TK4020V, TK4030V, TK60-TK70-TK75, TK65F, TK65V, TK70FA, TK70VA, TK75V, TK75VA	5177416, 5193324	
14170	125	-	Suola a 1 costa da 250 mm - Shoe 1 grouser 250 mm - Ref. Berco FT1238/250		TK65V, TK75V	5193416	
84394	125	-	Suola a 1 costa da 280 mm - Shoe 1 grouser 280 mm - Ref. Berco FT1238/280		TK70VA	5127837	
16488	125	-	Suola a 1 costa da 300 mm - Shoe 1 grouser 300 mm - Ref. Berco FT1238/300		TK65F	5193417	
84395	125	-	Suola a 1 costa da 310 mm - Shoe 1 grouser 310 mm - Ref. Berco FT1238/310		TK4020-TK4020F	-	
16487	125	-	Ruota Motrice - Sprocket - Ref. Berco FT667		-	-	
16492	125	-	Ruota Motrice - Sprocket - Ref. Berco FT2289		TK100A, TK4020F, TK4020V, TK55-65F, TK55-75F, TK55-85F, TK55-85M, TK55-85V, TK60-85F, TK60-85V, TK65F, TK65V, TK70FA, TK70VA, TK75F, TK75FA, TK75M, TK75MA, TK75V, TK75VA, TK76, TK76M, TK80A, TK80MA, TK85, TK85M, TK90A, TK90MA, TK95M	5129972	
18207	125	-	Ruota Motrice - Sprocket - Ref. Berco FT2290		TK100A, TK4020F, TK4020V, TK4030V, TK65F, TK65V, TK70FA, TK70VA, TK75F, TK75FA, TK75M, TK75MA, TK75V, TK75VA, TK76, TK76M, TK80A, TK80MA, TK85, TK85M, TK90A, TK90MA, TK95M	5112858, 5129967	

**VITI E BULLONI PER CATENE CON PASSO 125**

VIT ET BOLLONS CHAÎNE AVEC PITCH 125  
 SCREWS AND BOLTS CHAIN WITH PITCH 125  
 SCHRAUBEN UND BOLZEN KETTE MIT PITCH 125  
 TORNILLOS Y PERNOS CADENA CON PARCELA 125



Art./Ref.	Passo/Pitch	Note/Notes	Brand	Applicazione/Application	Rif. Orig./Orig. Ref.	Immagine/Image
12718	125	Vite per suola M10x1 - Screw M10X1 x shoe - Ref Berco FT1012	FIAT	355C	5144980, 557155	
14095	125	Dado x suola M10x1 - Nut M10X1 x shoe - Ref. Berco FT1029		355C	5144981, 557156	

**CINGOLATURE CON PASSO CATENE DA 140 MM ADATTABILI FIAT**

PISTES AVEC CHAINES PITCH 140 MM ADAPTABLE FIAT

TRACKS WITH PITCH CHAINS 140 MM ADAPTABLE FIAT

TRACKS MIT PITCH CHAINS 140 MM PASSEND ZU FIAT

LAS PISTAS CON CADENA DE PASO 140 MM ADAPTABLE FIAT

Art./Ref.	Passo/Pitch	Maglie/Links	Note/Notes	Brand	Applicazione/Application	Rif. Orig./Orig. Ref.	Immagine/Image
<b>17156</b>	140	32	Catena passo 140 mm da 32 maglie - Chain pitch 140 mm 32 links - Ref. Berco FT1351/32	<b>FIAT</b>	411-411C-411CI, 431C VIGNETO, 451C MONTAGNA, 455 FIRST TYPE, 455C FIRST TYPE, 455M-455V, 505C-505C SUPER, 505CM MONTAGNA, 505CV VIGNETO, AD4, AG4	580372	
<b>18221</b>	140	33	Catena passo 140 mm da 33 maglie - Chain pitch 140 mm 33 links - Ref. Berco FT1351/33		565, 565C-565CL-565CM, 60.65-60.65 MONTAGNA, 60.75, 60.75-60.75 MONTAGNA, 62.85, 62.85-62.85 MONTAGNA	5112815, 5193482	
<b>16484</b>	140	35	Catena passo 140 mm da 35 maglie - Chain pitch 140 mm 35 links - Ref. Berco FT1351/35		40CA, 555-555C-555M, 605C-605C SUPER-605CM MONTAGNA, 605CS, FL4	580373	
<b>14175</b>	140	36	Catena passo 140 mm da 36 maglie - Chain pitch 140 mm 36 links - Ref. Berco FT1351/36		665C-665CM, 70.65-70.65 MONTAGNA, 70.75-70.75 MONTAGNA, FL4C, FL4CH, FL4D, FL4L, FL4M	4955093, 5112816	
<b>18222</b>	140	37	Catena passo 140 mm da 37 maglie - Chain pitch 140 mm 37 links - Ref. Berco FT1351/37		765C, 80.65, 80.75	5112817, 87661068	
<b>14171</b>	140	-	Rullo Cpt.1B con boccola - Ref. Berco FT2954//Tracking Cpt.1B with bushing - Berco Ref. FT2954		40CA, 505C, 555-555C-555M, 605C, 605CM MONTAGNA, 605CS, 665C-665CM, 70.65-70.65 MONTAGNA, 70.75-70.75 MONTAGNA, 72.85-72.85 MONTAGNA, 765C, 80.65, 80.75-80.75 HD, 82.85M, 88.85 MONTAGNA, FL4-FL4C-FL4CH-FL4D-FL4L-FL4M	4964281, 4993395, 5109814, 5111357, 5193567, 597432, 79048331	
<b>14171A</b>	140	-	Rullo AMA (NO ITR) Cpt.1B con boccola - Ref. Berco FT2954//Tracking AMA (NO ITR) Cpt.1B with bushing - Ref. Berco FT2954				
<b>14173</b>	140	-	Rullo Cpt.2B con boccola - Ref. Berco FT2953//Tracking Cpt.2B with bushing - Ref. Berco FT2953		40CA, 505C, 555-555C-555M, 605C, 605CM MONTAGNA, 605CS, 665C-665CM, 70.65-70.65 MONTAGNA, 70.75-70.75 MONTAGNA, 72.85-72.85 MONTAGNA, 765C, 80.65, 80.75-80.75 HD, 82.85M, 88.85 MONTAGNA, FL4-FL4C-FL4CH-FL4D-FL4L-FL4M	4964280, 4974356, 4993394, 5111356, 5193566, 597431	
<b>14173A</b>	140	-	Rullo AMA (NO ITR) Cpt.2B con boccola - Ref. Berco FT2953//Tracking AMA (NO ITR) Cpt.2B with bushing - Ref. Berco FT2953				
<b>15970</b>	140	-	Rullo Superiore / Upper roller - Ref. Berco FT1619		40CA, 555-555C-555M, 60.65-60.65 MONTAGNA, 60.75-60.75 MONTAGNA, 605C, 605C SUPER-605CM MONTAGNA, 605CS, 62.85-62.85 MONTAGNA, 665C-665CM, 70.65-70.65 MONTAGNA, 70.75-70.75 MONTAGNA, 72.85-72.85 MONTAGNA, 765C, 80.65, 80.75-80.75HD, 82.85M, 88.85 MONTAGNA, FL4-FL4C-FL4CH-FL4D-FL4L-FL4M	5193367	
<b>15974</b>	140	-	Suola a 1 costa da 310 mm - Shoe 1 grouser 310 mm - Ref. Berco FT2066/310		411-411C-411CI, 505C SUPER, 505CV VIGNETO, 555-555C, 565-565C, 60.65, 60.75, 605-605C-605C SUPER-605CS, 62.85, 665-665C, 70.65, 70.75, 72.85	5193477	
<b>14180</b>	140	-	Suola a 1 costa da 360 mm - Shoe 1 grouser 360 mm - Ref. Berco FT2066/360		451C MONTAGNA, 455M, 505CM MONTAGNA, 555M, 565CL-565CM, 60.65 MONTAGNA, 60.75 MONTAGNA, 605CM MONTAGNA, 665CM, 70.65 MONTAGNA, 70.75 MONTAGNA, 765C, 80.65, 80.75-80.75 HD	568251	
<b>14181</b>	140	-	Suola a 1 costa da 400 mm - Shoe 1 grouser 400 mm - Ref. Berco FT2066/400		82.85 M	5115935	
<b>84396</b>	140	-	Suola a 1 costa da 450 mm - Shoe 1 grouser 450 mm - Ref. Berco FT2066/450	82.85 M	5164685		

Art./Ref.	Passo/Pitch	Maglie/Links	Note/Notes	Brand	Applicazione/Application	Rif. Orig./Orig. Ref.	Immagine/Image
16482	140	-	Suola a 3 coste da 260 mm - Shoe 3 grouzers 260 mm - Ref. Berco FT1234/260	FIAT	FL4-FL4C-FL4CH-FL4D	573491, 578001, 79049324	
16483	140	-	Suola a 3 coste da 300 mm - Shoe 3 grouzers 300 mm - Ref. Berco FT1234/300		FL4 L-FL4 M-FL4	79014081, 79050071	
14177	140	-	Ruota Motrice - Sprocket - Ref. Berco FT746		40CA, 411C-411CI, 431C VIGNETO, 451C MONTAGNA, 455 FIRST TYPE, 455C FIRST TYPE, 455M, 455V, 505C-505C SUPER, 505CM MONTAGNA, 505CV VIGNETO, 555-555C-555M, 60.75-60.75 MONTAGNA, 605C, 605C SUPER-605CM MONTAGNA, 605CS, AD4-AG4, FL4, FL4C-FL4CH-FL4D	4957406, 566417	
16425	140	-	Ruota Motrice - Sprocket - Ref. Berco FT2291		565C-565CL-565CM, 60.65-60.65 MONTAGNA, 62.85.62.85 MONTAGNA, 665C-665CM, 70.65-70.65 MONTAGNA, 70.75-70.75 MONTAGNA, 72.85-72.85 MONTAGNA, 765C, 80.65, 80.75	5112850, 5130451, 5142888	
84398	140	-	Ruota Motrice - Sprocket - Ref. Berco FT3295		80.75 HD, 82.85M, 88.85 MONTAGNA	5153633	
89202	140	37	Catena passo 140 mm da 37 maglie boccia da 41 - Chain pitch 140 mm 37 links bushing 41 - Ref. Berco FT3141/37		80.75, 82.85M	5153656	

**CINGOLATURE CON PASSO CATENE DA 140 MM ADATTABILI LAMBORGHINI**

PISTES AVEC CHAINES PITCH 140 MM ADAPTABLE LAMBORGHINI  
 TRACKS WITH PITCH CHAINS 140 MM ADAPTABLE LAMBORGHINI  
 TRACKS MIT PITCH CHAINS 140 MM PASSEND ZU LAMBORGHINI  
 LAS PISTAS CON CADENA DE PASO 140 MM ADAPTABLE LAMBORGHINI



Art./Ref.	Passo/Pitch	Maglie/Links	Note/Notes	Brand	Applicazione/Application	Rif. Orig./Orig. Ref.	Immagine/Image
17156	140	32	Catena passo 140 mm da 32 maglie - Chain pitch 140 mm 32 links - Ref. Berco FT1351/32	LAMBORGHINI	C345-C345L-C345LL-C345S, C355-C355L, C503-C503L/LL/S, C553L/LL/S, C583L/S	0.424.9450.4	
18221	140	33	Catena passo 140 mm da 33 maglie - Chain pitch 140 mm 33 links - Ref. Berco FT1351/33		C603 /L		
16484	140	35	Catena passo 140 mm da 35 maglie - Chain pitch 140 mm 35 links - Ref. Berco FT1351/35		C674/L/N, C684/L	0.007.9463.4, 0.191.9450.4	
14171	140	-	Rullo Cpt.1B con boccia - Ref. Berco FT2954//Tracking Cpt.1B with bushing - Berco Ref. FT2954		C345-C345/L-C345/LL-C345S, C355-C355/L, C503-C503L/LL/S, C553/L/LL/S, C583/L/S, C603/L, C653/L, C674/L/N, C683/L, C684/L	0.007.9446.4, 0.216.9215.3, 0.424.9215.4	
14171A	140	-	Rullo AMA (NO ITR) Cpt.1B con boccia - Ref. Berco FT2954//Tracking AMA (NO ITR) Cpt.1B with bushing - Ref. Berco FT2954				
14173	140	-	Rullo Cpt.2B con boccia - Ref. Berco FT2953//Tracking Cpt.2B with bushing - Ref. Berco FT2953		C603/L, C653/L, C674/L-N, C683/L, C684/L	0.007.9445.4/10, 0.216.9214.3, 0.424.9214.4	
14173A	140	-	Rullo AMA (NO ITR) Cpt.2B con boccia - Ref. Berco FT2953//Tracking AMA (NO ITR) Cpt.2B with bushing - Ref. Berco FT2953				

Art./Ref.	Passo/Pitch	Maglie/Links	Note/Notes	Brand	Applicazione/Application	Rif. Orig./Orig. Ref.	Immagine/Image
<b>84397</b>	140	-	Rullo superiore con albero - Upper roller shaft - Ref. Berco LA337	<b>LAMBORGHINI</b>	C105, C350/L, C352L/S/SL, C453/L, C553/L/LL, C583L, C603/L, C653/L, C674/L/N, C683/L, C684L, C754/L, C774, C784L, C874	0.007.8857.4/10, 0.216.9230.4, 0.292.9230.4	
<b>14177</b>	140	-	Ruota Motrice - Sprocket - Ref. Berco FT746/Sprocket - Berco ref. FT746		MINITAURO 60C, TAURUS C	-	
<b>84399</b>	140	-	Ruota Motrice - Sprocket - Ref. Berco LB146/Sprocket - Berco ref. LB146		C105, C754L, C774/80, C784L, C874/90	0.294.9210.0	
<b>58301</b>	140	37	Catena passo 140 mm da 37 maglie - Chain pitch 140 mm 37 links - Ref. Berco LA308/37		C105, C754/L, C774, C784L, C874/90	0.007.8946.4, 0.216.9450.4	
<b>15981</b>	140	-	Rullo Cpt.1B con boccola / Tracking Cpt.1B with bushing - Ref. Berco FT3768		C105, C754/L, C774, C784/L, C874/90	0.007.9359.4	
<b>15982</b>	140	-	Rullo Cpt.2B con boccola / Tracking Cpt.2B with bushing - Ref. Berco FT3769		C105, C754/L, C774, C784/L, C874/90	0.007.9358.4	

**CINGOLATURE CON PASSO CATENE DA 140 MM ADATTABILI LANDINI**
*PISTES AVEC CHAINES PITCH 140 MM ADAPTABLE LANDINI*
*TRACKS WITH PITCH CHAINS 140 MM ADAPTABLE LANDINI*
*TRACKS MIT PITCH CHAINS 140 MM PASSEND ZU LANDINI*
*LAS PISTAS CON CADENA DE PASO 140 MM ADAPTABLE LANDINI*

Art./Ref.	Passo/Pitch	Maglie/Links	Note/Notes	Brand	Applicazione/Application	Rif. Orig./Orig. Ref.	Immagine/Image
<b>17156</b>	140	32	Catena passo 140 mm da 32 maglie - Chain pitch 140 mm 32 links - Ref. Berco FT1351/32	<b>LANDINI</b>	C4500, C5000, CL5000 SPECIAL	975865M91	
<b>18221</b>	140	33	Catena passo 140 mm da 33 maglie - Chain pitch 140 mm 33 links - Ref. Berco FT1351/33		5500-5500M-5500S, 5830C-5830CL-5830CS, 6030C-6030CL-6030CS, 6060-6060L-6060S	3538968M91	
<b>16484</b>	140	35	Catena passo 140 mm da 35 maglie - Chain pitch 140 mm 35 links - Ref. Berco FT1351/35		6500-6500M-6500S, 6830-6830C-6830CL	1825107M91, 3531482M91, 3538965M91	
<b>14175</b>	140	36	Catena passo 140 mm da 36 maglie - Chain pitch 140 mm 36 links - Ref. Berco FT1351/36		CI4000MARK II, CI5000	973501M91	
<b>18222</b>	140	37	Catena passo 140 mm da 37 maglie - Chain pitch 140 mm 37 links - Ref. Berco FT1351/37		CF85 LARGO, CF85 STD, TREKKER 65F, TREKKER 65F MONTAGNA, TREKKER 75F, TREKKER 75F MONTAGNA, TREKKER 75F STD, TREKKER 80F	3542025M91	
<b>14171</b>	140	-	Rullo Cpt.1B con boccola - Ref. Berco FT2954//Tracking Cpt.1B with bushing - Berco Ref. FT2954		6500-6500M-6500S, 6830C-6830CL, C6000, CF85 LARGO-CF85 STD, CI4000 MARK II, CI5000, CL6000, TREKKER 65F-65F MONTAGNA, TREKKER 75F-75F MONTAGNA, TREKKER 75FS, TREKKER 80F	3538901M91	
<b>14171A</b>	140	-	Rullo AMA ( <b>NO ITR</b> ) Cpt.1B con boccola - Ref. Berco FT2954//Tracking AMA ( <b>NO ITR</b> ) Cpt.1B with bushing - Ref. Berco FT2954				

Art./Ref.	Passo/Pitch	Maglie/Links	Note/Notes	Brand	Applicazione/Application	Rif. Orig./Orig. Ref.	Immagine/Image	
14173	140	-	Rullo Cpt.2B con boccia - Ref. Berco FT2953//Tracking Cpt.2B with bushing - Ref. Berco FT2953	LANDINI	6500-6500M-6500S, 6830C-6830CL, C6000, C6830, CF85 LARGO-CF85 STD, C14000 MARK II, C15000, CL6000, TREKKER 65F-65F MONTAGNA, TREKKER 75F-75F MONTAGNA, TREKKER 75FS, TREKKER 80F	3538902M91		
14173A	140	-	Rullo AMA (NO ITR) Cpt.2B con boccia - Ref. Berco FT2953//Tracking AMA (NO ITR) Cpt.2B with bushing - Ref. Berco FT2953					
15970	140	-	Rullo Superiore / Upper roller - Ref. Berco FT1619			5500-5500M-5500S, 5830C-5830CL-5830CS, 6030C-6030CL-6030CS, 6060-6060L-6060S, 6500-6500M-6500S, 6830C-6830CL, C4500, CF85 LARGO-CF85 STD, TREKKER 100F-100M, TREKKER 105F-105M, TREKKER 65F-65F MONTAGNA, TREKKER 75F-75F MONTAGNA, TREKKER 75FSTD, TREKKER 80F-80F MONTAGNA, TREKKER 85F LARGO, TREKKER 85F/R MONTAGNA, TREKKER 85FSTD, TREKKER 90F-M, TREKKER 95STD	3311678M91, 3531605M91, 3538489M91	
84397	140	-	Rullo superiore con albero - Upper roller shaft - Ref. Berco LA337			7500, 7800, 7830-7830L-7830S, 8860, C5000, C6000, CL6000	1432374M91, 1438039M91, 3531829M91	
15974	140	-	Suola a 1 costa da 310 mm - Shoe 1 grouser 310 mm - Ref. Berco FT2066/310			5500-5500S, 5830C-5830CS, 6030C-6030CS, 6060-6060S, 6500-6500S, 6830C, C4500-C5000-C6000, CL5000 SPECIAL, CL6000, TREKKER 65F	973691M1	
14180	140	-	Suola a 1 costa da 360 mm - Shoe 1 grouser 360 mm - Ref. Berco FT2066/360			5500M, 5830CL, 6030CL, 6060L, 6500M, 6830CL, CF85 STD, TREKKER 65F MONTAGNA, TREKKER 75F-75F STD, TREKKER 80F	977760M1	
14181	140	-	Suola a 1 costa da 400 mm - Shoe 1 grouser 400 mm - Ref. Berco FT2066/400			CF85 LARGO, TREKKER 75F MONTAGNA	3546060M1	
84396	140	-	Suola a 1 costa da 450 mm - Shoe 1 grouser 450 mm - Ref. Berco FT2066/450			CF85 LARGO, TREKKER 75F MONTAGNA	-	
16482	140	-	Suola a 3 coste da 260 mm - Shoe 3 grousers 260 mm - Ref. Berco FT1234/260			C14000 MARK II, C15000	-	
72706	140	-	Ruota Motrice - Sprocket - Ref. Berco LA459/Sprocket - Berco Ref. LA459			5500-5500M-5500S, 5830C-5830CL-5830CS, 6030C-6030CL-6030CS, 6060-6060L-6060S, 6500-6500M-6500S, 6830C-6830CL	1824729M1	
89204	140	-	Ruota Motrice - Sprocket - Ref. Berco LA537/Sprocket - Berco ref. LA537			TREKKER 100 F, TREKKER 100 M, TREKKER 105 F, TREKKER 105 M, TREKKER 80 F MONTAGNA, TREKKER 85 F LARGO, TREKKER 85 F STD, TREKKER 85 F-R MONTAGNA, TREKKER 90 F, TREKKER 90 M, TREKKER 95 STD	3539458M2	
89203	140	36	Catena passo 140 mm da 36 maglie - Chain pitch 140 mm 36 links - Ref. Berco LA308/36			7500, 7800, 7830 - 7830L - 7830S, 8860	1428051M91, 3306376M91, 3531474M91, 3533777M91, 3538949M91	
58301	140	37	Catena passo 140 mm da 37 maglie - Chain pitch 140 mm 37 links - Ref. Berco LA308/37		TREKKER 100F-100M, TREKKER 105F-105M, TREKKER 80F MONTAGNA, TREKKER 90F-90M	3542028M91		

Art./Ref.	Passo/Pitch	Maglie/Links	Note/Notes	Brand	Applicazione/Application	Rif. Orig./Orig. Ref.	Immagine/Image
15981	140	-	Rullo Cpt.1B con boccola / Tracking Cpt.1B with bushing - Ref. Berco FT3768	LANDINI	7500, 7800, 7830-7830L-7830S, 8860, TREKKER 100F, TREKKER 100M, TREKKER 105F, TREKKER 105M, TREKKER 80F MONTAGNA, TREKKER 85F LARGO, TREKKER 85F STD, TREKKER 85F/R MONTAGNA, TREKKER 90 M, TREKKER 90F, TREKKER 95STD	3218024M91, 3218027M91, 3539029M91	
15982	140	-	Rullo Cpt.2B con boccola / Tracking Cpt.2B with bushing - Ref. Berco FT3769		7500, 7800, 7830-7830L-7830S, 8860, TREKKER 100F, TREKKER 100M, TREKKER 105F, TREKKER 105M, TREKKER 80F MONTAGNA, TREKKER 85F LARGO, TREKKER 85F STD, TREKKER 85F/R MONTAGNA, TREKKER 90F, TREKKER 90M, TREKKER 95STD	3218026M91, 3531417M91, 3539028M91	
84431	140	-	Suola a 1 costa da 360 mm - Shoe 1 grouser 360 mm - Ref. Berco LA217/360		7830, TREKKER 100, TREKKER 105, TREKKER 90	1844114M1	
15988	140	-	Suola a 1 costa da 400 mm - Shoe 1 grouser 400 mm - Ref. Berco LA217/400		7500, 7800, 7830-7830L, 8860, TREKKER 100M, TREKKER 105M, TREKKER 80F MONTAGNA, TREKKER 85F STD, TREKKER 90M	3300455M1	
84429	140	-	Suola a 1 costa da 450 mm - Shoe 1 grouser 450 mm - Ref. Berco LA217/450		TREKKER 85F LARGO, TREKKER 85F/R MONTAGNA, TREKKER 95STD	3546225M1	

**CINGOLATURE CON PASSO CATENE DA 140 MM ADATTABILI MASSEY FERGUSON**

PISTES AVEC CHAINES PITCH 140 MM ADAPTABLE MASSEY FERGUSON  
 TRACKS WITH PITCH CHAINS 140 MM ADAPTABLE MASSEY FERGUSON  
 TRACKS MIT PITCH CHAINS 140 MM PASSEND ZU MASSEY FERGUSON  
 LAS PISTAS CON CADENA DE PASO 140 MM ADAPTABLE MASSEY FERGUSON



Art./Ref.	Passo/Pitch	Maglie/Links	Note/Notes	Brand	Applicazione/Application	Rif. Orig./Orig. Ref.	Immagine/Image
17156	140	32	Catena passo 140 mm da 32 maglie - Chain pitch 140 mm 32 links - Ref. Berco FT1351/32	MASSEY FERGUSON		975865M91	
18221	140	33	Catena passo 140 mm da 33 maglie - Chain pitch 140 mm 33 links - Ref. Berco FT1351/33		MF154C-MF154CL-MF154CS, MF254C-MF254CL-MF254CS, MF264C-MF264CL-MF264CS, MF364C-MF364CF LARGO, MF364CF STRETTO	3538968M91	
16484	140	35	Catena passo 140 mm da 35 maglie - Chain pitch 140 mm 35 links - Ref. Berco FT1351/35		MF174C-MF174CL-MF174CS, MF274CF-MF274CF LARGO	3531482M91, 3538965M91	
14175	140	36	Catena passo 140 mm da 36 maglie - Chain pitch 140 mm 36 links - Ref. Berco FT1351/36		MF2244DOZER, MF2244LOADER, MF244, MF244 MARK II	973501M91	
14171	140	-	Rullo Cpt.1B con boccola - Ref. Berco FT2954//Tracking Cpt.1B with bushing - Berco Ref. FT2954		MF154C-MF154CL-MF154CS, MF174C-MF174CL-MF174CS, MF2244 DOZER-LOADER, MF244-MF244 MARK II, MF254C-MF254CL-MF254CS, MF264C-MF264CL-MF264CS, MF274CF-MF274CF LARGO, MF364CF STRETTO, MF364CF-MF364CF LARGO	3538901M91	
14171A	140	-	Rullo AMA (NO ITR) Cpt.1B con boccola - Ref. Berco FT2954//Tracking AMA (NO ITR) Cpt.1B with bushing - Ref. Berco FT2954				
14173	140	-	Rullo Cpt.2B con boccola - Ref. Berco FT2953//Tracking Cpt.2B with bushing - Ref. Berco FT2953		MF154C-MF154CL-MF154CS, MF174C-MF174CL-MF174CS, MF2244 DOZER-MF2244 LOADER, MF244-MF244 MARK II, MF274CF-MF274CF LARGO	3538902M91	
14173A	140	-	Rullo AMA (NO ITR) Cpt.2B con boccola - Ref. Berco FT2953				
15970	140	-	Rullo Superiore / Upper roller - Ref. Berco FT1619		MF154C-MF154CL-MF154CS, MF174C-MF174CL-MF174CS, MF254C-MF254CL-MF254CS, MF264C-MF264CL-MF264CS, MF274CF-MF274CF LARGO, MF364CF STRETTO, MF364CF-MF364CF LARGO	1825153M91, 3538489M91	
84397	140	-	Rullo superiore con albero - Upper roller shaft - Ref. Berco LA337		MF194C, MF200 DOZER-LOADER, MF200B-MF200C-MF200D, MF2244 DOZER-LOADER, MF244-MF244 MARK II, MF250, MF294C, MF330	3531829M91	



Art./Ref.	Passo/Pitch	Maglie/Links	Note/Notes	Brand	Applicazione/Application	Rif. Orig./Orig. Ref.	Immagine/Image
15974	140	-	Suola a 1 costa da 310 mm - Shoe 1 grouser 310 mm - Ref. Berco FT2066/310	<b>MASSEY FERGUSON</b>	MF154-MF154C-MF154CS, MF174-MF174C-MF174CS, MF2244 DOZER, MF254-MF254C-MF254CS, MF264- MF264C-MF264CS, MF274-MF274CS, MF364CF- MF364CF STRETTO	973691M1	
14180	140	-	Suola a 1 costa da 360 mm - Shoe 1 grouser 360 mm - Ref. Berco FT2066/360		MF154CL, MF174CL, MF254CL, MF264CL, MF274CF LARGO, MF364CF LARGO	977760M1	
16482	140	-	Suola a 3 coste da 260 mm - Shoe 3 grousers 260 mm - Ref. Berco FT1234/260		MF2244 LOADER, MF244-MF244 MARK II		
72706	140	-	Ruota Motrice - Sprocket - Ref. Berco LA459		MF154C-MF154CL-MF154CS, MF174C-MF174CL- MF174CS, MF254C-MF254CL-MF254CS, MF264C- MF264CL-MF264CS, MF274CF-MF274CF LARGO, MF364CF STRETTO, MF364CF-MF364CF LARGO	1824729M1	
89204	140	-	Ruota Motrice - Sprocket - Ref. Berco LA537		3435 C, 396, 396 T	3539458M2	
89203	140	36	Catena passo 140 mm da 36 maglie - Chain pitch 140 mm 36 links - Ref. Berco LA308/36		MF194C, MF200 DOZER, MF200 LOADER, MF200B - MF200C, MF294C	1428051M91, 3306376M91, 3531474M91, 3533777M91, 3538949M91	
58301	140	37	Catena passo 140 mm da 37 maglie - Chain pitch 140 mm 37 links - Ref. Berco LA308/37		MF200D	3542028M91	
15981	140	-	Rullo Cpt.1B con boccola / Tracking Cpt.1B with bushing - Ref. Berco FT3768		MF194C, MF200 DOZER-LOADER, MF200B, MF200C, MF200D, MF250, MF294C, MF330	3304405M91, 3539029M91	
15982	140	-	Rullo Cpt.2B con boccola / Tracking Cpt.2B with bushing - Ref. Berco FT3769		MF194C, MF200 DOZER-LOADER, MF200B, MF200C, MF200D, MF250, MF294C, MF330	1428037M91, 1428260M91, 3304404M91, 3539028M91	
84430	140	-	Suola a 1 costa da 310 mm - Shoe 1 grouser 310 mm - Ref. Berco LA217/310		MF200 DOZER	1844113M1	
84431	140	-	Suola a 1 costa da 360 mm - Shoe 1 grouser 360 mm - Ref. Berco LA217/360		MF394C	1844114M1, 3304061M1	
15988	140	-	Suola a 1 costa da 400 mm - Shoe 1 grouser 400 mm - Ref. Berco LA217/400		MF194C, MF294C	3304062M1	

**CINGOLATURE CON PASSO CATENE DA 140 MM ADATTABILI NEW HOLLAND**

PISTES AVEC CHAINES PITCH 140 MM ADAPTABLE NEW HOLLAND

TRACKS WITH PITCH CHAINS 140 MM ADAPTABLE NEW HOLLAND

TRACKS MIT PITCH CHAINS 140 MM PASSEND ZU NEW HOLLAND

LAS PISTAS CON CADENA DE PASO 140 MM ADAPTABLE NEW HOLLAND



Art./Ref.	Passo/Pitch	Maglie/Links	Note/Notes	Brand	Applicazione/Application	Rif. Orig./Orig. Ref.	Immagine/Image
17156	140	32	Catena passo 140 mm da 32 maglie - Chain pitch 140 mm 32 links - Ref. Berco FT1351/32	NEW HOLLAND	HD VAR507, HD VAR531, TK65, TK65F, TK65V, TK75, TK75F, TK75V	87661064	
18221	140	33	Catena passo 140 mm da 33 maglie - Chain pitch 140 mm 33 links - Ref. Berco FT1351/33		TK4030-TK4030F-TK4030V, TK75FA	5193482	
16484	140	35	Catena passo 140 mm da 35 maglie - Chain pitch 140 mm 35 links - Ref. Berco FT1351/35		-	-	
14175	140	36	Catena passo 140 mm da 36 maglie - Chain pitch 140 mm 36 links - Ref. Berco FT1351/36		TK76-TK76M	5112816	
18222	140	37	Catena passo 140 mm da 37 maglie - Chain pitch 140 mm 37 links - Ref. Berco FT1351/37		-	-	
14171	140	-	Rullo Cpt.1B con boccia - Ref. Berco FT2954//Tracking Cpt.1B with bushing - Ref. Berco FT2954		TK4030-TK4030F-TK4030V, TK4040-TK4040M, TK4050, TK75F-TK75FA, TK76-TK76M, TK80A-TK80MA, TK85-TK85M, TK90A-TK90MA	5111357, 5193567, 87661070	
14171A	140	-	Rullo AMA (NO ITR) Cpt.1B con boccia - Ref. Berco FT2954/Tracking AMA (NO ITR) Cpt.1B with bushing - Ref. Berco FT2954				
14173	140	-	Rullo Cpt.2B con boccia - Ref. Berco FT2953/Tracking Cpt.2B with bushing - Ref. Berco FT2953		TK4030F-TK4030V, TK4040-TK4040M, TK4050, TK75F-TK75FA, TK76-TK76M, TK80A-TK80MA, TK85-TK85M, TK90A-TK90MA	5111356, 5193566, 87661069	
14173A	140	-	Rullo AMA (NO ITR) Cpt.2B con boccia - Ref. Berco FT2953/Tracking AMA (NO ITR) Cpt.2B with bushing - Ref. Berco FT2953				
15970	140	-	Rullo Superiore / Upper roller - Ref. Berco FT1619		HD VAR531, TK65F, TK75F-TK75FA, TK76-TK76M, TK80A-TK80MA, TK85-TK85M, TK90A-TK90MA, TK95M	5193367	
84397	140	-	Rullo superiore con albero - Upper roller shaft - Ref. Berco LA337		DC70 LGP	-	
15974	140	-	Suola a 1 costa da 310 mm - Shoe 1 grouser 310 mm - Ref. Berco FT2066/310		TF4030-TK4030F, TK4040, TK65 HD VAR531, TK65F, TK75-TK75F-TK75FA, TK76, TK80-TK80A, TK85, TK90-TK90A	5193477	
14181	140	-	Suola a 1 costa da 400 mm - Shoe 1 grouser 400 mm - Ref. Berco FT2066/400		TK85M, TK90MA	5193466	
84396	140	-	Suola a 1 costa da 450 mm - Shoe 1 grouser 450 mm - Ref. Berco FT2066/450		TK85M, TK90MA	5164685	
16425	140	-	Ruota Motrice - Sprocket - Ref. Berco FT2291	TK4040, TK76-TK76M	5142888		
84398	140	-	Ruota Motrice - Sprocket - Ref. Berco FT3295	TK100A, TK4040M, TK4050-TK4050M, TK4060, TK80A-TK80MA, TK85-TK85M, TK90A-TK90MA, TK95M	5153633		

Art./Ref.	Passo/Pitch	Maglie/Links	Note/Notes	Brand	Applicazione/Application	Rif. Orig./Orig. Ref.	Immagine/Image
89201	140	36	Catena passo 140 mm da 36 maglie boccola da 41 - Chain pitch 140 mm 36 links bushing 41 - Ref. Berco FT3141/36	NEW HOLLAND	TK4030 - TK4030F - TK4030V, TK4040 - TK4040M, TK4050, TK76 - TK76M, TK80A - TK80MA, TK90A - TK90MA	5193479	
89202	140	37	Catena passo 140 mm da 37 maglie boccola da 41 - Chain pitch 140 mm 37 links bushing 41 - Ref. Berco FT3141/37		TK4030 - TK4030F - TK4030V, TK4040 - TK4040M, TK4050, TK80A - TK80MA, TK85 - TK85M, TK90A - TK90MA	5193480	
15981	140	-	Rullo Cpt.1B con boccola / Tracking Cpt.1B with bushing - Ref. Berco FT3768		TK100A, TK4050M, TK4060, TK95M	5182732	
15982	140	-	Rullo Cpt.2B con boccola / Tracking Cpt.2B with bushing - Ref. Berco FT3769		TK100A, TK4050M, TK4060, TK95M	5182733	
84429	140	-	Suola a 1 costa da 450 mm - Shoe 1 grouser 450 mm - Ref. Berco LA217/450		TK100A, TK4050M, TK4060, TK95M	5184225, 5193340	

**CINGOLATURE CON PASSO CATENE DA 140 MM ADATTABILI SAME**

PISTES AVEC CHAINES PITCH 140 MM ADAPTABLE SAME  
 TRACKS WITH PITCH CHAINS 140 MM ADAPTABLE SAME  
 TRACKS MIT PITCH CHAINS 140 MM PASSEND ZU SAME  
 LAS PISTAS CON CADENA DE PASO 140 MM ADAPTABLE SAME



Art./Ref.	Passo/Pitch	Maglie/Links	Note/Notes	Brand	Applicazione/Application	Rif. Orig./Orig. Ref.	Immagine/Image
17156	140	32	Catena passo 140 mm da 32 maglie - Chain pitch 140 mm 32 links - Ref. Berco FT1351/32	SAME	SOLAR 60C	0.424.9450.4	
16484	140	35	Catena passo 140 mm da 35 maglie - Chain pitch 140 mm 35 links - Ref. Berco FT1351/35		EXPLORER 65C, EXPLORER 70C	0.007.9463.4, 0.191.9450.4	
14175	140	36	Catena passo 140 mm da 36 maglie - Chain pitch 140 mm 36 links - Ref. Berco FT1351/36		MINITAURO 60C, TAURUS C	-	
14171	140	-	Rullo Cpt.1B con boccola - Ref. Berco FT2954//Tracking Cpt.1B with bushing - Berco Ref. FT2954		EXPLORER 65C-75C-70C, MINITAURO 60C, SOLAR 60C, TAURUS C	0.007.9446.4, 0.216.9215.3, 0.424.9215.4	
14171A	140	-	Rullo AMA (NO ITR) Cpt.1B con boccola - Ref. Berco FT2954// Tracking AMA (NO ITR) Cpt.1B with bushing - Ref. Berco FT2954				

Art./Ref.	Passo/Pitch	Maglie/Links	Note/Notes	Brand	Applicazione/Application	Rif. Orig./Orig. Ref.	Immagine/Image
<b>14173</b>	140	-	Rullo Cpt.2B con boccola - Ref. Berco FT2953//Tracking Cpt.2B with bushing - Ref. Berco FT2953	<b>SAME</b>	EXPLORER 65C-75C-70C, MINITAURO 60C, TAURUS C	0.007.9445.4/10, 0.216.9214.3, 0.424.9214.4	
<b>14173A</b>	140	-	Rullo AMA ( <b>NO ITR</b> ) Cpt.2B con boccola - Ref. Berco FT2953//Tracking AMA ( <b>NO ITR</b> ) Cpt.2B with bushing - Ref. Berco FT2953				
<b>15970</b>	140	-	Rullo Superiore / Upper roller - Ref. Berco FT1619		EXPLORER 65C-75C-70C, SOLAR 60C	-	
<b>84397</b>	140	-	Rullo superiore con albero - Upper roller shaft - Ref. Berco LA337		CONDOR C, EXPLORER 90C, FOX 45-55, KRYPTON F98C, MINITAURO 60C, SOLAR 55C, TAURUS C	0.007.8857.4/10, 0.216.9230.4, 0.292.9230.4	
<b>15974</b>	140	-	Suola a 1 costa da 310 mm - Shoe 1 grouser 310 mm - Ref. Berco FT2066/310			0.425.9411.0	
<b>14180</b>	140	-	Suola a 1 costa da 360 mm - Shoe 1 grouser 360 mm - Ref. Berco FT2066/360			0.160.9412.0, 0.425.9412.0	
<b>84399</b>	140	-	Ruota Motrice - Sprocket - Ref. Berco LB146		EXPLORER 80C-90C, KRYPTON 105, LEOPARD C	0.294.9210.0	
<b>58301</b>	140	37	Catena passo 140 mm da 37 maglie - Chain pitch 140 mm 37 links - Ref. Berco LA308/37		EXPLORER 75C, EXPLORER 80C-90C, LEOPARD C	0.007.8946.4, 0.216.9450.4	
<b>15981</b>	140	-	Rullo Cpt.1B con boccola / Tracking Cpt.1B with bushing - Ref. Berco FT3768		EXPLORER 80C, EXPLORER 90C, LEOPARD C	0.007.9359.4	
<b>15982</b>	140	-	Rullo Cpt.2B con boccola / Tracking Cpt.2B with bushing - Ref. Berco FT3769		EXPLORER 80C, EXPLORER 90C, KRYPTON F98C, LEOPARD C	0.007.9358.4	
<b>15988</b>	140	-	Suola a 1 costa da 400 mm - Shoe 1 grouser 400 mm - Ref. Berco LA217/400		-	0.216.9451.0	
<b>84429</b>	140	-	Suola a 1 costa da 450 mm - Shoe 1 grouser 450 mm - Ref. Berco LA217/450		-	0.007.8817.0	

**VITI E BULLONI PER CATENE CON PASSO 140**

VIT ET BOLLONS CHAÎNE AVEC PITCH 140  
 SCREWS AND BOLTS CHAIN WITH PITCH 140  
 SCHRAUBEN UND BOLZEN KETTE MIT PITCH 140  
 TORNILLOS Y PERNOS CADENA CON PARCELA 140



Art./Ref.	Passo/Pitch	Note/Notes	Brand	Applicazione/Application	Rif. Orig./Orig. Ref.	Immagine/Image
12806	140	Vite per suola M12x1 - Screw M12X1 x shoe - Ref Berco FT694	FIAT	605C, FL4	5117440, 571894	
12804	140	Dado x suola M12x1 - Nut M12X1 x shoe - Ref. Berco FT887		605C, FL4	5117441, 571946, 79031163	

**SOPRASSUOLE IN GOMMA**

PATIN DE ROUTE  
 RUBBER ROAD PADS  
 STRASSEN PLATTEN  
 PATIN DE CARRETERA

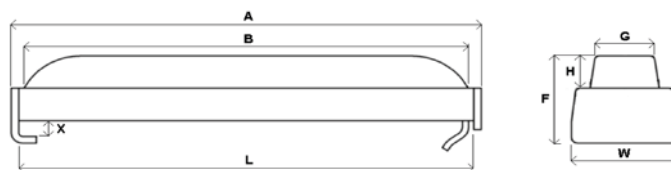

Art./Ref.	Passo/Pitch	Note/Notes	A mm	B mm	G mm	H mm	L mm	W mm	X mm
59826	140	Soprassuola in gomma da 310 mm - Rubber Road Pads 310 mm	325	305	47	29	361	85	12
64011	140	Soprassuola in gomma da 350 mm - Rubber Road Pads 350 mm	365	345	47	29	361	85	12
59828	140	Soprassuola in gomma da 360 mm - Rubber Road Pads 360 mm	375	355	47	29	361	85	12
59829	140	Soprassuola in gomma da 400 mm - Rubber Road Pads 400 mm	415	395	47	29	361	85	12
75395	140	Soprassuola in gomma da 450 mm - Rubber Road Pads 450 mm	465	445	47	29	361	85	12

**CINGOLI IN GOMMA ADATTABILI**

CHENILLE CAOUTCHOUC ADAPTABLE AICHI

RUBBER TRACKING ADAPTABLE TO AICHI

GUMMIRAUPEN PASSEND ZU AICHI

ORUGA DE GOMA ADAPTABLE AICHI



Brand	Art./Ref.	Misura/Size	Applicazione/Application
AICHI	28326	230cm x 72cm x 43cm	DM10
	28327	230cm x 72cm x 42cm	RV040, RV041
	62248	230cm x 72cm x 50cm	RV042
	62357	300cm x 55cm x 82 cm	FR300AA
AIRMANN	28344	180cm x 72cm x 36cm	HM07S
	28329	180cm x 72cm x 37cm	AX05, AX08, AX08.2
	62216	180cm x 72cm x 40cm	AX10U
	62227	200cm x 72cm x 40cm	AX10U
	28327	230cm x 72cm x 42cm	HM 15.5
	28330	230cm x 96cm x 31cm	AX12, AX12.2, AX15, AX15.2, AX12C, AXC15
	28331	230cm x 96cm x 33cm	AX16, AX16.2, AX16.2N, AX16CBL.3, AX17, AX17-2, AX17-2N, AX17CGL.2N, HM10, HM15
	84571	230cm x 96cm x 35cm	AX17U
	62257	250cm x 52,5cm x 73N cm	AX18.2, AX22, AX22.2, AX22CGL, AX25.3
	84577	250cm x 52,5cm x 78N cm	AX20UR, AX20UR.3
	62277	250cm x 96cm x 41K cm	AX20U
	62316	300cm x 52,5cm x 72N cm	AX22
	62322	300cm x 52,5cm x 76N cm	AX25, AX25.1, AX25.2, AX30UR, AX30UR.1, AX30UR.2
	62325	300cm x 52,5cm x 78N cm	AX27, AX27U, AX29U, AX29UCGL
	62328	300cm x 52,5cm x 80N cm	AX35.2
	62331	300cm x 52,5cm x 82N cm	AX30.1, AX30.2, AX30UR.3, AX32U, AX33MU, AX33U, AX35, AX35.2, AX35CGL.3
	62332	300cm x 52,5cm x 82W cm	HM30SGZ, HM30SZG
	62337	300cm x 52,5cm x 86N cm	AX30U.4, AX30UR.4, AX35U, AX36U, AX36UCGL
	62338	300cm X 52,5cm X 86W cm	HM35
	62353	300cm x 55cm x 74N cm	AX25, AX25.1, AX25.2, AX30UR, AX30UR.1, AX30UR.2
	62356	300cm x 55cm x 80N cm	AX30, AX30.1, AX30.2, AX30UR.3, AX32U, AX33MU, AX33U, AX35, AX35.1
	62286	300cm x 109cm x 35N cm	AX22
	62302	300cm x 109cm x 40W cm	HM30SGZ, HM30SZG
	62308	300cm x 109cm x 42W cm	HM35
	62362	320cm x 100cm x 38cm	HM20, HM205, HM20S, HM20SCG.2, HM20SG.2, HM20SMG.2
	62363	320cm x 100cm x 40cm	HM25
62367	320cm x 100cm x 44cm	HM30, HM30SCG.2	
62413	400cm x 72,5cm x 72W cm	AX40, AX40.2, AX40SR, AX40U, AX40UR.1, AX40UR.2, AX45, AX45.2, AX50, AX50.2, AX50SR, AX50U, AX50UCGL, AX55UR, AX55UR3, HM45, HM45.2, HM50, HM55	
62417	400cm x 72,5cm x 74KW cm	AX58MU	
62419	400cm x 72,5cm x 74W cm	AX58MU	
ANTEC	28329	180cm x 72cm x 37cm	HCC1051D
	28326	230cm x 72cm x 43cm	A12B, A145A
	62248	230cm x 72cm x 50cm	HCC2051
	62271	250cm x 72cm x 50cm	HCC2051
APAFOR	28326	230cm x 72cm x 43cm	30
ATEX	62211	180cm x 72cm x 33cm	500
	84523	200cm x 72cm x 38cm	XC750D

Brand	Art./Ref.	Misura/Size	Applicazione/Application
ATLAS	28335	180cm x 72cm x 34cm	CT045
	28329	180cm x 72cm x 37cm	1507, CT7NX
	28346	200cm x 72cm x 34cm	CT045
	62228	200cm x 72cm x 41cm	100, 100B, CT, CT100
	28332	230cm x 72cm x 41cm	110, 1104, CT, CT100, CT100R, CT150, CT150R, CT200R
	28327	230cm x 72cm x 42cm	120AB, CT120
	28326	230cm x 72cm x 43cm	120, 120RF, 404, 404R, CT10N, CT120, CT12N
	28331	230cm x 96cm x 33cm	404.2
	62271	250cm x 72cm x 50cm	1004
	62276	250cm x 72cm x 57cm	604, 604R
	62320	300cm x 52,5cm x 74W cm	CT27N
	62328	300cm x 52,5cm x 80N cm	CT30N
	62290	300cm x 109cm x 36W cm	CT27N
	62298	300cm x 109cm x 39N cm	CT30N
	62299	300cm x 109cm x 39W cm	604.2
	62362	320cm x 100cm x 38cm	CT230
	62364	320cm x 100cm x 41cm	360, 604, R604
	62365	320cm x 100cm x 42cm	1204C, 1204LC, 130LC, CT250, CT300
62366	320cm x 100cm x 43cm	804, 804R	
62437	450cm x 71cm x 86cm	805R	
ATN	62234	230cm x 48cm x 64cm	PIAF 450, PIAF 560
	62236	230cm x 48cm x 68cm	PIAF 800
	28360	230cm x 96cm x 32cm	PIAF 450
AUSA	28341	180cm x 60cm x 30cm	25CM
	62214	180cm x 72cm x 38cm	MH08
	28355	230cm x 72cm x 48cm	80CMA
AVANT TECNO	28334	230cm x 72cm x 45cm	DUMPER 1200
	62266	250cm x 72cm x 45cm	DUMPER 1500
BARALDI	28335	180cm x 72cm x 34cm	MINIDIG
	28329	180cm x 72cm x 37cm	MINIDIG
	28326	230cm x 72cm x 43cm	102, 102B, EB40, FB 1.02, FB 1.2, FB102
	28334	230cm x 72cm x 45cm	FB203
BARATTI	28329	180cm x 72cm x 37cm	SKORPIO
BARETTA	28335	180cm x 72cm x 34cm	T21
	28326	230cm x 72cm x 43cm	T41, T43, T45
BASTEI	28329	180cm x 72cm x 37cm	SLD151D
	62214	180cm x 72cm x 38cm	SLD151D
	62271	250cm x 72cm x 50cm	SLD251
BELLE	62226	200cm x 72cm x 37cm	5070
BENATI	28326	230cm x 72cm x 43cm	M13, M14
	62362	320cm x 100cm x 38cm	M22, M25
BENFRA	28326	230cm x 72cm x 43cm	9.01, 9.01B, 9.02S, 9.02
	84530	230cm x 72cm x 52cm	9.02B
BENNY	28326	230cm x 72cm x 43cm	SKORPIO 2C, SPIDER
BENTRAC	28334	230cm x 72cm x 45cm	M16
	62322	300cm x 52,5cm x 76N cm	M25
BERETTA	84522	200cm x 72cm x 36cm	T25
	62259	250cm x 52,5cm x 76N cm	T44
	62272	250cm x 72cm x 52cm	T45
	62322	300cm x 52,5cm x 76N cm	T46

Brand	Art./Ref.	Misura/Size	Applicazione/Application
<b>BERTANI</b>	<b>28334</b>	230cm x 72cm x 45cm	C-75
<b>BERTOLINI</b>	<b>62207</b>	180cm x 60cm x 38cm	BTR350, MINITRANSPORT
	<b>28335</b>	180cm x 72cm x 34cm	BTR500, BTR500D
<b>BOBCAT</b>	<b>62214</b>	180cm x 72cm x 38cm	316
	<b>62215</b>	180cm x 72cm x 39cm	E10, MT50, MT52
	<b>62228</b>	200cm x 72cm x 41cm	319
	<b>28326</b>	230cm x 72cm x 43cm	X119, X120, X122
	<b>28331</b>	230cm x 96cm x 33cm	322, 322G, 323, E322, X320 DELTA, X320E, X322, X322E
	<b>62266</b>	250cm x 72cm x 45cm	X220, X320, X322
	<b>62268</b>	250cm x 72cm x 47cm	X123
	<b>62319</b>	300cm x 52,5cm x 74N cm	X325, X328, X328E
	<b>62328</b>	300cm x 52,5cm x 80N cm	X231, X331, X331E, X334
	<b>62360</b>	300cm x 55cm x 88N cm	335, 430ZTS
	<b>84598</b>	320cm x 52,5cm x 74N cm	325D, 328D
	<b>84604</b>	320cm x 54cm x 82cm	303CR
	<b>84606</b>	320cm x 84cm x 46B cm	T140FINOOTT05
	<b>84607</b>	320cm x 86cm x 46B cm	T140DAOTT05
	<b>84608</b>	320cm x 86cm x 49B cm	T180, T190
	<b>62381</b>	320cm x 86cm x 52B cm	864, T190, T200
	<b>62362</b>	320cm x 100cm x 38cm	X125
	<b>62363</b>	320cm x 100cm x 40cm	X225
	<b>62409</b>	400cm x 72,5cm x 70W cm	X335
	<b>62417</b>	400cm x 72,5cm x 74KW cm	435ZTS, X337, X341
	<b>62419</b>	400cm x 72,5cm x 74W cm	435ZTS, X337, X341
	<b>62420</b>	400cm x 72,5cm x 76W cm	E60ZTS
<b>62434</b>	450cm x 71cm x 80cm	X445	
<b>62437</b>	450cm x 71cm x 86cm	442ZTS, X442	
<b>62447</b>	450cm x 81cm x 76W cm	E80ZTS	
<b>62455</b>	450cm x 86cm x 52cm	864, T190, T200	
<b>62456</b>	450cm x 86cm x 55cm	T250, T300, T320	
<b>BONNE ESPERANCE</b>	<b>28332</b>	230cm x 72cm x 41cm	MICROSAND
	<b>62268</b>	250cm x 72cm x 47cm	B23RP
	<b>62272</b>	250cm x 72cm x 52cm	BE2050, MINISAND
	<b>62366</b>	320cm x 100cm x 43cm	B35RP
<b>BORMOR</b>	<b>62250</b>	230cm x 72cm x 56cm	200TX, 400TX
<b>BOXER</b>	<b>28344</b>	180cm x 72cm x 36cm	TL224
<b>BROKK</b>	<b>84522</b>	200cm x 72cm x 36cm	100, 90, BM110, BM150, BM150C, BM150P
	<b>28327</b>	230cm x 72cm x 42cm	180
	<b>62250</b>	230cm x 72cm x 56cm	180
	<b>62253</b>	230cm x 96cm x 41cm	K330
	<b>62277</b>	250cm x 96cm x 41K cm	K330
	<b>62355</b>	300cm x 55cm x 78N cm	330
<b>CAMECA</b>	<b>62226</b>	200cm x 72cm x 37cm	BABY
<b>CAMISA</b>	<b>61551</b>	180cm x 60cm x 35cm	280, 380
	<b>28335</b>	180cm x 72cm x 34cm	580
	<b>62207</b>	180cm x 60cm x 38cm	480H
	<b>62227</b>	200cm x 72cm x 40cm	680
<b>CANYCOM</b>	<b>28342</b>	180cm x 60cm x 34cm	BFP401, BFP402, BFP405
	<b>28343</b>	180cm x 60cm x 37cm	BFP501, BFP602
	<b>62210</b>	180cm x 72cm x 31cm	BFP405, BFP411, BFP412, VFB405
	<b>62276</b>	250cm x 72cm x 57cm	1005



Brand	Art./Ref.	Misura/Size	Applicazione/Application
CARMIX	28326	230cm x 72cm x 43cm	K413, K414, K415
	62362	320cm x 100cm x 38cm	K425, K425.M
CARRIER	28341	180cm x 60cm x 30cm	HP250
	28342	180cm x 60cm x 34cm	HP250
	28343	180cm x 60cm x 37cm	HP250
	28346	200cm x 72cm x 34cm	HP400
	62226	200cm x 72cm x 37cm	HP500
	28340	200cm x 72cm x 42cm	1200, 1700X
CATERPILLAR	62201	150cm x 72cm x 33cm	ME05, MM05
	28344	180cm x 72cm x 36cm	ME08, ME08B, MM08B
	62235	230cm x 48cm x 66cm	189-0071
	28334	230cm x 72cm x 45cm	MS010
	28330	230cm x 96cm x 31cm	301.1, 301.5, 301.6, MM15T
	28331	230cm x 96cm x 33cm	301.6, 301.8, ME15, MH15, MM15
	62251	230cm x 96cm x 37cm	MX15
	62266	250cm x 72cm x 45cm	MS010
	62317	300cm x 52,5cm x 72W cm	MM25
	62320	300cm x 52,5cm x 74W cm	ME20, ME25, MM20, MM20CR, MM20SR, MM20T
	62323	300cm x 52,5cm x 76W cm	MM25, MM25T
	62336	300cm x 52,5cm x 84W cm	MM35, MM35B, MM35T, MM40SR, MX35
	62343	300cm x 52,5cm x 90W cm	303.5CCRV, 303CCR
	62290	300cm x 109cm x 36W cm	ME20, ME25
	62299	300cm x 109cm x 39W cm	ME30, ME35, MX35
	84602	320cm x 54cm x 76cm	302.5C
	84604	320cm x 54cm x 82cm	303.5
	62362	320cm x 100cm x 38cm	MS020
	62363	320cm x 100cm x 40cm	MS020, MXR30, NS020
	62366	320cm x 100cm x 43cm	MS020, MS030, MS035, MS30SR, MX30SR, MX35R, MXR30, MXR35, MXR35SR, NS030, NS035
	84616	380cm x 102cm x 42cm	247, 247B, 257, 257B
	62409	400cm x 72,5cm x 70W cm	ME40, ME45, MX45
	62413	400cm x 72,5cm x 72W cm	304, 304.5, 304CR, 305, 305CR, MM40B, MM40CR, MM40T, MM45, MM45B, MM45T, MM55SR, MM57SR, MX45
	62420	400cm x 72,5cm x 76W cm	305C, 305CCR
62430	400cm x 100cm x 52cm	MS040	
62431	420cm x 100cm x 54cm	MX50, MX55, MXR50, MXR55	
62435	450cm x 71cm x 82cm	307A, 307B, 307C, 307SSR, E70, E70B	
62438	450cm x 71cm x 88cm	308	
84650	460cm x 102cm x 51cm	267, 267B, 277, 277B, 277C, 287	
CELA	28326	230cm x 72cm x 43cm	TEL28
	62366	320cm x 100cm x 43cm	26, 28
	62373	320cm x 100cm x 52cm	560
CHIEFTAN	28329	180cm x 72cm x 37cm	7FX, IS07FX
	28326	230cm x 72cm x 43cm	10, 10G, 10S, 12G
	62367	320cm x 100cm x 44cm	IS33F, IS33X
	62369	320cm x 100cm x 46cm	IS35F
CHIKUSUI	62205	180cm x 60cm x 32cm	BFP301
	28342	180cm x 60cm x 34cm	BFP402, CC350
	28343	180cm x 60cm x 37cm	BFP602, CC450
	62210	180cm x 72cm x 31cm	BFP405
	28335	180cm x 72cm x 34cm	BFK 703, BFK 709, BFP 703, BFX 703, CC 500, CC 600, GC403/GG403
	28346	200cm x 72cm x 34cm	CANYCOM MINITRAC BFK709, CC500, CC600, D50, GC403
	28351	200cm x 72cm x 39cm	GC 41, GC 42
	28340	200cm x 72cm x 42cm	BFS 901Q, CC 700
	28327	230cm x 72cm x 42cm	BFK 808, BFS901Q, BFY 901, CC800 (VERSIONE 1)
	28326	230cm x 72cm x 43cm	403, CC300, CC800, GC403, GC50
	62247	230cm x 72cm 44cm	BFG1003, BFG1005, CC800, DUMPER, GC100, GC640, GC640R, GCS40
	28334	230cm x 72cm x 45cm	CC800, GC640

Brand	Art./Ref.	Misura/Size	Applicazione/Application
<b>CHIKUSUI</b>	<b>28358</b>	230cm x 72cm x 47cm	BFG1005
	<b>84530</b>	230cm x 72cm x 52cm	BFG1005
	<b>62266</b>	250cm x 72cm x 45cm	CC800, GC640
	<b>84590</b>	280cm x 72cm x 48cm	BFG1301, BFG1302, BFG1303, CC1300, CC1550
	<b>62385</b>	320cm x 90cm x 58cm	525A, BFY3301, SE3801
<b>CME</b>	<b>28327</b>	230cm x 72cm x 42cm	M12
	<b>28326</b>	230cm x 72cm x 43cm	M12, M15
<b>CASE NEW HOLLAND</b>	<b>62201</b>	150cm x 72cm x 33cm	H05
	<b>28344</b>	180cm x 72cm x 36cm	CK08
	<b>62216</b>	180cm x 72cm x 40cm	E09SR
	<b>62217</b>	180cm x 72cm x 40cm	E09SR
	<b>62232</b>	230cm x 48cm x 60cm	CK13, CK15
	<b>84526</b>	230cm x 48cm x 70K cm	516, CX14, CX16B, CX16SVC, CX16SVR, CX18B, E16, E16 EVOLUTION, E17, E18, E18 EVOLUTION, EH15B, EH18, HNK16C, NHK16R, NHK18C, NHK18R
	<b>62245</b>	230cm x 72cm x 39cm	TF300, TF300RT
	<b>62250</b>	230cm x 72cm x 56cm	6010 TURBO
	<b>28330</b>	230cm x 96cm x 31cm	15 FERMEC, 15 MAXI FERMEC, 16RTN-MAXI FERMEC, 8015, 8017, CK16, CX15STR, CX16
	<b>28331</b>	230cm x 96cm x 33cm	EC15
	<b>62256</b>	250cm x 52,5cm x 72K cm	E20SR, E22SR
	<b>62258</b>	250cm x 52,5cm x 76K cm	CX25, E25SR
	<b>62259</b>	250cm x 52,5cm x 76N cm	CX20B, CX20BMR, CX22B, E20.2SR, E22.2SR, NHK20SR3R, NHK22SR3C
	<b>84578</b>	250cm x 52,5cm x 80N cm	CX27, CX27B, CX27BMC, E27.2SR, EH27B, NHK25SR3C, NHK25SR3R
	<b>62316</b>	300cm x 52,5cm x 72N cm	CK25, CK28
	<b>62317</b>	300cm x 52,5cm x 72W cm	23MAXI, CX23
	<b>62322</b>	300cm x 52,5cm x 76N cm	CX22BZTS
	<b>62331</b>	300cm x 52,5cm x 82N cm	EH30B, NHK30SR3C, NHK30SR3R
	<b>62332</b>	300cm x 52,5cm x 82W cm	31, 31 MAXI, CK31, E30.2SR, E30SR
	<b>62336</b>	300cm x 52,5cm x 84W cm	CK36
	<b>62338</b>	300cm X 52,5cm X 86W cm	35, CX35
	<b>84595</b>	300cm x 52,5cm x 88K cm	CX36, CX36B, CX36BMC, CX36BMR, E35.2SR, E35SR, EH35B, NHK35SR3C
	<b>62352</b>	300cm x 55cm x 72N cm	EC25, EC25SR, EH20SR, EH25
	<b>62354</b>	300cm x 55cm x 76N cm	EH25SR
	<b>62355</b>	300cm x 55cm x 78N cm	CK32, EC35, EC35SR
	<b>62296</b>	300cm x 109cm x 38W cm	28, 28 MAXI, CK28, CX28
	<b>62302</b>	300cm x 109cm x 40W cm	31, 31MAXI, CK31, CX31
	<b>62305</b>	300cm x 109cm x 41W cm	CK36
	<b>62308</b>	300cm x 109cm x 42W cm	35
	<b>62377</b>	320cm x 54cm x 78N cm	CK32
	<b>84609</b>	320cm x 86cm x 50B cm	420CT
	<b>62396</b>	350cm x 56cm x 84W cm	CK38
	<b>62387</b>	350cm x 108cm x 42W cm	35, 35MAXI, 35STB, CK35
	<b>84615</b>	350cm x 108cm x 44cm	EH35, EH35SR
	<b>62412</b>	400cm x 72,5cm x 72N cm	CX50
	<b>62413</b>	400cm x 72,5cm x 72W cm	CK50, EC45, EC45SR
	<b>62417</b>	400cm x 72,5cm x 74KW cm	6060 TURBO
	<b>62419</b>	400cm x 72,5cm x 74W cm	6060 TURBO
	<b>62420</b>	400cm x 72,5cm x 76W cm	EC60
	<b>62423</b>	400cm x 74cm x 68N cm	CX40B, CX40BMC, CX40BMR, E40.2SR, E40SR, NH40SR3C
<b>62424</b>	400cm x 74cm x 72N cm	CX47, CX50B, CX50BMC, CX50BMR, E45.2SR, E45SR, E50.2SR, EH45, EH45SR, EH50B, NHK50SR3C	
<b>62434</b>	450cm x 71cm x 80cm	9007 ALLIANCE	
<b>62435</b>	450cm x 71cm x 82cm	9700CK	
<b>62439</b>	450cm x 73,5cm x 80cm	9700	
<b>62443</b>	450cm x 81cm x 72W cm	CK62	
<b>84632</b>	450cm x 81,5cm x 76cm	E70SR, E80, E80MSR, EH70	
<b>62456</b>	450cm x 86cm x 55cm	445CT, 450CT, LT185B, LT190B	
<b>COMECA</b>	<b>28344</b>	180cm x 72cm x 36cm	BAMBY 8

Brand	Art./Ref.	Misura/Size	Applicazione/Application
COMET	28335	180cm x 72cm x 34cm	CH2, CH3
	28329	180cm x 72cm x 37cm	MT13, MT13AB
	28327	230cm x 72cm x 42cm	MT13BB
	28326	230cm x 72cm x 43cm	3.01
COMET/IMECA	28329	180cm x 72cm x 37cm	13AB
	28340	200cm x 72cm x 42cm	MT13BB
	28327	230cm x 72cm x 42cm	MT13BB
	28326	230cm x 72cm x 43cm	3:01
CONJET	28355	230cm x 72cm x 48cm	322
CORMIDI	28343	180cm x 60cm x 37cm	50, 6,5
	28335	180cm x 72cm x 34cm	10.65 CARRIER, 13.80B, 5.65, 6.65, 65, 9.65 CARRIER, C.20.150 CARRIER
	28329	180cm x 72cm x 37cm	14.9, 9.65R
	62215	180cm x 72cm x 39cm	14.65
	28355	230cm x 72cm x 48cm	20.150, 23.150, C20.150
	84612	320cm x 86cm x 48T cm	C145
DAEWOO	28344	180cm x 72cm x 36cm	SOLAR 007
	28329	180cm x 72cm x 37cm	SOLAR 010, SOLAR 10
	28331	230cm x 96cm x 33cm	SOLAR 015, SOLAR 15, SOLARIS
	84571	230cm x 96cm x 35cm	SOLAR015PLUS, SOLAR018, SOLAR018VT
	62319	300cm x 52,5cm x 74N cm	SOLAR 25
	62322	300cm x 52,5cm x 76N cm	SOLAR030, SOLAR030PLUS, SOLAR30, SOLARDH30
	62328	300cm x 52,5cm x 80N cm	SOLAR 35
	62335	300cm x 52,5cm x 84N cm	SL035, SOLAR 035, SOLAR035PLUS
	62336	300cm x 52,5cm x 84W cm	DH35
	62289	300cm x 109cm x 36N cm	SOLAR 25
	62298	300cm x 109cm x 39N cm	AH30, SOLAR35
	62366	320cm x 100cm x 43cm	DSL702, SOLAR DSL702
	62417	400cm x 72,5cm x 74KW cm	DH50, SOLAR 55, SOLAR 55 V, SOLAR 55V PLUS, SOLAR DH50
	62419	400cm x 72,5cm x 74W cm	DH50, SOLAR55, SOLAR55V, SOLAR55VPLUS, SOLARDH50
	62420	400cm x 72,5cm x 76W cm	SOLAR55.3
62445	450cm x 81cm x 74W cm	SOLAR70, SOLAR75V	
DITCH WITCH	84515	180cm x 72cm x 32cm	SK300, SK350
	62215	180cm x 72cm x 39cm	JT520, SK500
	62245	230cm x 72cm x 39cm	HT25, JT1200, JT2511
	62250	230cm x 72cm x 56cm	920, 920L, JT820, JT920
	84571	230cm x 96cm x 35cm	MX182
	84577	250cm x 52,5cm x 78N cm	MX202
	62266	250cm x 72cm x 45cm	XT850
	62275	250cm x 72cm x 56cm	JT3510
	84592	280cm x 72cm x 56cm	JT1220, JT1720
	84593	300cm x 52,5cm x 92N cm	JT2320, JT2520, JT2720
	62346	300cm x 52,5cm x 98N cm	JT2720ALL
	62422	400cm x 72,5cm x 82W cm	JT4020
	62438	450cm x 71cm x 88cm	HT115, JT7020
DOOSAN	62328	300cm x 52,5cm x 80N cm	DX27Z
	62335	300cm x 52,5cm x 84N cm	DX30Z
	62337	300cm x 52,5cm x 86N cm	DX35Z
	62420	400cm x 72,5cm x 76W cm	DX60R
	62447	450cm x 81cm x 76W cm	DX80R
DRAGO	28326	230cm x 72cm x 43cm	DRAGO SWISS
DYNAPAC	28334	230cm x 72cm x 45cm	D15, FC15, VD15
	28357	230cm x 72cm x 46cm	RT1000, RT80
	28331	230cm x 96cm x 33cm	VD151

Brand	Art./Ref.	Misura/Size	Applicazione/Application
<b>DYNAPAC</b>	<b>62266</b>	250cm x 72cm x 45cm	D15, FC15, VC15, VD15
	<b>62319</b>	300cm x 52,5cm x 74N cm	VD251
	<b>62289</b>	300cm x 109cm x 36N cm	VD251
	<b>62363</b>	320cm x 100cm x 40cm	VD25, X1
	<b>62366</b>	320cm x 100cm x 43cm	CD35, VD30
<b>EAGLE TRAX</b>	<b>28363</b>	230cm x 96cm x 39cm	TRAX 40
<b>ECKART</b>	<b>28335</b>	180cm x 72cm x 34cm	1 B30, EMB450B
<b>ECOMAT</b>	<b>28326</b>	230cm x 72cm x 43cm	650S, EB10, EB10.4, EB11, EB12, EB12.4, EB14, EB14.2, EB14.4, EB150XR, EB271, EC14, EC15BXR, SIRIUS
	<b>28334</b>	230cm x 72cm x 45cm	EB14, EB14.4, EB16.4
	<b>28358</b>	230cm x 72cm x 47cm	EB11, EB16, EB16.4, EB16.5
	<b>28331</b>	230cm x 96cm x 33cm	EB150, EB150XR, EB150XT, EB150XTV, EC13, EC15, EC15B, EC15XR
	<b>62266</b>	250cm x 72cm x 45cm	EB14, EB14.4, EB16.4
	<b>62268</b>	250cm x 72cm x 47cm	EB11, EB16, EB16.4, EB16.5
	<b>84579</b>	250cm x 96cm x 36cm	EB200, EB200XT, EB200XTV, EB263, EC20, EC20B, EC20BXTV
	<b>62317</b>	300cm x 52,5cm x 72W cm	EB22.4, EB25.4, EB28.4, EB30.4
	<b>62336</b>	300cm x 52,5cm x 84W cm	EB25.4, EB28, EB28.4, EB306, EB350, EB36, EB400, EB406, EC35, LS200, LS2000, LS286, LS386, LS406
	<b>62287</b>	300cm x 109cm x 35W cm	EB22.4, EB25.4, EB28.4, EB30.4
	<b>62296</b>	300cm x 109cm x 38W cm	EB250, EB300, EB350, EC25, EC30, EC300
	<b>62305</b>	300cm x 109cm x 41W cm	EB25.4, EB28, EB28.4, EB306, EB350, EB36, EB400, EB406, EC35, LS200, LS2000, LS286, LS3864, LS406
	<b>62362</b>	320cm x 100cm x 38cm	EB22, EB27, Y22
	<b>62366</b>	320cm x 100cm x 43cm	EB36
	<b>62406</b>	400cm x 72,5cm x 68W cm	EB450, EC45
	<b>62413</b>	400cm x 72,5cm x 72W cm	EB506
	<b>62417</b>	400cm x 72,5cm x 74KW cm	EC55, EC55B
<b>62419</b>	400cm x 72,5cm x 74W cm	EC55, EC55B	
<b>62434</b>	450cm x 71cm x 80cm	EB706, EC70	
<b>ELEKTRO JOE</b>	<b>28335</b>	180cm x 72cm x 34cm	ECOJOLLY
<b>EMCI</b>	<b>84523</b>	200cm x 72cm x 38cm	SILEA
	<b>62373</b>	320cm x 100cm x 52cm	INOVA
<b>ETEC</b>	<b>62362</b>	320cm x 100cm x 38cm	25
<b>EUROCAT</b>	<b>28326</b>	230cm x 72cm x 43cm	140HVS, 140LSE, 150LSE
	<b>62266</b>	250cm x 72cm x 45cm	210HVS
	<b>62271</b>	250cm x 72cm x 50cm	200LSE, 210HVS, 210LSE, 250LSE
	<b>62298</b>	300cm x 109cm x 39N cm	350SLE
	<b>62367</b>	320cm x 100cm x 44cm	350SLE
<b>EUROCOMACH</b>	<b>28335</b>	180cm x 72cm x 34cm	E800, ES80, ES90
	<b>28346</b>	200cm x 72cm x 34cm	ES90
	<b>62226</b>	200cm x 72cm x 37cm	E1300, ES90
	<b>62234</b>	230cm x 48cm x 64cm	E1500S
	<b>62239</b>	230cm x 48cm x 74cm	ES250
	<b>28326</b>	230cm x 72cm x 43cm	E 1200, E 1500, E 1500SB, E1300, E1550S, ES150, ES150.2, ES180, ES180.2
	<b>28360</b>	230cm x 96cm x 32cm	E1500, E1500S, ES180.2
	<b>28331</b>	230cm x 96cm x 33cm	ES150, ES150.1, ES150.2, ES180
	<b>84571</b>	230cm x 96cm x 35cm	ES180SR, ESW180SR
	<b>84575</b>	230cm x 101cm x 31cm	E1500
	<b>62319</b>	300cm x 52,5cm x 74N cm	ES300
	<b>62331</b>	300cm x 52,5cm x 82N cm	ES350ZT
	<b>62335</b>	300cm x 52,5cm x 84N cm	ES400, ES400SR, ES400ZT
	<b>62352</b>	300cm x 55cm x 72N cm	ES300
	<b>62364</b>	320cm x 100cm x 41cm	E2500
<b>62413</b>	400cm x 72,5cm x 72W cm	ES500, ES500ZT	
<b>EURODIG</b>	<b>28342</b>	180cm x 60cm x 34cm	DUMPY 300, DUMPY 800
	<b>62208</b>	230cm x 96cm x 36cm	DUMPY 500

Brand	Art./Ref.	Misura/Size	Applicazione/Application
EURODIG	28335	180cm x 72cm x 34cm	800, DUMPY 500-2, G 500, GR 500, GR 700
	28329	180cm x 72cm x 37cm	DUMPY 800-2, MINIDIG1000, MINIDIG700
	62226	200cm x 72cm x 37cm	DUMPY 500, DUMPY 800P, GR1000, GR700A, GR700A3, GR700D, GR900, MINILOAD 800
	84530	230cm x 72cm x 52cm	MINILIFT C18
	62251	230cm x 96cm x 37cm	TS20
	62272	250cm x 72cm x 52cm	C15, C18, MINLIFT C18
EUROTOM	28331	230cm x 96cm x 33cm	TS15, TS15S, TS17SE
	62251	230cm x 96cm x 37cm	TS20
	62319	300cm x 52,5cm x 74N cm	TS27S
	62328	300cm x 52,5cm x 80N cm	TS30R
	62331	300cm x 52,5cm x 82N cm	TS35
	62352	300cm x 55cm x 72N cm	TS25
	62355	300cm x 55cm x 78N cm	ME1400H, NB30, TS30, TS30R, TS35, TS35S
	62409	400cm x 72,5cm x 70W cm	TS45
	62413	400cm x 72,5cm x 72W cm	TS45
62437	450cm x 71cm x 86cm	TS75, TS75S	
FAI	28326	230cm x 72cm x 43cm	212
	28330	230cm x 96cm x 31cm	212, 215, 218
	84574	230cm x 101cm x 30cm	212, 215, 218
	62291	300cm x 109cm x 37K cm	220, 222, 225, 226
	62300	300cm x 109cm x 40K cm	232
	62303	300cm x 109cm x 41K cm	230, 235, 240
	62368	320cm x 100cm x 45cm	230ALT
	62402	400cm x 142cm x 37K cm	245, 250
FERCAD	28342	180cm x 60cm x 34cm	T3250
	84513	180cm x 60cm x 36cm	T6350
FERMEC	28330	230cm x 96cm x 31cm	MF 114, MF 115, SK015
	62332	300cm x 52,5cm x 82W cm	MF130, MF131, SK030
	62338	300cm X 52,5cm X 86W cm	135, SK035
	62296	300cm x 109cm x 38W cm	128, MF125, MF128, SK025
	62302	300cm x 109cm x 40W cm	MF130, MF131, SK030
	62308	300cm x 109cm x 42W cm	135
	62387	350cm x 108cm x 42W cm	MF135, SK035
	62417	400cm x 72,5cm x 74KW cm	145, 150
	62419	400cm x 72,5cm x 74W cm	145, 150
FIAT HITACHI	28330	230cm x 96cm x 31cm	FH 15.2, FH 15.2 PLUS, FH15
	28331	230cm x 96cm x 33cm	FH 16.2, FH 17.2, FH 17.2 PLUS, FH16.2 PLUS, FH17.2B
	62257	250cm x 52,5cm x 73N cm	FH22, FH22.2
	62319	300cm x 52,5cm x 74N cm	FH22, FH22.2, FH22PLUS
	62331	300cm x 52,5cm x 82N cm	FH30.2, FH35.2
	62356	300cm x 55cm x 80N cm	EX30U, EX33U, FH30.2PLUS, FH35.2, FH35.2PLUS, SH30.2
	62413	400cm x 72,5cm x 72W cm	FH40.2, FH40.2PLUS, FH45.2
FIORI	28346	200cm x 72cm x 34cm	MD07
FOREDIL	28334	230cm x 72cm x 45cm	FM16, FM18V, FM19RSV, FM19VR
	62352	300cm x 55cm x 72N cm	FM24
	62355	300cm x 55cm x 78N cm	FM29, FM34
	62413	400cm x 72,5cm x 72W cm	FM54
FORT	62207	180cm x 60cm x 38cm	MINIDUMPER
FRASTE	28335	180cm x 72cm x 34cm	TERRAIN
	28326	230cm x 72cm x 43cm	PL
	28363	230cm x 96cm x 39cm	ML
	62272	250cm x 72cm x 52cm	ML
	62357	300cm x 55cm x 82N cm	XL

Brand	Art./Ref.	Misura/Size	Applicazione/Application
<b>FURUKAWA</b>	28344	180cm x 72cm x 36cm	FX007, FX008
	28329	180cm x 72cm x 37cm	FX007, FX008, FX008.2
	62216	180cm x 72cm x 40cm	UX10
	28340	200cm x 72cm x 42cm	FX012
	62232	230cm x 48cm x 60cm	FX012, FX012.1, FX013.2, FX014, FX015.2
	28327	230cm x 72cm x 42cm	FX012, FX014
	28358	230cm x 72cm x 47cm	
	62336	300cm x 52,5cm x 84W cm	FX042UR, UX30, UX35
	62357	300cm x 55cm x 82N cm	FX301UR
	62305	300cm x 109cm x 41W cm	FX042UR, UX30, UX35
	62413	400cm x 72,5cm x 72W cm	FX040, FX040.2, FX045, FX045.1, FX045.2, FX50URG, FX55UR, FX55UR.2, UX45
	62417	400cm x 72,5cm x 74KW cm	FX052UR, FX58MU
	62419	400cm x 72,5cm x 74W cm	FX052UR, FX58MU
	62420	400cm x 72,5cm x 76W cm	FX055, FX55
	62443	450cm x 81cm x 72W cm	FX60.2, FX60.3, FX60URG
62447	450cm x 81cm x 76W cm	FX75UR	
<b>G&amp;D ITALIA</b>	28329	180cm x 72cm x 37cm	HCC1051D
<b>GEHL</b>	28327	230cm x 72cm x 42cm	GX10
	28365	230cm x 96cm x 36cm	153
	84580	250cm x 96cm x 38cm	193, 223
	62296	300cm x 109cm x 38W cm	303
	62299	300cm x 109cm x 39W cm	363
	84612	320cm x 86cm x 48T cm	CTL60
	84613	320cm x 86cm x 52T cm	4640, CTL60
	62367	320cm x 100cm x 44cm	GX30
	62413	400cm x 72,5cm x 72W cm	GX35
	62417	400cm x 72,5cm x 74KW cm	502
	62419	400cm x 72,5cm x 74W cm	502
	62436	CINGOLO GOMMA 450 X 71 X 84	802
62432	450cm x 100cm x 50cm	CTL80	
<b>GEHLMAX</b>	28344	180cm x 72cm x 36cm	M045, MB045
	62227	200cm x 72cm x 40cm	DR600
	62238	230cm x 48cm x 72cm	GE222
	28326	230cm x 72cm x 43cm	A12, A12B, A14SA, M135, M135S, MB138, MB148
	28334	230cm x 72cm x 45cm	M135, MB1135S, MB145, MB165
	84530	230cm x 72cm x 52cm	RD15D, RD15DR
	28365	230cm x 96cm x 36cm	GE222
	62266	250cm x 72cm x 45cm	M135, MB1135, MB1135S, MB145, MB165
	62325	300cm x 52,5cm x 78N cm	MB288
	62335	300cm x 52,5cm x 84N cm	MB358
	62305	300cm x 109cm x 41W cm	353, 373
	62377	320cm x 54cm x 78N cm	GE342
	62362	320cm x 100cm x 38cm	A250SA
	62363	320cm x 100cm x 40cm	MB135, MB135S, MB245
	62370	320cm x 100cm x 48cm	MB435, MB445
<b>GEOTOOL</b>	28343	180cm x 60cm x 37cm	GEOTOOL
<b>GRILLO</b>	28342	180cm x 60cm x 34cm	DUMPER 350
	28335	180cm x 72cm x 34cm	DUMPER 350HD, DUMPER 507
<b>HANIX</b>	62201	150cm x 72cm x 33cm	H05
	62214	180cm x 72cm x 38cm	H08B, N050, N080, N080.2LR
	62239	230cm x 48cm x 74cm	H22B
	28326	230cm x 72cm x 43cm	N 150, N 150 R, N120, N120R
	28334	230cm x 72cm x 45cm	N120R, N6, RK15
	28357	230cm x 72cm x 46cm	100B3, RT100, RT100B3, RT100D3, RT80
	62248	230cm x 72cm x 50cm	YFW5D.1

Brand	Art./Ref.	Misura/Size	Applicazione/Application
HANIX	28330	230cm x 96cm x 31cm	H12A, H15, H15A, H15B, H15B PLUS
	28331	230cm x 96cm x 33cm	150N, H15, H15.1, H15A, H15B PLUS.2, H15B.2, N120.2, N150.2, N150.2R
	62251	230cm x 96cm x 37cm	NS20, S&B150, S&B150.2
	62266	250cm x 72cm x 45cm	N06, N060, N120, N120R, N6, RK15
	62271	250cm x 72cm x 50cm	YFW5D.1
	62319	300cm x 52,5cm x 74N cm	H22A, H24, H27, N230.2, N230.2R, N250.2, N260.2, N26B, NS25
	62328	300cm x 52,5cm x 80N cm	N300.2, N300.2R, N350.2, S&B300, S&B300.2
	62335	300cm x 52,5cm x 84N cm	H36CR
	62352	300cm x 55cm x 72N cm	H22, H24A, H25B, H26B, H27.2
	62355	300cm x 55cm x 78N cm	H29A, H30, H30.2, H30A
	62357	300cm x 55cm x 82N cm	H36B
	62289	300cm x 109cm x 36N cm	230.2, 230.2R, 250.2, 260.2, H24, H27, NS25
	62298	300cm x 109cm x 39N cm	H35, H35A, H36A, N300.2, N300.2R, N350.2, N350.2R, S&B300, S&B300.2
	62299	300cm x 109cm x 39W cm	N35
	62362	320cm x 100cm x 38cm	N219, N220, N220R, N220RC18, N250, N250R, N250RC18
	62363	320cm x 100cm x 40cm	N15, N20, N220, N220R, N250, N250R, N300, N300R, N350R, S&B1, S&B12, S&B12R, S&B15R, S&B15S, S&B15SR, S&B20, S&B20S, S&B20SR, S&BX.1, S&B15RC, X1
	62366	320cm x 100cm x 43cm	N15, N20, N220R, N250, N250R, N300, N300R, N320, N350, N350.2, N350R, N350R2, N350RH, S&B1, S&B115, S&B15, S&B15R, S&B15RC, S&B15S, S&B15SR, S&B20, S&B20.5, S&B20R, S&B20S, S&B20SR, S&B220
	62409	400cm x 72,5cm x 70W cm	H45, H45A, N400.2, N450.2, N450.2R, S&B480
	62413	400cm x 72,5cm x 72W cm	H50B, H50C, H56C, N400.2, N450.2, N450.2R, S&B480
	62417	400cm x 72,5cm x 74KW cm	S&B25.1, S&B25.2
	62419	400cm x 72,5cm x 74W cm	S&B25.1, S&B25.2
	62430	400cm x 100cm x 52cm	N450, N450R, N550.2
	62431	420cm x 100cm x 54cm	N550.2, S&B225, S&B25, S&B25R, S&B25S, S&B30, S&B30R, S&B30S, S&B330, S&B500, S&B550, S&B580
62437	450cm x 71cm x 86cm	H75B, H75C	
62449	450cm x 81cm x 78W cm	S&B800, S&B800.2	
84640	450cm x 90cm x 58cm	RT400, RT400E1	
HANIX NISSAN	28344	180cm x 72cm x 36cm	H 08, H 08-2, N 80, N 80-2, N 80-2R, RT30, S&B08
	28329	180cm x 72cm x 37cm	H08.1, H08A, H80, H80.2, N 080, N 080-3LR, RT30
	28331	230cm x 96cm x 33cm	N 120-2, N 150-2, VD 151
HANTA	28329	180cm x 72cm x 37cm	SLD151D
	62271	250cm x 72cm x 50cm	SLD251D
HAULOTTE	62276	250cm x 72cm x 57cm	PLATFORM
HCC	28343	180cm x 60cm x 37cm	1051D
	28329	180cm x 72cm x 37cm	1050, 1050B, 1051D
	62271	250cm x 72cm x 50cm	2051
HITACHI	28344	180cm x 72cm x 36cm	EX7
	28329	180cm x 72cm x 37cm	AX08, EG08, EX 7, EX 8, EX 8.1, EX 8.2, EX 8.2B, ZX8.2
	62213	180cm x 72cm x 37cm	ZX8.2
	62216	180cm x 72cm x 40cm	EX10U, EX10UX
	84516	180cm x 72cm x 41K cm	ZAXIS 10U2
	28327	230cm x 72cm x 42cm	EX 14, EX12, EX14SR, HE 10, ME 15S, ME15S, UE 004, UE 10, UE 12, UE 15, UE 15 SR
	28326	230cm x 72cm x 43cm	UE15, UE15SR
	28357	230cm x 72cm x 46cm	CG8
	28330	230cm x 96cm x 31cm	EX 12, EX 15, EX 15-2, EX12.2, EX15.1, EX15U, EX16, SH 15-2
	28331	230cm x 96cm x 33cm	EX 17-2, EX15U, EX16, EX17, EX17.2B, HE 15, ME15, ZAXIS15, ZAXIS16, ZAXIS18, ZX16.3, ZX18, ZX18YLR
	84571	230cm x 96cm x 35cm	EX15UR, EX17U, ZX17, ZX17U.2
	62257	250cm x 52,5cm x 73N cm	EX18.2, EX20.2, EX22, EX22.1, EX22.2, ZAXIS 25, ZX25
	62259	250cm x 52,5cm x 76N cm	EX20U.3, EX20UR, EX20UR.1, EX20UR.3
	62260	250cm x 52,5cm x 77N cm	ZX22U.2
	84577	250cm x 52,5cm x 78N cm	EX20UR, EX20UR.2C
	62277	250cm x 96cm x 41K cm	EX20U, EX20U.1
	62316	300cm x 52,5cm x 72N cm	EX21, EX24
	62322	300cm x 52,5cm x 76N cm	EX25, EX25.1, EX25.2, EX26, EX27, EX30UR
	62325	300cm x 52,5cm x 78N cm	EX27U, EX29U

Brand	Art./Ref.	Misura/Size	Applicazione/Application
HITACHI	62328	300cm x 52,5cm x 80N cm	EX27.U2, ZX27U.2
	62331	300cm x 52,5cm x 82N cm	E33U, EX30, EX30.1, EX30.2, EX30UR, EX30UR.3, EX32U, EX32UE, EX33MU, EX35.2, ZAXIS 30, ZAXIS 35, ZX30
	62335	300cm x 52,5cm x 84N cm	EX33, EX35.1, UE30
	62337	300cm x 52,5cm x 86N cm	EX35U, EX36U, EX40UR.3, UE35, ZAXIS 30U2, ZAXIS 35U3, ZX30U.2
	62353	300cm x 55cm x 74N cm	EX30UR.1, EX30UR.2
	62357	300cm x 55cm x 82N cm	EX35, EX40UR, EX40UR.1, EX40UR.2, EX40URG
	62286	300cm x 109cm x 35N cm	EX24, UE20
	62289	300cm x 109cm x 36N cm	FH22, FH22.2, FH22PLUS
	62292	300cm x 109cm x 37N cm	EX25, EX26, EX27
	62304	300cm x 109cm x 41N cm	EX33
	62362	320cm x 100cm x 38cm	HM20, UE20
	62363	320cm x 100cm x 40cm	HM25, UE25
	62367	320cm x 100cm x 44cm	UE30
	62413	400cm x 72,5cm x 72W cm	EX40.1, EX40.2, EX40.2PLUS, EX40U, EX45.2, EX45U, EX50.1, EX50.2, EX50URG/3, EX55UR, UE40, UE45, UE50, ZAXIS40, ZAXIS50, ZX40, ZX50U, ZX55U
	62418	400cm x 72,5cm x 74N cm	ZAXIS40U2, ZAXIS50U2
	62420	400cm x 72,5cm x 76W cm	EX55, EX55/1, EX55/2, EX55/3
	62443	450cm x 81cm x 72W cm	EX60.3/2, EX75UR/3
	62444	450cm x 81cm x 74N cm	ZX70.4
	62447	450cm x 81cm x 76W cm	EX70UR, EX75UR.3/2, EX75UR/4, ZAXIS 85USBLC
	62448	450cm x 81cm x 78N cm	EX60LC.5
84631	450cm x 81,5cm x 74cm	EX60.5, EX80, ZAXIS 70, ZAXIS80SB, ZX70, ZX80	
84632	450cm x 81,5cm x 76cm	EX60LC.3/1, EX60URG.2/1, EX75UR.3/1	
84633	450cm x 81,5cm x 78cm	EX70U, EX75UR.5, EX75US.7, ZAXIS 70LC, ZAXIS 75US.3, ZX70LC, ZX75US3	
HOKUETSU	28344	180cm x 72cm x 36cm	HM07S, HM07SG
	28331	230cm x 96cm x 33cm	HM10, HM15
	62362	320cm x 100cm x 38cm	HM20, HM20S, HM20SCG.2, HM20SG.2, HM20SMG.2, HM20SOG.2
	62363	320cm x 100cm x 40cm	HM25
	62367	320cm x 100cm x 44cm	HM30, HM30SCG.2, HM30SG.2, HM30SMG.2, HM30SOG.2
HOLMAC	62226	200cm x 72cm x 37cm	HM200, HZC16, HZC22
	28326	230cm x 72cm x 43cm	HZC20, HZC26, HZC292X, R13700
HOLMED	84522	200cm x 72cm x 36cm	HOLMED
HONDA	28341	180cm x 60cm x 30cm	B114, HP250, HP300
	28342	180cm x 60cm x 34cm	HP250, HP350, SC 156 DD
	28343	180cm x 60cm x 37cm	B415, HP250, HP400 CARRIER, HP450, HP500 CARRIER
	28335	180cm x 72cm x 34cm	HP400, HP800A
	28346	200cm x 72cm x 34cm	HP400
	62199	200cm x 72cm x 35cm	SC433
	62226	200cm x 72cm x 37cm	HP500
HUKI	28335	180cm x 72cm x 34cm	GT33
	28346	200cm x 72cm x 34cm	50, 60, 60D, D50
	28327	230cm x 72cm x 42cm	80 B.4
	62247	230cm x 72cm 44cm	100, 640R, DUMPER, GL640
	28355	230cm x 72cm x 48cm	100H-R, 130
HUTTER	28346	200cm x 72cm x 34cm	60H
	28327	230cm x 72cm x 42cm	80H
	28326	230cm x 72cm x 43cm	14G2
	28355	230cm x 72cm x 48cm	HR100
	62248	230cm x 72cm x 50cm	110H, 120H
	62276	250cm x 72cm x 57cm	HBR202TF
HYDRA	62207	180cm x 60cm x 38cm	9.2
	28326	230cm x 72cm x 43cm	JOY 1
	62272	250cm x 72cm x 52cm	JOY2
HYDRAMAC	28326	230cm x 72cm x 43cm	C 4200, H 15



Brand	Art./Ref.	Misura/Size	Applicazione/Application
HYDRORAIN	62211	180cm x 72cm x 33cm	X400Y, X400YD, X500YD
	28357	230cm x 72cm x 46cm	X1000DH3
HYUNDAI	62239	230cm x 48cm x 74cm	ROBEX 22.7
	62319	300cm x 52,5cm x 74N cm	ROBEX28.5, ROBEX28.7
	62335	300cm x 52,5cm x 84N cm	ROBEX35.5
	62337	300cm x 52,5cm x 86N cm	ROBEX 35Z7
	62355	300cm x 55cm x 78N cm	ROBEX 30
	62420	400cm x 72,5cm x 76W cm	ROBEX55.3, ROBEX55.7
	62437	450cm x 71cm x 86cm	ROBEX75.7
IBEA	62205	180cm x 60cm x 32cm	250
	28342	180cm x 60cm x 34cm	IBEA, IBT350
	28343	180cm x 60cm x 37cm	IBF 300, IBF 500D, IBF 500DH, IBT500
IHI	28343	180cm x 60cm x 37cm	CC450
	62210	180cm x 72cm x 31cm	316
	62211	180cm x 72cm x 33cm	4J, IS4F, IS4FG, IS4FX, IS4GX, IS4GX3, IS4J
	28335	180cm x 72cm x 34cm	102, 105 CARRY
	28329	180cm x 72cm x 37cm	102R, 103, 9NX, IS 7 F, IS 7 FX, IS 7 GX, IS 7 GX2, IS 7 GX3, IS 7 J, IS 7 P, IS07, IS07FP, IS07FX
	28346	200cm x 72cm x 34cm	CC600
	62228	200cm x 72cm x 41cm	IS9UX
	62234	230cm x 48cm x 64cm	15, 15J, 16N, 17J, 17JE, 17NE, IS15J, IS16N, IS17J, IS17JE
	62242	230cm x 48cm x 80cm	20JX, 20NX, 20Z, IS18UJ, IS20JX
	28332	230cm x 72cm x 41cm	
	28327	230cm x 72cm x 42cm	CC800
	28326	230cm x 72cm x 43cm	IS 10 C, IS 10 F, IS 10 FX, IS 10 G, IS 10 GX, IS 10 S, IS 12 C, IS 12 G, IS 12 GX, IS 14 G, IS 14 GX, IS 14 PX, IS11X, IS12, IS12S, IS14, IS14.3, IS14GX2, IS14GX3
	28358	230cm x 72cm x 47cm	10 Z, 12 JX, 12J, 9JX, IS 9 UX-2, IS10Z, IS12JX, IS12NX, IS9UX3
	84528	230cm x 72cm x 47Y cm	12JX, IS12JX
	84530	230cm x 72cm x 52cm	MC15
	28360	230cm x 96cm x 32cm	15, 16N, 17NE, IMER 15 J, IMER 17 J, IMER 17 JE, IS15J, IS16N, IS17J, IS17JE
	84571	230cm x 96cm x 35cm	15NX, 17VXE, 18J, 18N, 18NXT, IS16J, IS18J
	28364	230cm x 96cm x 40cm	
	62268	250cm x 72cm x 47cm	IS10Z, IS12NX
	84581	250cm x 96cm x 40cm	20JX, 20NX, 20Z, IS18UJ, IS20JX
	84590	280cm x 72cm x 48cm	CC1500
	62317	300cm x 52,5cm x 72W cm	25J, IS25G, IS25GX, IS25J
	62323	300cm x 52,5cm x 76W cm	25JX, 28J, IS25JX, IS25NX, IS27, IS27G, IS27GX, IS28, IS28G, IS28G3, IS28GX, IS28J, IS28JX, IS28LX, IS28PX
	62325	300cm x 52,5cm x 78N cm	25NX.2
	62336	300cm x 52,5cm x 84W cm	30JX, 30NX, 35J, 35N, GX35, IS30JX, IS30NX, IS32J, IS35G, IS35G.1, IS35G.2, IS35GX, IS35GX.1, IS35GX.3, IS35J
	62343	300cm x 52,5cm x 90W cm	35FX, 35JX, 35N, 35NX, 35UJ, 40Z, CCH30T, IS35JX, IS35NX, IS35UJ, IS38UJ, IS40Z
	62287	300cm x 109cm x 35W cm	IS25GX, IS25J
	62293	300cm x 109cm x 37W cm	IS25JX, IS27, IS27G, IS27GX, IS28, IS28G, IS28GX, IS28J, IS28JX, IS28LX, IS28PX
	62299	300cm x 109cm x 39W cm	22UX, 28UX, 30S, IS28UX, IS28UX.2, IS30G, IS30GX, IS30GX.2, IS30J, IS30UJ, IS30UJ.2, IS30Z, IS38UX
	62305	300cm x 109cm x 41W cm	IS32J, IS35G, IS35G.1, IS35G.2, IS35GX, IS35GX.1, IS35GX.2, IS35GX.3, IS35J
	62385	320cm x 90cm x 58cm	IC30
	62362	320cm x 100cm x 38cm	IS25S, IS25S.2
	62363	320cm x 100cm x 40cm	IS27F, IS27FX, IS27R
	62367	320cm x 100cm x 44cm	IS30F, IS30FX
	62369	320cm x 100cm x 46cm	IS33SX, IS35F, IS35FX, S33FX
	62387	350cm x 108cm x 42W cm	T840
	62409	400cm x 72,5cm x 70W cm	IS40G, IS40GX, IS40GX.2, IS40J
	62412	400cm x 72,5cm x 72N cm	45J, 45J.2, 45NX.2, 45UJ, IS45J
	62413	400cm x 72,5cm x 72W cm	40NX, 50NX, IS40JX, IS40NX, IS45J.2, IS45N, IS45NX, IS45UJ, IS55U.1, IS55U.2
	62417	400cm x 72,5cm x 74KW cm	55J, 55J2, 55N, 55UX, IS50G, IS50G3, IS50GX, IS50UJ, IS50UX, IS50Z, IS55G, IS55G.3, IS55J, IS55J.2, IS55LX, IS55N, IS55UJ, IS55UX
	62419	400cm x 72,5cm x 74W cm	50UX, 55J, 55J2, 55N, IS50G, IS50G3, IS50GX, IS50UJ, IS50UX, IS50Z, IS55G, IS55G.3, IS55J, IS55J.2, IS55LX, IS55N, IS55UJ, IS55UX
	62422	400cm x 72,5cm x 82W cm	65NX

Brand	Art./Ref.	Misura/Size	Applicazione/Application
IHI	62435	450cm x 71cm x 82cm	65UJ, 70Z, 75NX, 75UJ, 80NX, IS65UJ, IS70Z, IS75UJ, IS80, IS80NX
	62439	450cm x 73,5cm x 80cm	70J
	62440	450cm x 73,5cm x 86cm	75UJ
IMECA	28329	180cm x 72cm x 37cm	CHASSIS M13
IMEF	28335	180cm x 72cm x 34cm	HT 6.01
	28326	230cm x 72cm x 43cm	HE1.15, HE12, HE14, HE14S, HE16, HE16S
	28355	230cm x 72cm x 48cm	1.18, HE18, HE18S, HE18S
	62251	230cm x 96cm x 37cm	HE2.22
	62362	320cm x 100cm x 38cm	HE24
	62366	320cm x 100cm x 43cm	HE2.30, HE230, HE38
	84615	350cm x 108cm x 44cm	HE230
IMER	62210	180cm x 72cm x 31cm	316
	28335	180cm x 72cm x 34cm	105 CARRY
	28329	180cm x 72cm x 37cm	103, 9NX.3, IS 7 GX, IS 7 J
	62226	200cm x 72cm x 37cm	107 CARRY
	62234	230cm x 48cm x 64cm	15J, 16N, 17J, 17JE, 17NE
	62242	230cm x 48cm x 80cm	20JX, 20NX, 20Z
	28358	230cm x 72cm x 47cm	10Z, 12J, 12JX, 9JX
	84528	230cm x 72cm x 47Y cm	12J, 12JX
	28355	230cm x 72cm x 48cm	CC100, CC1000
	28360	230cm x 96cm x 32cm	14NXT, 15J, 15NXT, 16N, 16NX, 17J, 17JE, 17NE
	84571	230cm x 96cm x 35cm	15NX, 16NXT, 17NXT, 17VXE, 18, 18J, 18N, 18NXT
	62268	250cm x 72cm x 47cm	10Z, 9JX
	84581	250cm x 96cm x 40cm	20JX, 20NX, 20Z
	62317	300cm x 52,5cm x 72W cm	25J
	62323	300cm x 52,5cm x 76W cm	25JX, 28J
	62325	300cm x 52,5cm x 78N cm	25NX.2
	62336	300cm x 52,5cm x 84W cm	30JX, 30NX, 30NX.2, 30VX.3, 35J, 35N.3
	62343	300cm x 52,5cm x 90W cm	35FX, 35JX, 35NX, 35UJ, 40Z
	62299	300cm x 109cm x 39W cm	22UX, 28UX
	84613	320cm x 86cm x 52T cm	CL35
	62409	400cm x 72,5cm x 70W cm	40J
	62412	400cm x 72,5cm x 72N cm	45NX.2
	62413	400cm x 72,5cm x 72W cm	40NX, 45J.2, 45N, 45UJ
62417	400cm x 72,5cm x 74KW cm	50VX, 50Z, 55J, 55N, 55UJ	
62419	400cm x 72,5cm x 74W cm	50VX, 50Z, 55J, 55N, 55UJ	
62422	400cm x 72,5cm x 82W cm	65VX	
62435	450cm x 71cm x 82cm	65UJ, 70Z, 75NX, 75UJ, 80NX, 80VX	
62440	450cm x 73,5cm x 86cm	75UJ	
ISEKI	84512	180cm x 60cm x 33cm	XL260, XL360
	62211	180cm x 72cm x 33cm	XL400
	28351	200cm x 72cm x 39cm	XC450
ITALMEC	62276	250cm x 72cm x 57cm	PLATFORM
IWAFUJI	62211	180cm x 72cm x 33cm	450
	28335	180cm x 72cm x 34cm	CT045
	28329	180cm x 72cm x 37cm	CT7NX, IS 07
	28346	200cm x 72cm x 34cm	CT045
	62228	200cm x 72cm x 41cm	CT100, CT100R, CT200R
	28332	230cm x 72cm x 41cm	CT 150 R
	28327	230cm x 72cm x 42cm	CT 120
	28326	230cm x 72cm x 43cm	CT 10, CT 12, CT10N, CT12N
	62320	300cm x 52,5cm x 74W cm	CT27N
	62336	300cm x 52,5cm x 84W cm	CT35N
	62362	320cm x 100cm x 38cm	CT230
	62363	320cm x 100cm x 40cm	IS27F

Brand	Art./Ref.	Misura/Size	Applicazione/Application
IWAFUJI	62365	320cm x 100cm x 42cm	CT250
	62409	400cm x 72,5cm x 70W cm	CT40N
	62417	400cm x 72,5cm x 74KW cm	CT50N
	62419	400cm x 72,5cm x 74W cm	CT50N
JCB	62212	180cm x 72cm x 35cm	MICRO
	28329	180cm x 72cm x 37cm	MICRO, MTL200, TD10, TD10SL
	28327	230cm x 72cm x 42cm	801, 801 R, 801FDI
	28326	230cm x 72cm x 43cm	801, 801R
	28330	230cm x 96cm x 31cm	801, 801 R, 801,4, 801,5, 801,6, 801,7, 801,8, 801,2, 801,4, 801,5, 801,5.2, 801,6, 801,7, 801,8, 801,8 TG
	28331	230cm x 96cm x 33cm	801,6, 801,8, 801,8X
	84580	250cm x 96cm x 38cm	8020
	84583	250cm x 109cm x 36cm	802, 802 PLUS, 802 SUPER, 802.4
	84585	250cm x 109cm x 38cm	8025ZTS
	84586	250cm x 109cm x 41cm	8027Z, 8030ZTS
	62320	300cm x 52,5cm x 74W cm	802.8
	62336	300cm x 52,5cm x 84W cm	803, 803 MAGNUM,, 803 PLUS, 803 SUPER, 8032Z, 803E, 830
	62290	300cm x 109cm x 36W cm	802.7, 802.7PLUS
	62305	300cm x 109cm x 41W cm	803, 803 PLUS, 8032Z, 8032ZTS, 8035Z, 8035ZTS, 803E, 803MAGNUM, 803SUPER, 830
	84609	320cm x 86cm x 50B cm	ROBOT 180HF
	62381	320cm x 86cm x 52B cm	ROBOT 190 T
	62365	320cm x 100cm x 42cm	803ALT
	62366	320cm x 100cm x 43cm	803.2
	62368	320cm x 100cm x 45cm	803.3
	62386	350cm x 108cm x 41W cm	804, 804PLUS
	62417	400cm x 72,5cm x 74KW cm	805, 805.2, 8052, 8055RTS, 8060
	62418	400cm x 72,5cm x 74N cm	8045ZTS
	62419	400cm x 72,5cm x 74W cm	805, 805.2, 8052, 8055RTS, 8060
62439	450cm x 73,5cm x 80cm	J570	
84632	450cm x 81,5cm x 76cm	8080ZTS, JZ70	
62455	450cm x 86cm x 52cm	ROBOT110, ROBOT190T	
JOHN DEERE	28326	230cm x 72cm x 43cm	15
	62366	320cm x 100cm x 43cm	25, 30
	62413	400cm x 72,5cm x 72W cm	50ZTS
	62445	450cm x 81cm x 74W cm	80
KAIDI	28326	230cm x 72cm x 43cm	103, 103.3, WY 1.5
KATO	62413	400cm x 72,5cm x 72W cm	HD140
	62417	400cm x 72,5cm x 74KW cm	HD140, HD205UR, HD50UR, HD55UR
	62419	400cm x 72,5cm x 74W cm	HD140, HD205UR, HD50UR, HD55UR
	62436	450 X 71 X 84	70, HD307
KAWASAKI	62199	200cm x 72cm x 35cm	MINICARRIER
	84631	450cm x 81,5cm x 74cm	KE60
KOBELCO	28344	180cm x 72cm x 36cm	SK005
	28329	180cm x 72cm x 37cm	SK 002, SK 007, SK 007.1, SK 007.2, SK 007.3, SK 009, Z11 (CRAWLER CRANE)
	62214	180cm x 72cm x 38cm	FC50
	62216	180cm x 72cm x 40cm	SK09SR
	62217	180cm x 72cm x 40cm	SK09SR
	84526	230cm x 48cm x 70K cm	13SR, SK13SR, SK15MSR, SK16MSR, SK17
	62238	230cm x 48cm x 72cm	SK015R, SK15SR, SK15SR.1, SK20MSR
	28326	230cm x 72cm x 43cm	SK 014
	28330	230cm x 96cm x 31cm	115, SK 013, SK 015, SK013.1, SK014, SK014.1, SK015.1, SK15
	28365	230cm x 96cm x 36cm	SK 15 SR, SK15R, SK15SR.1
	62256	250cm x 52,5cm x 72K cm	SK20SR.2
	62258	250cm x 52,5cm x 76K cm	25SR2, SK25SR.2
	62259	250cm x 52,5cm x 76N cm	20SR
	62262	250cm x 52,5cm x 80K cm	25SR, SK27SR.3

Brand	Art./Ref.	Misura/Size	Applicazione/Application
<b>KOBELCO</b>	84579	250cm x 96cm x 36cm	SK015R, SK20MSR
	84580	250cm x 96cm x 38cm	SK020SR, SK20SR
	62278	260cm x 109cm x 35cm	SK020
	62332	300cm x 52,5cm x 82W cm	SK024, SK027, SK027.1, SK030, SK030.1, SK030.2, SK030SR, SK030UR, SK030UR.1, SK030UR.2, SK27, SK30SR, SK30SR.1, SK30SR.2, SK30UR, SK30UR.1, SK30UR.2, Z14
	62338	300cm X 52,5cm X 86W cm	SK035, SK035COUPE
	84595	300cm x 52,5cm x 88K cm	SK35SR, SK35SR.3
	62387	350cm x 108cm x 42W cm	SK035, SK035 COUPE, SK035.1, SK035.2
	84615	350cm x 108cm x 44cm	SK035SR, SK035SR.2, SK35SR.3
	62388	350cm x 109cm x 41W cm	SK032, Z15
	62423	400cm x 74cm x 68N cm	SK40SR, SK40SR.ZT, SK40SR3
	62424	400cm x 74cm x 72N cm	B69, SH045.2, SK042, SK042.1, SK045, SK045.1, SK045KOUPE, SK050.1, SK45, SK45.1, SK45SR, SK45SR.2, SK45SR.ZT, SK45SR3, SK50, SK50.1, SK50UR, SK50UR.1, SK50UR.2
	84631	450cm x 81,5cm x 74cm	SK60, SK60 UR, SK60.1, SK60.2, SK60.3, SK60ZT, SK75UR, SK75UR.1, SK75UR.2
84632	450cm x 81,5cm x 76cm	SK70SR, SK70SR.2, SK75UR.3, SK80, SK80MSR	
84633	450cm x 81,5cm x 78cm	SK95	

<b>KOMATSU</b>	62201		PC02, PC02.1A, PC02.A
	62212		PC09
	28329		PC 03.1, PC 03.2, PC 03.2AVANCE, PC09UTILITY
	62227		PC08, PC08U, PC08UU, PC08UU.1, PC09FR
	62228		PC10MR, PC10MR1, PC10UU, PC10UU.3, PC15MR
	28327		PC 05-1, PC 05-5, PC05, PC05.2, PC05.6
	28326		PC09FR.1
	28358		PC07.7FR.1, PC15FR.1
	84528		PC07.7FR.1, PC15FR.1
	28330		PC 05-6, PC 05-7, PC 07, PC 07-6, PC 07-7, PC 15R, PC.07 AVANCE R, PC05, PC05 AVANCE R, PC05R, PC07.1, PC07.2, PC07.7, PC07R, PC12.8R AVANCE R, PC12R UTILITY, PC12R.8, PC12R.8 MISTRAL HS, PC14, PC14R.2, PC15.R AVANCE, PC15R MISTRAL, PC15R.8, PC15RHS, PC16, PC16MR2, PC16R, PC16R2
	84571		PC14HS, PC14R.2, PC15MR, PC15MR1, PC16HS, PC16R2, PC18, PC18MR2, U15
	84574		PC05, PC05.6, PC05.7, PC05AVANCE R, PC05R, PC07, PC07.1, PC07.2, PC07.6, PC07.7, PC07.7 AVANCE R, PC07R, PC12 RUTILITY, PC12R.8, PC12R.8 AVANCE R, PC12R.8 MISTRAL HS, PC15R, PC15R MISTRAL, PC15R.8, PC15R.8 AVANCE, PC15RHS
	62258		PC10.6, PC10.7, PC10R, PC12, PC12 AVANCE R, PC12.1, PC12.2, PC12.2R, PC12R, PC12R.7UU, PC12UU, PC12UU.1, PC20.8, PC20R, PC20R.8
	62259		PC10R.8, PC12R, PC12R8 ADVANCE, PC12UU, PC12UU.1, PC12UU.2, PC20.8, PC20MR.1, PC20R.8, PC20UU3
	84577		PC20MR, PC20MR.1, PC20MR.2, PC20MRX, PC20MRX UTILITY, PC20UU, PC20UU3 ADVANCE
	62262		PC15R, PC20.7, PC25R.8, PC28.1, PC28UU.3
	84578		PC15.2, PC15.6, PC28UU
	84589		PC10, PC10 AVANCE R, PC10.5, PC10.6, PC10.7, PC10R.8, PC12UU.2
	62324		PC15.7
	62325		PC15.7
	62327		PC28UU.2
	62328		PC15.3, PC15R, PC15V, PC20, PC20 AVANCE R, PC20.6, PC20.7, PC20R, PC25R, PC25R.8, PC27, PC27MR, PC27MR2, PC27MRX, PC27R.8, PC28, PC28 AVANCE R, PC28.1, PC28.2, PC28R, PC28UU, PC28UU.1, PC28UU.2, PC28UU.3
	62334		PC25.2, PC25.7
	62335		PC20, PC20.2, PC20.6, PC25, PC25.1, PC25.2, PC25AVANCER, PC25R, PC30.6, PC30.7, PC30.7E, PC30AVANCER, PC30MR, PC30MRX, PC30R, PC30R.8, PC30UU.3, PC35MR, PC35MR.1, PC35MRX, PC35R.8, PC38.2, PC38.2AVANCER, PC38UU.2, PC38UU.3, PC38UUM.2
	62337		PC30MR2, PC30MR3, PC30MRX, PC35MR.2
	62355		PC15, PC15 AVANCE R, PC20.8, PC20R UTILITY, PC25R.8, PC27R UTILITY, PC28R.8
	62357		PC25.7, PC35R, PC35RUTILITY
	62350		PC30FR.2
	62291		PC20UU3
	62303		PC20, PC20.2, PC20.6, PC25, PC25.1, PC25AVANCE R, PC25R, PC30, PC30 AVANCE R, PC30.6, PC30.7, PC30.7E, PC30R, PC30R.8, PC30UU.3, PC35, PC35R, PC35R.8, PC38, PC38.2, PC38.2 AVANCE R, PC38UU.2, PC38UU.3, PC38UUM.2
	62381		CK20, CK25.1
	84610		CK30.1, CK35.1
	62385		CD23

Brand	Art./Ref.	Misura/Size	Applicazione/Application
KOMATSU	62363		PC10
	62366		PC15.1
	62368		PC20, PC20.5, PC30, PC30.5
	62374		PC30FR
	62408		PC38, PC38.1, PC38UU, PC38UU.1, PC38UU.2, PC40, PC40.1, PC40.5, PC40.6, PC50, PC50.1, PC50UU, PC50UU.1
	62412		PC40.7, PC40AVANCER, PC40MR, PC40MR.1, PC40MRX, PC40R, PC40R.8, PC45, PC45.1, PC45.1E, PC45.7, PC45AVANCER, PC45MR.1, PC45MR.2, PC45MRX, PC45R, PC45R UTILITY, PC45R.8, PC50.2, PC50.2 AVANCE R, PC50.3, PC50FR.1, PC50FR.2, PC50M.2, PC50UU.2, PC50UU.2E, PC50UU.3, PC50UU.2, PC58
	62418		PC40MR.2, PC50FR.2, PC50MR, PC50MR.1, PC50MR.2
	62401		PC38, PC38.1, PC38UU, PC38UU.1, PC38UU.2, PC40, PC40.1, PC40.5, PC40.6, PC50, PC50.1, PC50UU, PC50UU.1
	62402		PC40.7, PC40R, PC45, PC45.1, PC45.7, PC50.2, PC50.2 AVANCE R, PC50UU.2, PC50UU.2E
	62441		PC75, PC75.1, PC75R, PC75R.2, PC75R.8
	84627		PC95
	62450		PC60.6, PC60.7, PC60.8, PC70.7
	62451		PC60.6, PC70FR.1, PC75.1, PC75.2, PC75.6, PC75MR6, PC75UU, PC75UU.1, PC75UU.2, PC75UU.3, PC78MR6, PC78US.5, PC78US.6, PC78UU.6, PC88MR6
	84636		1020 TURBO, CK1122.5, CK30, CK30.1, CK35.1
	84647		PC70.6, PC70.7
62433		PC60.7, PC70FR.1	
84648		PC60, PC60.5, PC60.6, PC60.7, PC70, PC75, PC75.1, PC75.2, PC75.6, PC75U.1, PC75UU, PC75UU.1, PC75UU.2	

KUBOTA	62201	150cm x 72cm x 33cm	K005, KH005
	28342	180cm x 60cm x 34cm	KC40
	28344	180cm x 72cm x 36cm	CK 08, FH007, K007, KH 21, KH007, KX007
	28329	180cm x 72cm x 37cm	K 008, K 008.2, K 008.3, K 008DH, KH 007, KH 008, KH 07, KX 008, KXB 300, U008, U008.3
	62213	180cm x 72cm x 37cm	K008.3, U008.3
	62215	180cm x 72cm x 39cm	KX21
	62216	180cm x 72cm x 40cm	U10, U10.3
	62217	180cm x 72cm x 40cm	U10.3
	28346	200cm x 72cm x 34cm	
	62199	200cm x 72cm x 35cm	RY600
	28351	200cm x 72cm x 39cm	KC50.1, KC50L, KC50LZ, KC51
	62232	230cm x 48cm x 60cm	K013, K015, KH012, KH41, KN36, KX012, KX014, KX041, KX36, KX36.2, KX41, KX41.2, KX41L
	62234	230cm x 48cm x 64cm	KX36.3, KX41.2S, KX41.2SC, KX41.3SGL
	84526	230cm x 48cm x 70K cm	U17.3
	28327	230cm x 72cm x 42cm	HG, KH 012 VECCHIO TIPO, KH 012G, KH 012GH, KH 014, KH 014G, KH 014HG, KH 05, KH 12, KH 28, KH 31, KH 35, KH 36, KH 37, KH 41, KH 5, KH041, KH120, KH14, KH14G, KH14HG, KH38, KH50, KH55, KH55G, KH55GSRX, KH55R, KH55X, KM41
	28326	230cm x 72cm x 43cm	KH41
	28334	230cm x 72cm x 45cm	KC120, KC140
	28357	230cm x 72cm x 46cm	KC120, KC50, KC80D
	28355	230cm x 72cm x 48cm	KC110
	84529	230cm x 72cm x 49cm	KC100
	62248	230cm x 72cm x 50cm	KC100H
	84530	230cm x 72cm x 52cm	KC121
	28360	230cm x 96cm x 32cm	KX36.3, KX41.2SC, KX41.3SGL
	84571	230cm x 96cm x 35cm	KX41.2VC, KX41.3V, U15, U15.3
	62254	250cm x 47cm x 84cm	U20.3, U20.3V
	62259	250cm x 52,5cm x 76N cm	K022, KX61.2
	62266	250cm x 72cm x 45cm	KC120, KC140
	62271	250cm x 72cm x 50cm	KC100H
	62272	250cm x 72cm x 52cm	KC121
	62277	250cm x 96cm x 41K cm	RX202, U20
	62316	300cm x 52,5cm x 72N cm	KH021, KH021HG, KH024, KH026, KH50, KH51, KH52, KH55, KH60, KH66, KH71, KN51, KX021, KX024, KX026, KX51, KX61
	62317	300cm x 52,5cm x 72W cm	KH026G, KH61
	62322	300cm x 52,5cm x 76N cm	K020, K022, K025, KH27, KH60, KH65, KH66, KH71, KX021, KX021UR, KX027, RX0201
62323	300cm x 52,5cm x 76W cm	KH02, KH026HG, KH02G, KH02HG, KH060, KH071, KH24, KH24HG, KH26HG, KX02, KX60	
62328	300cm x 52,5cm x 80N cm	K028, K030, KX021UR, KX71.2	
62335	300cm x 52,5cm x 84N cm	KX035	

Brand	Art./Ref.	Misura/Size	Applicazione/Application
<b>KUBOTA</b>	<b>62336</b>	300cm x 52,5cm x 84W cm	K035, KH033, KH033HG, KH040, KH101, KH90, KX033, KX101, KX90, RX301, RX301UR, RX302, RX303, SK031, U30, U30.1, U30.2, U30HG, U35, U35HG, UX30
	<b>62347</b>	300cm x 53cm x 80K cm	K030.3, KX030.3, KX61.3, KX71.3, KX91.3, U25.3, U25.3G
	<b>62348</b>	300cm x 53cm x 84K cm	K035.3, KX101.3, U30.3, U35.3
	<b>62355</b>	300cm x 55cm x 78N cm	KX91.2S
	<b>62286</b>	300cm x 109cm x 35N cm	KH021, KH021HG, KH024, KH026, KH50, KH51, KH52, KH55, KH60, KH66, KH71, KN51, KX021, KX071
	<b>62287</b>	300cm x 109cm x 35W cm	KH026G, KH61
	<b>62292</b>	300cm x 109cm x 37N cm	K025, KH60, KH65, KH66, KH71
	<b>62293</b>	300cm x 109cm x 37W cm	KH02, KH026HG, KH02G, KH02HG, KH060, KH071, KH24, KH24HG, KH26HG
	<b>62299</b>	300cm x 109cm x 39W cm	KH030, KH030G, KH030HG, KH033, KH033HG, KH91, KX030, KX033, R30P
	<b>62304</b>	300cm x 109cm x 41N cm	KX035
	<b>62305</b>	300cm x 109cm x 41W cm	K035, KH033, KH033HG, KH040, KH101, KH90, KX033, KX101, KX90, RX302, RX303, U30, U30.1, U30.2, U30HG, U35HG, UX30
	<b>62384</b>	320cm x 90cm x 56cm	RG30
	<b>62385</b>	320cm x 90cm x 58cm	KC250HR
	<b>62363</b>	320cm x 100cm x 40cm	KH26SR, KH30SR, KH30SRG
	<b>62366</b>	320cm x 100cm x 43cm	KH26SR, KH30SR, KH30SRG
	<b>62395</b>	350cm x 54,5cm x 86cm	KX121.3
	<b>62396</b>	350cm x 56cm x 84W cm	K038, KX038, KX121.2, KX121.2S
	<b>62409</b>	400cm x 72,5cm x 70W cm	KX130
	<b>62413</b>	400cm x 72,5cm x 72W cm	K040, K045, K151, KH040, KH045, KH130, KH151, KX040, KX045, KX151, KX151.2, KX161.2, KX161.2SR, U45, U45G
	<b>62415</b>	400cm x 72,5cm x 74K cm	KX161.3, U45.3, U50.3
	<b>62417</b>	400cm x 72,5cm x 74KW cm	KX161.3, RX501, RX502, RX502VA, U45.3, U50.3
	<b>62419</b>	400cm x 72,5cm x 74W cm	KX161.3, RX501, RX502, RX502VA, U45.3, U50.3
	<b>62420</b>	400cm x 72,5cm x 76W cm	KH055, KH055N
	<b>84625</b>	400cm x 144cm x 38cm	RX501
	<b>62430</b>	400cm x 100cm x 52cm	KH50SR, KH51SR, KH52SR
	<b>62431</b>	420cm x 100cm x 54cm	K50SR, KH50SR, KH51SR, KH52SR
<b>62443</b>	450cm x 81cm x 72W cm	KH191, KX191, KX60.2, KX60.3	
<b>62445</b>	450cm x 81cm x 74W cm	KX60.5, KX75UR.3	
<b>62447</b>	450cm x 81cm x 76W cm	KX75UR, KX75UR.3	
<b>84632</b>	450cm x 81,5cm x 76cm	KX080.3	
<b>LEO</b>	<b>28326</b>	230cm x 72cm x 43cm	12G, 16GT, 16H, 16T, 22T, 23, 23H, 23T, 25, 25T
	<b>84530</b>	230cm x 72cm x 52cm	26
	<b>62276</b>	250cm x 72cm x 57cm	26T, 30, 301, 36, 36T
<b>LIBRA</b>	<b>28342</b>	180cm x 60cm x 34cm	T035
	<b>28335</b>	180cm x 72cm x 34cm	DUMPY, T 060 (CARRIER), T 090 (CARRIER)
	<b>28344</b>	180cm x 72cm x 36cm	104TL
	<b>62227</b>	200cm x 72cm x 40cm	T071, TP070
	<b>62247</b>	230cm x 72cm 44cm	T100
	<b>28334</b>	230cm x 72cm x 45cm	104TL, 114, 114 S, 115 T, 116 S, 118, 118 S, 118 SV, 118SB, 120, 214S, 216 S, 218 SV, 218S, 219RSV, 220 R
	<b>28331</b>	230cm x 96cm x 33cm	106T2, 106TL
	<b>62266</b>	250cm x 72cm x 45cm	104TL, 114, 114S, 115T, 116S, 118, 118S, 118SB, 118SV, 120
	<b>62319</b>	300cm x 52,5cm x 74N cm	125S, 212T2, 225S
	<b>62328</b>	300cm x 52,5cm x 80N cm	130S, 135S, 230S, 235S
	<b>62355</b>	300cm x 55cm x 78N cm	229S, 234S, CZ30
	<b>62289</b>	300cm x 109cm x 36N cm	125S, 212T2, 225S
	<b>62298</b>	300cm x 109cm x 39N cm	130S, 135S, 230S, 235S
	<b>62413</b>	400cm x 72,5cm x 72W cm	150S, 254S
	<b>62417</b>	400cm x 72,5cm x 74KW cm	CZ55N
<b>62419</b>	400cm x 72,5cm x 74W cm	CZ55	
<b>LIFTON</b>	<b>62250</b>	230cm x 72cm x 56cm	TD15
<b>LINK BELT</b>	<b>62439</b>	450cm x 73,5cm x 80cm	1600, LS1600C
<b>LUMESA</b>	<b>28351</b>	200cm x 72cm x 39cm	LUMESA

Brand	Art./Ref.	Misura/Size	Applicazione/Application
MAEDA	62216	180cm x 72cm x 40cm	MC104C
MANITOU	28326	230cm x 72cm x 43cm	1.16S
MASSEY FERGUSON	28330	230cm x 96cm x 31cm	114, 115
	62332	300cm x 52,5cm x 82W cm	131
	62296	300cm x 109cm x 38W cm	125, 128
	62302	300cm x 109cm x 40W cm	131, MF130
	62387	350cm x 108cm x 42W cm	MF135
	62412	400cm x 72,5cm x 72N cm	MF145, MF150
MAWECO	28346	200cm x 72cm x 34cm	703
	28326	230cm x 72cm x 43cm	TB10, TC10
	62247	230cm x 72cm 44cm	1003, 640.3
	28355	230cm x 72cm x 48cm	1302
	62248	230cm x 72cm x 50cm	YFW BR
	62268	250cm x 72cm x 47cm	1003
	62271	250cm x 72cm x 50cm	YFWBR
MAXIMA	28335	180cm x 72cm x 34cm	G510L, IC20
	28346	200cm x 72cm x 34cm	G510L, IC20
	62236	230cm x 48cm x 68cm	TB16
	28326	230cm x 72cm x 43cm	TB15
	62369	320cm x 100cm x 46cm	TB36
MECALAC	62436	450 X 71 X 84	8MCR
MENZIMUCK	28340	200cm x 72cm x 42cm	C 14, C 19
MERLO	28335	180cm x 72cm x 34cm	CINGO M6
	62212	180cm x 72cm x 35cm	CINGO M6, CINGO M8
	62246	230cm x 72cm x 40cm	CINGO M10
MESSERSI	62202	150cm x 72cm x 34cm	TCH09
	28335	180cm x 72cm x 34cm	CH1, CH2, CH3, CM1
	28329	180cm x 72cm x 37cm	CH 2/R, M08
	62234	230cm x 48cm x 64cm	M18BE/C
	28334	230cm x 72cm x 45cm	M08E, M15, M16, M18, M20
	84530	230cm x 72cm x 52cm	TCH12, TCH15, TCH1500, TCH155
	28360	230cm x 96cm x 32cm	M18BE/C
	28331	230cm x 96cm x 33cm	M18BE, MS16BV
	62266	250cm x 72cm x 45cm	M08E, M15, M16, M18, M20
	62272	250cm x 72cm x 52cm	TCH12, TCH15, TCH155
	84581	250cm x 96cm x 40cm	M22U
	62325	300cm x 52,5cm x 78N cm	35PG
	62331	300cm x 52,5cm x 82N cm	M32
	62352	300cm x 55cm x 72N cm	M25, M28
	62353	300cm x 55cm x 74N cm	M25
	62355	300cm x 55cm x 78N cm	M30, M35
62413	400cm x 72,5cm x 72W cm	M50	
MINICARRIER	28326	230cm x 72cm x 43cm	TL 10, YB10
	28334	230cm x 72cm x 45cm	YEW5D1, YFW5
	62266	250cm x 72cm x 45cm	YEW5D1, YFW5
	62271	250cm x 72cm x 50cm	YEW8D, YFWBR
	62398	350cm x 90cm x 44cm	TL20
MINICRUSHER	62242	230cm x 48cm x 80cm	MINICRUSHER
MINIDIG	28335	180cm x 72cm x 34cm	G500
	62226	200cm x 72cm x 37cm	GR700A, GR900

Brand	Art./Ref.	Misura/Size	Applicazione/Application
MINITRACK	28346	200cm x 72cm x 34cm	709
	28327	230cm x 72cm x 42cm	808
	62247	230cm x 72cm x 44cm	1003
	84530	230cm x 72cm x 52cm	1003
	84590	280cm x 72cm x 48cm	1302
MITSUBISHI	62201	150cm x 72cm x 33cm	ME05
	28342	180cm x 60cm x 34cm	
	28344	180cm x 72cm x 36cm	ME 08, ME 08B, MM 08B
	28334	230cm x 72cm x 45cm	MS010
	28330	230cm x 96cm x 31cm	MM15.7, MM15T
	28331	230cm x 96cm x 33cm	ME 15, MH15, MM15
	62251	230cm x 96cm x 37cm	MX15
	62266	250cm x 72cm x 45cm	MS010
	62317	300cm x 52,5cm x 72W cm	MM25
	62320	300cm x 52,5cm x 74W cm	20SR, ME20, ME25, MM20, MM20CR, MM20SR, MM20T
	62323	300cm x 52,5cm x 76W cm	MM25, MM25T
	62336	300cm x 52,5cm x 84W cm	MM35, MM35B, MM35T, MM40SR
	62287	300cm x 109cm x 35W cm	MM25
	62290	300cm x 109cm x 36W cm	ME20, ME25
	62299	300cm x 109cm x 39W cm	ME30, ME35, MX35
	62362	320cm x 100cm x 38cm	MS020
	62363	320cm x 100cm x 40cm	MS020, MXR30
	62366	320cm x 100cm x 43cm	MS020, MS030, MS035, MS30SR, MXR30, MXR35, MXR35SR
	62409	400cm x 72,5cm x 70W cm	ME40, ME45, MX45
62413	400cm x 72,5cm x 72W cm	MM40B, MM40CR, MM40T, MM45, MM45B, MM45T, MM55, MM55SR, MM57SR, MX45	
62430	400cm x 100cm x 52cm	MS040	
62431	420cm x 100cm x 54cm	MX55, MXR50, MXR55	
MOROOKA	84645	450cm x 100cm x 65cm	MST500, MST600V
	84652	500cm x 90cm x 78cm	MST600, MST600V, MST600VD
MULTIDRILL	28335	180cm x 72cm x 34cm	SL
	62234	230cm x 48cm x 64cm	PL
	84530	230cm x 72cm x 52cm	ML
	28360	230cm x 96cm x 32cm	PL
	62272	250cm x 72cm x 52cm	ML
NAGANO	28335	180cm x 72cm x 34cm	ES-80, ES-90
	28344	180cm x 72cm x 36cm	NS08.2
	62214	180cm x 72cm x 38cm	MX08XT
	28346	200cm x 72cm x 34cm	ES90
	62232	230cm x 48cm x 60cm	T15S, T15V
	28326	230cm x 72cm x 43cm	ES180.2, MX14.1
	28331	230cm x 96cm x 33cm	ES-150, HIGHLAND NS 15-2, MX-15, MX-16XT, NAGANO ES-180, NS 15, TS 15, TS15S, TS17SE
	62251	230cm x 96cm x 37cm	NS20, TS20
	62319	300cm x 52,5cm x 74N cm	YS27S
	62323	300cm x 52,5cm x 76W cm	T25S
	62328	300cm x 52,5cm x 80N cm	TS30R
	62337	300cm x 52,5cm x 86N cm	NS35.2A, NS35.2B
	62352	300cm x 55cm x 72N cm	ES300, NS25, TS25
	62355	300cm x 55cm x 78N cm	NB30, NS30, NS35, TS35
	62357	300cm x 55cm x 82N cm	ES400, NS35.2, T35S
	84601	320cm x 54cm x 74cm	TS25
	62377	320cm x 54cm x 78N cm	TS30
	84604	320cm x 54cm x 82cm	MX35
	62409	400cm x 72,5cm x 70W cm	NS45, TS45, TS45S
	62413	400cm x 72,5cm x 72W cm	ES500, MX50, NS45.2, T45S, TS45
62437	450cm x 71cm x 86cm	MX80	



Brand	Art./Ref.	Misura/Size	Applicazione/Application
NANTE	62234	230cm x 48cm x 64cm	NT16
	62438	450cm x 71cm x 88cm	NT80
NEUSON	28329	180cm x 72cm x 37cm	803
	84526	230cm x 48cm x 70K cm	EH16
	62246	230cm x 72cm x 40cm	1600
	28326	230cm x 72cm x 43cm	1200, 1200 RD, 1202, 1302, 1302 RD, 1302 RD SLR, 1400 RD, 1402, 1402 RD, 1402 RD PRIMUS, 1402 RD SLR, 1500, 1500 RD, 1500 RD SLR, 1501, 1502, 1502 RD, 1502 RD SLR, 1600, 1902 RD SLR, 2000, 2000 RD, 2100, 2100 RD, 2300, 2300 RD, 2500, 2500 RD, 2700, 2700 RD
	28331	230cm x 96cm x 33cm	1402 RD FORCE, 1402 RD SLR PRIMUS, 1402RD, 1402RD SLR, 1403, 1403RD, 1404, 1502 RD FORCE, 1702, 2201, ME 1402 US MARKET
	28365	230cm x 96cm x 36cm	1503, 1503RD, 1703, 1902 RD FORCE, 1902FORCE, 1902RD, 2202 RD FORCE, 2202RD
	62275	250cm x 72cm x 56cm	TD15, TD18
	84580	250cm x 96cm x 38cm	1903, 1903RD, 2203, 2203RD
	62319	300cm x 52,5cm x 74N cm	2600, 2600RD, 2702, 2702RD, 2702RDSRL, 2800, 2902, 2902RDFORCE
	62323	300cm x 52,5cm x 76W cm	2503, 2503RD
	62328	300cm x 52,5cm x 80N cm	3000, 3200RD, 3402, 3602, 3602RD, 3602RDFORCE, 3602RDSRL
	62332	300cm x 52,5cm x 82W cm	28Z3
	62336	300cm x 52,5cm x 84W cm	3503, 3503RD, 3503RD VARIO, 3703, 3703RD
	62352	300cm x 55cm x 72N cm	2702RD FORCE, 2702RD SCR, 2800RD, 2902RD
	62289	300cm x 109cm x 36N cm	2600RD
	62293	300cm x 109cm x 37W cm	2503, 2503RD
	62296	300cm x 109cm x 38W cm	3003, 3003RD
	62305	300cm x 109cm x 41W cm	3503, 3503RD, 3503RD VARIO, 3703, 3703RD
	62366	320cm x 100cm x 43cm	2600ALT, 2600RD, 2800ALT, 2800RD, 3000RD, 3200RD
	62417	400cm x 72,5cm x 74KW cm	5000RD, 5001, 5001RD, 5001RDSRL, 5002, 5002 POWER, 5002RD, 50Z3RD, 6002, 6002RD, 6003RD
62419	400cm x 72,5cm x 74W cm	5000RD, 5001, 5001RDSRL, 5002, 5002POWER, 5002RD, 501RD, 50Z3RD, 6002, 6002RD, 6003RD	
62436	CINGOLO GOMMA 450 X 71 X 84	7002RD, 8002, 8002RD	
62437	450cm x 71cm x 86cm	70Z3RD, 75Z3	
62441	450cm x 76cm x 80cm	8003RD	
NIBBI	62207	180cm x 60cm x 38cm	NTR350
	28335	180cm x 72cm x 34cm	NTR500, NTR500D
NIKO	28343	180cm x 60cm x 37cm	HP400, HP500, HP510, HP515, HP516
	62207	180cm x 60cm x 38cm	HY13/11
	84523	200cm x 72cm x 38cm	HY610, HY710
	28334	230cm x 72cm x 45cm	HY38/16A, HY38/FS
	28326	230cm x 72cm x 43cm	HY27/16, HY38/16
	84530	230cm x 72cm x 52cm	HY48/2000, HY60
NISSAN	62201	150cm x 72cm x 33cm	H05
	28344	180cm x 72cm x 36cm	H 08-2, H08, N 80-2, N 80-2R, N080, N80, S&B08
	28329	180cm x 72cm x 37cm	H08.1, H08A, H80, H80.2, N080.3LR
	62214	180cm x 72cm x 38cm	H08B, N050, N080, N080.2LR
	62239	230cm x 48cm x 74cm	H22B
	28326	230cm x 72cm x 43cm	N120, N120R, N150, N150R
	28334	230cm x 72cm x 45cm	N06, N060, N120R, N6, RK15
	28357	230cm x 72cm x 46cm	100B3, RT100, RT1000, RT1000B3, RT100B3, RT100D3, RT80
	28330	230cm x 96cm x 31cm	H12A, H15, H15A, H15B, H15PLUS
	28331	230cm x 96cm x 33cm	150N, H12B PLUS.2, H15, H15.1, H15A, H15B.2, N120.2, N150.2, N150.2R
	62251	230cm x 96cm x 37cm	NS20, S&B150, S&B150.2
	62266	250cm x 72cm x 45cm	N06, N060, N120, N120R, N6, RK15
	62319	300cm x 52,5cm x 74N cm	H22A, H24A, H26B, H27, N220.2, N230.2, N230.2R, N250.2, N260.2, N300.2, NS25
	62328	300cm x 52,5cm x 80N cm	H29A, H30.2, H36A, N300.2, N300.2R, N350.2, S&B300, S&B300.2
	62352	300cm x 55cm x 72N cm	H22, H24, H24A, H26B, H27.2
	62355	300cm x 55cm x 78N cm	H29A, H30, H30.2, H30A, H35A
	62357	300cm x 55cm x 82N cm	H36B
	62289	300cm x 109cm x 36N cm	230.2, 230.2R, 250.2, 260.2, 300.2, H22, H24, H27, H27.2, N220.2, NS25
	62298	300cm x 109cm x 39N cm	H30, H35, H36A, N300.2, N300.2R, N350.2, N350.2R, S&B300, S&B300.2
	62299	300cm x 109cm x 39W cm	N35, S&BX.1

Brand	Art./Ref.	Misura/Size	Applicazione/Application
NISSAN	62362	320cm x 100cm x 38cm	N219, N220, N220R, N220RC18, N250, N250R, N250RC18
	62363	320cm x 100cm x 40cm	N15, N20, N220, N220R, N250, N250R, N300, N300R, N350R, S&B1, S&B12, S&B12R, S&B15R, S&B15RC, S&B15S, S&B15SR, S&B20, S&B20S, S&B20SR, S&BX.1, X1
	62366	320cm x 100cm x 43cm	N15, N20, N220R, N250, N250R, N300, N300R, N320, N350, N350.2, N350R, N350R2, N350RH, S&B1, S&B115, S&B15, S&B15R, S&B15RC, S&B15S, S&B15SR, S&B20, S&B20.5, S&B20R, S&B20S, S&B20SR, S&B220
	62409	400cm x 72,5cm x 70W cm	H45, N400.2, N450.2, N450.2R, S&B480
	62413	400cm x 72,5cm x 72W cm	H50B
	62417	400cm x 72,5cm x 74KW cm	S&B25.1, S&B25.2
	62419	400cm x 72,5cm x 74W cm	S&B25.1, S&B25.2
	62430	400cm x 100cm x 52cm	N450, N450R, N550.2
	62431	420cm x 100cm x 54cm	N550.2, S&B225, S&B25, S&B30, S&B30R, S&B30S, S&B330, S&B500, S&B550, S&B580
	62437	450cm x 71cm x 86cm	H75B
62448	450cm x 81cm x 78N cm	S&B45	
84640	450cm x 90cm x 58cm	RT400, RT400E1	
NOZAWA	28346	200cm x 72cm x 34cm	DP 41
	28351	200cm x 72cm x 39cm	CP 3 LLD 2
	62245	230cm x 72cm x 39cm	CP3LLD2
	28357	230cm x 72cm x 46cm	CP6DD
OELLE	28335	180cm x 72cm x 34cm	500.6
OIL & STEEL	28335	180cm x 72cm x 34cm	1055, 1265
	62216	180cm x 72cm x 40cm	1765
	62276	250cm x 72cm x 57cm	1690, 1695
	62366	320cm x 100cm x 43cm	2714
ORESTEIN & KOPPEL	28326	230cm x 72cm x 43cm	RH1 1
	28334	230cm x 72cm x 45cm	CITY, CITY 2.1, RH 1.1, RH 1.15, RH 1.2, RH 2, RH 2.1, RH1, RN 1.1, RN 2.1
	84530	230cm x 72cm x 52cm	RH1.20
	28331	230cm x 96cm x 33cm	RH1.17, RH1.21
	62258	250cm x 52,5cm x 76K cm	RH1.25
	62259	250cm x 52,5cm x 76N cm	RH1.20SR2
	62266	250cm x 72cm x 45cm	CITY, CITY 2.1, RH1, RH1.1, RH1.15, RH1.2, RH2, RH2.1, RN1.1, RN2.1
	62272	250cm x 72cm x 52cm	RH1.20
	62331	300cm x 52,5cm x 82N cm	RH1.30SR2
	84595	300cm x 52,5cm x 88K cm	RH1.35SR2
	62352	300cm x 55cm x 72N cm	RH1.29, RH1.35, RH2.29
	62355	300cm x 55cm x 78N cm	RH1.35
	62363	320cm x 100cm x 40cm	RH1.3, RH1.30
	62366	320cm x 100cm x 43cm	RH1.30, RH1.45
	62370	320cm x 100cm x 48cm	RH1.4, RH2.2, RH2.4
	62413	400cm x 72,5cm x 72W cm	RH1.48
62423	400cm x 74cm x 68N cm	RH1.40SR2	
62424	400cm x 74cm x 72N cm	RH1.45SR2	
ORMAC	28335	180cm x 72cm x 34cm	H2
ORTECO	62366	320cm x 100cm x 43cm	270/11, 270LL
PALAZZAGLI	28335	180cm x 72cm x 34cm	FZ50
	28351	200cm x 72cm x 39cm	FZ80
	28334	230cm x 72cm x 45cm	FZ120
PALAZZANI	28364	230cm x 96cm x 40cm	TSJ24.2
	62272	250cm x 72cm x 52cm	TZ170
	84581	250cm x 96cm x 40cm	TSJ23, TSJ24
	62366	320cm x 100cm x 43cm	RAGNOT 1.20, TSJ18
	62373	320cm x 100cm x 52cm	XTJ30.C
PAUS	62234	230cm x 48cm x 64cm	MB1.6
PAUS - PAUSELLI	62272	250cm x 72cm x 52cm	MB2.0, DC1

Brand	Art./Ref.	Misura/Size	Applicazione/Application
PAUS	62357	300cm x 55cm x 82N cm	MB3.2
PAUSELLI	62272	250cm x 72cm x 52cm	DC1
PAZZAGLIA	28335	180cm x 72cm x 34cm	FZ50
	62245	230cm x 72cm x 39cm	FZ100, FZ110
	28334	230cm x 72cm x 45cm	FZ150
	62266	250cm x 72cm x 45cm	FZ120, FZ150, FZ160
PELJOB ECOMAT	62238	230cm x 48cm x 72cm	EB200, EB200XT, EB200XTV, EB263, EC20, EC20B, EC20BXTV
	28326	230cm x 72cm x 43cm	650S, EB 10, EB 10.4, EB 11, EB 12, EB 12.4, EB 14, EB 14.2, EB 14.4, EB 150 XR, EB271, EC 14, EC15BXR, SIRIUS, SIRIUS 271, SIRIUS PLUS
	28358	230cm x 72cm x 47cm	EB11, EB16, EB16.4, EB16.5
	28331	230cm x 96cm x 33cm	EB 150 XT, EB 150 XTV, EB150, EC 15, EC 15 BI_SPEED, EC 15 BI_SPEED/ADJU.WIDTH, EC 15 XR, EC13, EC15B
	62268	250cm x 72cm x 47cm	16.5, EB11, EB16, EB16.4
	84579	250cm x 96cm x 36cm	EB200, EB200XT, EB200XTV, EB263, EC20, EC20B, EC20BXTV
	62317	300cm x 52,5cm x 72W cm	EB224.4, EB25.4, EB28.4, EB30.4
	62336	300cm x 52,5cm x 84W cm	EB250, EB252, EB28, EB306, EB350, EB350XT, EB36, EB400, EB406, EC35, LS286, LS386, LS406
	62287	300cm x 109cm x 35W cm	EB22.4, EB25.4, EB28.4, EB30.4
	62296	300cm x 109cm x 38W cm	EB250, EB250XT, EB300, EC25, EC30
	62305	300cm x 109cm x 41W cm	EB250, EB252, EB28, EB306, EB350, EB350XT, EB36, EB400, EB406, EC35, LS286, LS406
	62362	320cm x 100cm x 38cm	EB22, EB22.4, EB27
	62366	320cm x 100cm x 43cm	EB36
	62406	400cm x 72,5cm x 68W cm	EB450, EC45
	62409	400cm x 72,5cm x 70W cm	EB506, EC50, LS502
	62413	400cm x 72,5cm x 72W cm	EB506
	62417	400cm x 72,5cm x 74KW cm	EC55, EC55B
	62419	400cm x 72,5cm x 74W cm	EC55, EC55B
62434	450cm x 71cm x 80cm	EB706, EC70	
PENTAMOTER	28327	230cm x 72cm x 42cm	JOLLY
	28334	230cm x 72cm x 45cm	JOLLY 26PK, MAXI DUMPER
PICCINI	28335	180cm x 72cm x 34cm	MINICAR 300
	28340	200cm x 72cm x 42cm	MINICAT 13
	62245	230cm x 72cm x 39cm	MINI 22
	28327	230cm x 72cm x 42cm	MINICAR 500, MINICAT 13
	28326	230cm x 72cm x 43cm	DUMPER, MINICAT 20, MINICAT 22
	62362	320cm x 100cm x 38cm	MINI30, MINICAT30, MINICAT32
PORELLO	28335	180cm x 72cm x 34cm	CAR70, SKY LIFTER
	28327	230cm x 72cm x 42cm	CAR100
POWERFAB	62199	200cm x 72cm x 35cm	1200X
	62227	200cm x 72cm x 40cm	100X, 1200SX, 1250, 1700SX, 7006, HIGH TYPE, HSS11
	28327	230cm x 72cm x 42cm	SAMURAI
POWERPAC	62207	180cm x 60cm x 38cm	RC350, RC500
RAMPICAR	28342	180cm x 60cm x 34cm	R600
	28343	180cm x 60cm x 37cm	R400
	62209	180cm x 72cm x 30cm	FRESIA/RAMPICAR
	28335	180cm x 72cm x 34cm	R 600
RAPID	28342	180cm x 60cm x 34cm	M30, P30
	28343	180cm x 60cm x 37cm	DS601, M450, P45
	62210	180cm x 72cm x 31cm	405
ROCK	28342	180cm x 60cm x 34cm	P30
	28343	180cm x 60cm x 37cm	BFP602, DSP601, M450, P45
	28326	230cm x 72cm x 43cm	20
ROSSI	28326	230cm x 72cm x 43cm	20, R103.3, R105.3

Brand	Art./Ref.	Misura/Size	Applicazione/Application
<b>ROTAIR</b>	28343	180cm x 60cm x 37cm	R500
	62207	180cm x 60cm x 38cm	R35, R50
	28335	180cm x 72cm x 34cm	R600, R70, R800
	62215	180cm x 72cm x 39cm	R
	62228	200cm x 72cm x 41cm	R900
	28358	230cm x 72cm x 47cm	R625
<b>RUFENERKIPPER</b>	28335	180cm x 72cm x 34cm	RK500
	28327	230cm x 72cm x 42cm	RK900 - 2
	28334	230cm x 72cm x 45cm	RK1100, RK1200
	28355	230cm x 72cm x 48cm	RK1100-R, RK1500
	84591	280cm x 72cm x 52cm	RK 1800.2
<b>SACET</b>	62276	250cm x 72cm x 57cm	KC28ALV
<b>SANDQUEEN</b>	28327	230cm x 72cm x 42cm	DUMPER
<b>SATO</b>	28342	180cm x 60cm x 34cm	SC 156 DD, SC 156 DS
	84513	180cm x 60cm x 36cm	SC161DC, SC161DS
	62212	180cm x 72cm x 35cm	SC433DH
	62199	200cm x 72cm x 35cm	SC433LDA, SC433LDS
<b>SCATTRACK</b>	28334	230cm x 72cm x 45cm	116, 516, 520, 520V
	62328	300cm x 52,5cm x 80N cm	533, 535
	62352	300cm x 55cm x 72N cm	530
	62355	300cm x 55cm x 78N cm	130, 135
	62290	300cm x 109cm x 36W cm	125
	62298	300cm x 109cm x 39N cm	533, 535
	62413	400cm x 72,5cm x 72W cm	150
<b>SCHAEFF</b>	28344	180cm x 72cm x 36cm	HR1
	28326	230cm x 72cm x 43cm	HR02
	28334	230cm x 72cm x 45cm	HR2, N120
	28331	230cm x 96cm x 33cm	H15, HR 02, HR 12, HR 2, HR11, HR13
	62266	250cm x 72cm x 45cm	HR02, HR2, N120
	62319	300cm x 52,5cm x 74N cm	H24, H26B, H27, HR24, HR27, HR4A, N250.2, N260.2
	62328	300cm x 52,5cm x 80N cm	HR8, HR8A
	62337	300cm x 52,5cm x 86N cm	HR3.7
	62352	300cm x 55cm x 72N cm	HR14
	62355	300cm x 55cm x 78N cm	HR16, HR35
	62289	300cm x 109cm x 36N cm	H24, H27, HR24, HR27
	62363	320cm x 100cm x 40cm	H3, HR3, HR4, N220
	62366	320cm x 100cm x 43cm	H10, H100, H5, HR10, HR5, HR8, N300, N350
	62413	400cm x 72,5cm x 72W cm	HR18
	62420	400cm x 72,5cm x 76W cm	HR20, HR21, HR22
62437	450cm x 71cm x 86cm	HR32, HR32CI	
62447	450cm x 81cm x 76W cm	HR31	
<b>SEDIDRILL</b>	28326	230cm x 72cm x 43cm	210, 250
	84530	230cm x 72cm x 52cm	210
<b>SHIN-TOWA</b>	28344	180cm x 72cm x 36cm	CL100
	62215	180cm x 72cm x 39cm	NC 180
	84522	200cm x 72cm x 36cm	CL100
	62227	200cm x 72cm x 40cm	CC154, CC235
	28326	230cm x 72cm x 43cm	CC104, CC204, CC205, CC265, CC266, CC285, TC204
<b>SILLA</b>	28326	230cm x 72cm x 43cm	14
	28334	230cm x 72cm x 45cm	ME1400H
	28355	230cm x 72cm x 48cm	18
<b>SUMITOMO</b>	62211	180cm x 72cm x 33cm	LS200FXJ, S10FX, S200FXJ, SH4GX3, SH4J

Brand	Art./Ref.	Misura/Size	Applicazione/Application
SUMITOMO	28329	180cm x 72cm x 37cm	LS300FXJ, S 30 FX, SH 7GX3, SH7J
	62228	200cm x 72cm x 41cm	S30UX.1, SH9UX
	62234	230cm x 48cm x 64cm	SH15J
	62242	230cm x 48cm x 80cm	SH18UJ, SH18UJ2, SH20JX
	28332	230cm x 72cm x 41cm	SH 9UX
	28326	230cm x 72cm x 43cm	LS500FXJ, LS600FXJ, LS600FXJ3, LS600PXJ3, S 50 F2, S 60 F2, S50F2K, S50K
	28358	230cm x 72cm x 47cm	SH10UJ3, SH12JX, SH9UX2, SH9UX3
	28360	230cm x 96cm x 32cm	SH 15J
	84571	230cm x 96cm x 35cm	SH18J
	84581	250cm x 96cm x 40cm	SH18UJ, SH18UJ2, SH20JX
	62317	300cm x 52,5cm x 72W cm	LS700FXJ2, LS700FXJ3, LS800FXJ3, S70FX2, SH25J
	62320	300cm x 52,5cm x 74W cm	S80F2, S80FXZ
	62323	300cm x 52,5cm x 76W cm	LS8000FXJ2, LS800FXJ3, S80F2, S80FX2, S80FXJ3, SH25JX, SH28J
	62336	300cm x 52,5cm x 84W cm	LS1000FXJ2, LS1000FXJ3, S100, S100F2, S100FJ3, SH30JX, SH30JX2, SH32J, SH35J
	62343	300cm x 52,5cm x 90W cm	SH35JX, SH35JX2, SH35UJ, SH38UJ, SH38UJ2, SH40UJ2
	62290	300cm x 109cm x 36W cm	S80F2, S80FXZ
	62299	300cm x 109cm x 39W cm	S90, S90F2, S90FX3, S90FXJ3
	62305	300cm x 109cm x 41W cm	S100, S100F2, S100FJ3
	62409	400cm x 72,5cm x 70W cm	LS1200FXJ2, LS1200FXJ3, S120, S120F2
	62413	400cm x 72,5cm x 72W cm	S5U2, SH40JX, SH40JX2, SH45J, SH55U, SH55U2
	62417	400cm x 72,5cm x 74KW cm	LS1300FXJ2, LS1300FXJ3, LS1350UXJ, S130, S130F2, SH135, SH55J, SH55UJ
	62419	400cm x 72,5cm x 74W cm	LS1300FXJ2, LS1300FXJ3, LS1350UXJ, S130, S130F2, SH135, SH55J, SH55UJ
	84617	400cm x 72,5cm x 78W cm	SH65U.2
	62435	450cm x 71cm x 82cm	SH60, SH65U.1, SH65UJ
62438	450cm x 71cm x 88cm	LS160LC	
62439	450cm x 73,5cm x 80cm	JS70, LS160, S160B2, S160FJ2, SH60, SH60.2	
62440	450cm x 73,5cm x 86cm	S106F2U, S160E, S160F2U, SH75, SH75U, SH75U.2, SH75URG, SH75X.2, SH75XU.2	
SUNWARD	62236	230cm x 48cm x 68cm	SWE15, SWE17
	62355	300cm x 55cm x 78N cm	SWE28
	62358	300cm x 55cm x 84N cm	SWE38
	62412	400cm x 72,5cm x 72N cm	SWE50, SWE55
	62422	400cm x 72,5cm x 82W cm	SWE70
TADANO	62215	180cm x 72cm x 39cm	AC40, AC45SG, AC65SG
TAKEUCHI	28335	180cm x 72cm x 34cm	HUPPI 403, TAK700
	28329	180cm x 72cm x 37cm	TB007, TB07, TB108
	62215	180cm x 72cm x 39cm	TB08
	62199	200cm x 72cm x 35cm	TC425LD
	28351	200cm x 72cm x 39cm	TB008, TB08, TB850B
	62227	200cm x 72cm x 40cm	TC850, TC850S, TCF850
	28340	200cm x 72cm x 42cm	TC 850 S
	62236	230cm x 48cm x 68cm	TB016S/LSA
	28326	230cm x 72cm x 43cm	TB 10S, TB 120R, TB 14, TB 15, TB 650 S, TB105, TB106, TB12, TB120, TB16, TB650, TL10, TZ10
	62247	230cm x 72cm 44cm	HUPPI 640
	28334	230cm x 72cm x 45cm	TC960D3
	28357	230cm x 72cm x 46cm	TC960D3S, TC980
	28330	230cm x 96cm x 31cm	TB 015, TB 980, TL10
	28350	230cm x 96cm x 34cm	TB 016
	84571	230cm x 96cm x 35cm	TB15F, TB15FR
	84574	230cm x 101cm x 30cm	TB15
	62254	250cm x 47cm x 84cm	TB23
	62317	300cm x 52,5cm x 72W cm	TB020
	62332	300cm x 52,5cm x 82W cm	TB030, TB25, TB28FR, TB30UR
	62302	300cm x 109cm x 40W cm	TB30UR
	84611	320cm x 86cm x 46T cm	TL120, TL220
	84612	320cm x 86cm x 48T cm	TL126, TL26
	84613	320cm x 86cm x 52T cm	TL130, TL230
62361	320cm x 100cm x 37cm	TB800, TB800R	

Brand	Art./Ref.	Misura/Size	Applicazione/Application
TAKEUCHI	62362	320cm x 100cm x 38cm	TB20, TB20QR, TB21, TB22
	62363	320cm x 100cm x 40cm	TB25, TB250, TZ330
	62366	320cm x 100cm x 43cm	TB1200, TB250, TB250R, TB300, TB300R, TB350R, TB350R, TZ25, TZ250, TZ250R, TZ26
	62369	320cm x 100cm x 46cm	TB300, TB35, TB350, TB350R, TB355, TB36, TB365, TZ230
	62391	350cm x 52,5cm x 86W cm	TB035, TB135, TB138, TB235
	62413	400cm x 72,5cm x 72W cm	TB55R, TB55UR
	62418	400cm x 72,5cm x 74N cm	TB045, TB145, TB153FR, TB250(NEW), TB53FR
	62447	450cm x 81cm x 76W cm	TB070, TB175, TB180FR, TB80, TB80FR
	84644	450cm x 100cm x 48cm	TL140, TL240
62432	450cm x 100cm x 50cm	TL150, TL250	
TANAKA	28329	180cm x 72cm x 37cm	DC400
	62216	180cm x 72cm x 40cm	DC250
	62226	200cm x 72cm x 37cm	DC152, DC153
	28357	230cm x 72cm x 46cm	DC202, DC224, DC31
TAYLOR CONST. PLANT	28343	180cm x 60cm x 37cm	TCP 500 (CARRIER UK-MKT)
	62210	180cm x 72cm x 31cm	TCP500
TECNIWELL	28344	180cm x 72cm x 36cm	TWH5
TEKNA	28335	180cm x 72cm x 34cm	TC9
	28329	180cm x 72cm x 37cm	T13
	28326	230cm x 72cm x 43cm	K 14/M, K 14/S, K14, K15
	28331	230cm x 96cm x 33cm	K15
TEREX	28331	230cm x 96cm x 33cm	TC15, TC16
	62337	300cm x 52,5cm x 86N cm	AM37R, TC37
	62352	300cm x 55cm x 72N cm	TC29
	62355	300cm x 55cm x 78N cm	TC35
	62413	400cm x 72,5cm x 72W cm	TC48, TC50
	62420	400cm x 72,5cm x 76W cm	TC60
	62437	450cm x 71cm x 86cm	TC75
TERRAJET	28326	230cm x 72cm x 43cm	2514B, 5515A, CITYJET, TERRAJET
TEUPEN	28326	230cm x 72cm x 43cm	LEO 23H, LEO16GT, LEO16H, LEO16T, LEO22T, LEO23T, LEO25, LEO25T
	84530	230cm x 72cm x 52cm	LEO26
	62276	250cm x 72cm x 57cm	LEO26T, LEO30, LEO30T, LEO36, LEO36T
UNIMOV	62227	200cm x 72cm x 40cm	1250
	62246	230cm x 72cm x 40cm	1250
UTEX	28326	230cm x 72cm x 43cm	1.03
VENIERI	28326	230cm x 72cm x 43cm	VF121, VF141, VF161, VF171
VOLVO	62238	230cm x 48cm x 72cm	EC20(BI-SPEED), EC20B, EC20BXTV
	28326	230cm x 72cm x 43cm	EC14, EC15BXR, EC15R, EC15RB
	28331	230cm x 96cm x 33cm	EC13, EC13XR, EC15, EC15 BI-SPEED, EC15B, EC15T, EC15TB, EC15V, EC15VB, EC15XR, EC15XT, EC15XTV
	84579	250cm x 96cm x 36cm	EC20B, EC20BI, EC20BXTV, EC20T, EC20TB, EC20V, EC20VB, EC20XT, EC20XTV, SPEED
	84585	250cm x 109cm x 38cm	EC27C, ECR28, ECR30
	62336	300cm x 52,5cm x 84W cm	EC35, ECR38
	62296	300cm x 109cm x 38W cm	EC25, EC25X, EC30, EC30X
	62305	300cm x 109cm x 41W cm	EC35, EC35C, ECR38
	62406	400cm x 72,5cm x 68W cm	EC45
	62409	400cm x 72,5cm x 70W cm	EC50
	62413	400cm x 72,5cm x 72W cm	ECR48C
	62417	400cm x 72,5cm x 74KW cm	EC55, EC55B, ECR58 PLUS
	62419	400cm x 72,5cm x 74W cm	EC55, EC55B, ECR58 PLUS
	62434	450cm x 71cm x 80cm	EC70, EC70B
62447	450cm x 81cm x 76W cm	ECR88 PLUS	

Brand	Art./Ref.	Misura/Size	Applicazione/Application
WINBULL YAMAGUCHI	28342	180cm x 60cm x 34cm	WB350FP, WB350SF
	28346	200cm x 72cm x 34cm	WB 510, WB 510B
	28351	200cm x 72cm x 39cm	WB700 (MINIDUMPER), WB700EX (MINIDUMPER)
YAMAGUCHI	62211	180cm x 72cm x 33cm	WB710, WB710B
	28335	180cm x 72cm x 34cm	WB450HD, WB450MD, WB500, WB510, WB510B
	62212	180cm x 72cm x 35cm	WB600
	62215	180cm x 72cm x 39cm	WB700, WB700EX
	28346	200cm x 72cm x 34cm	WB450HD, WB450MD, WB500, WB510
	62199	200cm x 72cm x 35cm	WB600
	28351	200cm x 72cm x 39cm	WB07, WB700, WB700EX
	28334	230cm x 72cm x 45cm	WB1000.3
	28357	230cm x 72cm x 46cm	WB1000.3, WB800Z
	62248	230cm x 72cm x 50cm	WB12H
	62266	250cm x 72cm x 45cm	WB1000.3
62271	250cm x 72cm x 50cm	WB1200, WB12H	
62384	320cm x 90cm x 56cm	WB2500	
YANMAR	62200	150cm x 72cm x 28cm	B03, B03 SCOPY
	62202	150cm x 72cm x 34cm	B05, B05 SCOPY, B05R SCOPY, SV05
CHIKUSUI	28342	180cm x 60cm x 34cm	BFP402
YANMAR	28343	180cm x 60cm x 37cm	CG3 HAST, MCG 100, MCG 111F
	62210	180cm x 72cm x 31cm	MCG 131
	84515	180cm x 72cm x 32cm	B08
	62211	180cm x 72cm x 33cm	XYD710B
	28335	180cm x 72cm x 34cm	MCG 131
	62212	180cm x 72cm x 35cm	B03
	28329	180cm x 72cm x 37cm	B 08 SCOPY, B 08R SCOPY, B 08RV SCOPY, B07, B07.1, B08.3, B08.3RV, CG3D, SV08
	62213	180cm x 72cm x 37cm	SV08
	84517	180cm x 72cm x 43Y cm	VIO10
	84521	200cm x 72cm x 31cm	MCG 130
	28346	200cm x 72cm x 34cm	WB500, YM 10, YM10, YMD60
	62226	200cm x 72cm x 37cm	CG3 CARRIER, DC153
	84523	200cm x 72cm x 38cm	MCG 150
	28351	200cm x 72cm x 39cm	B 10, B 10R, DC153, YB 101, YB 101 UZ, YB 101 VL
	62227	200cm x 72cm x 40cm	B1, B1U
	62228	200cm x 72cm x 41cm	K45C
	62230	200cm x 72cm x 47cm	B12.3, B14, B15.3, B15.3PR, B15.3X, B15.EX
	62234	230cm x 48cm x 64cm	B15
	28332	230cm x 72cm x 41cm	B 158, C 6R, CO 6R
	28326	230cm x 72cm x 43cm	B10, B12, B12.1, B12.2, B12.3, B12.3PR, B14, B14.1, B15, B17, B17.1, B17.2, B17PR, Y 12B, Y12, Y14, YB 10, YB 10.1, YB 10.2, YB 121, YB 151, YBT650
	28357	230cm x 72cm x 46cm	DC224, VIO17, WB1000.1, WB1000.3, WB1000.3S, Y14B
	84527	230cm x 72cm x 46Y cm	VIO17
	28358	230cm x 72cm x 47cm	B17.2, B17.3, B17.3EX, B17EX, B18, B18EX, SV15, SV17, VIO 15, VIO15.2
	84528	230cm x 72cm x 47Y cm	B 17.2, B 17.3, B 17.3EX, B 17EX, B 18EX, B18, SV 15, SV 17, VI 015, VI 015.2
	62248	230cm x 72cm x 50cm	5D.I, 8R, C10R, C10R.1, C10R.3, C8R, CD7CDA, FWS5D1, TFW8R, YEW5D1, YEW8R, YFW8R
	28360	230cm x 96cm x 32cm	B15
	84576	250cm x 48,5cm x 80Y cm	VIO20
	62255	250cm x 48,5cm x 84Y cm	SV20, VIO20 GLOBAL, VIO20.1, VIO20.2, VIO20CR
	62271	250cm x 72cm x 50cm	5D.1, 8R, C10R, C12R, TFW8R
	84587	260cm x 55,5cm x 78Y cm	B24VA, VIO25.3
	62280	260cm x 96cm x 38cm	B19, B19.2, B19PR
	62283	280cm x 106cm x 35Y cm	B22, B22.1, B22.2, B22.2A, B25, B2X, B2X.1, M22, YB221
	62321	300cm x 52,5cm x 76K cm	B2U
62325	300cm x 52,5cm x 78N cm	AURA 28	
62334	300cm x 52,5cm x 84K cm	B4U	
62349	300cm x 55,5cm x 76Y cm	B25V, B25VCR	
84596	300cm x 55,5cm x 78Y cm	VIO25, VIO27.2, VIO27.2GLOBAL	

Brand	Art./Ref.	Misura/Size	Applicazione/Application
<b>YANMAR</b>	<b>62350</b>	300cm x 55,5cm x 82Y cm	B27.2B, B27V, B3.3, B30V, B30VCR, B30VPR, B37.2B, B37V, B37VCR, B37VPR, VI030.1, VI030.2, VI030V, VI035.1, VI035.2, VI035.3, VI035CR
	<b>62383</b>	320cm x 90cm x 52cm	C20R
	<b>62384</b>	320cm x 90cm x 56cm	C25R, C30R, C30R.1, C30RY.1, WB2500, YFW25, YFW25R
	<b>62362</b>	320cm x 100cm x 38cm	Y22, YB191, YB20, YB201, YB221
	<b>62363</b>	320cm x 100cm x 40cm	B31, YB231, YB241, YB241Z, YB251
	<b>62365</b>	320cm x 100cm x 42cm	B27, B3, YB27, YB271, YB271.30
	<b>62366</b>	320cm x 100cm x 43cm	B37, YB21, YB21XR, YB251, YB281, YB281X, YB281X.2, YB281XR, YB28X.2, YB291, YB301, YB301.2U, YB301UZ, YB351, YB352
	<b>62374</b>	320cm x 106cm x 39cm	B27, B27.1, B27.2, B27.2A, B3, B3.2, B32, B32.2, M27, VI030, YB27, YB271, YB32
	<b>62397</b>	350cm x 75,5cm x 74Y cm	VI040.1, VI040.2, VI040V, VI045, VI045CR, VI045SV
	<b>62399</b>	370cm x 107cm x 41K cm	B37, B37.1, B37.2, B37.2A, M37
	<b>62414</b>	400cm x 72,5cm x 72Y cm	B5, B50, B50.2, B50.2A, B6, B6U, BB50.1, VI050CR, VI050PR
	<b>62425</b>	400cm x 75,5cm x 74Y cm	B50.2B, B50V, B50VCR, B50VIO, B6.3, VI045, VI050.1, VI050.2, VI050V, VI055, VI055CR, VI057
	<b>62400</b>	400cm x 107cm x 46K cm	VI040, VI040CR, VI040PR
	<b>84623</b>	400cm x 144cm x 36cm	B5, B5.2, B50, B50.1, B50.2, B50.2A, B50M, B6, B6U, VI0350, VI050, VI050CR, VI050PR
	<b>62403</b>	400cm x 144cm x 36Y cm	B5, B5.2, B50, B50.1, B50.2, B50.2A, B50M, B6, B6U, VI0350, VI050, VI050CR, VI050PR
	<b>62430</b>	400cm x 100cm x 52cm	YB401, YB451, YB501, YB551
	<b>62431</b>	420cm x 100cm x 54cm	BSX, YB551XB
	<b>62434</b>	450cm x 71cm x 80cm	B7
	<b>62451</b>	450cm x 83,5cm x 74K cm	B7, B7 SIGMA, B7U, VI070, VI070.A, VI070CR, VI075, VI075.A, VI075V, VI080
	<b>62452</b>	450cm x 83,5cm x 74Y cm	B7 SIGMA, B7U, VI075, VI075.A, VI075V, VI080
<b>84643</b>	450cm x 90cm x 76cm	C40	
<b>84651</b>	485cm x 92cm x 72cm	SV100, SV100.1	
<b>84653</b>	500cm x 90cm x 82cm	C50R, C50R.1, C50R.2, YFW40, YFW40R, YFW45	
<b>YASHIMA</b>	<b>84513</b>	180cm x 60cm x 36cm	IR 045
<b>ZAVATTINI</b>	<b>84530</b>	230cm x 72cm x 52cm	E19P, E9SC
	<b>62272</b>	250cm x 72cm x 52cm	E19P, E9SC
<b>ZEPPELIN</b>	<b>28334</b>	230cm x 72cm x 45cm	TM1
	<b>28331</b>	230cm x 96cm x 33cm	45, ZR 15, ZR02, ZR15, ZRH02, ZRH12
	<b>62352</b>	300cm x 55cm x 72N cm	ZR14, ZR25, ZRH14
	<b>62355</b>	300cm x 55cm x 78N cm	ZR35, ZRH16
	<b>62289</b>	300cm x 109cm x 36N cm	ZRH04, ZRH4
	<b>62298</b>	300cm x 109cm x 39N cm	ZRH8
	<b>62363</b>	320cm x 100cm x 40cm	ZRH4
	<b>62370</b>	320cm x 100cm x 48cm	ZR4
	<b>62413</b>	400cm x 72,5cm x 72W cm	ZR45
	<b>62420</b>	400cm x 72,5cm x 76W cm	ZR55



**CINGOLI IN GOMMA ADATTABILI A VARIE APPLICAZIONI**

CHENILLE CAOUTCHOUC ADAPTABLE DIVERSES APPLICATIONS

RUBBER TRACKING ADAPTABLE TO VARIOUS APPLICATIONS

GUMMIRAUPEN PASSEND ZU VERSCHIEDENE ANWENDUNGEN

ORUGA DE GOMA ADAPTABLE DIVERSAS APLICACIONES

Art./Ref.	Misura/Size
62204	180cm x 60cm x 31cm
84514	180cm x 60cm x 39cm
62222	190cm x 72cm x 37cm
62224	190cm x 72cm x 39cm
84519	190cm x 72cm x 42cm
84520	200cm x 72cm x 28cm
84525	200cm x 72cm x 43cm
62229	200cm x 72cm x 44cm
62233	230cm x 48cm x 62cm
62237	230cm x 48cm x 70cm
62249	230cm x 72cm x 54cm
84572	230cm x 96cm x 42cm
84573	230cm x 96cm x 43cm
62261	250cm x 52,5cm x 78K cm
62269	250cm x 72cm x 48cm
62270	250cm x 72cm x 49cm
84582	250cm x 109cm x 35cm
84584	250cm x 109cm x 37cm
84588	260cm x 109cm x 36cm
62318	300cm x 52,5cm x 74K cm
62326	300cm x 52,5cm x 78W cm
62330	300cm x 52,5cm x 82K cm
84594	300cm x 52,5cm x 86K cm
62340	300cm x 52,5cm x 88W cm
62351	300cm x 55cm x 70N cm
62295	300cm x 109cm x 38N cm
62301	300cm x 109cm x 40N cm
62306	300cm x 109cm x 42K cm
62307	300cm x 109cm x 42N cm
62310	300cm x 109cm x 43W cm
72634	320 X 52,5 X 80
84599	320cm x 52,5cm x 84N cm
84600	320cm x 54cm x 70cm
62376	320cm x 54cm x 72N cm
84603	320cm x 54cm x 80cm

Art./Ref.	Misura/Size
84605	320cm x 54cm x 84cm
62379	320cm x 84cm x 53B cm
62380	320cm x 86cm x 48cm
62371	320cm x 100cm x 49cm
62390	350cm x 52,5cm x 84cm
84614	350cm x 90cm x 47cm
62405	400cm x 72,5cm x 68K cm
62407	400cm x 72,5cm x 70K cm
62411	400cm x 72,5cm x 72KB cm
84618	400cm x 72,5cm x 76Y cm
84619	400cm x 74cm x 74cm
84620	400cm x 86cm x 50cm
84621	400cm x 86cm x 55cm
84622	400cm x 144cm x 35cm
84624	400cm x 144cm x 37cm
84625	400cm x 144cm x 38cm
62428	400cm x 100cm x 48cm
84626	400cm x 76cm x 82cm
62442	450cm x 81cm x 72N cm
62446	450cm x 81cm x 76N cm
84628	450cm x 81cm x 80W cm
84630	450cm x 81cm x 82N cm
84629	450cm x 81cm x 82W cm
84634	450cm x 83,5cm x 78cm
62453	450cm x 84cm x 53cm
62454	450cm x 84cm x 56cm
84635	450cm x 84cm x 74cm
84637	450cm x 86cm x 58B cm
84638	450cm x 86cm x 60B cm
84639	450cm x 90cm x 54cm
84641	450cm x 90cm x 69cm
84642	450cm x 90cm x 70cm
84646	450cm x 110cm x 74cm
84649	460cm x 102cm x 51cm

# 1.7.11 Zavorre per trattori

Ballasts for tractors



## Ricambi & accessori per macchine agricole

SPARE PARTS & ACCESSORIES FOR AGRICULTURAL MACHINE

Tutti gli articoli della presente sezione, prodotti da AMA SPA e/o da terzi per conto di AMA, sono adattabili ("non originali") alle marche indicate ai sensi di quanto previsto dal REG. CE n. 1400/2002. I diritti sui marchi citati appartengono ai legittimi proprietari ed il loro uso ha l'esclusiva finalità di consentire all'utilizzatore la comparazione dei diversi prodotti. All items of this section, manufactured by AMA SPA and/or any third party on behalf of AMA, are adaptable ("non-original") to the brands listed under the provisions of the REG. CE n. 1400/2002. The rights on the trademarks belong to their respective owners and their usage is only aimed to allow the user to compare different products.

**ZAVORRE IN GHISA PER TRATTORI ADATTABILI LANDINI**

MASSES D'ALOURDISSEMENT ADAPTABLE POUR TRACTEURS LANDINI  
 BALLASTS FOR TRACTORS ADAPTABLE LANDINI  
 BALLASTE AUS GUSS PASSEND ZU LANDINI  
 LASTRE DE HIERRO COLADO ADAPTABLE LANDINI

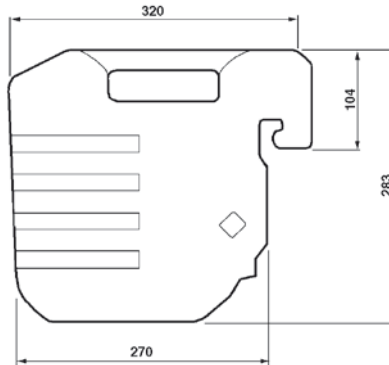

Art./Ref.	Peso Kg/Weight Kg	Brand	Applicazione/Application	Rif. Orig./Orig. Ref.
<b>00422</b>	28	<b>LANDINI</b>	VARI MODELLI	1424992M1

**ZAVORRA IN GHISA ORIGINALE LANDINI**

MASSE D'ALOURDISSEMENT ORIGINAL LANDINI  
 ORIGINAL LANDINI BALLAST  
 BALLASTE AUS GUSS ORIGINAL LANDINI  
 LASTRA DE HIERRO COLADO ORIGINAL LANDINI

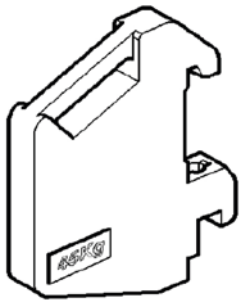

Art./Ref.	Peso Kg/Weight Kg	Note/Notes	Brand	Rif. Orig./Orig. Ref.
<b>LN3809692M91</b>	45	Larghezza 50 mm	<b>LANDINI</b>	3809692M91

**ZAVORRE IN GHISA PER TRATTORI ADATTABILI FIAT**

MESSES D'ALOURDISSEMENT ADAPTABLE POUR TRACTEURS FIAT

BALLASTS FOR TRACTORS ADAPTABLE FIAT

BALLASTE AUS GUSS PASSEND ZU FIAT

LASTRE DE HIERRO COLADO ADAPTABLE FIAT

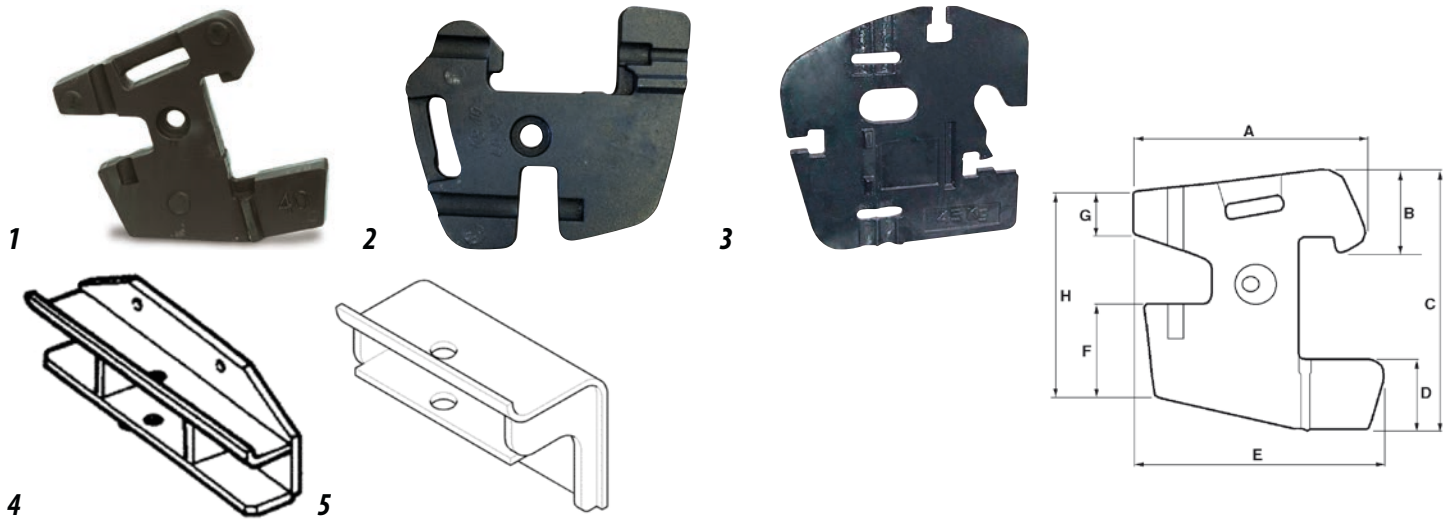

Art./Ref.	Peso Kg/ Weight Kg	Pos.	A mm	B mm	C mm	D mm	E mm	F mm	G mm	H mm	Brand	Applicazione/Application	Rif. Orig./ Orig. Ref.	
14257	25	1	300	75	-	115	325	50	110	220	FIAT	1280, 1380, 1580, 1880, 45.76 V, 50.86 V, 50.86 V DT, 50.865 V, 50.865 V DT, 55.76 F, 55.76 F DT, 55.76 V, 55.76 V DT, 55.86 F, 55.86 F DT, 55.86 V, 55.86 V DT, 55.865 V, 55.865 V DT, 60.76 F, 60.76 F DT, 60.86 F, 60.86 F DT, 60.86 V, 60.86 V DT, 60.865 V, 60.865 V DT, 62.86 F, 62.86 F DT, 70.76 F, 70.76 F DT, 70.76 LP, 70.76 LP DT, 70.76 V, 70.86 V, 70.86 V DT, 70.865 V, 70.865 V DT, 72.86 F, 72.86 F DT, 72.86 LP, 72.86 LP DT, 80.76 F, 80.76 F DT, 82.86 F, 82.86 F DT, 82.86 LP	44907891	
14255	33	1	380	90	370	100	420	100	50	250		55.46-55.46 DT, 55.56-55.56 DT, 55.66-55.66 DT, 55.665-55.665 DT, 55.88-55.88 DT, 570, 580, 60.46-60.46 DT, 60.56-60.56 DT, 60.66-60.66 DT, 60.665-60.665 DT, 60.665-60.665 DT, 60.88-60.88 DT, 60.93-60.93 DT, 60.94-60.94 DT, 65.46-65.46 DT, 65.56-65.56 DT, 65.66-65.66 DT, 65.665-65.665 DT, 65.88-65.88 DT, 65.93-65.93 DT, 65.94-65.94 DT, 670, 680, 70.56-70.56 DT, 70.66-70.66 DT, 70.665-70.665 DT, 70.88-70.88 DT, 72.93-72.93 DT, 72.94-72.94 DT, 780, 80.66-80.66 DT, 80.665-80.665 DT, 80.88-80.88 DT, 82.93-82.93 DT, 82.94-82.94 DT, 88.93-88.93 DT, 88.93-88.93 DT, 88.94-88.94 DT, 880, 980	5118650, 5163108	
85530	40	2	372	136	423	113	449	140	55	310		100.90-100.90 DT, 110.90-110.90 DT, 115.90-115.90 DT, 130.90-130.90 DT, 140.90-140.90 DT, 160.90-160.90 DT, 180.90-180.90 DT, 55.90-55.90 DT, 60.90-60.90 DT, 65.90-65.90 DT, 70.90-70.90 DT, 80.90-80.90 DT, 85.90-85.90 DT, 90.90-90.90 DT, F100-F100 DT, F110-F110 DT, F115-F115 DT, F120-F120 DT, F130-F130 DT, F140-F140 DT	5119079	
36809	45	3	-	-	-	-	-	-	-	-		-	-	82011619
26853	SUPPORTO ANTERIORE	4	-	-	-	-	-	-	-	-		-	-	44907885, 44909102
29992	SUPPORTO ANTERIORE	5	-	-	-	-	-	-	-	-		-	-	5177523, 5193793

**ZAVORRE IN GHISA PER TRATTORI ADATTABILI FORD**
*MESSES D'ALOURDISSEMENT ADAPTABLE POUR TRACTEURS FORD*
*BALLASTS FOR TRACTORS ADAPTABLE FORD*
*BALLASTE AUS GUSS PASSEND ZU FORD*
*LASTRE DE HIERRO COLADO ADAPTABLE FORD*

Art./Ref.	Peso Kg/Weight Kg	Pos.	A mm	B mm	C mm	D mm	E mm	F mm	G mm	H mm	Brand	Applicazione/Application	Rif. Orig./Orig. Ref.
<b>14257</b>	25	1	300	75	-	115	325	50	110	220	<b>FORD</b>	3830, 4030, 4230, 4430	44907891
<b>14255</b>	33	1	380	90	370	100	420	100	50	250		3010S, 4010S, 5010S	5163108
<b>36809</b>	45	3										8160, 8560, 8260, 8360	82011619

**ZAVORRE IN GHISA PER TRATTORI ADATTABILE JOHN DEERE**
*MESSES D'ALOURDISSEMENT ADAPTABLE POUR TRACTEURS JOHN DEERE*
*BALLASTS FOR TRACTORS ADAPTABLE JOHN DEERE*
*BALLASTE AUS GUSS PASSEND ZU JOHN DEERE*
*LASTRE DE HIERRO COLADO ADAPTABLE JOHN DEERE*

Art./Ref.	Peso Kg/Weight Kg	Note/Notes	Brand	Applicazione/Application	Rif. Orig./Orig. Ref.
<b>10780</b>	50	SX	<b>JOHN DEERE</b>	SERIE 6000, SERIE 7000, SERIE 8000	L38449
<b>11656</b>		DX		SERIE 6000, SERIE 7000, SERIE 8000	L38450

**ZAVORRE IN GHISA PER TRATTORI ADATTABILI NEW HOLLAND**

MESSES D'ALOURDISSEMENT ADAPTABLE POUR TRACTEURS NEW HOLLAND

BALLASTS FOR TRACTORS ADAPTABLE NEW HOLLAND

BALLASTE AUS GUSS PASSEND ZU NEW HOLLAND

LASTRE DE HIERRO COLADO ADAPTABLE NEW HOLLAND



Art./Ref.	Peso Kg/Weight Kg	Pos.	A mm	B mm	C mm	D mm	E mm	F mm	G mm	H mm	Brand	Applicazione/Application	Rif. Orig./Orig. Ref.
14257	25	1	300	75	-	115	325	50	110	220	NEW HOLLAND	T4020V, T4030F, T4030N, T4030V, T4040F, T4040N, T4040V, T4050F, T4050N, T4050V, T4060F, T4060N, T4060V, TN55V, TN60VA, TN65F, TN65N, TN65V, TN70F, TN70NA, TN70VA, TN75F, TN75FA, TN75N, TN75NA, TN75V, TN75VA, TN80F, TN85FA, TN90F, TN95F, TN95FA, TN95NA, TN95VA	5177533
85530	40	2	372	136	423	113	449	140	55	310		T4020-T4030-T4040-T4050, T4030F-T4040F-T4050F-T4060F, T5.105-T5.95-T5.115, T5030-T5040-T5050-T5060-T5070, TD55D-TD60D-TD65D-TD70D-TD75D, TD60-TD70-TD80-TD85D-TD90-TD95, TD80D-TD90D-TD95D, TK160.55, TL55F-TL65F-TL75F, TL60-TL65-TL70-TL75-TL80-TL85, TL60E-TL75E-TL85E-TL95E, TL70A-TL80A-TL90A-TL100A, TL90-TL95-TL100, TN60A-TN70A-TN75A, TN60A-TN70A-TN75A-TN85A-TN95A, TN60DA-TN70DA-TN75DA-TN85DA, TN60SA-TN70SA-TN75SA-TN85SA, TN75A, TN75FA-TN85FA-TN95FA, TN95DA, TS120-TS125, TS90-TS100-TS110	47133570, 5093382, 5199608
36809	45	3										M115-M135-M160, TM115, TM120, TM130, TM150, TM125, TM135, TM140, TM155, TM165, TM175, TM190, TS100, TS110, TS115, TS80, TS90, TV140	82011619, 87353832

**ZAVORRE IN GHISA PER TRATTORI ADATTABILE SAME LAMBORGHINI HURLIMANN**

MASSES D'ALOURDISSEMENT ADAPTABLE SAME LAMBORGHINI HURLIMANN

BALLASTS FOR TRACTORS ADAPTABLE SAME LAMBORGHINI HURLIMANN

BALLASTE AUS GUSS PASSEND ZU SAME LAMBORGHINI HURLIMANN

LASTRE DE HIERRO COLADO ADAPTABLE SAME LAMBORGHINI HURLIMANN

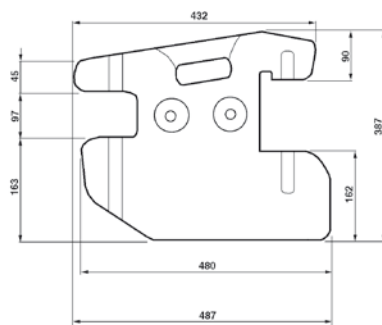

Art./Ref.	Peso Kg/Weight Kg	Brand	Applicazione/Application	Rif. Orig./Orig. Ref.
00424	40	SAME LAMBORGHINI HURLIMANN	ANTARES 110 II, ANTARES 130 II, ARGON 50, ARGON 60, ARGON 70, ASTER 60, ASTER 70, DORADO 60, DORADO 70, EXPLORER 60 II, EXPLORER 60 II SPECIAL, EXPLORER 70 II, EXPLORER 70 II BASSO SPECIAL, EXPLORER 70 II SPECIAL, EXPLORER 70 SPECIAL-> 15500, EXPLORER 80 II, EXPLORER 80 II BASSO SPECIAL, EXPLORER 80 SPECIAL LP, EXPLORER 80 SPECIAL-> 15000, EXPLORER 90 SPECIAL LP, EXPLORER 90 SPECIAL-> 2500, EXPLORER 90T II, FRUTTETO 60 II, FRUTTETO 75 II, FRUTTETO 85 II, GOLDEN 60 COMPATTO, GOLDEN 65 COMPATTO, GOLDEN 75 COMPATTO, GOLDEN 85 COMPATTO, LASER 100, LASER 110, LASER 130, LASER 150, LASER TRANSPORTER 85, ROCK 55, ROCK 60, ROCK 70, ROW CROP 90	0.96929.40.0/10, 0.96929.40.0/20

# 1.7.12 Carrozzeria, vernici, cristalli e maniglie

Body, paints, glasses and handles



## Ricambi & accessori per macchine agricole

SPARE PARTS & ACCESSORIES FOR AGRICULTURAL MACHINE

Tutti gli articoli della presente sezione, prodotti da AMA SPA e/o da terzi per conto di AMA, sono adattabili ("non originali") alle marche indicate ai sensi di quanto previsto dal REG. CE n. 1400/2002. I diritti sui marchi citati appartengono ai legittimi proprietari ed il loro uso ha l'esclusiva finalità di consentire all'utilizzatore la comparazione dei diversi prodotti. All items of this section, manufactured by AMA SPA and/or any third party on behalf of AMA, are adaptable ("non-original") to the brands listed under the provisions of the REG. CE n. 1400/2002. The rights on the trademarks belong to their respective owners and their usage is only aimed to allow the user to compare different products.

**COFANATURE ADATTABILI FIAT SERIE ORO**

COUVRE-CAPOT MOTEUR ADAPTABLE FIAT

ENGINE HOOD-CUP ADAPTABLE FIAT

MOTORHAUBE PASSEND ZU FIAT-SCHLEPPER

TAPA CAPO' ADAPTABLE FIAT

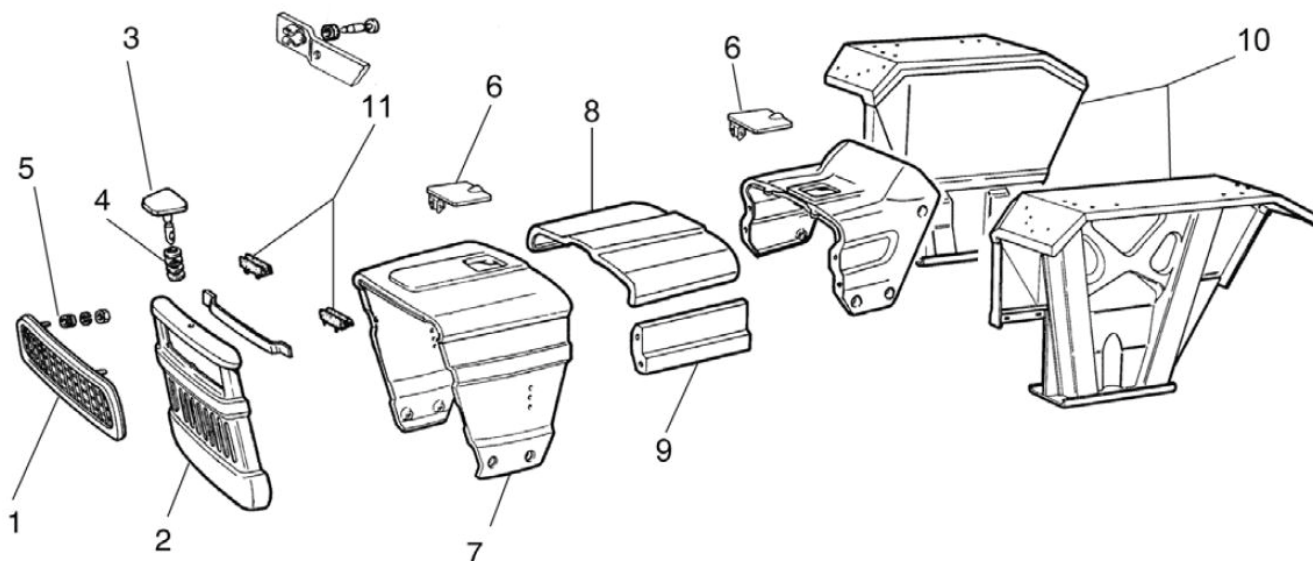

Art./Ref.	Pos.	Descrizione/Description	Brand	Applicazione/Application	Rif. Orig./Orig. Ref.
01057	1	Mascherina/Front grill	FIAT	450, 480, 500, 540, 550, 605, 640, 805	4950441, 4956270, 5011646
04624	2	Calandra radiatore/Radiator Cover	FIAT	440, 450, 480, 500, 540, 640	4950401
19133	3	Perno/Pin	FIAT	1300R, 450DT, 450R, 640DT	4950422
15816	4	Molla/Spring	FIAT	1000DT, 1300, 450, 605C	4950423
12724	6	Sportellino superiore/Upper door	FIAT	100.90-100.90 DT, 110.90-110.90 DT, 115.90-115.90 DT, 130.90-130.90 DT, 140.90-140.90 DT, 160.90-160.90 DT, 180.90-180.90 DT, 1880DT, 35.66-35.66 DT, 45.66-45.66 DT, 45.66S-45.66S DT, 450R, 50.66-50.66 DT, 50.66S-50.66S DT, 55.90-55.90 DT, 56.66S-56.66S DT, 580DT, 60.90-60.90 DT, 640DT, 65.90-65.90 DT, 65.94-65.94 DT, 70.90-70.90 DT, 72.94-72.94 DT, 780DT, 80.90-80.90 DT, 82.94-82.94 DT, 85.90-85.90 DT, 88.94-88.94 DT, 90.90-90.90 DT, F100-F100 DT, F100.F100 DT, F110-F110 DT, F115-F115 DT, F120-F120 DT, F130-F130 DT, F140-F140 DT, FORD 3435-3935-4135, FORD 8430-8630-8830, NH FD10, NH FD14, NH TK100.55, NH TK160.55, NH TK60.75, NH TK60.75 M, NH TK62.85, NH TK62.85 M, NH TK70.75, NH TK70.75 M, NH TK72.85, NH TK72.85 M, NH TK80.75, NH TK82.85 M, NH TK85.55, NH TK88.85 M, NH TK95.55	596567
04627	7	Cofano motore/Engine bonnet	FIAT	440, 450, 480, 500, 540, 605, 640, 650, 750, 805	4953308, 599112
04605	8	Coperchio motore/Engine hood	FIAT	605, 640	4950900
04606	9	Fianco motore destro/Engine bonnet right	FIAT	640	4950907
04607	9	Cofano motore sinistro/Engine bonnet left	FIAT	640	4950909
04628	10	Parafango posteriore destro. H=770mm/Right rear mudguard. H=770mm	FIAT	440, 450, 480, 640	4999764
04629	10	Parafango posteriore sinistro. H=770mm/Left rear mudguard. H=770mm	FIAT	440, 450, 480, 640	4999766
05699	10	Parafango posteriore destro, assale tondo/Right rear mudguard, round axle	FIAT	450, 480, 500, 550, 600, 640	598847
05694	10	Parafango posteriore sinistro, assale tondo/Left rear mudguard, round axle	FIAT	450, 480, 500, 550, 600, 640	598848
16392	11	Guarnizione/Sealing	FIAT	655C, 805C	4954150, 599968



**CALANDRE E GRIGLIE ADATTABILI**

CALANDRES ET GRILLES ADAPTABLE  
 FRONT GRILLS AND GRIDS ADAPTABLE  
 KALANDER UND GRIDS PASSEND ZU  
 CALANDRA COMPLETA Y ADAPTABLE

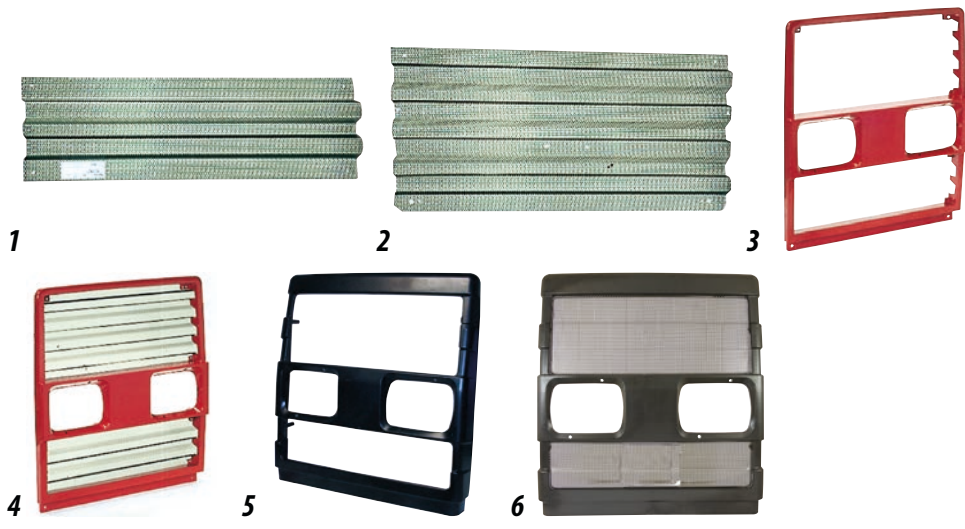

Art./Ref.	Pos.	Descrizione/Description	Brand	Applicazione/Application	Rif. Orig./Orig. Ref.
17087	1	Griglia inferiore	FIAT	100-90, 100-90DT, 110-90, 110-90DT, 55-90, 55-90DT, 60-90, 60-90DT, 65-90, 65-90DT, 70-90, 70-90DT, 80-90, 80-90DT, 85-90, 85-90DT, 90-90, 90-90DT	5119772
17089	2	Griglia superiore		100-90, 100-90DT, 110-90, 110-90DT, 55-90, 55-90DT, 60-90, 60-90DT, 65-90, 65-90DT, 70-90, 70-90DT, 80-90, 80-90DT, 85-90, 85-90DT, 90-90, 90-90DT	5119771
26503		Griglia radiatore		115.90, 130.90, 140.90, 160.90, 180.90	5132245, 5171767
17088	3	Griglia radiatore nuda		100.90, 100.90DT, 110.90, 110.90DT, 90-90, 90-90DT	44905506, 44905526, 5119913
17094	4	Calandra radiatore		100.55C, 100.90, 100.90DT, 110.90, 110.90DT, 55-90, 55-90DT, 60-90, 60-90DT, 65-90, 65-90DT, 70-90, 70-90DT, 80-90, 80-90DT, 85-90, 85-90DT, 90-90, 90-90DT	5119890
58056	5	Calandra nuda senza griglie/ Front grill without grids		55-66S, 55-66S DT, 60-66S, 60-66S DT, 60-93, 60-93 DT, 60-94, 60-94 DT, 65-66S, 65-66S DT, 65-93, 65-93 DT, 65-94, 65-94 DT, 70-66S, 70-66S DT, 72-93, 72-93 DT, 72-94, 72-94 DT, 80-66S, 82-93, 82-93 DT, 82-94, 82-94 DT, 88-93, 88-93 DT, 88-94, 88-94 DT	5169647
59786	6	Calandra completa/ Complete front grill	55-66S, 55-66S DT, 60-66S, 60-66S DT, 60-93, 60-93 DT, 60-94, 60-94 DT, 65-66S, 65-66S DT, 65-93, 65-93 DT, 65-94, 65-94 DT, 70-66S, 70-66S DT, 72-93, 72-93 DT, 72-94, 72-94 DT, 80-66S, 82-93, 82-93 DT, 82-94, 82-94 DT, 88-93, 88-93 DT, 88-94, 88-94 DT	5169647	
17087	1	Griglia inferiore	NEW HOLLAND	TK85-55, TK95-55	5132658, 5175977
17089	2	Griglia superiore		TK85-55, TK95-55	5132244, 5175978
17094	4	Calandra radiatore		TK100-55, TK85-55, TK95-55	5132683, 5175979
58056	5	Calandra nuda senza griglie/ Front grill without grids		TK62-85, TK62-85 M, TK72-85, TK72-85 M, TK82-85 M, TK88-85 M	5169647
59786	6	Calandra completa/Complete front grill		TK62-85, TK62-85 M, TK72-85, TK72-85 M, TK82-85 M, TK88-85 M	5169647

**CINGHIETTA ADATTABILE**

COURROIE ADAPTABLE  
COVER BELT ADAPTABLE  
KOFFERRIEMEN PASSEND ZU  
CORREAS ADAPTABLE



Art./Ref.	Brand	Applicazione/Application	Rif. Orig./Orig. Ref.
<b>08495</b>	<b>FIAT</b>	100.90-100.90 DT, 110.90-110.90 DT, 115.90-115.90 DT, 1180, 1280, 130.90 130.90DT, 1380, 140.90 140.90DT, 140.90-140.90 DT, 1580, 160.90-160.90 DT, 180.90-180.90 DT, 1880, 474, 55.46, 55.46 DT, 55.56-55.56 DT, 55.66, 55.66 DT, 55.90-55.90 DT, 565, 566, 570, 60.46-60.46 DT, 60.56 DT, 60.65, 60.66, 60.66 DT, 60.90-60.90 DT, 65.46, 65.46 DT, 65.56, 65.56 DT, 65.66, 65.66 DT, 665, 666, 670, 70.56-70.56 DT, 70.65, 70.66, 70.66 DT, 70.90-70.90 DT, 765, 766, 80.46, 80.65, 80.66, 80.66 DT, 80.90-80.90 DT, 90.90-90.90 DT	4999154, 5106362
<b>08495</b>	<b>NEW HOLLAND</b>	TK55.65 F, TK55.65 M, TK55.65 V, TK60.65, TK60.65 M, TK60.65 V, TK60.75, TK60.75 M, TK60.75 V, TK70.65, TK70.65 M, TK70.75, TK70.75 M, TK80.65, TK80.66 DT, TK80.75	4999154, 5106362

**COFANATURE ADATTABILI MASSEY FERGUSON**

COUVRE-CAPOT MOTEUR ADAPTABLE MASSEY FERGUSON  
ENGINE HOOD ADAPTABLE MASSEY FERGUSON  
MOTORHAUBE PASSEND ZU MASSEY FERGUSON  
TAPA CAPO ADAPTABLE MASSEY FERGUSON

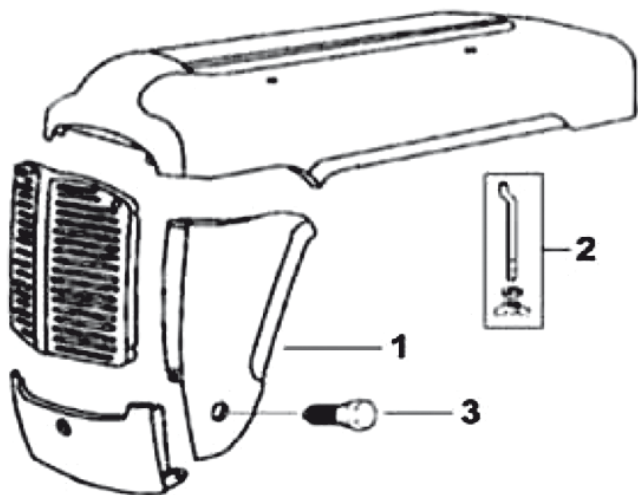

Art./Ref.	Pos.	Descrizione/Description	Brand	Applicazione/Applicazione	Rif. Orig./Orig. Ref.
<b>42045</b>	1	Pannello laterale destro/Right side pannel	<b>MASSEY FERGUSON</b>	FE35	826815M91
<b>42046</b>	1	Pannello laterale sinistro/Left side panel		FE35	826816M91
<b>42049</b>	2	Asta cofano/Hood catch rod		FE35	826870M1
<b>42048</b>	3			FE35	180718M1

**PARAFANGHI ADATTABILI MASSEY FERGUSON**

GARDE BOUE ADAPTABLE MASSEY FERGUSON  
 FENDERS ADAPTABLE MASSEY FERGUSON  
 KOTFLUEGEL PASSEND ZU MASSEY FERGUSON  
 GUARDABARROS ADAPTABLE MASSEY FERGUSON

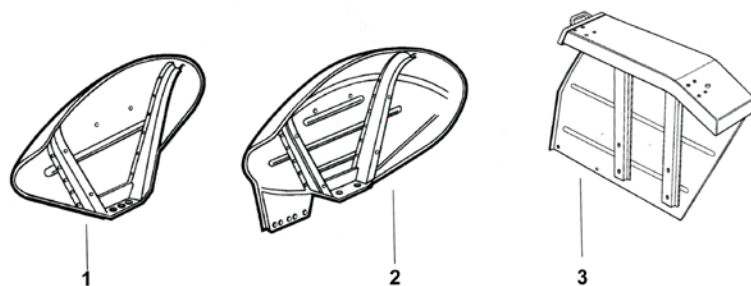

Art./Ref.	Pos.	Descrizione/Description	Note/Notes	Brand	Applicazione/Application	Rif. Orig./Orig. Ref.
42062	1	Parafango dx/sx/ Fender right/left		<b>MASSEY FERGUSON</b>	FE35,35, TEA20, TED20, TEF20	1883356M92
42063	2	Parafango sinistro/ Fender left	Con prolunga di sicurezza/With safety extension		230, 240, 250, 253, FE35,35, TEA20, TED20, TEF20	1884287M97
42064	2	Parafango destro/ Right fender	Con prolunga di sicurezza/With safety extension		230, 240, 250, 253, FE35,35, TEA20, TED20, TEF20	1884286M97
42065	3	Parafango sinistro/ Left fender			230, 240, 250, 265, 275, 290, 298	1679374M92
42066	3	Parafango destro/ Right fender			230, 240, 250, 265, 275, 290, 298	1679373M92

**PARAFANGHI CORTI PER RUOTE ANTERIORI DEI TRATTORI**

GARDE - BOUE COURT POUR TRACTEUR  
 SHORT MUDGUARD FOR TRACTORS  
 KÜRZE KOTLEDER FÜR TRAKTOREN  
 GUARDABARROS CORTO PARA TRACTORES

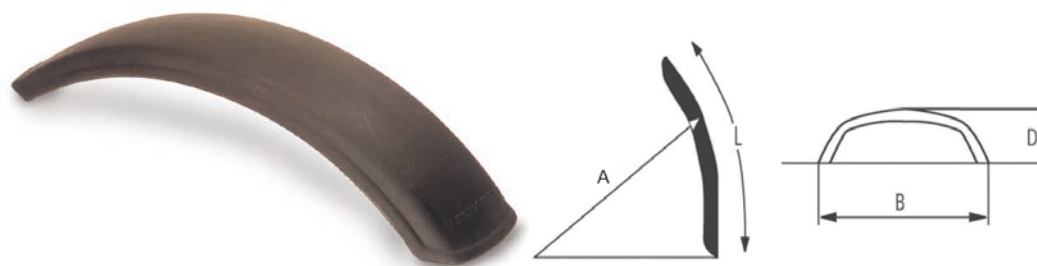

Art./Ref.	A mm	B mm	D mm	Lunghezza mm/Lenght mm	Tipo Pneumatico/Tyre type	Peso Kg/Weight Kg
12343	440	185	40	700	5.00+5.50+6.00-16, 6.00-19	0.6
12344	530	225	32	810	6.00+6.50+7.50-16, 9.00-16, 7.50-18, 7.50-18, 7.5 L15	0.9
12370	520	240	40	925	6.00+6.50 +7.50-20, 9.5-20, 8.3-24	1.1
12371	615	265	45	1000	9.5-24+28, 8.3-28, 10.5-18	1.2
12372	660	310	45	1070	11.2-24+28, 10.5-20	1.6
12373	660	355	45	1085	12.4-24, 13.6-24, 12.5-18+20	1.9
12374	720	355	45	1245	12.4-28+32, 13.6-28	2.1
12375	720	400	40	1315	13.6-28, 14.9-24+26+28+30	2.7
12376	720	410	45	1250	13.6-28	2.4
12377	780	470	50	1300	16.9-24+26, 18.4/70-28	2.9

**CRISTALLO ANTERIORE ADATTABILE**

VITRE AVANT ADAPTABLE  
FRONTAL GLASS SUITABLE  
FRONTSCHIEBE PASSEND ZU  
CRISTAL ANTERIOR COMPATIBLE

Art./Ref.	Note/Notes	Brand	Applicazione/Application	Rif. Orig./Orig. Ref.	Immagine/Image
91469	Regolabile//Tilttable	CASE	JX-U100, JX-U1070, JX-U1080,, JX-U1090, JX-U1100, JX-U70, JX-U80, JX-U90,	82003391, 84283801	
91468	Fisso//Fixed		JX-U100, JX-U1070, JX-U1080, JX-U1090, JX-U1100, JX-U70, JX-U80, JX-U90,	82002183	
91473	Regolabile//Tilttable		MXM120, MXM130, MXM140,, MXM155, MXM175, MXM190	82000488	
91474	Fisso//Fixed		MXM120, MXM130, MXM140,, MXM155, MXM175, MXM190	82000296	
91537	Regolabile//Tilttable		JX1060, JX1070, JX1075, QUANTUM 65, QUANTUM 75,, QUANTUM 85, QUANTUM 95,	44911501	
91541	Regolabile//Tilttable		MAXXUM 100, MAXXUM 110,, MAXXUM 115, MAXXUM 125,, MAXXUM 140, MXU 100, MXU 110,, MXU 115, MXU 125, MXU 135	82032042	
91542	Regolabile//Tilttable		CS130, CS150, CS78, CS80, CS85, CS86, CS90,, CS94, CS105, CS110, CS120,, CVX1155, CVX1170, CVX1190, CVX120, CVX130, CVX150, CVX170, CVX195, CVX1135, CVX1145,	134671060, 134671090, 47110838	
91493	Fisso//Fixed	DEUTZ	AGROSUN 100, AGROSUN 120,, AGROSUN 140	0.9234.210.0/30	

Art./Ref.	Note/Notes	Brand	Applicazione/Application	Rif. Orig./Orig. Ref.	Immagine/Image
91499	Regolabile//Tilttable	DEUTZ	AGROTON NEW 90, AGROTON NEW100, AGROTON NEW105, AGROTON NEW108, AGROTON NEW110, AGROTON NEW118, AGROTON NEW120, AGROTON NEW128, AGROTRON 4.70, AGROTRON 4.80,, AGROTRON 4.85, AGROTRON 4.90,, AGROTRON 4.95, AGROTRON 6.00,, AGROTRON 6.01, AGROTRON 6.05,, AGROTRON 6.15, AGROTRON 6.20,, AGROTRON 6.30, AGROTRON 6.45,, AGROTRON MK3 100, AGROTRON MK3 105, AGROTRON MK3 106, AGROTRON MK3 110, AGROTRON MK3 115, AGROTRON MK3 120, AGROTRON MK3 135, AGROTRON MK3 150, AGROTRON MK3 160, AGROTRON MK3 175, AGROTRON MK3 200, AGROTRON MK3 230, AGROTRON MK3 260, AGROTRON MK3 80, AGROTRON MK3 85, AGROTRON MK3 90, M600, M610, AGROTRON NEW 80,	04418946	
91468	Fisso//Fixed	FORD	4635, 4835, 5635, 6635, 7635	82002183	
91469	Regolabile//Tilttable		4635, 4835, 5635, 6635, 7635	82003391, 84283801	
91473	Regolabile//Tilttable		8160, 8260, 8360, 8560	82000488	
91526	Fisso//Fixed		8160, 8260, 8360, 8560	82011530	
91524	Regolabile//Tilttable		580, 680, 780, 880, 980	5108663, 5123300, 5126498	
91493	Fisso//Fixed	HURLIMANN	SIAC H496, SIAC H5116,, SIAC H6136, SIAC H6170	0.9234.210.0/30	
91493	Fisso//Fixed	LAMBORGHINI	GALAXY 170, LASER 130, LASER 150, LASER160, LASER 90, LASER 100, LASER 110, R1306, R1306 TURBO, LASER 85, SLH 956-100, R956, R1106,	0.9234.210.0/30	
91531	Fisso//Fixed		GRAND PRIX 674-70, GRAND PRIX 874,90	0.9241.210.0/10	

Art./Ref.	Note/Notes	Brand	Applicazione/Application	Rif. Orig./Orig. Ref.	Immagine/Image
91468	Fisso//Fixed	<b>NEW HOLLAND</b>	T5040, T5050, T5060, T5070, TL80, TL90, TL100, T5030,, TLA 100A, TLA 70A, TLA 80A, TLA 90A,	82002183	
91469	Regolabile//Tiltable		T5040, T5050, T5060, T5070, TL80, TL90, TL100, T5030,	82003391, 84283801	
91473	Regolabile//Tiltable		TM115, TM120, TM125, TM130,, TM135, TM140, TM150, TM155,, TM165, TM175, TM190	82000488	
91474	Fisso//Fixed		TM115, TM120, TM125, TM130,, TM135, TM140, TM150, TM155,, TM165, TM175, TM190	82000296	
91526	Fisso//Fixed		TL80, TL90, TL100, TS90, TS100, TS110, TS115,	82011530	
91537	Regolabile//Tiltable		T4020, T4030, T4040, T4050, TN55, TN60, TN70, TN75, TN85, TN95	44911501	
91541	Regolabile//Tiltable		T6.155, T6.120, T6.140, T6.150, T6.160, T6.165, T6.175, T6020, T3010, T6030, T6040,, T6050, T6060, T6070, T6080,, T6090, T7030, T7040, T7060, TS100, TS110, TS115, TS125,, TS130, TS135	82032042	
91542	Regolabile//Tiltable		T7520, T7530, T7540, T7550, TVT135, TVT145, TVT155, TVT170, TVT190, TVT195	134671060, 134671090, 47110838	
59762	Fisso//Fixed		<b>SAME LAMBORGHINI HURLIMANN</b>	EXPLORER 55-60-65-70-75-80, EXPLORER 90TURBO - II 90 TURBO, HURLIMAN 356-358, HURLIMAN 446-468-476-478-488	0.9231.210.0/10

Art./Ref.	Note/Notes	Brand	Applicazione/Application	Rif. Orig./Orig. Ref.	Immagine/Image
91531	Fisso//Fixed	<b>SAME</b>	ANTARES 100, EXPLORER 100, EXPLORER 40, EXPLORER 50,, EXPLORER 60, EXPLORER 70,, EXPLORER 75, EXPLORER 80,, EXPLORER 90, EXPLORER 95,	0.9241.210.0/10	
91537	Regolabile//Tiltable	<b>STEYR</b>	KOMPAKT 360, KOMPAKT 370, KOMPAKT 375, KOMPAKT 485, KOMPAKT 4075, KOMPAKT 4085, KOMPAKT 4095, KOMPAKT 495, KOMPAKT 4065	44911501	
91541	Regolabile//Tiltable		PROFI 4100, 41	82032042	
91542	Regolabile//Tiltable		M9078, M9080, M9083, M9086,, M9090, M9094, M9100, M9105,, M9115, M9125	134671060, 134671090, 47110838	

**CRISTALLO ANTERIORE BASSO ADATTABILE**

VITRE AVANT BAS ADAPTABLE  
 LOWER FRONT GLASS SUITABLE  
 FRONTSCHIEBE PASSEND ZU  
 CRISTAL ANTERIOR BAJO COMPATIBLE

Art./Ref.	Note/Notes	Brand	Applicazione/Application	Rif. Orig./Orig. Ref.	Immagine/Image
91470	Destro//Right	<b>CASE</b>	JX-U100, JX-U1070, JX-U1080,, JX-U1090, JX-U1100, JX-U70, JX-U80, JX-U90,	47125737	
91471	Sinistro//Left		JX-U100, JX-U1070, JX-U1080,, JX-U1090, JX-U1100, JX-U70, JX-U80, JX-U90,	47125738	

Art./Ref.	Note/Notes	Brand	Applicazione/Application	Rif. Orig./Orig. Ref.	Immagine/Image
91475	Destro//Right	CASE	MXM120, MXM130, MXM140,, MXM155, MXM175, MXM190	82001924	
91476	Sinistro//Left		MXM120, MXM130, MXM140,, MXM155, MXM175, MXM190	82001923	
91477	Destro//Right		JX55, JX60, JX65, JX70, JX75,, JX80, JX85, JX90, JX95	5092900	
91478	Sinistro//Left		JX55, JX60, JX65, JX70, JX75,, JX80, JX85, JX90, JX95	5089554	
91486	Destro//Right		MAXXUM 110, MAXXUM 115,, MAXXUM 125, MAXXUM 140, MXU100, MXU110, MXU115, MXU125, MXU125, MXU135, MXU140, MXU135, MXU140, MAXXUM 100,	82030485	
91487	Sinistro//Left		MAXXUM 110, MAXXUM 115,, MAXXUM 125, MAXXUM 140, MXU100, MXU110, MXU115, MXU125, MXU125, MXU135, MXU140, MXU135, MXU140, MAXXUM 100,	82030486	
91488	Destro//Right		MAXXUM 110, MAXXUM 115,, MAXXUM 125, MAXXUM 140, MXU100, MXU110, MXU115, MXU125, MXU125, MXU135, MXU140, MXU135, MXU140, MAXXUM 100,	82030487	



Art./Ref.	Note/Notes	Brand	Applicazione/Application	Rif. Orig./Orig. Ref.	Immagine/Image
91489	Sinistro//Left	CASE	MAXXUM 110, MAXXUM 115,, MAXXUM 125, MAXXUM 140, MXU100, MXU110, MXU115, MXU125, MXU125, MXU135, MXU140, MXU135, MXU140, MAXXUM 100,	82030488	
91547	Destro//Right		1135, 1145, 1155, 1170, 1190, CS120, CS130, CS150, CS78, CS80, CS85, CS86, CS90,, CS94, CS100, CS105, CS110,, CVX120, CVX130, CVX140, CVX150, CVX160, CVX170, CVX195	134671099	
91548	Sinistro//Left		1135, 1145, 1155, 1170, 1190, CS120, CS130, CS150, CS78, CS80, CS85, CS86, CS90,, CS94, CS100, CS105, CS110,, CVX120, CVX130, CVX140, CVX150, CVX160, CVX170, CVX195	134671080	
91494	Destro - sinistro	LAMBORGHINI	GALAXY 170, LASER 130, LASER 150, LASER160, LASER 90, LASER 100, LASER 110, R1306, R1306 TURBO, LASER 85, SLH 956-100, R956, R1106,	0.9234.212.0/20	
91500	Destro//Right	DEUTZ	AGROTON NEW 90, AGROTON NEW100, AGROTON NEW105, AGROTON NEW108, AGROTON NEW110, AGROTON NEW118, AGROTON NEW120, AGROTON NEW128, AGROTRON 4.70, AGROTRON 4.80,, AGROTRON 4.85, AGROTRON 4.90,, AGROTRON 4.95, AGROTRON 6.00,, AGROTRON 6.01, AGROTRON 6.05,, AGROTRON 6.15, AGROTRON 6.20,, AGROTRON 6.30, AGROTRON 6.45,, AGROTRON MK3 100, AGROTRON MK3 105, AGROTRON MK3 106, AGROTRON MK3 110, AGROTRON MK3 115, AGROTRON MK3 120, AGROTRON MK3 135, AGROTRON MK3 150, AGROTRON MK3 160, AGROTRON MK3 175, AGROTRON MK3 200, AGROTRON MK3 230, AGROTRON MK3 260, AGROTRON MK3 80, AGROTRON MK3 85, AGROTRON MK3 90, M600, M610, AGROTRON NEW 80,	04429884	
91501	Sinistro//Left		AGROTON NEW 90, AGROTON NEW100, AGROTON NEW105, AGROTON NEW108, AGROTON NEW110, AGROTON NEW118, AGROTON NEW120, AGROTON NEW128, AGROTRON 4.70, AGROTRON 4.80,, AGROTRON 4.85, AGROTRON 4.90,, AGROTRON 4.95, AGROTRON 6.00,, AGROTRON 6.01, AGROTRON 6.05,, AGROTRON 6.15, AGROTRON 6.20,, AGROTRON 6.30, AGROTRON 6.45,, AGROTRON MK3 100, AGROTRON MK3 105, AGROTRON MK3 106, AGROTRON MK3 110, AGROTRON MK3 115, AGROTRON MK3 120, AGROTRON MK3 135, AGROTRON MK3 150, AGROTRON MK3 160, AGROTRON MK3 175, AGROTRON MK3 200, AGROTRON MK3 230, AGROTRON MK3 260, AGROTRON MK3 80, AGROTRON MK3 85, AGROTRON MK3 90, M600, M610, AGROTRON NEW 80,	04429882	
91494	Destro - sinistro		AGROSUN 100, AGROSUN 120,, AGROSUN 140		

Art./Ref.	Note/Notes	Brand	Applicazione/Application	Rif. Orig./Orig. Ref.	Immagine/Image
91475	Destro//Right	FIAT	M100, M115, M135, M160	82001924	
91476	Sinistro//Left		M100, M115, M135, M160	82001923	
59759	Destro//Right	FORD	4635, 4835, 5635, 6635, 7635	82002184	
59761	Sinistro//Left		4635, 4835, 5635, 6635, 7635	82002185	
91475	Destro//Right		8160, 8260, 8360, 8560	82001924	
91476	Sinistro//Left		8160, 8260, 8360, 8560	82001923	
59759	Destro//Right/	NEW HOLLAND	L60, L65, L75, L85, L95, TL100, TL55F-TL65F-TL75F, TL65, TL65A, TL70, TL80, TL90	82002184	
59761	Sinistro//Left		L60, L65, L75, L85, L95, TL100, TL55F-TL65F-TL75F, TL65, TL65A, TL70, TL80, TL90	82002185	

Art./Ref.	Note/Notes	Brand	Applicazione/Application	Rif. Orig./Orig. Ref.	Immagine/Image
91470	Destro//Right	NEW HOLLAND	T5030, T5040, T5050, T5060,, T5070, TL70, TL80, TL90, TL100	47125737	
91471	Sinistro//Left		T5030, T5040, T5050, T5060,, T5070	47125738	
91475	Destro//Right		TM115, TM120, TM125, TM130,, TM135, TM140, TM150, TM155,, TM165, TM175, TM190	82001924	
91476	Sinistro//Left		TM115, TM120, TM125, TM130,, TM135, TM140, TM150, TM155,, TM165, TM175, TM190	82001923	
91477	Destro//Right		TD55, TD60, TD65, TD70, TD75, TD80, TD85, TD90, TD95	5092900	
91478	Sinistro//Left		TD55, TD60, TD65, TD70, TD75, TD80, TD85, TD90, TD95	5089554	
91486	Destro//Right		T6.120, T6.140, T6.150, T6.155, T6.160, T6.165, T6.175, T6010, T6020, T6030, T6040, T6050, T6060, T6070, T6080, T6090, T7030, T7040, T7060, TS-A100, TS-A110, TS-A115, TS-A125,, TS-A130, TS-A135	82030485	

Art./Ref.	Note/Notes	Brand	Applicazione/Application	Rif. Orig./Orig. Ref.	Immagine/Image
91487	Sinistro//Left	NEW HOLLAND	T6.120, T6.140, T6.150, T6.155, T6.160, T6.165, T6.175, T6010, T6020, T6030, T6040, T6050, T6060, T6070, T6080, T6090, T7030, T7040, T7060, TS-A100, TS-A110, TS-A115, TS-A125,, TS-A130, TS-A135	82030486	
91488	Destro//Right		T6.120, T6.140, T6.150, T6.155, T6.160, T6.165, T6.175, T6010, T6020, T6030, T6040, T6050, T6060, T6070, T6080, T6090, T7030, T7040, T7060, TS-A100, TS-A110, TS-A115, TS-A125,, TS-A130, TS-A135	82030487	
91489	Sinistro//Left		T6.120, T6.140, T6.150, T6.155, T6.160, T6.165, T6.175, T6010, T6020, T6030, T6040, T6050, T6060, T6070, T6080, T6090, T7030, T7040, T7060, TS-A100, TS-A110, TS-A115, TS-A125,, TS-A130, TS-A135	82030488	
91527	Destro//Right		TS90, TS100, TS110, TS115	82011532	
91528	Sinistro//Left		TS90, TS100, TS110, TS115	82011531	
91547	Destro//Right		T7520, T7530, T7540, T7550, TVT135, TVT145, TVT155, TVT170, TVT190, TVT195	134671099	
91548	Sinistro//Left		T7520, T7530, T7540, T7550, TVT135, TVT145, TVT155, TVT170, TVT190, TVT195	134671080	

Art./Ref.	Note/Notes	Brand	Applicazione/Application	Rif. Orig./Orig. Ref.	Immagine/Image
91547	Destro//Right	STEYR	M9078, M9086, M9094, M9105, M9115, M9125, M9145	134671099	
91548	Sinistro//Left		CVT120, CVT130, CVT150, CVT170, M9078, M9083, M9086	134671080	

**CRISTALLO PORTIERA ADATTABILE**

VITRE DE PORTE ADAPTABLE  
 DOOR GLASS SUITABLE  
 TURSCEIBE PASSEND ZU  
 VENTANILLA DE PUERA COMPATIBLE

Art./Ref.	Note/Notes	Brand	Applicazione/Application	Rif. Orig./Orig. Ref.	Immagine/Image
91459	Sinistro//Left	CASE	JX55, JX60, JX65, JX70, JX75, JX80, JX85, JX90, JX95	87620234	
91462	Destro//Left		JX-U100, JX-U1070, JX-U1080, JX-U1090, JX-U1100, JX-U70, JX-U80, JX-U90,, MXM120, MXM130, MXM140, MXM155, MXM175, MXM190	82019225, 82036000	
91463	Sinistro//Left		JX-U100, JX-U1070, JX-U1080, JX-U1090, JX-U1100, JX-U70, JX-U80, JX-U90,, MXM120, MXM130, MXM140, MXM155, MXM175, MXM190	82019226, 82036001	
91483	Destro//Right		JX55, JX60, JX65, JX70, JX75,, JX80, JX85, JX90, JX95	87620223	

Art./Ref.	Note/Notes	Brand	Applicazione/Application	Rif. Orig./Orig. Ref.	Immagine/Image
91490	Destro//Right	CASE	MAXXUM 100, MAXXUM 110,, MAXXUM 115, MAXXUM 125,, MAXXUM 140, MXU 100, MXU 110,, MXU 115, MXU 125, MXU 135	82027356, 87528172, 87560791	
91491	Sinistro//Left		MAXXUM 100, MAXXUM 110,, MAXXUM 115, MAXXUM 120,, MAXXUM 125, MAXXUM 130,, MAXXUM 140, MXU 100, MXU 110,, MXU 115, MXU 125, MXU 130,, MXU 135, PUMA 115, PUMA 125, PUMA 140, PUMA 155, PUMA 160,, PUMA 165, PUMA 170, PUMA 180,, PUMA 185, PUMA 195, PUMA 200,, PUMA 210, PUMA 215, PUMA 230	82027357, 87528171, 87530786, 87560786	
91538	Destro//Right		JX1060, JX1070, JX1075, QUANTUM 65, QUANTUM 75,, QUANTUM 85, QUANTUM 95,	44910452	
91539	Sinistro//Left		JX1060, JX1070, JX1075, QUANTUM 65, QUANTUM 75,, QUANTUM 85, QUANTUM 95,	44910453	
91545	Destro//Right		CS130, CS150, CS78, CS80, CS85, CS86, CS90,, CS94, CS105, CS110, CS120,, CVX1155, CVX1170, CVX1190, CVX120, CVX130, CVX150, CVX170, CVX195, CVX1135, CVX1145,	134621081, 134621091, 47110845	
91546	Sinistro//Left		CS130, CS150, CS78, CS80, CS85, CS86, CS90,, CS94, CS105, CS110, CS120,, CVX1155, CVX1170, CVX1190, CVX120, CVX130, CVX150, CVX170, CVX195, CVX1135, CVX1145,	134621001, 134621080, 134621090, 47110844	
91495	Destro - Sinistro/ Right - Left	DEUTZ	AGROSUN 100, AGROSUN 120,, AGROSUN 140	0.9234.212.0/20	

Art./Ref.	Note/Notes	Brand	Applicazione/Application	Rif. Orig./Orig. Ref.	Immagine/Image
91502	Destro//Right	DEUTZ	AGROTON NEW 90, AGROTON NEW100, AGROTON NEW105, AGROTON NEW108, AGROTON NEW110, AGROTON NEW118, AGROTON NEW120, AGROTON NEW128, AGROTRON 4.70, AGROTRON 4.80,, AGROTRON 4.85, AGROTRON 4.90,, AGROTRON 4.95, AGROTRON 6.00,, AGROTRON 6.01, AGROTRON 6.05,, AGROTRON 6.15, AGROTRON 6.20,, AGROTRON 6.30, AGROTRON 6.45,, AGROTRON MK3 100, AGROTRON MK3 105, AGROTRON MK3 106, AGROTRON MK3 110, AGROTRON MK3 115, AGROTRON MK3 120, AGROTRON MK3 135, AGROTRON MK3 150, AGROTRON MK3 160, AGROTRON MK3 175, AGROTRON MK3 200, AGROTRON MK3 230, AGROTRON MK3 260, AGROTRON MK3 80, AGROTRON MK3 85, AGROTRON MK3 90, M600, M610, AGROTRON NEW 80,	04418952	
91503	Sinistro//Left		AGROTON NEW 90, AGROTON NEW100, AGROTON NEW105, AGROTON NEW108, AGROTON NEW110, AGROTON NEW118, AGROTON NEW120, AGROTON NEW128, AGROTRON 4.70, AGROTRON 4.80,, AGROTRON 4.85, AGROTRON 4.90,, AGROTRON 4.95, AGROTRON 6.00,, AGROTRON 6.01, AGROTRON 6.05,, AGROTRON 6.15, AGROTRON 6.20,, AGROTRON 6.30, AGROTRON 6.45,, AGROTRON MK3 100, AGROTRON MK3 105, AGROTRON MK3 106, AGROTRON MK3 110, AGROTRON MK3 115, AGROTRON MK3 120, AGROTRON MK3 135, AGROTRON MK3 150, AGROTRON MK3 160, AGROTRON MK3 175, AGROTRON MK3 200, AGROTRON MK3 230, AGROTRON MK3 260, AGROTRON MK3 80, AGROTRON MK3 85, AGROTRON MK3 90, M600, M610, AGROTRON NEW 80,	04418951	
91516	Destro//Right		AGROTRON K110, AGROTRON K120, AGROTRON K410 COM3, AGROTRON K420 COM3, AGROTRON K420 PROFILINE COM3, AGROTRON K430 COM3, AGROTRON K430 PROFILINE COM3, AGROTRON K610 COM3, AGROTRON K610 PROFILINE COM3, AGROTRON K90, AGROTRON K100		
91517	Sinistro//Left		AGROTRON K110, AGROTRON K120, AGROTRON K410 COM3, AGROTRON K420 COM3, AGROTRON K420 PROFILINE COM3, AGROTRON K430 COM3, AGROTRON K430 PROFILINE COM3, AGROTRON K610 COM3, AGROTRON K610 PROFILINE COM3, AGROTRON K90, AGROTRON K100	0.012.1433.0/20	

Art./Ref.	Note/Notes	Brand	Applicazione/Application	Rif. Orig./Orig. Ref.	Immagine/Image
26505	Sinistro//Left	FIAT	140.90 DT, 180.90 DT, ATTACHMENTS TS23-24-25-28	5130883	
26506	Destro//Right		140.90 DT, 180.90 DT, ATTACHMENTS TS23-24-25-28	5130884	
26510	Sinistro//Left		55.88-55.88 DT, 60.88-60.88 DT, 65.88-65.88 DT, 70.88-70.88 DT, 80.88-80.88 DT, ATTACHMENTS TS23-24-25-28	5124414	

Art./Ref.	Note/Notes	Brand	Applicazione/Application	Rif. Orig./Orig. Ref.	Immagine/Image
26511	Destro//Right	FIAT	55.88-55.88 DT, 60.88-60.88 DT, 65.88-65.88 DT, 70.88-70.88 DT, 80.88-80.88 DT, ATTACHMENTS TS23-24-25-28	5125038	
91456	Sinistro//Left		140-90, 160-90, 180-90, 70-88, 80-88, 70-90, 80-90,, 90-90, 100-90, 115-90, 130-90,	5117682	
91457	Destro//Right		140-90, 160-90, 180-90, 70-88, 80-88, 70-90, 80-90,, 90-90, 100-90, 115-90, 130-90,	5117683	
91518	Destro - Sinistro/ Right - Left		WINNER 100F, WINNER 110F, WINNER 115F, WINNER 120F, WINNER 130F, WINNER 140F	5154934	
91522	Destro//Right		55-88, 60-88, 65-88, 70-88,, 80-88, 55-90, 60-90, 70-90,, 80-90, CS580, CS680, CS780,, CS880, CS980	5108670	
91523	Sinistro//Left		55-88, 60-88, 65-88, 70-88,, 80-88, 55-90, 60-90, 70-90,, 80-90, CS580, CS680, CS780,, CS880, CS980	5108669	
26505	Sinistro//Left		FORD	8430, 8630, 8830	5130883
26506	Destro//Right	8430, 8630, 8830		5130884	



Art./Ref.	Note/Notes	Brand	Applicazione/Application	Rif. Orig./Orig. Ref.	Immagine/Image
91460	Sinistro//Left	FORD	5640, 6640, 7740, 7840, 8160,, 8240, 8260, 8340, 8360, 8560	82000396	
91461	Destro//Right		8160, 8260, 8360, 8560	82000367	
91495	Destro - Sinistro/ Right - Left	HURLIMANN	SIAC H496, SIAC H5116,, SIAC H6136, SIAC H6170	0.9234.212.0/20	
91516	Destro//Right		XM120, XM125, XM90, XM100, XM110, XM115,	0.012.1439.0/10	
91517	Sinistro//Left		XM120, XM125, XM90, XM100, XM110, XM115,	0.012.1433.0/20	
91459	Sinistro//Left	NEW HOLLAND	TD55, TD60, TD65, TD70, TD75, TD80, TD85, TD90, TD95	87620234	
91483	Destro//Right		TD55, TD60, TD65, TD70, TD75, TD80, TD85, TD90, TD95	87620223	

Art./Ref.	Note/Notes	Brand	Applicazione/Application	Rif. Orig./Orig. Ref.	Immagine/Image
91460	Sinistro//Left	<b>NEW HOLLAND</b>	G170, G190, G210, G240, M100, M115, M135, M160, TL80, TL90, TL100, TS90, TS100, TS110, TS115	82000396	
91461	Destro//Right		M100, M115, M135, M160, TL80, TL90, TL100, TS90, TS100, TS110, TS115	82000367	
91462	Destro//Left		T5030, T5040, T5050, T5060, T5070, TL80, TL90, TL100, TLA70A, TL80A, TL90A, TL100A, TM115, TM120, TM125, TM130,, TM135, TM140, TM150, TM155, TM165, TM175, TM190, TS90, TS100, TS110, TS115	82019225, 82036000	
91463	Sinistro//Left		T5030, T5040, T5050, T5060, T5070, TL80, TL90, TL100, TLA70A, TL80A, TL90A, TL100A, TM115, TM120, TM125, TM130,, TM135, TM140, TM150, TM155, TM165, TM175, TM190, TS90, TS100, TS110, TS115	82019226, 82036001	
91490	Destro//Right		T6.155, T6.120, T6.140, T6.150, T6.160, T6.165, T6.175, T7.170, T6010, T6020, T6030, T6040,, T6050, T6060, T6070, T6080, T6090, T70, T7.185, T7.200, T7.210, T7.220, T7.235, T7.250, T7.260, T7.270	82027356, 87528172, 87560791	
91491	Sinistro//Left		T6.155, T6.120, T6.140, T6.150, T6.160, T6.165, T6.175, T7.170, T7.185, T7.200, T7.210, T7.220	82027357, 87528171, 87530786, 87560786	
91538	Destro//Right		T4020, T4030, T4040, T4050, TN55, TN60, TN70, TN75, TN85, TN95	44910452	

Art./Ref.	Note/Notes	Brand	Applicazione/Application	Rif. Orig./Orig. Ref.	Immagine/Image
91539	Sinistro//Left		T4020, T4030, T4040, T4050, TN55, TN60, TN70, TN75, TN85, TN95	44910453	
91545	Destro//Right		T7520, T7530, T7540, T7550, TVT135, TVT145, TVT155, TVT170, TVT190, TVT195	134621081, 134621091, 47110845	
91546	Sinistro//Left		T7520, T7530, T7540, T7550, TVT135, TVT145, TVT155, TVT170, TVT190, TVT195	134621001, 134621080, 134621090, 47110844	
91464	Destro - Sinistro// Right - Left	LAMBORGHINI	GRAND PRIX 674-70, GRAND PRIX 874-90	0.9231.212.0	
91495	Destro - Sinistro// Right - Left		GALAXY 170, LASER 130, LASER 150, LASER160, LASER 90, LASER 100, LASER 110, R1306, R1306 TURBO, LASER 85, SLH 956-100, R956, R1106,	0.9234.212.0/20	
91516	Destro//Right		R6 100, R6 110, R6 115, R6 120, R6 125	0.012.1439.0/10	
91517	Sinistro//Left		R6 100, R6 110, R6 115, R6 120, R6 125	0.012.1433.0/20	

Art./Ref.	Note/Notes	Brand	Applicazione/Application	Rif. Orig./Orig. Ref.	Immagine/Image
<b>91464</b>	Destro - Sinistro/ Right - Left	<b>SAME</b>	ANTARES 100, EXPLORER 40, EXPLORER 50,, EXPLORER 55, EXPLORER 60,, EXPLORER 70, EXPLORER 75,, EXPLORER 80, EXPLORER 90, EXPLORER 95, EXPLORER 100	0.9231.212.0	
<b>91516</b>	Destro//Right		IRON 100, IRON 110, IRON 115, IRON 120		
<b>91517</b>	Sinistro//Left		IRON 100, IRON 110, IRON 115, IRON 120	0.012.1433.0/20	
<b>91713</b>	Sinistro//Left		DORADO F100, DORADO F70,, FRUTTETO II 55, FRUTTETO, FRUTTEO II 100,	0.009.8820.0/10	
<b>91714</b>	Destro//Right		DORADO F100, DORADO F70,, FRUTTETO II 55, FRUTTETO, FRUTTEO II 100,	0.009.8821.0/10	
<b>91716</b>	Sinistro//Left		DORADO F100, DORADO F70,, FRUTTETO II 55, FRUTTETO, FRUTTEO II 100,	0.009.8820.0	
<b>91717</b>	Destro//Right		DORADO F100, DORADO F70,, FRUTTETO II 55, FRUTTETO, FRUTTEO II 100,	0.009.8821.0	

Art./Ref.	Note/Notes	Brand	Applicazione/Application	Rif. Orig./Orig. Ref.	Immagine/Image
91538	Destro//Right	STEYR	KOMPAKT 360, KOMPAKT 370, KOMPAKT 375, KOMPAKT 485, KOMPAKT 4075, KOMPAKT 4085, KOMPAKT 4095, KOMPAKT 495, KOMPAKT 4065	44910452	
91539	Sinistro//Left		KOMPAKT 360, KOMPAKT 370, KOMPAKT 375, KOMPAKT 485, KOMPAKT 4075, KOMPAKT 4085, KOMPAKT 4095, KOMPAKT 495, KOMPAKT 4065	44910453	
91545	Destro//Right		M9078, M9080, M9083, M9086,, M9090, M9094, M9100, M9105,, M9115, M9125	134621081, 134621091, 47110845	
91546	Sinistro//Left		M9078, M9080, M9083, M9086,, M9090, M9094, M9100, M9105,, M9115, M9125	134621001, 134621080, 134621090, 47110844	

**CRISTALLO PORTA INFERIORE ADATTABILE**

VITRE PORTE BAS ADAPTABLE  
 LOWER DOOR GLASS SUITABLE  
 ERSATZGLAS PASSEND ZU  
 VIDRIO PUERTA COMPATIBLE

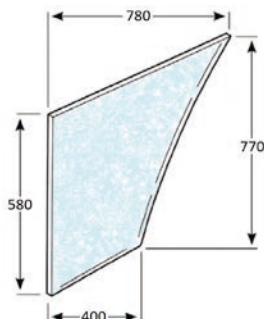

Art./Ref.	Brand	Applicazione/Application	Rif. Orig./Orig. Ref.
59758	FORD	4635, 4835, 5635, 6635, 7635	82002181
59758	NEW HOLLAND	L60, L65, L75, L85, L95	82002181

**CRISTALLO LATERALE ADATTABILE**

VITRE LATERAL ADAPTABLE  
 SIDE GLASS SUITABLE  
 SEITLICHES PASSEND ZU  
 VENTANILLA LATERAL COMPATIBLE

Art./Ref.	Brand	Applicazione/Application	Rif. Orig./Orig. Ref.	Immagine/Image
26504	FIAT	55.88-55.88 DT, 60.88-60.88 DT, 65.88.65.88 DT, 70.88-70.88 DT, 80.88.80.88 DT, ATTACHMENTS TS23-24-25-28	5124412	
N044911555		-	44911555	-
59764	SAME LAMBORGHINI HURLIMANN	ANTARES I 100, EXPLORER 55-65-75, EXPLORER 90TURBO - II 90 TURBO, HURLIMAN 356-358, HURLIMAN 446-468-476-478-488, LAMBORGH 674.70-774.80-874.90	0.9231.214.0	
59767	SAME LAMBORGHINI HURLIMANN	GALAXY 100-110-130-150-90, HURLIMAN 496-5116-6136-6170, LAMBORGHINI 1106-1306-956, LASER 100-110-130-150-90	0.9234.214.0/20	

**CRISTALLI POSTERIORI ADATTABILI**

VITRE ARRIERE ADAPTABLE  
 REAR GLASS SUITABLE  
 HECKSCHEIBE OBEN PASSED ZU  
 CRISTAL POSTERIOR COMPATIBLE

Art./Ref.	Brand	Applicazione/Application	Rif. Orig./Orig. Ref.	Immagine/Image
91540	CASE	JX-C 1060, JX-C 1070,, JX-C 1075, JX-C 1085,, JX-C 1095, QUANTUM 65, QUANTUM 75,, QUANTUM 85, QUANTUM 95	44911502	
91543		CS130, CS150, CS78, CS80, CS85, CS86, CS90,, CS94, CS105, CS110, CS120,, CVX1155, CVX1170, CVX1190, CVX120, CVX130, CVX150, CVX170, CVX195, CVX1135, CVX1145,	134671049, 134671061, 134671062, 134671072, 134671091, 134671092, 47110842	

Art./Ref.	Brand	Applicazione/Application	Rif. Orig./Orig. Ref.	Immagine/Image
91496	DEUTZ	AGROSUN 100, AGROSUN 120,, AGROSUN 140	0.9234.273.0	
91497		AGROSUN 100, AGROSUN 120, AGROSUN 140	0.9234.215.0/20	
91509		AGROTON NEW 90, AGROTON NEW100, AGROTON NEW105, AGROTON NEW108, AGROTON NEW110, AGROTON NEW118, AGROTON NEW120, AGROTON NEW128, AGROTRON 4.70, AGROTRON 4.80,, AGROTRON 4.85, AGROTRON 4.90,, AGROTRON 4.95, AGROTRON 6.00,, AGROTRON 6.01, AGROTRON 6.05,, AGROTRON 6.15, AGROTRON 6.20,, AGROTRON 6.30, AGROTRON 6.45,, AGROTRON MK3 100, AGROTRON MK3 105, AGROTRON MK3 106, AGROTRON MK3 110, AGROTRON MK3 115, AGROTRON MK3 120, AGROTRON MK3 135, AGROTRON MK3 150, AGROTRON MK3 160, AGROTRON MK3 175, AGROTRON MK3 200, AGROTRON MK3 230, AGROTRON MK3 260, AGROTRON MK3 80, AGROTRON MK3 85, AGROTRON MK3 90, M600, M610, AGROTRON NEW 80,	04418956	
91514		AGROTRON K110, AGROTRON K120, AGROTRON K410 COM3,, AGROTRON K420 COM3,, AGROTRON K420 PROFILINE COM3, AGROTRON K430 COM3,, AGROTRON K430 PROFILINE COM3, AGROTRON K610 COM3,, AGROTRON K610 PROFILINE COM3, AGROTRON K90, AGROTRON K100	0.012.1438.0/30	
91515		AGROTRON K110, AGROTRON K120, AGROTRON K410 COM3,, AGROTRON K420 COM3,, AGROTRON K420 PROFILINE COM3, AGROTRON K430 COM3,, AGROTRON K430 PROFILINE COM3, AGROTRON K610 COM3,, AGROTRON K610 PROFILINE COM3, AGROTRON K90, AGROTRON K100	0.012.1439.0/10	
91533		ANTARES 100, EXPLORER 100, EXPLORER 40, EXPLORER 50,, EXPLORER 60, EXPLORER 70, EXPLORER 75, EXPLORER 80,, EXPLORER 90, EXPLORER 95	0.9231.215.0	
26502	FIAT	140.90 DT, 180.90 DT, ATTACHMENTS TS23-24-25-28	5130388	
26501	FORD	4635, 4835, 5635, 5640, 6635, 6640, 66400, 7635, 7740, 77400, 7840, 8160, 8240, 8260, 8340, 8360, 8560	5178304, 82005316	

Art./Ref.	Brand	Applicazione/Application	Rif. Orig./Orig. Ref.	Immagine/Image
26502	FORD	8430, 8630, 8830	5130388	
91496	HURLIMANN	SIAC H496, SIAC H5116,, SIAC H6136, SIAC H6170	0.9234.273.0	
91497		SIAC H496, SIAC H5116,, SIAC H6136, SIAC H6170	0.9234.215.0/20	
91514		XM120, XM125, XM90, XM100, XM110, XM115,	0.012.1438.0/30	
91515		XM120, XM125, XM90, XM100, XM110, XM115,	0.012.1439.0/10	
91533		H-356, H-358, H-466, H-468,, H-476, H-478, H-488	0.9231.215.0	
91465	LAMBORGHINI	GRAND PRIX 674-70,, GRAND PRIX 874-90	0.9231.268.0/10	
91496		GALAXY 170, LASER 130, LASER 150, LASER160, LASER 90, LASER 100, LASER 110, R1306, R1306 TURBO, LASER 85, SLH 956-100, R956, R1106,	0.9234.273.0	



Art./Ref.	Brand	Applicazione/Application	Rif. Orig./Orig. Ref.	Immagine/Image
91514	LAMBORGHINI	R6 100, R6 110, R6 115, R6 120, R6 125	0.012.1438.0/30	
91515		R6 100, R6 110, R6 115, R6 120, R6 125	0.012.1439.0/10	
91533		GRAND PRIX 674-70,, GRAND PRIX 874-90	0.9231.215.0	
26501	NEW HOLLAND	L60, L65, L75, L85, L95, LOADERS 90 FL, M115, M135, M160, T5030, T5040, T5050, T5060, T5070, TL100, TL100A, TL55F, TL65, TL65A, TL65F, TL70, TL70A, TL75F, TL80, TL80A, TL90, TL90A, TM110, TM120, TM130, TM140, TM7010, TM7020, TM7030, TM7040, TS100, TS110, TS115, TS120, TS125, TS6000, TS6020, TS6030, TS6040, TS80, TS90	82016997	
91465	SAME	ANTARES 100, EXPLORER 40, EXPLORER 50,, EXPLORER 55, EXPLORER 60, EXPLORER 70, EXPLORER 75,, EXPLORER 80, EXPLORER 90,, EXPLORER 95, EXPLORER 100	0.9231.268.0/10	
91497		GALAXY 170, LASER 110, LASER 130,, LASER 130, LASER 150, LASER 85, LASER 90, LASER 100	0.9234.215.0/20	
91514		IRON 100, IRON 110, IRON 115, IRON 120	0.012.1438.0/30	
91515		IRON 100, IRON 110, IRON 115, IRON 120	0.012.1439.0/10	

Art./Ref.	Brand	Applicazione/Application	Rif. Orig./Orig. Ref.	Immagine/Image
91533	SAME	ANTARES 100, EXPLORER 100, EXPLORER 40, EXPLORER 50,, EXPLORER 60, EXPLORER 70,, EXPLORER 75, EXPLORER 80,, EXPLORER 90, EXPLORER 95,	0.9231.215.0	
91715		DORADO F100, DORADO F70,, FRUTTETO II 55, FRUTTETO, FRUTTEO II 100,	0.009.8626.0/10	
91718		DORADO F100, DORADO F70,, FRUTTETO II 55, FRUTTETO, FRUTTEO II 100,	0.009.8626.0	

**CRISTALLO POSTERIORE SUPERIORE ADATTABILE**
*VITRE ARRIERE ADAPTABLE*
*UPPER REAR GLASS SUITABLE*
*HECKSCHEIBE OBEN PASSEND ZU*
*CRISTAL DE PORTON COMPATIBLE FIAT*

91458	CASE	JX55, JX60, JX65, JX70, JX75, JX80, JX85, JX90, JX95	5089562	
91492		MAXXUM 110, MAXXUM 115,, MAXXUM 125, MAXXUM 140,, MXU 100, MXU 110, MXU 115,, MXU 125, MAXXUM 100,, PUMA 100, PUMA 110, PUMA 115,, PUMA 125, PUMA 140, PUMA 165,, PUMA 180, PUMA 195, PUMA 210	82014988, 82030887, 87663400, 87744542	
91504	DEUTZ	AGROTON NEW 90, AGROTON NEW100, AGROTON NEW105, AGROTON NEW108, AGROTON NEW110, AGROTON NEW118, AGROTON NEW120, AGROTON NEW128, AGROTRON 4.70, AGROTRON 4.80,, AGROTRON 4.85, AGROTRON 4.90,, AGROTRON 4.95, AGROTRON 6.00,, AGROTRON 6.01, AGROTRON 6.05,, AGROTRON 6.15, AGROTRON 6.20,, AGROTRON 6.30, AGROTRON 6.45,, AGROTRON MK3 100, AGROTRON MK3 105, AGROTRON MK3 106, AGROTRON MK3 110, AGROTRON MK3 115, AGROTRON MK3 120, AGROTRON MK3 135, AGROTRON MK3 150, AGROTRON MK3 160, AGROTRON MK3 175, AGROTRON MK3 200, AGROTRON MK3 230, AGROTRON MK3 260, AGROTRON MK3 80, AGROTRON MK3 85, AGROTRON MK3 90, M600, M610, AGROTRON NEW 80,	04419379	

Art./Ref.	Brand	Applicazione/Application	Rif. Orig./Orig. Ref.	Immagine/Image
91505	DEUTZ	AGROTON NEW 90, AGROTON NEW100, AGROTON NEW105, AGROTON NEW108, AGROTON NEW110, AGROTON NEW118, AGROTON NEW120, AGROTON NEW128, AGROTRON 4.70, AGROTRON 4.80,, AGROTRON 4.85, AGROTRON 4.90,, AGROTRON 4.95, AGROTRON 6.00,, AGROTRON 6.01, AGROTRON 6.05,, AGROTRON 6.15, AGROTRON 6.20,, AGROTRON 6.30, AGROTRON 6.45,, AGROTRON MK3 100, AGROTRON MK3 105, AGROTRON MK3 106, AGROTRON MK3 110, AGROTRON MK3 115, AGROTRON MK3 120, AGROTRON MK3 135, AGROTRON MK3 150, AGROTRON MK3 160, AGROTRON MK3 175, AGROTRON MK3 200, AGROTRON MK3 230, AGROTRON MK3 260, AGROTRON MK3 80, AGROTRON MK3 85, AGROTRON MK3 90, M600, M610, AGROTRON NEW 80,	04429137	
26509	FIAT	55.88-55.88 DT, 60.88-60.88 DT, 65.88-65.88 DT, 70.88-70.88 DT, 80.88-80.88 DT, ATTACHMENTS TS23-24-25-28	5124413	
61558		100.90 - 100.90 DT, 115.90 - 115.90 DT, 140.90 - 140.90 DT, 70.90 - 70.90DT, CABINE CS17, CABINE CS19, CABINE CS21	5129357	
91466		45.665, 50.665, 56.665	5136410	
91519		WINNER 100F, WINNER 110F, WINNER 115F, WINNER 120F, WINNER 130F, WINNER 140F	5154756	
91521		G170, G190, G210, G240	86002901	
91458	NEW HOLLAND	TD55, TD60, TD65, TD70, TD75, TD80, TD85, TD90, TD95	5089562	
91492		T6.120, T6.140, T6.150, T6.155, T6.160, T6.165, T6.17, T6010, T6020, T6030, T6040, T6050,, T6060, T6070, T6080, T6090,, T7030, T7040, T7060, TSA1	82014988, 82030887, 87663400, 87744542	

**CRISTALLO POSTERIORE INFERIORE ADATTABILE**

GLACE ARRIER ADAPTABLE

LOWER REAR GLASS SUITABLE

ERSATZGLAS HINTEN PASSEND ZU

CRISTAL TRASERO/POSTERIOR COMPATIBLE



Art./Ref.	Brand	Applicazione/Application	Rif. Orig./Orig. Ref.	Immagine/Image
91472	CASE	MXM120, MXM130, MXM140, MXM155, MXM175, MXM190	82000485	
91544		CS130, CS150, CS78, CS80, CS85, CS86, CS90,, CS94, CS105, CS110, CS120,, CVX1155, CVX1170, CVX1190, CVX120, CVX130, CVX150, CVX170, CVX195, CVX1135, CVX1145,	134671086, 47110486	
91498	DEUTZ	AGROSUN 100, AGROSUN 120,, AGROSUN 140	0.9234.216.0/20	
91507		AGROTON NEW 90, AGROTON NEW100, AGROTON NEW105, AGROTON NEW108, AGROTON NEW110, AGROTON NEW118, AGROTON NEW120, AGROTON NEW128, AGROTRON 4.70, AGROTRON 4.80,, AGROTRON 4.85, AGROTRON 4.90,, AGROTRON 4.95, AGROTRON 6.00,, AGROTRON 6.01, AGROTRON 6.05,, AGROTRON 6.15, AGROTRON 6.20,, AGROTRON 6.30, AGROTRON 6.45,, AGROTRON MK3 100, AGROTRON MK3 105, AGROTRON MK3 106, AGROTRON MK3 110, AGROTRON MK3 115, AGROTRON MK3 120, AGROTRON MK3 135, AGROTRON MK3 150, AGROTRON MK3 160, AGROTRON MK3 175, AGROTRON MK3 200, AGROTRON MK3 230, AGROTRON MK3 260, AGROTRON MK3 80, AGROTRON MK3 85, AGROTRON MK3 90, M600, M610, AGROTRON NEW 80,	0.010.5210.0/20	
91508		AGROTON NEW 90, AGROTON NEW100, AGROTON NEW105, AGROTON NEW108, AGROTON NEW110, AGROTON NEW118, AGROTON NEW120, AGROTON NEW128, AGROTRON 4.70, AGROTRON 4.80,, AGROTRON 4.85, AGROTRON 4.90,, AGROTRON 4.95, AGROTRON 6.00,, AGROTRON 6.01, AGROTRON 6.05,, AGROTRON 6.15, AGROTRON 6.20,, AGROTRON 6.30, AGROTRON 6.45,, AGROTRON MK3 100, AGROTRON MK3 105, AGROTRON MK3 106, AGROTRON MK3 110, AGROTRON MK3 115, AGROTRON MK3 120, AGROTRON MK3 135, AGROTRON MK3 150, AGROTRON MK3 160, AGROTRON MK3 175, AGROTRON MK3 200, AGROTRON MK3 230, AGROTRON MK3 260, AGROTRON MK3 80, AGROTRON MK3 85, AGROTRON MK3 90, M600, M610, AGROTRON NEW 80,	04414216	
91534		AGROTRAC 100, AGROTRAC 110, AGROTRAC 130, AGROTRAC 150, AGROTRAC 610, AGROTRAC 620	0.007.7337.0/10, 0.075.106.0/20, 0.075.181.0/20	
91535		AGROTRAC 100, AGROTRAC 110, AGROTRAC 130, AGROTRAC 150, AGROTRAC 610, AGROTRAC 620	0.075.312.0/20	
91472	FIAT	L60, L65, L75, L85, L95, M100, M115, M135, M160	82000485	

Art./Ref.	Brand	Applicazione/Application	Rif. Orig./Orig. Ref.	Immagine/Image
91520	FIAT	WINNER 100F, WINNER 110F, WINNER 115F, WINNER 120F, WINNER 130F, WINNER 140F	5153550	
91472	FORD	4635, 4835, 5635, 6635, 7635,, 8160, 8260, 8360, 8560	82000485	
91498		SIAC H496, SIAC H5116,, SIAC H6136, SIAC H6170	0.9234.216.0/20	
91534	HURLIMANN	ELITE H-6115, XT-85, XT-95,, ELITE H-6135, XT-140, XT-160, XT-105, XT-110, XT-115, XT-130, XT-908, XT-909, XT901.4,, XT-910.6, XT-911, XT-913	0.007.7337.0/10, 0.075.106.0/20, 0.075.181.0/20	
91535		ELITE H-6115, XT-85, XT-95,, ELITE H-6135, XT-140, XT-160, XT-105, XT-110, XT-115, XT-130, XT-908, XT-909, XT901.4,, XT-910.6, XT-911, XT-913	0.075.312.0/20	
91498	LAMBORGHINI	GALAXY 170, LASER 130, LASER 150, LASER160, LASER 90, LASER 100, LASER 110, R1306, R1306 TURBO, LASER 85, SLH 956-100, R956, R1106,	0.9234.216.0/20	
91472	NEW HOLLAND	TL70, TL80, TL90, TL100, TM115, TM120, TM125, TM130, TM135,, TM140, TM150, TM155, TM165,, TM175, TM190	82000485	
91544		T7520, T7530, T7540, T7550, TVT135, TVT145, TVT155, TVT170, TVT190, TVT195	134671086, 47110486	
59765	SAME LAMBORGHINI HURLIMANN	ANTARES I 100, EXPLORER 55-60-65-70-75-80, EXPLORER 90TURBO - II 90 TURBO, HURLIMAN 356-358, HURLIMAN 446-468-476-478-488, LAMBORGH 674.70-774.80-874.90	0.9231.255.0	
91544	STEYR	M9078, M9080, M9083, M9086,, M9090, M9094, M9100, M9105,, M9115, M9125	134671086, 47110486	

**TEROSON PU 8597 HMLC- ADESIVO MONOCOMPONENTE PER L'INCOLLAGGIO DEI CRISTALLI**
*TEROSON PU 8597 HMLC- COLLAGE VITRAGE*
*TEROSON PU 8597 HMLC- DIRECT GLAZING*
*TEROSON PU 8597 HMLC- KLEBEN UND DICHTEN VON AUTOGLAS*
*TEROSON PU 8597 HMLC- ADHESIVO SELLADOR MONOCOMPONENTE*

**Note:** Teroson 8597 HMLC è un sigillante monocomponente a base poliuretana per la sostituzione dei vetri auto, estremamente pastoso e reagisce con l'umidità dando luogo ad un materiale gommoso ed elastico. Il tempo di formazione della pelle ed il tempo di reticolazione dipendono dall'umidità, dalla temperatura; in più, la cura totale, dalla profondità del giunto. Un incremento della temperatura e dell'umidità possono accelerare la formazione della pelle e la reticolazione mentre un abbassamento della temperatura e dell'umidità possono ritardare il processo. Teroson PU 8519 P è un primer / attivatore molto fluido a base di poliuretano contenente solventi. Il prodotto si distingue per il suo buon potere coprente e la sua eccellente stabilità agli UV; non contiene idrocarburi clorurati o aromatici. Teroson PU 8519 P è inoltre indicato per la protezione dalla corrosione per piccoli danni alla vernice. Teroson PU 8519 P è indispensabile come promotore di adesione di Teroson PU 8597 HMLC al vetro e come attivatore per il vecchio sigillante.

**Notes:** Teroson 8597 HMLC is a 1-component, extremely sag-resistant direct glazing adhesive / sealant based on polyurethane, which crosslinks (cures) to a rubber-elastic material under the influence of atmospheric moisture. The skin formation time and the curing time depend on the moisture of the air and the temperature; in addition, the curing time depends on the depth of the joint. An increase in temperature and atmospheric humidity can accelerate skin formation and curing, whereas a lower content of atmospheric humidity and lower temperatures delay the reaction. Teroson PU 8519 P is a primer / activator very fluid based polyurethane containing solvents. The product stands out for its good covering power and excellent UV stability; it doesn't contain chlorinated or aromatic hydrocarbons. Teroson PU 8519 P is also suitable for the protection of the corrosion damage to the small vernice. Teroson PU 8519 P is indispensable as an adhesion promoter of Teroson 8597 HMLC

Art./Ref.	Colore/Color	Capacità ml/MI capacity	Confezionamento/ Packaging	Base/Base	Temperatura/ Temperature	Tempo/Time	Resistenza prod.chimici/ Resistance to chemical prod.	Immagine/Image
89019	NERO/BLACK	310	CARTUCCIA	Poliuretano	DA -40°C A +90°C	25 MIN	ALTA	
89020					da -40°C a +90°C	2 min		

**LOCTITE® SF 7040 ADDITIVO LAVAPARABREZZA -40**
*LOCTITE® SF 7040 ADDITIF NETTOYANT LAVAGE*
*LOCTITE® SF 7040 WASHING-CLEANER ADDITIVE*
*LOCTITE® SF 7040 WASCH-REINIGER-ADDITIV*
*LOCTITE® SF 7040 ADITIVO LIMPIADOR DE LAVADO*

**NOTE:** Detergente anticongelante per impianto lavavetro fino a -40°C. Ottimo anche nel periodo estivo per rimuovere moscerini ed altri insetti.

Non sporca e non aggredisce i componenti in gomma o plastica.

**NOTES:** Anti-freeze detergent for washer system up to -40 °C.

Also excellent during the summer to remove midges and other insects.

Do not dirty or attack rubber or plastic components

Art./Ref.	Capacità Lt/Lt capacity
91317	5 Litri

**LOCTITE® DEGHIACCIANTE PARABREZZA SUPER FAST**

LOCTITE® SUPER FAST ANTI SPRAY ANTI-GLACE  
 LOCTITE® SUPER FAST WINDSCREENING SPRAY  
 LOCTITE® SUPER FAST ANTI ICE WINDSCHUTZ SPRAY  
 LOCTITE® SUPER FAST SPRAY ANTI HIELO PARABRISAS



**NOTE:** Deghiacciante liquido, scioglie istantaneamente e senza fatica il ghiaccio formatosi su qualsiasi superficie, in particolare su vetri, specchi d'auto, moto e camion. non è necessario raschiare, non lascia aloni e non danneggia l'auto.

**NOTES:** No frost liquid, instantly and effortlessly melts the ice formed on any surface, especially on glass, car mirrors, motorcycles and trucks. it is not necessary to scrape, it does not leave marks and it does not damage the car.

Art./Ref.	Capacità ml/MI capacity
91318	500 ml

**GUARNIZIONI PER VETRI IN P.V.C.**

JOINTS EN PVC POUR VERRE  
 PVC GLASS GASKETS  
 PVC-DICHTUNGEN  
 JUNTAS DE PVC

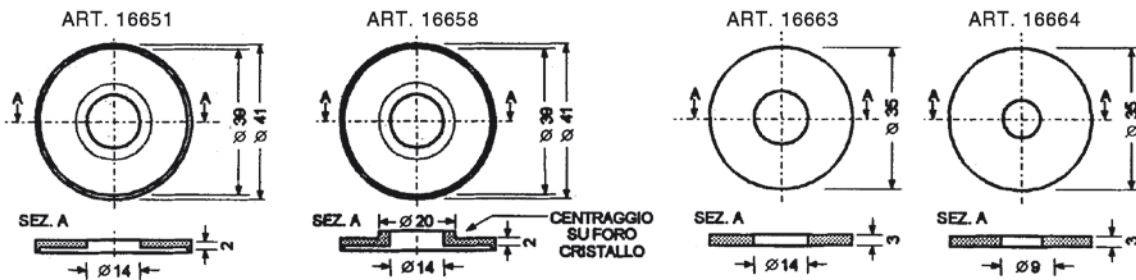

Art./Ref.	Note/Notes
16651	Ø esterno 41mm, Ø foro 14mm/Outer Ø 41mm, hole Ø 14mm
16658	Ø esterno 41mm, Ø foro 14mm. Ø 20mm centraggio su foro cristallo./Outer Ø 41mm, hole Ø 14mm, glass hole Ø 20mm
16663	Ø esterno 35mm, Ø foro 14mm/Outer Ø 35mm, hole Ø 9mm
16664	Ø esterno 35mm, Ø foro 9mm/Outer Ø 35mm, hole Ø 9mm

**GUARNIZIONI PER VETRI**

SEALS DE VITRAGE  
GLASS SEALS  
DICHTUNGEN FÜR GLASER  
JUNTAS DE VIDRIOS

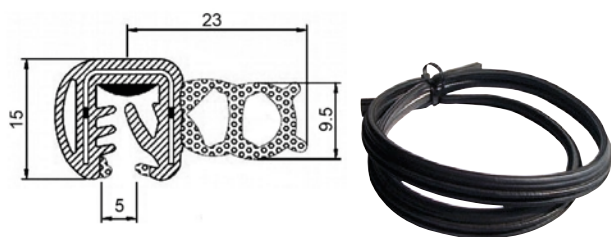

Art./Ref.	Note/Notes
<b>57811</b>	ROTOLO DA 5 MT/5-METER ROLL
<b>75767</b>	ROTOLO DA 20 MT/20 METERS

**GUARNIZIONI PER PORTELLONI POSTERIORI PER CAVI ELETTRICI**

CAOUTCHOUCS PROFILES POUR LUNETTE ARRIERE  
REAR DOOR GLASS RUBBER FOR ELECTRIC CABLES  
DICHTUNG FÜR DIE HECKSCHEIBE  
SELLOS DE VIDRIO TRASERO PARA CABLES ELÉCTRICOS

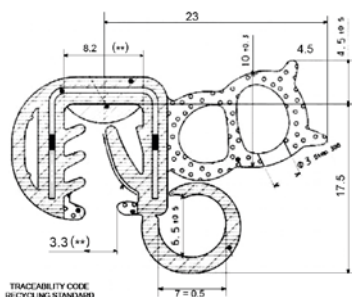

TRACEABILITY CODE  
RECYCLING STANDARD  
DATE/TIME/COUNTRY

Art./Ref.	Note/Notes
<b>89036</b>	ROTOLO DA 5 MT/5-METER ROLL
<b>89037</b>	ROTOLO DA 20 MT/20 METERS

**GUARNIZIONI COPRILAMIERA FINO A 2,5MM**

JOINTS COUVRENT FEUILLE JUSQU'A 2,5MM  
METAL SHEET SEAL UP TO 2,5MM  
DICHTUNGEN DECKBLATT BIS ZU 2,5MM  
SELLOS CUBREN LA HOJA HASTA 2,5MM

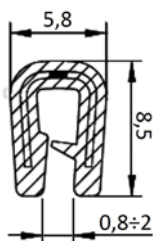

Art./Ref.	Note/Notes
<b>89050</b>	ROTOLO DA 5 MT/5-METER ROLL
<b>89051</b>	ROTOLO DA 20 MT/20 -METER ROLL

**GUARNIZIONI COPRILAMIERA FINO A 4MM**

JOINTS COUVRENT FEUILLE JUSQU'A 4MM  
METAL SHEET SEAL UP TO 4MM  
DICHTUNGEN DECKBLATT BIS ZU 4MM  
SELLOS CUBREN LA HOJA HASTA 4MM

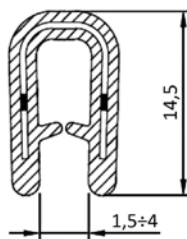

Art./Ref.	Note/Notes
<b>89048</b>	ROTOLO DA 5 MT/5-METER ROLL
<b>89049</b>	ROTOLO DA 20 MT/20 METERS

**GUARNIZIONI PER LAMIERA O ABS E COFANI CON AGGANCIO FINO A 3 MM**

SEALS POUR LES METAUX OU ABS ET DES CERCUEILS AVEC RACCORDEMENT AU 3MM  
SEALS FOR METAL OR ABS AND BONNETS WITH HOOKING UP TO 3MM  
SEALS FÜR ROHR ABS UND SARGE MIT EINHAKEN BIS ZU 3MM  
JUNTAS DE METAL O DE ABS Y ATAQUES CON CONEXIÓN A 3MM

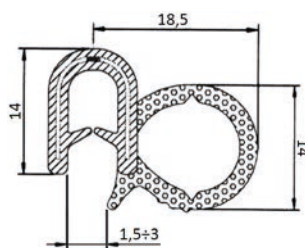

Art./Ref.	Note/Notes
<b>89044</b>	ROTOLO DA 5 MT/5-METER ROLL
<b>89045</b>	ROTOLO DA 20 MT/20 METERS

**GUARNIZIONI PER CABINE E PER LAMIERA**

SEALS POUR CABINE ET DE L'ACIER  
SEALS FOR CABS AND METAL SHEETS  
DICHTUNGEN KABINE UND STAHL  
SELLOS DE CABINA Y ACERO

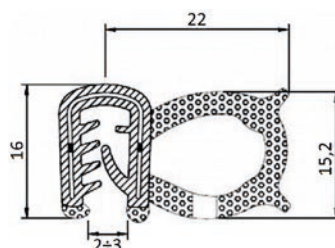

Art./Ref.	Note/Notes
<b>89042</b>	ROTOLO DA 5 MT/5-METER ROLL
<b>89043</b>	ROTOLO DA 20 MT/20 METERS



**GUARNIZIONI PER LAMIERA O ABS CON AGGANCO DA 1MM A 3MM**

SEALS POUR LES METAUX OU ABS AVEC RACCORDEMENT DE 1MM AU 3MM  
 SEALS FOR METAL OR ABS WITH HOOKING FROM 1MM TO 3MM  
 SEALS FÜR ROHR ABS MIT EINHAKEN DE 1MM ZU 3MM  
 JUNTAS DE METAL O DE ABS CON CONEXIÓN DA 1MM A 3MM

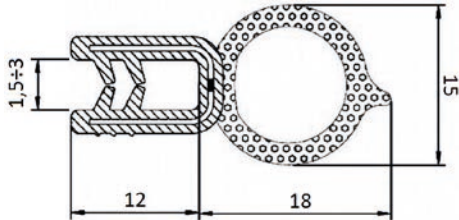

Art./Ref.	Note/Notes
89040	ROTOLO DA 5 MT/5-METER ROLL
89041	ROTOLO DA 20 MT/20-METER ROLL

**GUARNIZIONE PER LAMIERA O ABS CON AGGANCO DA 3 MM A 5 MM**

SEALS POUR LES METAUX OU ABS AVEC RACCORDEMENT DE 3MM AU 5MM  
 SEALS FOR METAL OR ABS WITH HOOKING FROM 3MM TO 5MM  
 SEALS FÜR ROHR ABS MIT EINHAKEN DE 3MM ZU 5MM  
 JUNTAS DE METAL O DE ABS CON CONEXIÓN DA 3MM A 5MM

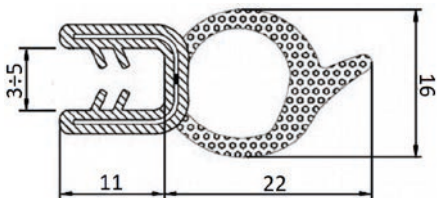

Art./Ref.	Note/Notes
89038	ROTOLO DA 5 MT/5-METER ROLL
89039	ROTOLO DA 20 MT/20-METER ROLL

**MANIGLIA ESTERNA AD INCASSO UNIVERSALE PER TRATTORI**

POIGNEE EXTERIEURE A ANCAISSEMENT UNIVERSELLW POUR TRACTEUR  
 UNIVERSAL OUTSIDE HANDLE FOR TRACTORS  
 UNIVERSALEINBAUGRIFF FUER TRAKTOREN  
 MANILLA ESTERNA DE ENCAJE UNIVERSAL PARA TRACTORES

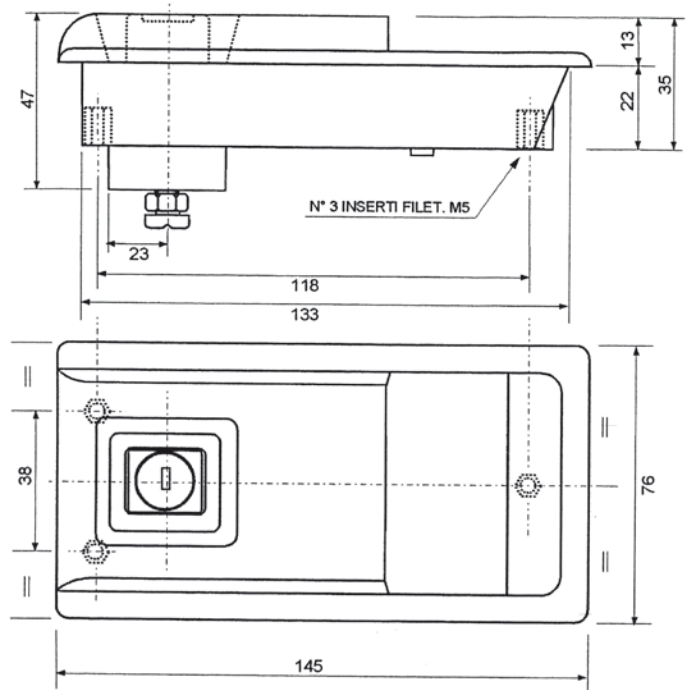

Art./Ref.	Note/Notes
37032	Dx e Sx/Rh and Lh

**MANIGLIA PER CABINE TRATTORI**

POIGNEE POUR CABINES TRACTEUR  
HANDLE FOR TRACTOR CAB  
GRIFF FÜR TRAKTORKABINEN  
MANILLA POR CABINAS TRACTORES

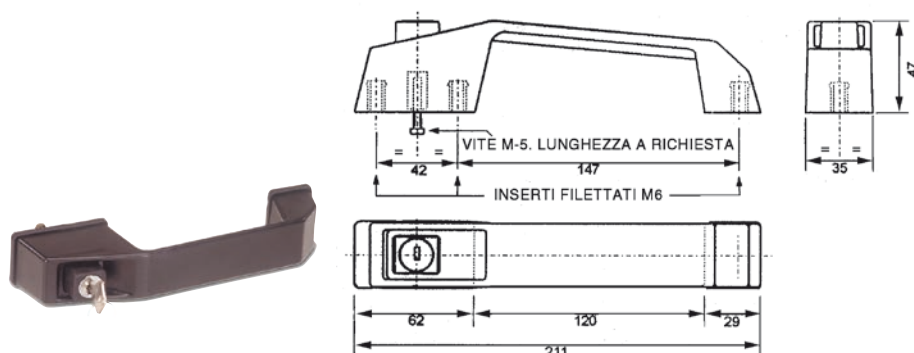

Art./Ref.	Note/Notes	Colore/Color	Brand	Ricambio/Replacement
<b>16628</b>	Materiale corpo maniglia: <b>plastica</b> / Handle body material: <b>Plastic</b>	Nero/Black	<b>A.M.A.</b>	<b>16635</b> - SERRATURA UNIVERSALE CABINE CON COPERTURA IN PLASTICA NERA DX / RIGHT LOCK FOR TRACTORS WITH BLACK PLASTIC COVER <b>16636</b> - SERRATURA UNIVERSALE CABINE CON COPERTURA IN PLASTICA NERA SX / UNIVERSAL LEFT DOOR LOCK FOR TRACTORS WITH BLACK PLASTIC COVER, <b>16637</b> - SERRATURA UNIVERSALE CABINE CON COPERTURA IN PLASTICA NERA DX / UNIVERSAL DOOR LOCK FOR TRACTORS WITH BLACK PLASTIC COVER, RIGHT, <b>16638</b> - SERRATURA UNIVERSALE CABINE CON COPERTURA IN PLASTICA NERA SX / UNIVERSAL DOOR LOCK FOR TRACTORS WITH BLACK PLASTIC COVER, LEFT, <b>16643</b> - SERRATURA UNIVERSALE CABINE TRATTORI DX / RH UNIVERSAL TRACTOR DOOR LOCK , <b>16644</b> - SERRATURA UNIVERSALE CABINE TRATTORI SX / LH UNIVERSAL TRACTOR DOOR LOCK

**MANIGLIA PER CABINE TRATTORI**

POIGNEE POUR CABINES TRACTEUR  
HANDLE FOR TRACTOR CAB  
GRIFF FÜR TRAKTORKABINEN  
MANILLA POR CABINAS TRACTORES

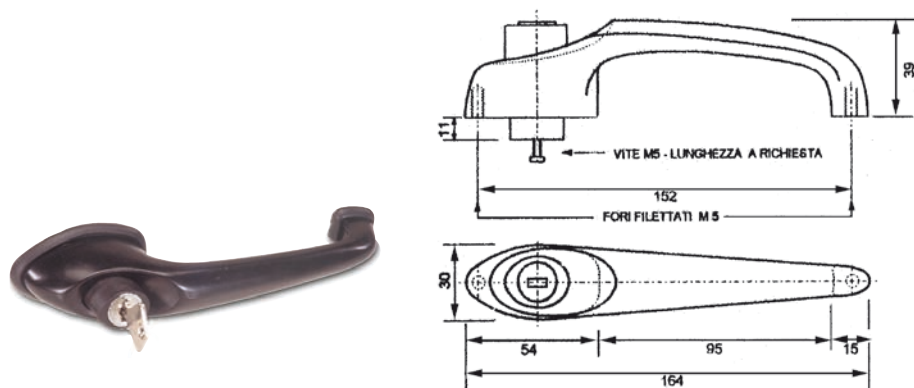

Art./Ref.	Note/Notes	Colore/Color	Brand	Ricambio/Replacement
<b>16632</b>	Materiale corpo maniglia <b>Zama</b> / Handle body material <b>Zama</b>	Nero/Black	<b>A.M.A.</b>	<b>16635</b> - SERRATURA UNIVERSALE CABINE CON COPERTURA IN PLASTICA NERA DX / RIGHT LOCK FOR TRACTORS WITH BLACK PLASTIC COVER, <b>16636</b> - SERRATURA UNIVERSALE CABINE CON COPERTURA IN PLASTICA NERA SX / UNIVERSAL LEFT DOOR LOCK FOR TRACTORS WITH BLACK PLASTIC COVER, <b>16637</b> - SERRATURA UNIVERSALE CABINE CON COPERTURA IN PLASTICA NERA DX / UNIVERSAL DOOR LOCK FOR TRACTORS WITH BLACK PLASTIC COVER, RIGHT, <b>16638</b> - SERRATURA UNIVERSALE CABINE CON COPERTURA IN PLASTICA NERA SX / UNIVERSAL DOOR LOCK FOR TRACTORS WITH BLACK PLASTIC COVER, LEFT, <b>16643</b> - SERRATURA UNIVERSALE CABINE TRATTORI DX / RH UNIVERSAL TRACTOR DOOR LOCK , <b>16644</b> - SERRATURA UNIVERSALE CABINE TRATTORI SX / LH UNIVERSAL TRACTOR DOOR LOCK

**MANIGLIA PER CABINE TRATTORI**

POIGNEE PUOR CABINES TRACTEUR  
HANDLE FOR TRACTOR CAB  
GRIFF FUR TRAKTORKABINEN  
MANILLA POR CABINAS TRACTORES



**Note:** Completa di guarnizioni e doppia chiave. Maniglia: Poliammide - Pulsante: poliammide - Guarnizione: TSP.  
**Notes:** With gaskets and double key. Handle: polyamide - Push button: polyamide - Gasket: TSP

Art./Ref.	Tipo/Type
91941	Sinistra//Left
91942	Destra //Right

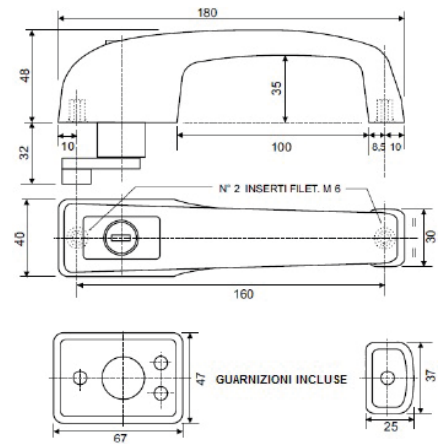

**MANIGLIE UNIVERSALI PER PORTE ESTERNE DI CABINE TRATTORI**

POIGNEE UNIVERSELLES POUR PORTES EXTERIEURES DU CABINES TRACTEURS  
UNIVERSAL HANDLE FOR EXTERNAL TRACTORS CAB DOORS  
UNIVERSALGRIFF FUR KABINEN-AUSSENTUEREN  
MANILLAS UNIVERSALES PARA PUERTAS DE CABINAS DE TRACTORES

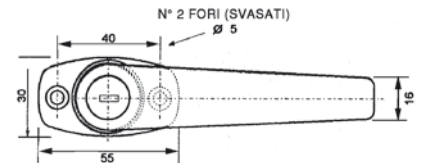
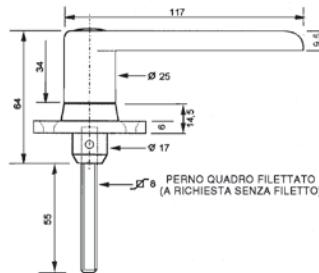

Art./Ref.	Note/Notes	Colore/Color
16631	Materiale corpo maniglia: <b>Zama</b> /Handle body material: <b>Zama</b>	Nero/Black

**SERRATURE PER MANIGLIA ART AMA 16631**

FERMETURE POUR REF. AMA 16631  
DOOR LOCK FOR AMA REF. 16631  
VERSCHLUSS FUR ART. 16631  
CERRADURAS PARA ART. 16631

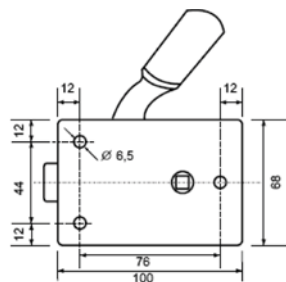

Art./Ref.	Note/Notes	Brand	Applicazione/Application
34011	Dx/Rh/	A.M.A.	16631
34012	Sx/Lh		16631

**SERRATURE UNIVERSALI SEMPLICI/REGISTRABILI PER CABINE TRATTORI**

SERRURES UNIVERSELLES SIMPLES/REGLABLES POUR CABINES TRACTEURS  
SIMPLE/ADJUSTABLE UNIVERSAL LOCKS FOR TRACTOR CABS  
UNIVERSALVERSCHLUSS EINFACH/EINSTELLBAR FUER KABINEN  
CERRADURA UNIVERSAL SIMPLE/REGISTRABLE PARA CABINAS DE TRACTORES

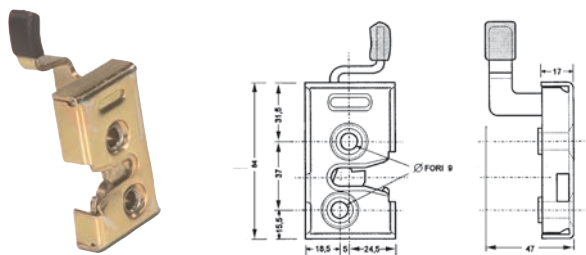

**Note:** In acciaio zincato  
**Notes:** Galvanized steel

Art./Ref.	Note/Notes	Brand	Applicazione/Application
16643	DX/RH	A.M.A.	16628
16644	SX/LH	A.M.A.	16632

**SERRATURE UNIVERSALI SEMPLICI/REGISTRABILI PER CABINE TRATTORI**

SERRURES UNIVERSELLES SIMPLES/REGLABLES POUR CABINES TRACTEURS  
SIMPLE/ADJUSTABLE UNIVERSAL LOCKS FOR TRACTOR CABS  
UNIVERSALVERSCHLUSS EINFACH/EINSTELLBAR FUER KABINEN  
CERRADURA UNIVERSAL SIMPLE/REGISTRABLE PARA CABINAS DE TRACTORES

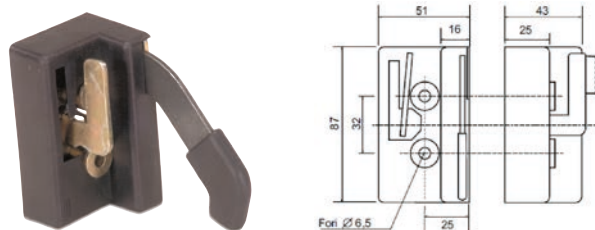

**Note:** Con copertura in plastica nera e leva piegata  
**Notes:** With plastic black cover and bent lever.

Art./Ref.	Note/Notes	Brand	Applicazione/Application
16637	DX/RH	A.M.A.	16628
16638	SX/LH	A.M.A.	16632

**SERRATURE UNIVERSALI SEMPLICI/REGISTRABILI PER CABINE TRATTORI**

SERRURES UNIVERSELLES SIMPLES/REGLABLES POUR CABINES TRACTEURS  
SIMPLE/ADJUSTABLE UNIVERSAL LOCKS FOR TRACTOR CABS  
UNIVERSALVERSCHLUSS EINFACH/EINSTELLBAR FUER KABINEN  
CERRADURA UNIVERSAL SIMPLE/REGISTRABLE PARA CABINAS DE TRACTORES

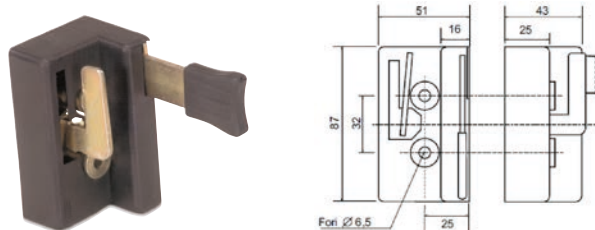

**Note:** Con copertura in plastica nera e leva dritta  
**Notes:** With plastic black cover and straight lever.

Art./Ref.	Note/Notes	Brand	Applicazione/Application
16635	Dx/Rh	A.M.A.	16628
16636	SX/LH		16632

**SERRATURE UNIVERSALI SEMPLICI PER CABINE TRATTORI**

SERRURES UNIVERSELLES SIMPLES POUR CABINES TRACTEURS  
SIMPLE UNIVERSAL LOCK FOR TRACTOR CABS  
UNIVERSALVERSCHLUSS EINFACH FUER KABINEN  
CERRADURA UNIVERSAL SIMPLE PARA CABINAS DE TRACTORES

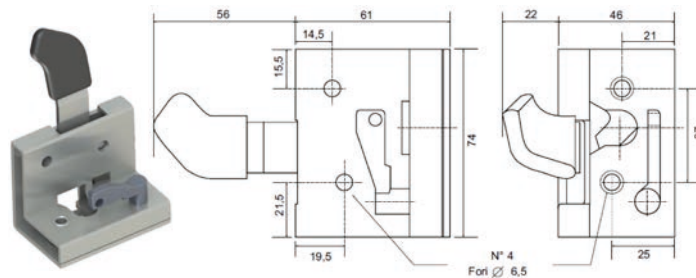

**Note:** Struttura: acciaio zincato - Settori: carbonitrurati e zincati - Pomello: gomma termoplastica  
**Notes:** Structure: galvanized steel - Sectors: carbonitrided and galvanized - Knob: thermoplastic rubber

Art./Ref.	Tipo/Type
91939	Destra //Right
91940	Sinistra//Left

**KIT MANIGLIA PER CABINE TRATTORI**

KIT POIGNEE POUR CABINES TRACTEUR  
HANDLE KIT FOR TRACTOR CAB  
KIT GRIFF FÜR TRAKTORKABINEN  
KIT MANILLA POR CABINAS TRACTORES

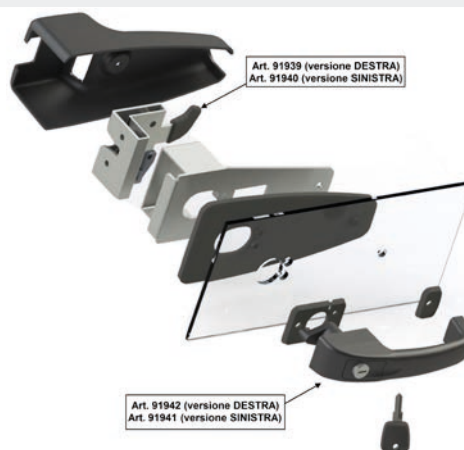

**Note:** Kit completo di chiave, formato dai codici ama 91939 e 91942  
**Notes:** Kit with key. Formed with ama code 91939 and 91942

Art./Ref.	Tipo/Type
91943	Destra //Right
91944	Sinistra//Left

**SCONTO PER SERRATURA SEMPLICE**

GACHE POUR SERRURE SIMPLE  
RABBET FOR SIMPLE LOCK  
SCHRAUBE FUER VERSCHLUSS EINFACH  
BISAGRA DE CERRADURA SIMPLE



Art./Ref.	Note/Notes
16640	M12x1.5

**PROTEZIONE PER SCANTRO**

PROTECTION POUR GACHE  
RABBET PROTECTION  
SCHUTZ  
PROTECCIÓN PARA BISAGRA



Art./Ref.
16642

**DADO DI FISSAGGIO SCANTRO**

ECROU FIXAGE GACHE  
RABBET FIXING NUT  
BEFESTIGUNGSMUTTER  
TUERCA DE FISAJE PARA BISAGRA

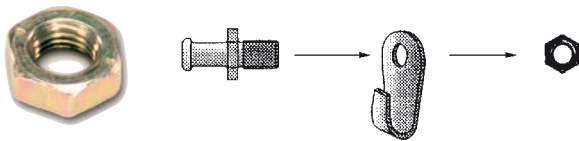

Art./Ref.
16641

**RISCONTRO PER SERRATURA REGISTRABILE**

GACHE SERRURES REGLABLES  
RABBET FOR ADJUSTABLE LOCK  
SCHRAUBE FUER VERSCHLUSS EINSTELLBAR  
BISAGRA DE CERRADURA REGISTRABLE

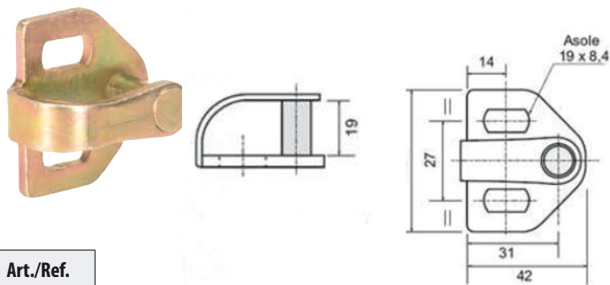

Art./Ref.
16639

**SERRATURA UNIVERSALE PER CABINE TRATTORI**

POIGNEE UNIVERSELLE POUR CABINES TRACTEURS  
UNIVERSAL LOCKS FOR TRACTOR CABINS  
UNIVERSALVERSCHLUSS FUER KABINEN  
CERRADURA UNIVERSAL PARA CABINAS TRACTORES

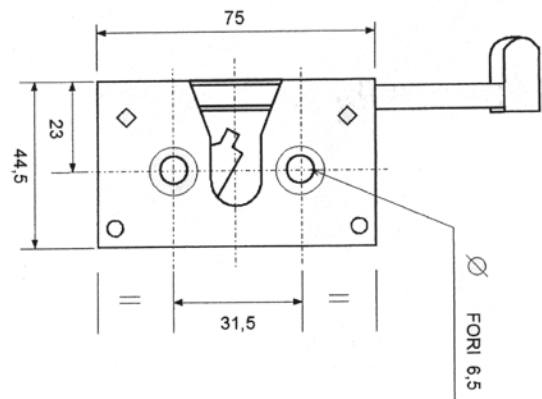

Art./Ref.	Note/Notes
37033	Dx/Rh
37034	Sx/Lh

**SERRATURE A BARRA PER CABINE TRATTORI**

FERMETURE LONGUE POUR CABINES TRACTEURS  
BAR LATCHES TRACTOR CABINS  
VERSCHLUSS FUER KABINEN  
CERRADURA CON BRAZO UNIVERSAL PARA CABINAS TRACTORES

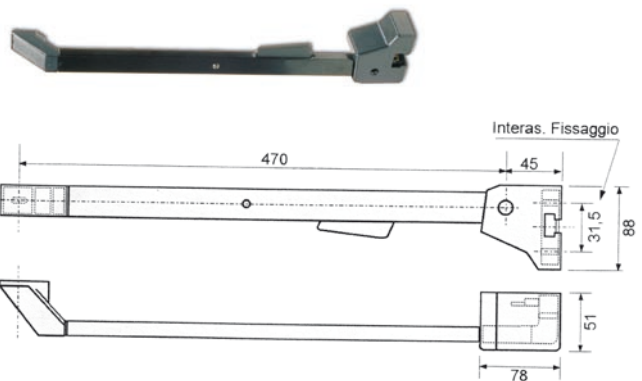

Art./Ref.	Note/Notes
37035	Dx/Rh
37036	Sx/Lh

**PIASTRA DI FISSAGGIO SERRATURA**

PLAQUE DE FIXATION POIGNEE  
FIXING PLATE FOR LOCKS  
VERSCHLUSSBEFESTIGUNGSPLATTE  
PLANCHA DE FIJACIÓN CERRADURA

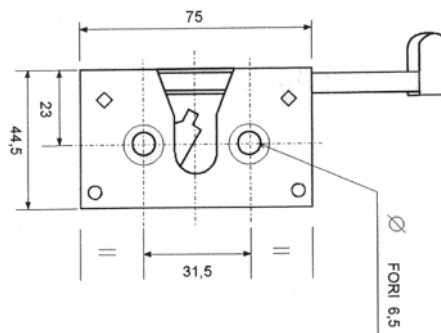

Art./Ref.	Note/Notes	Brand	Applicazione/Application
<b>37037</b>	Dx e Sx/Rh and Lh	<b>A.M.A.</b>	37033, 37034, 37035, 37036

**MANIGLIE E SERRATURE PER CABINE ADATTABILI FIAT**

POIGRÉES ET FERMETURE POUR CABINES ADAPTABLE FIAT  
CABINE HANDLES SUITABLE FIAT  
KABINENGRIFFE PASSEND ZU FIAT  
MANILLAS Y CERRADURAS PARA CABINAS COMPATIBLE FIAT



Art./Ref.	Descrizione/Description	Brand	Applicazione/Application	Rif. Orig./Orig. Ref.
<b>15842</b>	Serratura sinistra/Left lock	<b>FIAT</b>	140.90DT, 160.90DT, 180.90DT, 55.88, 55.88/DT, 60.88, 60.88/DT, 65.88, 65.88/DT, 70.88, 70.88/DT, 80.88, 80.88/DT, ATTACHMENTS TS23-24-25-28	5108380, 5132340
<b>15843</b>	Serratura destra/Right lock		140.90DT, 160.90DT, 180.90DT, 55.88, 55.88/DT, 60.88, 60.88/DT, 65.88, 65.88/DT, 70.88, 70.88/DT, 80.88, 80.88/DT, ATTACHMENTS TS23-24-25-28	5108381, 5132339
<b>15844</b>	Maniglia destra/Right handle		140.90DT, 160.90DT, 180.90DT, 55.88, 55.88/DT, 60.88, 60.88/DT, 65.88, 65.88/DT, 70.88, 70.88/DT, 80.88, 80.88/DT, ATTACHMENTS TS23-24-25-28	5108392
<b>15845</b>	Maniglia sinistra/Left handle		140.90DT, 160.90DT, 180.90DT, 55.88, 55.88/DT, 60.88, 60.88DT, 65/88, 65/88DT, 70.88, 70.88DT, 80.88, 80.88DT, ATTACHMENTS TS23-24-25-28	5108382
<b>15842</b>	Serratura sinistra/Left lock	<b>FORD</b>	8430, 8630, 8830	5108380
<b>15843</b>	Serratura destra/Right lock		8430, 8630, 8830	5108381
<b>15844</b>	Maniglia destra/Right handle		8430, 8630, 8830	5108392
<b>15845</b>	Maniglia sinistra/Left handle		8430, 8630, 8830	5108382

**MANIGLIA INTERNA DI APPIGLIO**

POIGNEE INTERIEURE PRISE  
GRAB INSIDE HANDLE  
INNERER HALTEGRIFFF  
MANILLA INTERNA

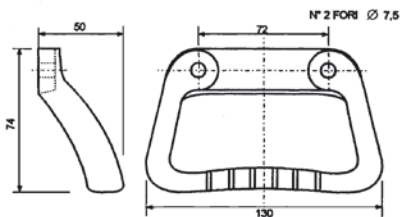

Art./Ref.
<b>16686</b>

**MANIGLIA INTERNA DI APPIGLIO/TIRAPORTA**

POIGNEE INTERIEURE PRISE TIRE-PORTE  
 GRAB HANDLE  
 INNERER HALTEGRIFF ZUM TUERSCHLIESSEN  
 MANILLA INTERNA/TIRAPUERTAS

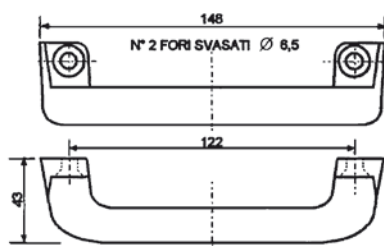

Art./Ref.
16687

**MANIGLIA INTERNA DI APPIGLIO/TIRAPORTA**

POIGNEE INTERIEURE PRISE TIRE-PORTE  
 GRAB INSIDE HANDLE  
 INNERER HALTEGRIFF ZUM TUERSCHLIESSEN  
 MANILLA INTERNA/TIRAPUERTAS

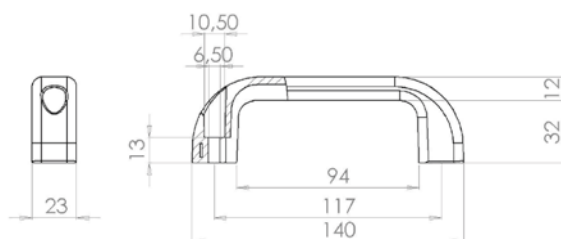

Art./Ref.
91946

**GANCIO APPENDIABILI**

CROCHET POUR ROBES  
 CLOTHES HOOK  
 HAKEN FÜR KLEIDER  
 GANCHO PARA VESTIDOS

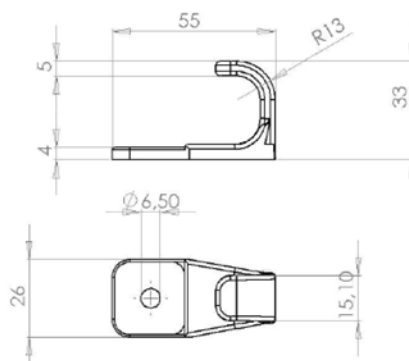

Art./Ref.
91947

**KIT MANIGLIA DI APERTURA A SCATTO PER FINESTRINO**

KIT POIGNEE OUVERTURE FENETRE A DOIGHT  
 SNAP-OPENING HANDLE KIT  
 SATZ GRIFF ZUR FENSTEROEFFNUNG  
 MANILLA DE APERTURA PARA VENTANILLA

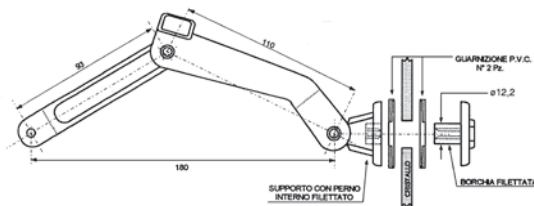

Art./Ref.
16684

**KIT MANIGLIA APERTURA FINESTRINO A SCATTO CON SGANCIO DI EMERGENZA**

KIT POIGNEE OUVERTURE FENETRE A DOIGHT AVEC DECROCHAGE D'EMERGENCE  
 SNAP-OPENING HANDLE KIT WITH EMERGENCY REALISING  
 SATZ GRIFF ZUR FENSTEROEFFNUNG MIT AUSLOESEVORRICHTUNG  
 MANILLA DE APERTURA CON DESENGANCHE DE EMERGENCIA PARA VENTANILLA



Art./Ref.
16685

**MANIGLIA CHIUSURA FINESTRINO UNIVERSALE**

POIGNEE FERMETURE FENETRE UNIVERSELLE  
 UNIVERSAL WINDSCREEN CLOSURE HANDLE  
 GRIFF FENSTERVERSCHLUSS UNIVERSAL  
 MANILLAS DE CIERRE DE VENTANILLA UNIVERSAL



**Note:** Con vite M6x30  
**Notes:** With screw M6x30

Art./Ref.	Note/Notes
16646	Destro/Right
16647	Sinistro/Left

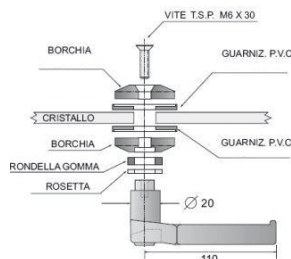
**MANIGLIA CHIUSURA FINESTRINO UNIVERSALE**

POIGNEE FERMETURE FENETRE UNIVERSELLE  
 UNIVERSAL WINDSCREEN CLOSURE HANDLE  
 GRIFF FENSTERVERSCHLUSS UNIVERSAL  
 MANILLAS DE CIERRE DE VENTANILLA UNIVERSAL

**Note:** Con vite M8x35. Con aggancio  
**Notes:** With screw M8x35. With hook

Art./Ref.	Note/Notes
16653	Destro/Right
16654	Sinistro/Left

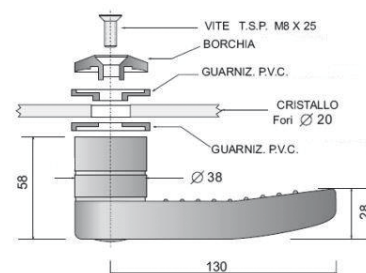



**MANIGLIA CHIUSURA FINESTRINO UNIVERSALE**

POIGNEE FERMETURE FENETRE UNIVERSELLE  
 UNIVERSAL WINDSCREEN CLOSURE HANDLE  
 GRIFF FENSTERVERSCHLUSS UNIVERSAL  
 MANILLAS DE CIERRE DE VENTANILLA UNIVERSAL

**Note:** Con flangia di fissaggio in acciaio zincato a due fori  
**Notes:** With galvanized steel fixing plate two holes.

Art./Ref.	Note/Notes
16648	Destro/Right
16649	Sinistro/Left

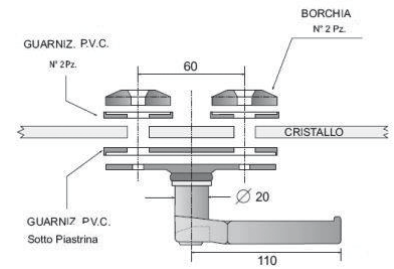

**MANIGLIA CHIUSURA FINESTRINO UNIVERSALE**

POIGNEE FERMETURE FENETRE UNIVERSELLE  
 UNIVERSAL WINDSCREEN CLOSURE HANDLE  
 GRIFF FENSTERVERSCHLUSS UNIVERSAL  
 MANILLAS DE CIERRE DE VENTANILLA UNIVERSAL

**Note:** Con flangia di fissaggio in plastica a due fori  
**Notes:** With plastic fixing plate 2 holes

Art./Ref.	Note/Notes
16655	Destro/Right
16656	Sinistro/Left

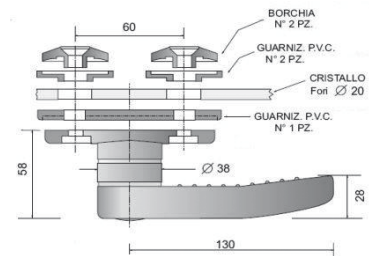

**RISCONTRO PER CHIUSURE FINESTRINO**

GACHE POUR FERMETURE FENETRE  
 RABBET FOR WINDOW CLOSURES  
 PLATTE FENSTERVERSCHLUSS  
 BISAGRA PARA CIERRE DE VENTANILLA

Art./Ref.
16660

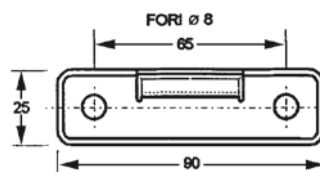

**SUPPORTO DI FISSAGGIO PER MANIGLIE FINESTRINO**

FIXING SUPPORT FOR WINDOW SNAP CLOSURE HANDLE  
 SUPPORT DE FIXATION POUR POIGNÉE DE FERMETURE DE FENÊTRE  
 BEFESTIGUNGSHALTER FÜR FENSTER VERSCHLUSSGRIFF  
 SOPORTE DE MONTAJE PARA MANILLA DE BLOQUEO DE VENTANILLA

**Note:** Materiale: acciaio verniciato a polvere nero  
**Notes:** Material: black powder coated steel

Art./Ref.
91987

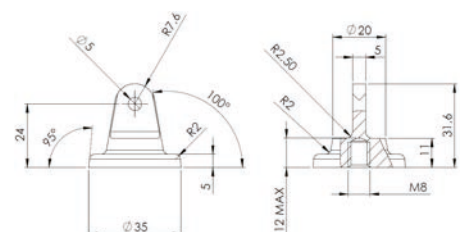

**PORTA BOTTIGLIA/THERMOS**

PORTE BOUTEILLE  
BOTTLE OR FLASK HOLDER  
FLASCHENHALTER  
PORTABOTELLAS

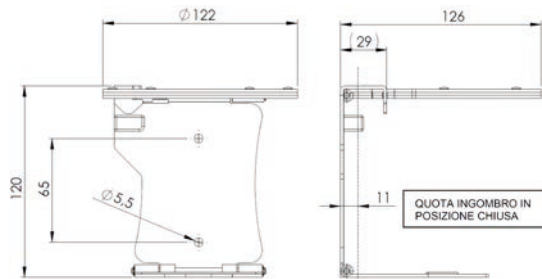

**Note:** Struttura in acciaio verniciato nero, apribile e richiudibile.

Possibilità di utilizzo con bottiglie, borracce, thermos da Ø 60mm a Ø 90mm.

**Notes:** Black powder coated steel. Open support ring for bottle or thermos with measures from Ø 60mm to Ø 90mm.

Art./Ref.
<b>91945</b>

**VERNICI ADATTABILI MACCHINE AGRICOLE**

LAQUES ADAPTABLE MACHINES AGRICOLES  
PAINTS ADAPTABLE AGRICULTURAL MACHINES  
LACKE PASSEND ZU LANDMACHINEN  
BARNICES ADAPTABLE MAQUINARIA AGRICOLAS



LEGENDA COLORI	
ARANCIO	GRIGIO METALLIZZATO
ARANCIO SCURO	MARRONE
AZZURRO	PANNA
BLU	ROSSO
GIALLO	TERRACOTTA
GRIGIO	TESTA DI MORO
GRIGIO ANTRACITE	VERDE

**Note:** Latta da 1lt

**Notes:** 1lt tin

Art./Ref.	Note/Notes	Colore/Color	Brand	Rif. Orig./Orig. Ref.
<b>04442</b>	Carrozzeria/Body	Blu/Bleu	<b>BCS</b>	
<b>88960</b>	Carrozzeria//Body	Rosso/Red	<b>CARRARO ANTONIO</b>	.
<b>88961</b>	Carrozzeria//Body	Grigio/Grey		.
<b>88701</b>	Carrozzeria//Body	Giallo/Yellow	<b>CATERPILLAR</b>	.
<b>88962</b>	Carrozzeria//Body	Verde/Green/	<b>CLAAS</b>	.
<b>88963</b>	Carrozzeria//Body	Grigio/Grey		.
<b>89032</b>	Carrozzeria//Body	Verde/Green	<b>FENDT</b>	.
<b>89033</b>	Carrozzeria//Body	Rosso/Red		.
<b>89031</b>	Carrozzeria//Body	Grigio/Grey		.
<b>04444</b>	Carrozzeria vecchi modelli/Old models body	Arancio/Orange	<b>FIAT</b>	9973437
<b>04446</b>	Carrozzeria vecchi modelli/Old models body	Terracotta/Hellbraun		9973458
<b>04448</b>	Telaio e motore/Chassis and engine	Testa di moro/Brown		9973523
<b>42071</b>	Carrozzeria//Body	Grigio metallizzato/Metalic grey		
<b>88700</b>	Carrozzeria//Body	Blu/Blue	<b>FIAT - NEW HOLLAND</b>	9973459, 9973459
<b>12255</b>	Carrozzeria//Body	Blu/Blue	<b>FORD</b>	9973439
<b>12257</b>	Telaio e cerchi ruota//Body and wheel rims	Grigio/Gray		9973416
<b>42071</b>	Carrozzeria//Body	Grigio metallizzato/Metalic grey		9973497

Art./Ref.	Note/Notes	Colore/Color	Brand	Rif. Orig./Orig. Ref.
88694	Carrozzeria//Body	Arancio/Orange	GOLDONI	.
88695	Carrozzeria//Body	Verde/Green		.
88699	Carrozzeria//Body	Verde/Green	HURLIMANN	.
14997	Carrozzeria//Body	Verde/Green	JOHN DEERE	.
15000	Carrozzeria//Body	Giallo/Yellow		.
91161	Carrozzeria//Body	Verde//Green	CELLI	
91886	Carrozzeria//Body	Giallo//Yellow	CHALLENGER	
91884	Carrozzeria//Body	Nero//Black		
91885	Telaio e cerchi ruota//Body and wheel rims	Grigio//Grey		
04450	Carrozzeria e ruote//Body and wheels	Panna/Cream	LAMBORGHINI	.
04452	Carrozzeria//Body	Azzurro/Blue	LANDINI	3311965M1
42071	Carrozzeria//Body	Grigio metallizzato/Metalic grey		1424900M1
88696	Carrozzeria//Body	Rosso/Red	LAVERDA	.
88697	Carrozzeria//Body	Rosso/Red	MANITOU	.
04452	Carrozzeria//Body	Azzurro/Blue	MASSEY FERGUSON	3311965M1
11122	Carrozzeria//Body	Rosso/Red		
11126	Telaio e motore//Body and engine	Marrone/Brown		
42071	Carrozzeria//Body	Grigio metallizzato/Metalic grey		1424900M1
11124	Carrozzeria e cerchi ruota//Body and wheel rims	Grigio antracite/Charcoal Grey		
37125	Latta da 3 Kg/3 Kg tin	Grigio metallizzato/Metalic grey		
04450	Carrozzeria e ruote//Body and wheels	Panna/Cream	SAME	.
04456	Carrozzeria//Body	Arancio/Orange		.
04458	Carrozzeria//Body	Arancio scuro/Dark orange		.
04467	Telaio e motore//Chassis and engine	Antracite/Carcoal		.
91162	Telaio e motore//Chassis and engine	Blu//Blue		.

### ANTIRUGGINE GRIGIO

ANTIROUILLE GRIS

ANTIRUST GREY

ROTSCHUTZ GRAU

ANTIOXIDANTE GRIS



**Note:** Latta da 1lt

**Notes:** 1lt tin

Art./Ref.	Note/Notes	Colore/Color
37947	Antiruggine/Antirust	Grigio/Grey

**SERIE DECALCOMANIE PER TRATTORI ADATTABILI FIAT**

SERIES DECALCOMANIES POUR TRACTEURS ADAPTABLE FIAT  
 TRANSFER DECALCOMANIES FOR TRACTORS ADAPTABLE FIAT  
 ABZIEHBILDER FÜR TRAKTOREN PASSEND ZU FIAT  
 SERIE DE CALOMANIA PARA TRACTORES ADAPTABLE FIAT

**Note:** Le serie sono complete di etichette istruzioni e comprendono tutte le decalcomanie

**Notes:** All series are supplied with instruction booklet and with all stickers

Art./Ref.	Note/Notes	Brand	Applicazione/Application
09601			25R
09606			211R
09607			215R
09621			411R
09623			415R
28580			100.90, 110.90
27936			65.90, 70.90, 80.90, 85.90
09633			250 DTH
09634			300 DTH
09635			350 DTH
09637			420 DTH
09638			450 DTH
09643			480 DTH
09644			500 DTH
09646			540 DTH
09647			550 DTH
09650			580 DTH
09651			600 DTH
09652	Trattori Fiat doppia trazione/Fiat 4x4 tractors	<b>FIAT</b>	640 DTH
09655			670 DTH
09656			680 DTH
09658			750 DTH
09661			780 DTH
09662			800 DTH
09663			850 DTH
09664			850 SPECIAL-OM
09665			880 DTH
09669			1000 DTH
09672			1300 DTH
10867			312C
10868	Trattori Fiat cingolati/Fiat tractor with tracks		332C
10876			455C
10878			505C
10879			555c
10881			605C
10884			665C
10886			765C

**CAVI COMANDO TRASMISSIONE CRONOGIROMETRO A CONTAGIRI ADATTABILI**

CABLE COMPTE-TOURS CHRONOGIROMETRE À COMPTE - TOURS ADAPTABLE

REVOLUTION-COUNTER TRANSMISSION CABLES ADAPTABLE

KABEL KILOMETERZÄHLER - STUNDENZÄHLER PASSEND ZU

CABLE DE MANDO TRANSMISSION CHRONOGIROMETRO CON CUENTA-REVOLUCIONES ADAPTABLE



Art./Ref.	Lunghezza mm/ Length mm	Ø esterno mm/ Outside Ø mm	Brand	Applicazione/Application	Rif. Orig./Orig. Ref.
<b>08476</b>	900	80	<b>FIAT</b>	100.90-100.90 DT, 110.90-110.90 DT, 350, 355, 420, 440, 45.66, 45.66-45.66 DT, 45.66S-45.66S DT, 450, 455, 465, 480, 50.66-50.66 DT, 50.66S-50.66S DT, 500, 505, 540, 55.65, 55.66, 55.90-55.90 DT, 56.66S-56.66S DT, 565, 570, 580, 60.65, 60.90-60.90 DT, 60.93-60.93 DT, 60.94-60.94 DT, 605, 640, 65.90-65.90 DT, 65.93-65.93 DT, 65.94-65.94 DT, 665, 670, 680, 70.65, 70.66, 70.90-70.90 DT, 72.93-72.93 DT, 72.94-72.94 DT, 765, 780, 80.50, 80.56, 80.65, 80.66, 80.76, 80.90-80.90 DT, 82.93-82.93 DT, 82.94-82.94 DT, 85.55, 85.90-85.90 DT, 855, 88.93-88.93 DT, 88.94-88.94 DT, 880, 90.90-90.90 DT, 95.55, 955, 980	4976720, 5108950, 5122475
<b>09124</b>	1150	80		1000, 1180, 1280, 1380, 300, 446, 55.46, 55.46 DT, 55.56, 55.56 DT, 55.66, 55.66 DT, 55.66S, 55.66S DT, 55.88, 55.88 DT, 566, 60.46, 60.46 DT, 60.56 DT, 60.66, 60.66 DT, 60.66S, 60.66S DT, 60.88, 60.88 DT, 65.46, 65.46 DT, 65.56, 65.56 DT, 65.66, 65.66 DT, 65.66S, 65.66S DT, 65.88, 65.88 DT, 666, 70.56, 70.56 DT, 70.66, 70.66 DT, 70.66S, 70.66S DT, 70.88, 70.88 DT, 766, 80.46, 80.50, 80.66, 80.66 DT, 80.66S, 80.66S DT, 80.70, 80.76, 80.88, 80.88 DT, F100, F100 DT, F110, F110 DT, F115, F115 DT, F120, F120 DT, F130, F130 DT, F140, F140 DT	4976770, 5112655, 585603
<b>09125</b>	1250	80		115.90-115.90 DT, 130.90-130.90 DT, 140.90-140.90 DT, 300, 650	4976718, 580780, 597617
<b>08476</b>	900	80	<b>FORD</b>	3435-3935-4135	4976720
<b>09125</b>	1250	80		8430	4976718
<b>08476</b>	900	80	<b>NEW HOLLAND</b>	TK100.55, TK55.65 F, TK55.65 M, TK55.65 V, TK55.75 F, TK55.75 M, TK55.75 V, TK55.85 F, TK55.85 M, TK55.85 V, TK60.65, TK60.65 M, TK60.65 V, TK60.75, TK60.75 M, TK60.75 V, TK60.85 F, TK60.85 M, TK60.85 V, TK62.85-TK62.85 M, TK70.65, TK70.65 M, TK70.75-TK70.75 M, TK72.85-TK72.85 M, TK80.65-TK80.75, TK82.85 M, TK85.55, TK88.85 M, TK95.55	4976720, 5108950
<b>09124</b>	1150	80		TK80.66 DT	5112655

**CAVO COMANDO ARRESTO MOTORE ADATTABILE**

ARRET MOTEUR AVEC CABLE ET GAINE ADAPTABLE

MOTOR STOP CABLE ADAPTABLE

ABSTELLZUG KPLT. MIT STAHLSEIL PASSEND ZU

CABLE DE MANDO CALADO DEL MOTOR ADAPTABLE



Art./Ref.	Brand	Applicazione/Application	Rif. Orig./Orig. Ref.
<b>08637</b>	<b>FIAT</b>	115.90 115.90DT, 130.90 130.90DT, 1380, 140.90 140.90DT, 55.46, 55.56-55.56 DT, 60.56 DT, 640, 680, 780, 880, 980	4999838, 5011872, 5113225, 5113249, 5113621, 5113622, 5153380
<b>08638</b>		100.90, 1180, 1580, 160.90-160.90 DT, 455C, 566, 666, 70.66, 70.66 DT, 70.66S, 766, 80.66, 80.66 DT, 80.66S, 80.66S DT, 80.76, 980	5104142, 5113254, 5113623, 5153381
<b>08637</b>	<b>FORD</b>	8430	5153380
<b>08638</b>		8630	5153381

**CAVO COMANDO DISINNESTO SOLLEVATORE ADATTABILE FIAT**

CABLE DEBRANCHEMENT BRAS DE RELEVAGE ADAPTABLE FIAT  
 LEVER CABLE FOR LIFT DISCONNECTION ADAPTABLE FIAT  
 KABEL AUSSCHALTUNGSHEBER ADAPTABLE FIAT  
 CABLE DE MANDO DESEMBRAGUE LEVANTADOR ADAPTABLE FIAT



Art./Ref.	Brand	Applicazione/Application	Rif. Orig./Orig. Ref.
<b>08469</b>	<b>FIAT</b>	580 DT, 680 DT, 780 DT, 880 DT, 980 DT	4999388

**CAVO ACCELERATORE MANUALE ADATTABILE FIAT**

CABLE ACCELERATEUR MANUEL ADAPTABLE FIAT  
 MANUAL ACCELERATOR CABLE ADAPTABLE FIAT  
 KABEL HANDGASHEBEL ADAPTABLE FIAT  
 CABLE ACELERADOR MANUAL ADAPTABLE FIAT



Art./Ref.	Brand	Applicazione/Application	Rif. Orig./Orig. Ref.
<b>08639</b>	<b>FIAT</b>	100.90, 440, 505C, 55.46, 55.46 DT, 55.56, 55.56 DT, 55.66, 55.66 DT, 55.66S, 55.66S DT, 566, 580, 60.46, 60.46 DT, 60.56 DT, 60.66, 60.66 DT, 60.66S, 60.66S DT, 65.46, 65.46 DT, 65.56, 65.56 DT, 65.66, 65.66 DT, 65.66S, 65.66S DT, 666, 680, 70.56, 70.56 DT, 70.66, 70.66 DT, 70.66S, 70.66S DT, 766, 780, 80.46, 80.66, 80.66 DT, 80.66S, 80.66S DT, 80.76, 880, 980	5121344, 5149955
<b>10587</b>		100.90-100.90 DT, 110.90-110.90 DT, 1180, 1280, 1380, 140.90-140.90 DT, 1580, 160.90-160.90 DT, 180.90-180.90 DT, 1880, 55.88-55.88 DT, 60.88-60.88 DT, 65.88-65.88 DT, 65.90-65.90 DT, 70.88-70.88 DT, 70.90-70.90 DT, 80.88-80.88 DT, 80.90-80.90 DT, 80.90.80.90 DT, 85.90-85.90 DT, 90.90-90.90 DT	5113158, 5127687, 5149956
<b>10587</b>	<b>FORD</b>	8430-8630-8830	5149956

**CAVO FRENO DI STAZIONAMENTO ADATTABILE FORD**

CABLE POUR FREIN DE STATIONNEMENT ADAPTABLE FORD  
 PARKING BRAKE CABLE ADAPTABLE FORD  
 KABEL FUER STANDBREMSE PASSEND ZU FORD  
 CABLE PARA FRENO DE MANO ADAPTABLE FORD



Art./Ref.	Brand	Applicazione/Application	Rif. Orig./Orig. Ref.
<b>14212</b>	<b>FORD</b>	4635, 4835, 5635, 6635, 7635	5183158
<b>14212</b>	<b>NEW HOLLAND</b>	L60, L65, L75, L85, L95, TL70, TL80, TL90, TL100	5171397, 5173940, 5174125, 5183158

**LEVA MULTIFUNZIONE ADATTABILE FIAT**

LEVIER MULTIFONCTION ADAPTABLE FIAT  
 MULTIFUNCTION LEVER ADAPTABLE FIAT  
 MULTIFUNKTIONSHABEL PASSEND ZU FIAT  
 PALANCA MULTIFUNCIONAL ADAPTABLE FIAT

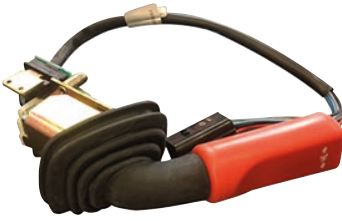

Art./Ref.	Note/Notes	Brand	Applicazione/Application	Rif. Orig./Orig. Ref.
<b>26974</b>	Neutro, Marcia avanti, Marcia indietro, Blocco/Neutral, Forward gear, Reverse gear, Block	<b>FIAT</b>	SERIE TN	47132543, 5170415

**TASSELLO ANTIVIBRANTE ADATTABILE FIAT**

CHEVILLE CAPOT ADAPTABLE FIAT  
 BONNET PLUG ADAPTABLE FIAT  
 EINSATZSTÜCKKOFER PASSEND ZU FIAT  
 CUNAS ANTIVIBRACIONES ADAPTABLE FIAT



Art./Ref.	Brand	Applicazione/Application	Rif. Orig./Orig. Ref.
<b>09127</b>	<b>FIAT</b>	100-90, 100-90 DT, 110-90, 110-90 DT, 115-90, 115-90 DT, 1180, 1280, 130-90, 130-90 DT, 1380, 140-90, 140-90 DT, 1580, 160-90, 160-90 DT, 180-90, 180-90 DT, 1880, 45.66, 55-90, 55-90 DT, 580, 60-90, 60-90 DT, 65-90, 65-90 DT, 680, 70-90, 70-90 DT, 780, 80-90, 80-90 DT, 880, 90-90, 90-90 DT, 980	5112704, 5125604

**CUFFIA PER TIRANTERIA FRENI ADATTABILE FIAT**

PROTECTEUR TIRANTS FREINS ADAPTABLE FIAT  
 BONNET BRAKE TIE ADAPTABLE FIAT  
 HAUBE BREMSGESTÄNGE PASSEND ZU FIAT  
 CAJA PARA TIRANTERÍA FRENOS ADAPTABLE FIAT



Art./Ref.	Brand	Applicazione/Application	Rif. Orig./Orig. Ref.
<b>08493</b>	<b>FIAT</b>	45.66-45.66DT-45.66S-45.66S DT, 45.76 V, 50.66-50.66DT-50.66S-50.66S DT, 50.86S V-50.86S V DT, 50.86V-50.86V DT, 55.66 F-55.66 F DT-55.66 LP, 55.66V-55.66 V DT, 55.66-55.66DT-55.66DT LP, 55.66S-55.66S DT, 55.76F - 55.76F DT, 55.76V-55.76V DT, 55.86F-55.86F DT, 55.86S V-55.86S V DT, 55.86V-55.86V DT, 56.66S-56.66S DT, 60.66-60.66 DT, 60.66F-60.66F DT, 60.66LP-60.66LP DT, 60.66S, 60.66S DT, 60.76F-60.76F DT, 60.86F-60.86F DT, 60.86S V-60.86S V DT, 60.86V-60.86V DT, 62.86F-62.86F DT, 65.66-65.66 DT, 65.66S-65.66S DT, 70.66S, 70.76F-70.76F DT, 70.76LP-70.76LP DT, 70.76V, 70.86S V, 70.86S V DT, 70.86V, 70.86V DT, 72.86 LP, 72.86 LP DT, 72.86F, 72.86F DT, 80.66, 80.66DT, 80.66F, 80.66F DT, 80.66S, 80.76F, 80.76F DT, 82.86 LP, 82.86F, 82.86F DT	5117518

**CUFFIA PER TIRANTERIA FRENI ADATTABILE**

PROTECTEUR TIRANTS FREINS ADAPTABLE  
 BONNET BRAKE TIE ADAPTABLE  
 HAUBE BREMSGESTÄNGE PASSEND ZU  
 CAJA PARA TIRANTERÍA FRENOS ADAPTABLE



Art./Ref.	Brand	Applicazione/Application	Rif. Orig./Orig. Ref.
08493	FORD	3435-3935-4135, 3830-4030-4230-4430	5117518
08493	NEW HOLLAND	TD3.50 - F480, TD5010-TD5020-TD5030, TD5040-TD5050, TD55D-TD60D-TD65D-TD70D, TD60-TD70-TD80-TD90-TD95, TD65B-TD4020F-TD4030F-TD4040F, TD65F-TD75F-TD85F, TD75D-TD80D-TD85D-TD90D-TD95D	5117518

**CUFFIA LEVA CAMBIO ADATTABILE FIAT**

PROTECTEUR LEVIER BOITE-VITESSE ADAPTABLE FIAT  
 BONNET GEAR LEVER ADAPTABLE FIAT  
 HAUBE GETRIEBEBEBEL PASSEND ZU FIAT  
 CAJA PARA PALANCA DEL CAMBIO ADAPTABLE FIAT



Art./Ref.	Brand	Applicazione/Application	Rif. Orig./Orig. Ref.
08474	FIAT	100, 110, 45.66, 465, 466, 50, 55, 55.65, 55.66, 565, 566, 570, 580, 60, 60.65, 60.66, 65.66, 665, 666, 670, 680, 70, 70.65, 70.66, 765, 766, 780, 80, 80.46, 80.56, 80.60, 80.65, 80.66, 80.70, 80.75, 80.76, 80.95, 85.55, 855, 880, 90, 95.55, 955, 980	4999009
14335			5132032
08474	FORD	3435-3935-4135	4999009
08474	NEW HOLLAND	T6030-T6050-T6070-T6080-T6090, T7.170-T7.185-T7.200-T7.210, T7.220-T7.235-T7.250-T7.260, T7030-T7040-T7050-T7060, TM175-TM190	4999009

**MOLLA IN GOMMA PER SEDILI ADATTABILE FIAT**

RESSORT CAOUTHOUC POUR SIEGES ADAPTABLE FIAT  
 RUBBER SPRING ADAPTABLE FIAT SEAT  
 GUMMIFEDER FÜR SITZE PASSEND ZU FIAT  
 MUELLE DE GOMA PARA ASIENTOS ADAPTABLE FIAT



Art./Ref.	Brand	Applicazione/Application	Rif. Orig./Orig. Ref.
06350	FIAT	1000, 1100, 350, 400, 420, 440, 450, 480, 500, 540, 640, 650, 700, 750, 800, 850, 900	595718



**CUFFIA PER FRENO A MANO ADATTABILE**

PROTECTEUR FREIN A MAIN ADAPTABLE  
 HANDBRAKE PROTECTION ADAPTABLE  
 HAUBE FÜR HANDBREMSE PASSEND ZU  
 CAJA PARA FRENO DE MANO ADAPTABLE



Art./Ref.	Brand	Applicazione/Application	Rif. Orig./Orig. Ref.
09128	FIAT	580, 680, 780, 80.60, 80.75, 80.95, 880, 980	5106733
09128	FORD	4635-4835-5635-6635-7635	5106733
09128	NEW HOLLAND	L60, L65, L75, L85, L95, NH75TLB-NH85TLB-NH95TLB, T5030-T5040-T5050-T5060-T5070, TL60-TL65-TL75-TL85-TL95, TL60E-TL75E-TL85E-TL95E, TL70, TL80, TL90, TL100, TL70A-TL80A-TL90A-TL100A	5106733

**CUFFIA PER LEVA CAMBIO ADATTABILE FIAT**

PROTECTEUR LEVIER BOITE-VITESSE ADAPTABLE FIAT  
 GEAR LEVER PROTECTION ADAPTABLE FIAT  
 HAUBE GETRIEBEHEBEL PASSEND ZU FIAT  
 CAJA PARA PALANCA DEL CAMBIO ADAPTABLE FIAT



Art./Ref.	Brand	Applicazione/Application	Rif. Orig./Orig. Ref.
08492	FIAT	570, 580, 670, 680, 780, 880, 980	5100995

**CUFFIA PIANTONE STERZO ADATTABILE FIAT**

PROTECTION TUBE DE EMBRAJAGE ADAPTABLE FIAT  
 STEERING COLUMN PROTECTION ADAPTABLE FIAT  
 HAUBE FÜR GETRIEBEHEBEL PASSEND ZU FIAT  
 CAJA PALANCA DE DIRECCION ADAPTABLE FIAT



Art./Ref.	Note/Notes	H mm	Foro mm/Hole mm	Brand	Applicazione/Application	Rif. Orig./Orig. Ref.
06351	Base = 155 x 80 mm	140	Ø 46	FIAT	115.90-115.90 DT, 1180, 1280, 130.90-130.90 DT, 1380, 140.90-140.90 DT, 1580, 160.90-160.90 DT, 180.90-180.90 DT, 1880	5110537
06351	Base = 155 x 80 mm	140	Ø 46	FORD	8430-8630-8830	5110537

**CUFFIE LEVA CAMBIO**

SOUFFLETS  
 BELLOWS  
 STAUBSCHUTZ  
 FUELLES PALANCA DE CAMBIO

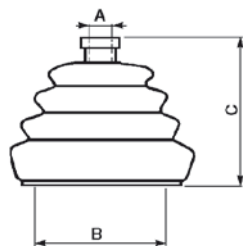

Art./Ref.	A mm	B mm	C mm	Note/Notes
<b>00289</b>	10	65	55	Motocoltivatori e trattorini Sep - Valpadana e vari
<b>00297</b>	10	60	85	Fiat 850 e vari/Fiat 850 and various
<b>00294</b>	13	56	70	Landini - Massey Fergusson - Same - Lamborghini
<b>00287</b>	13	82	75	Impieghi vari - Various applications

**CUFFIA PARAPOLVERE LEVA FRIZIONE ADATTABILE PASQUALI**

SOUFFLET POUR LEVIER EMBRAYAGE ADAPTABLE PASQUALI  
 CLUTCH LEVER DUST CAP ADAPTABLE PASQUALI  
 STAUBSCHUTZ KUPPLUNGHEBEL PASSEND ZU PASQUALI  
 FUELLES PRAPOLVO PARA PALANCA EMBRAQUE ADAPTABLE PASQUALI



Art./Ref.	Brand	Rif. Orig./Orig. Ref.
<b>00290</b>	<b>PASQUALI</b>	90028D

**TASSELLI ADATTABILI**

CHEVILLE CAPOT ADAPTABLE

BONNET PLUG ADAPTABLE

EINSATZSTÜCKOFFER PASSEND ZU

CUNAS ANTIVIBRACIONES ADAPTABLE

Art./Ref.	Note/Notes	Brand	Applicazione/Application	Rif. Orig./Orig. Ref.	Immagine/Image
<b>08473</b>	Tassello sportellino radiatore	<b>FIAT</b>	100.90-100.90 DT, 110.90-110.90 DT, 115.90-115.90 DT, 130.90-130.90 DT, 140.90-140.90 DT, 160.90-160.90 DT, 180.90-180.90 DT, 300, 35.66-35.66 DT, 350, 440, 45.66-45.66 DT, 45.66S 45.66S DT, 45.76 V, 450, 455, 465, 470, 474, 480, 50.66-50.66 DT, 50.66S-50.66S DT, 50.86V-50.86V DT, 50.86S V-50.86S V DT, 55.66 DT LP, 55.66 LP, 55.66 V-55.66 V DT, 55.66F-55.66F DT, 55.76 V-55.76 V DT, 55.76F-55.76F DT, 55.86 F-55.86 F DT, 55.86 V-55.86 V DT, 55.86S V-55.86S V DT, 55.88-55.88 DT, 55.90-55.90 DT, 56.66S-56.66S DT, 60.66 F-60.66F DT, 60.66 LP-60.66 LP DT, 60.76 F-60.76 F DT, 60.86 F-60.86 F DT, 60.86 V, 60.86S V, 60.86S V DT, 60.86V DT, 60.88-60.88 DT, 60.90-60.90 DT, 60.93-60.93 DT, 62.86 F-62.86 F DT, 65.88-65.88 DT, 65.90 DT, 65.90-65.90 DT, 65.93, 65.93-65.93 DT, 65.94-65.94 DT, 70.76 F-70.76 F DT, 70.76 LP-70.76 LP DT, 70.76 V, 70.86 V-70.86 V DT, 70.86S V-70.86S V DT, 70.88-70.88 DT, 70.90-70.90 DT, 72.86 F, 72.86 F DT, 72.86 LP-72.86 LP DT, 72.93-72.93 DT, 72.94-72.94 DT, 80.66 F-80.66 F DT, 80.76 F-80.76 F DT, 80.88-80.88 DT, 80.90-80.90 DT, 82.86 F, 82.86 F DT, 82.86 LP, 82.93-82.93 DT, 82.94-82.94 DT, 85.90-85.90 DT, 88.93-88.93 DT, 88.94-88.94 DT, 90.90-90.90 DT, F110-F110 DT, F115-F115 DT, F120-F120 DT, F130-F130 DT, F140-F140 DT	4068085, 5118180	
<b>08478</b>	Tassello per cofano/Bonnet plug		1000, 1300, 440, 450, 455, 480, 500, 505, 605, 640, 650, 655, 750, 805, 850	4955052, 591244	
<b>08600</b>	Tassello per cofano/Bonnet plug		1000, 440, 450, 455, 480, 500, 505, 605, 640, 655, 750, 805, 850	4952524	
<b>08602</b>	Tassello per cofano/Bonnet plug		100.90-100.90 DT, 110.90-110.90 DT, 115.90-115.90 DT, 1180, 1280, 130.90-130.90 DT, 1380, 140.90-140.90 DT, 1580, 160.90-160.90 DT, 180.90-180.90 DT, 1880, 55.90-55.90 DT, 580, 60.90-60.90 DT, 65.90-65.90 DT, 680, 70.90-70.90 DT, 780, 80.90-80.90 DT, 85.55, 85.90-85.90 DT, 855, 880, 90.90-90.90 DT, 955, 980	4996479	
<b>08605</b>	Tassello per cabina		100.90-100.90 DT, 110.90-110.90 DT, 55.88-55.88 DT, 55.90-55.90 DT, 580, 60.88-60.88 DT, 60.90-60.90 DT, 60.93-60.93 DT, 60.94-60.94 DT, 65.88-65.88 DT, 65.90-65.90 DT, 65.93.65.93 DT, 65.94-65.94 DT, 680, 70.88-70.88 DT, 70.90-70.90 DT, 72.93-72.93 DT, 72.94-72.94 DT, 780, 80.88-80.88 DT, 80.90-80.90 DT, 82.93-82.93 DT, 82.94-82.94 DT, 82.94.82.94 DT, 85.90-85.90 DT, 88.93-88.93 DT, 88.94-88.94 DT, 880, 90.90-90.90 DT, 980	4997423	
<b>08606</b>	Tassello per cofano/Bonnet plug		1000, 1100, 115.90-115.90 DT, 1180, 1280, 130.90-130.90 DT, 1300, 1380, 140.90-140.90 DT, 1580, 160.90-160.90 DT, 180.90-180.90 DT, 1880, 300, 350, 355, 400, 440, 450, 455, 480, 500, 505, 540, 605, 640, 650, 655, 700, 750, 800, 805, 850	5111459, 5118472	
<b>08473</b>	Tassello sportellino radiatore	<b>FORD</b>	3435-3935-4135, 3830-4030-4230-4430, 8430-8630-8830	5118180	
<b>08602</b>	Tassello per cofano/Bonnet plug		8430-8630-8830	5106927	
<b>08605</b>	Tassello per cabina/		4635-4835-5635-6635-7635	4997423	
<b>08606</b>	Tassello per cofano/Bonnet plug		8430-8630-8830	5111459, 5118472	
<b>08602</b>	Tassello per cofano/Bonnet plug	<b>NEW HOLLAND</b>	TK100.55, TK160.55, TK85.55, TK95.55	5106927	
<b>08605</b>	Tassello per cabina	<b>NEW HOLLAND</b>	L60, L65, L75, L85, L95, T5030-T5040-T5050-T5060-T5070, TL70-TL80-TL90-TL100, TL70A-TL80A-TL90A-TL100A	4997423	
<b>08606</b>	Tassello per cofano/Bonnet plug	<b>NEW HOLLAND</b>	T4020-T4030-T4040-T4050, TK160-55, TN60A-TN70A-TN75A-TN85A-TN95A	5111459, 5118472	

**IMPUGNATURA DISINNESTO FRIZIONE STERZO ADATTABILE FIAT**

POIGNEE DEBRAYAGE FRICTION DIRECTION ADAPTABLE FIAT  
 STEERING CLUTCH DISINGAGE HANDLE ADAPTABLE FIAT  
 AUSLOSUNGSGRIFF LENKUNGSKUPPLUNG PASSEND ZU FIAT  
 EMPUNADURA DESEMBRAGUE DEL EMBRAGUE DE DIRECCION ADAPTABLE FIAT



Art./Ref.	Brand	Applicazione/Application	Rif. Orig./Orig. Ref.
<b>08491</b>	<b>FIAT</b>	100 C, 120C, 1355C, 311 C, 355 C, 411 C, 45 C, 455 C, 50 C, 505 C, 555 C, 605 C, 60C, 655 C, 70 C, 80, 80 C, 80.50, 80.70, 805 C, 90 C	541001, 578159, 9966943

**CAVETTO PORTIERA ADATTABILE**

CABLE PORTIERE ADAPTABLE  
 DOOR CABLE ADAPTABLE FIAT  
 WAGENSCHLAGKABEL PASSEND ZU  
 CABLE PORTERA ADAPTABLE



Art./Ref.	Brand	Applicazione/Application	Rif. Orig./Orig. Ref.
<b>09129</b>	<b>FIAT</b>	140-90 DT, 1580, 160-90 DT, 180-90 DT, 55-88, 55-88 DT, 60-88, 60-88 DT, 65-88, 65-88 DT, 70-88, 70-88 DT, 780, 80-88, 80-88 DT	5120144
<b>09129</b>	<b>FORD</b>	8430, 8630, 8830	5120144

**ATTACCO MOLLA A GAS**

ATTAQUE RESSORT A GAZ  
 GAS SPRING CONNECTION  
 VERBINDUNGSTUECK GASFEDER  
 ATAGUE AMORTIGUADOR

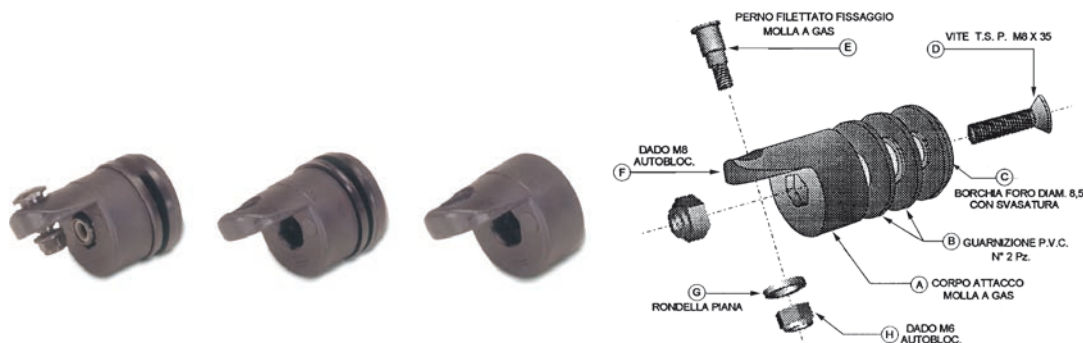

Art./Ref.	Note/Notes
<b>16673</b>	
<b>16674</b>	Corpo attacco molla a gas + 2 guarnizioni + borchia. Particolari A+B+C / Gas spring connection body with 2 seals and stud. Parts A+B+C
<b>16675</b>	Particolare A/Part A/

## PARTI CARROZZERIA ORIGINALI E ADATTABILI FIAT / NEW HOLLAND

PARTIES CORP ORIGINAL ET ADAPTABLE FIAT / NEW HOLLAND

BODY PARTS ORIGINAL AND ADAPTABLE FIAT / NEW HOLLAND

KAROSSEITEILE ORIGINAL UND PASSEND ZU FIAT / NEW HOLLAND

PARTES DE CARROCERIA ORIGINAL Y ADAPTABLE FIAT / NEW HOLLAND

Art./Ref.	Descrizione estesa/Extended Description	Brand	Applicazione/Application	Rif. Orig./Orig. Ref.	Immagine/Image
19060	Perno maniglia adattabile a rif. orig. 5139229	FIAT NEW HOLLAND	55.88, 55.90, 60.88, 60.90, 60.94, 65.88, 65.90, 65.94, 70.88, 70.90, 80.88, 80.90	5139229	
26459	Perno adattabile a Fiat rif. orig. 5178406 per modelli 140-90DT, 160-90DT, 180-90DT		140-90DT, 160-90DT, 180-90DT	5139230, 5178406	
27501	Guarnizione adattabile a Fiat rif. orig. 5113654		140-90DT, 160-90DT, 180-90DT	5113654	
29176	Supporto adattabile a rif. orig. Fiat 5120542		140-90DT, 160-90DT, 180-90DT	5120542	
27503	Guarnizione adattabile a Fiat rif. orig. 5121386		55-88, 55-88DT, 60-88, 60-88DT, 70-88, 70-88DT, 80-88, 80-88DT	5121386	
29141	Sportello anteriore destro adattabile a rif. orig. Fiat 5130899			5162985	
29142	Sportello anteriore sinistro adattabile a rif. orig. Fiat 5130899			5130899, 5162987	
29145	Sportello posteriore sinistro adattabile a rif. orig. Fiat 5162991			5130904, 5162991	
29146	Sportello posteriore destro adattabile a rif. orig. Fiat 5162989			5130901, 5162989	
26163	Sigla ditta adattabile a rif. orig. Fiat 4999997			4999997	
27932	Sigla ditta adattabile a rif. orig. Fiat 5136963			5136963	
26159	Sigla modello adattabile a rif. Orig. Fiat 5138081			5138081	
26160	Sigla modello laterale destro adattabile a rif. Orig. Fiat 5138082			5138082	
N05011672	Sportello in lamiera adattabile a rif. orig. Fiat 5011672			5011672	
35137	Perno adattabile a rif. orig. Fiat 5178206		100.90, 110.90, 115.90, 130.90, 140.90, 65.940, 70.88, 70.90, 72.940, 80.88, 80.90, 82.940, 85.90, 88.940, 90.90, TL100, TL70, TL80, TL90	5178206, 5178206	
29144	Ghiera adattabile a rif. orig. Fiat 5131923		45.66, 45.66DT, 50.66, 50.66DT, L60, L65, L75, L85, L95, TL100, TL70, TL80, TL90, TN55D-S, TN65D-S, TN65F, TN70D-S, TN70F, TN75D-S, TN75F, TN80F, TN90F, TN95F	5131923, 5131923	

Art./Ref.	Descrizione estesa/Extended Description	Brand	Applicazione/Application	Rif. Orig./Orig. Ref.	Immagine/Image
<b>29177</b>	Supporto adattabile a rif. orig. Fiat 5120543	<b>FIAT NEW HOLLAND</b>	140-90DT, 160-90DT, 180-90DT, F100, F100DT, F110, F110DT, F115, F115DT, F120, F120DT, F130, F130DT, F140, F140DT	5120543, 5120543	
<b>29140</b>	Pomello con filetto adattabile a Fiat rif. 5155778		4635,4835,5635,6635,7635, F100, F110, F115, F120, F130, F140, L60, L65, L75, L85, L95, T6.120, T6.140, T6.150, T6.155, T6.160, T6.165, T6.175, T6010, T6020, T6030, T6040, T6050, T6060, T6070, T6080, T6090, T7.170, T7.185, T7.200, T7.210, T7.220, T7.235, T7.250, T7.260, T7.270, T7030, T7040, T7050, T7060, T7070, TL100, TL100A, TL70, TL70A, TL80, TL80A, TL90, TL90A, TM135, TM150, TM165, TM180, TS100A, TS110A, TS115A, TS120, TS125A, TS130A, TS135A	5155778, 5155778, 84516592	
<b>29178</b>	Vite adattabile a rif. orig. Fiat 5177632		TL100, TL70, TL80, TL90	5177632	
<b>NH5128785</b> <small>ORIGINALE</small>	Cofano originale Fiat rif. 5128785			5128785	
<b>NH82007587</b> <small>ORIGINALE</small>	Pannello originale Fiat rif. 82007587			82007587	
<b>NH5130007</b> <small>ORIGINALE</small>	Rivestimento originale Fiat rif. 5130007			5130007	
<b>NH5195762</b> <small>ORIGINALE</small>	Riparo originale Fiat rif. 5195762			5195762	
<b>NH5132661</b> <small>ORIGINALE</small>	Mascherina originale Fiat rif. 5132661			5132661	
<b>NH9960972</b> <small>ORIGINALE</small>	Porta originale Fiat rif. 9960972			9960972	
<b>NH9960971</b> <small>ORIGINALE</small>	Porta originale Fiat rif. 9960971			9960971	
<b>NH248715A1</b> <small>ORIGINALE</small>	Parabrezza originale Fiat rif. 248715A1		248715A1		

**CERNIERA UNIVERSALE PER CABINE TRATTORI**

CHARNIERE UNIVERSELLE POUR CABINE TRACTEUR  
UNIVERSAL HINGE FOR TRACTOR CABS  
UIVERSALSCHARNIER KABINEN  
CIERRE UNIVERSAL PARA CABINAS DE TRACTORES

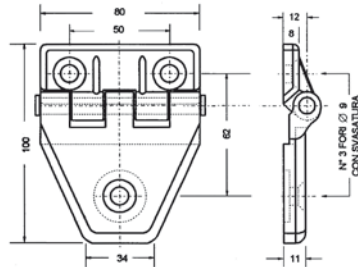

Art./Ref.  
**16679**

**PIASTRINA UNIVERSALE ADATTABILE FIAT**

PLAQUE UNIVERSELLE ADAPTABLE FIAT  
UNIVERSAL PLATE ADAPTABLE FIAT  
LASCHE PASSEND ZU FIAT  
PARTE ADAPTABLE FIAT



Art./Ref.	Brand	Applicazione/Application	Rif. Orig./Orig. Ref.
<b>27500</b>	<b>FIAT</b>	55.88, 55.88DT, 60/80DT, 60/88, 60/88DT, 65/88, 65/88DT, 70/88, 70/88DT, 80/88, 80/88DT, F100, F100DT, F110, F110DT, F115, F115DT, F120, F120DT, F130, F130DT, F140, F140DT	5130696

**GOMMINO DI PROTEZIONE PER VETRO**

GOMME DE PROTECTION POUR VERRE  
GLASS PROTECTION RUBBER GASKET  
GUMMIPUFFER (GLASSCHUTZ)  
GIUNTA DE PROTECCIÓN PARA VIDRIO

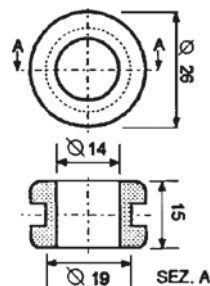

Art./Ref.  
**16680**

**DISTANZIALE PER GOMMINO DI PROTEZIONE VETRO**

ENTRETOISE POUR GOMME DE PROTECTION POUR VERRE  
SPACER FOR GLASS PROTECTION RUBBER GASKET  
DISTANZSTUECK GUMMIPUFFER  
DISTANCIADOR GIUNTA DE PROTECCIÓN PARA VIDRIO

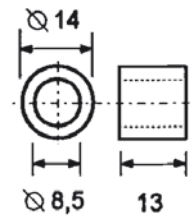

Art./Ref.  
**16681**

**DISTANZIALE CON TESTA PER GOMMINO PROTEZIONE VETRO**

ENTRETOISE POUR GOMME DE PROTECTION POUR VERRE  
SPACER FOR GLASS PROTECTION RUBBER GASKET  
DISTANZSTUECK GUMMIPUFFER  
DISTANCIADOR GIUNTA DE PROTECCIÓN PARA VIDRIO

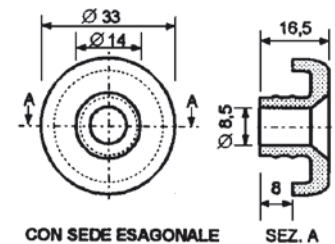

Art./Ref.  
**16682**

**TASSELLO DISTANZIALE PER CERNIERA**

GOIJON ENTRETOISE POUR CHARNIERE  
SPACER BONNET FOR HINGE  
EINSATZ FUER DISTANZSTUECK  
TOPE

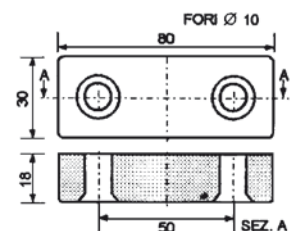

Art./Ref.  
**16683**

**BLOCCHETTO FISSAGGIO VETRO**

BLOC FIXAGE VERRE  
FIXING WINDOW BLOCK  
FIXIERUNGSTUECK  
BLOQUE PARA FISAJE VIDRIO

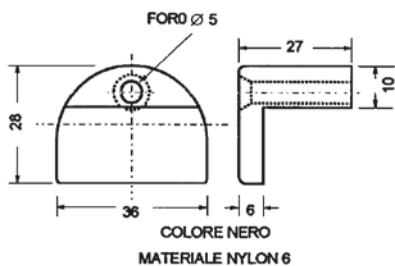

Art./Ref.
16676

**SOTTOVITI PER CABINE**

BOSSAGE  
UNDERSCREW WASHER  
GEWINDESTUETZEN  
DEBAJO DE TORNILLO

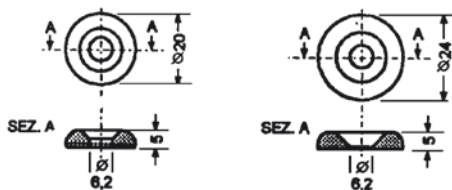

Note:  $\varnothing$  INTERNO 6,2MM  
Notes: INNER  $\varnothing$  6,2MM

Art./Ref.	$\varnothing$ esterno mm/Outside $\varnothing$ mm	Sede/Hole site
16671	20	Svasata
16672	24	Svasata

**BORCHIE SOTTOVITI UNIVERSALI PER CABINE**

BOSSAGE  
STUD FOR CABINS  
GEWINDESTUETZEN  
DEBAJO DE TORNILLO



Sede Svasata  
Countersunk hole site



Sede Esagonale  
Hexagonal hole site



Foro Passante  
Hole Through

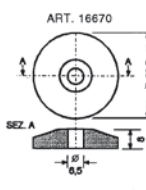
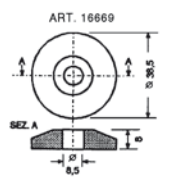
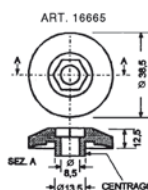
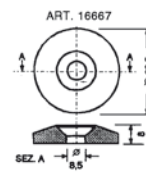
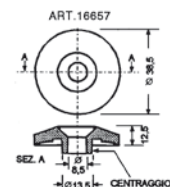
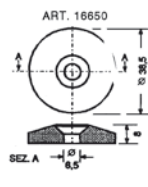

Note:  $\varnothing$  ESTERNO 38,5MM  
Notes:  $\varnothing$  ESTERNO 38,5MM

Art./Ref.	Sede/Hole site	Foro mm/Hole mm
16650	Svasata	6.5
16657	Svasata	8.5
16667	Svasata	8.5
16665	Esagonale	8.5
16670	Foro passante	6.5
16669	Foro passante	8.5



# 1.7.13 Archi di protezione

Roll Bars



## Ricambi & accessori per macchine agricole

SPARE PARTS & ACCESSORIES FOR AGRICULTURAL MACHINE

Tutti gli articoli della presente sezione, prodotti da AMA SPA e/o da terzi per conto di AMA, sono adattabili ("non originali") alle marche indicate ai sensi di quanto previsto dal REG. CE n. 1400/2002. I diritti sui marchi citati appartengono ai legittimi proprietari ed il loro uso ha l'esclusiva finalità di consentire all'utilizzatore la comparazione dei diversi prodotti. All items of this section, manufactured by AMA SPA and/or any third party on behalf of AMA, are adaptable ("non-original") to the brands listed under the provisions of the REG. CE n. 1400/2002. The rights on the trademarks belong to their respective owners and their usage is only aimed to allow the user to compare different products.

**CAPPOTTINA DELUXE PER TRATTORI**

CABINES UNIVERSELS POUR TRACTEUR  
 UNIVERSAL CABIN FOR TRACTORS  
 UNIVERSAL KABINEN FUER TRAKTOREN  
 CABINAS UNIVERSALES PARA TRACTORES

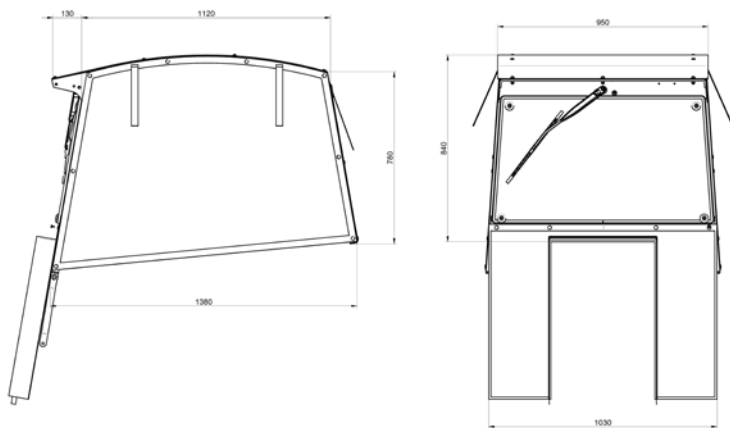

Art./Ref.	Descrizione/Description
<b>85610</b>	Cappottina deluxe applicabile su trattori gommati frutteti e vigneti con roll-bar anteriori/ Deluxe hood applicable on wheeled tractors for orchards and vineyards with front roll bars

**TETTUCCI PARAPIOGGIA UNIVERSALI**

AUVENT PARE-PLUIE UNIVERSELLE  
 UNIVERSAL RAIN COVERS  
 REGENDECKEL UNIVERSAL  
 COBERTURA PARA-LLUVIA UNIVERSAL

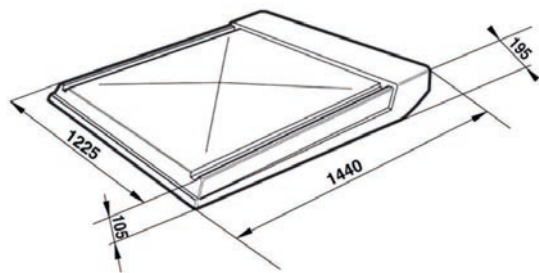

Art./Ref.
<b>89268</b>
<b>89269</b>

**ARCHI DI PROTEZIONE ANTERIORI ABBATTIBILI PER TRATTORI GOMMATI CARREGGIATA STRETTA**

ARCEAUX DE PROTECTION AVANT POUR TRACTEURS ROUES A VOIE ETROITE

FRONT ROLL BARS FOR WHEELED NARROW-TRACK TRACTORS

SCHUTZGERUESTE VORDERSEITE FUER BAEDRIGE TRAKTOREN

ARCOS PROTECTORES FRENTE PARA TRACTORES DE RUEDAS, DE VIA ESTRECHA

**Note:** Archi di protezione antiribaltamento per trattori agricoli di tutti i tipi costruiti in conformità alle leggi italiane in materia di sicurezza sul lavoro. Il Decreto Legislativo del 9 aprile 2008 prevede l'adeguamento di tutte le trattori sprovviste di protezione. Certificati di omologazione in conformità alle linee guida Ispeel.

Ogni arco è dotato di tutto il necessario per il completo montaggio.

**Notes:** Anti-overturning roll bars for each type of farm tractors, manufactured in accordance with Italian laws about safety at work. The Legislative Decree of 9 April 2008 contemplates the adaptations of all the farm tractors not equipped with protection. Certificate of approval in accordance with the Ispeel guidelines.

Each roll bar is provided with all the necessary equipment for the complete assembly.

Art./Ref.	Brand	Applicazione/Application	
85353	AGRIFULL	345 R - 350 DT	
85358	BERTOLINI	433 N	
85338	CARRARO	TIGRONE 4800	
85339		4400, 5000	
85340		TIGRONE 7000 E SIMILARI	
85341		6000 E SIMILARI (ASSALE A 45	
85342		SUPERTIGRE 850	
85343		SUPERTIGRE 835 - 841	
85352		FERRARI	95 RS
85316	FIAT	474 DT E SIMILARI	
85317		55-66	
85319		480 R	
85320		500	
85321		670 DTF (VERIFICARE ALT PARAF)	
85322		250, 300	
85323		211	
85361	FORD	3600	
85362		4110	
85351	GRILLO	31 V	
85332	LAMBORGHINI	R 235	
85333		R 503	
85334		653 DTF	
85335	LANDINI	880	
85336		5505	
85337	MASSEY FERGUSON	135	
85359	MCCORMICK	INTERNATIONAL 633	
85360		INTERNATIONAL 433	
85354	PASQUALI	959 - 988 - 425 E SIMILARI	
85355		980	
85356		439 - 492	
85357		959/410	
85324	SAME	MINITAURO 60	
85325		CORSARO 70	
85326		AURORA 45	
85327		RANGER 45	
85328		ITALA 35	
85329		DELFINO 35	
85330		SAMETTO V	
85331		SIRENETTA	
85344		VALPADANA	555 RS E SIMILARI
85345			6045 RS-6060 RS-7070 RS E SIMI
85346	6045 DT		
85348	330 RS		



**ARCHI DI PROTEZIONE POSTERIORI ABBATTIBILI PER TRATTORI GOMMATI CARREGGIATA STANDARD**
*ARCEAUX ARRIERE POUR TRACTEURS A ROUES A VOIE NORMALE*
*REAR ROLL BARS FOR WHEELED NARROW-TRACK TRACTORS*
*SICHERHEITSGERUESTE FUER ZUGMASCHINEN AUF RADERN SCHMALSPUR LEHRE*
*ARCO PROTECTORES TRASERO PARA TRACTORES DE TROCHA ESTANDAR*

**Note:** Archi di protezione antiribaltamento per trattori agricoli di tutti i tipi costruiti in conformità alle leggi italiane in materia di sicurezza sul lavoro. Il Decreto Legislativo del 9 aprile 2008 prevede l'adeguamento di tutte le trattori sprovviste di protezione. Certificati di omologazione in conformità alle linee guida Ispesl.

Ogni arco è dotato di tutto il necessario per il completo montaggio.

**Notes:** Anti-overturning roll bars for each type of farm tractors, manufactured in accordance with italian laws about safety at work. The Legislative Decree of 9 april 2008 contemplates the adaptations of all the farm tractors not equipped with protection. Certificate of approval in accordance with the Ispesl guidelines.

Each roll bar is provided with all the necessary equipment for the complete assemblage.

Art./Ref.	Brand	Applicazione/Application	
85275	<b>CARRARO</b>	6500	
85276		230, 4500	
85259	<b>FIAT</b>	400, 450, 500, 540, 550 E SIMILARI, 600, 640, CON PARAFANGHI QUADRATI	
85260		400, 450, 500, 540, 550 E SIMILARI, 600, CON PARAFANGHI TONDI	
85261		450, 500, 540, 550 E SIMILARI, 600	
85262		315, 415	
85263		311, 411	
85264		1000, 800	
85265		70-66 DTF	
85266		70-66 LP	
85267		211 R	
85268		215 N	
85269		420	
85270		45-66	
85271		615, 715	
85272		650 FIAT OM, 750 FIAT OM	
85273		513 FIAT OM	
85274		50 R FIAT OM	
85283		<b>FORD</b>	2000
85284			3000, 3000Y
85285			3055, 4000, 4600, 6600
85286	5000		
85313	<b>JOHN DEERE</b>	2020	
85314		2120	
85287	<b>LAMBORGHINI</b>	R 470 DT	
85288		R 583	
85289		2R	
85290		3352, 340 N	
85291		R 230	
85277	<b>LANDINI</b>	5500 R	
85278		CON ASSALE DRITTO, R5000, R5000 N, R5000 S	
85279		6530 F	
85280		R 7000	
85281		R 3200	
85282		R 4000, R 4500	
85305		135	
85306	<b>MASSEY FERGUSON</b>	165 MARK III	
85307		35	
85315	<b>MCCORMICK</b>	INTERNATIONAL 433	
85292	<b>SAME</b>	LEONE 75	
85293		CONDOR 55, MINITAURO	
85294		CENTAURO E SIMILARI	
85295		ITALIA 35	
85296		450 V	

Art./Ref.	Brand	Applicazione/Application
85297	<b>SAME</b>	FALCON
85298		SATURNO 80
85299		SAMETTO V
85300		PULEDRO
85301		ATLANTA
85302		AURORA
85303		SAMETTO 120 (SERIE AUTOMAZ)
85304		DRAGO
85309	<b>STEYR</b>	80
85310		540 DT
85311		650
85312		18



**ARCHI DI PROTEZIONE POSTERIORI ABBATTIBILI PER TRATTORI CINGOLATI**

ARCEAUX ARRIERE POUR TRACTEURS CHENILLES

REAR ROLL BARS FOR TRACKED TRACTORS

SICHERHEITSGERUESTE FUER RAUPENTRAKTOREN

ARCO PROTECTORES TRASERO PARA TRACTORES SOBRE ORUGAS

**Note:** Archi di protezione antiribaltamento per trattori agricoli di tutti i tipi costruiti in conformità alle leggi italiane in materia di sicurezza sul lavoro. Il Decreto Legislativo del 9 aprile 2008 prevede l'adeguamento di tutte le trattori sprovviste di protezione. Certificati di omologazione in conformità alle linee guida Ispesl.

Ogni arco è dotato di tutto il necessario per il completo montaggio.

**Notes:** Anti-overturning roll bars for each type of farm tractors, manufactured in accordance with Italian laws about safety at work. The Legislative Decree of 9 April 2008 contemplates the adaptations of all the farm tractors not equipped with protection. Certificate of approval in accordance with the Ispesl guidelines.

Each roll bar is provided with all the necessary equipment for the complete assemblage.

Art./Ref.	Brand	Applicazione/Application	
85233	AGRIFULL	355 C	
85234		235 LL	
85235		340 L	
84700	FIAT	312C, 411C, 451C, 505C SUPER, 605C	
85201		455C	
85202		55-65 - 55-75 E SIMILARI	
85203		665C E SIMILARI	
85204		312C	
85205		70-65 - 80-65 E SIMILARI	
85206		60C	
85207		95-55	
85208		OM 655	
85209		465 C	
85227		ITMA	180 L - 300 L
85228			301 L
85229	235N-345N-322N E SIMILARI		
85230	500		
85231	401 L		
85232	600 N		
85215	LAMBORGHINI	C352 - C453 E SIMILARI	
85216		C583 - C653 - C554 - C664 ERGO	
85218		C 754 L	
85217	C 340		
85219	C 774-80		
85220	LANDINI	4500 E SIMILARI	
85221		5830 E SIMILARI	
85222		6030	
85223		7800	
85224		CL 5500	
85225		6830 F (SPECIF.LARGH RIDUTT)	
85226	CL 4000 SPECIAL		
85210	SAME	FOX 55 C	
85211		FALCON C	
85212		MINITAURO 60 C	
85213		FOX 35 C	
85214		TAURUS	



**ARCHI DI PROTEZIONE POSTERIORI ABBATTIBILI PER MOTOAGRICOLE**
*ARCEAUX ARRIERE POUR TRANSPORTEURS*
*REAR ROLL BARS FOR TRANSPORTERS*
*SICHERHEITSGERUESTE FUER TRANSPORTER*
*ARCO PROTECTORES TRASERO PARA TRANSPORTADORES*

**Note:** Archi di protezione antiribaltamento per trattori agricole di tutti i tipi costruiti in conformità alle leggi italiane in materia di sicurezza sul lavoro. Il Decreto Legislativo del 9 aprile 2008 prevede l'adeguamento di tutte le trattori sprovviste di protezione. Certificati di omologazione in conformità alle linee guida IspeSl. Ogni arco è dotato di tutto il necessario per il completo montaggio.

**Notes:** Anti-overturning roll bars for each type of farm tractors, manufactured in accordance with Italian laws about safety at work. The Legislative Decree of 9 April 2008 contemplates the adaptations of all the farm tractors not equipped with protection. Certificate of approval in accordance with the IspeSl guidelines. Each roll bar is provided with all the necessary equipment for the complete assemblage.

Art./Ref.	Brand	Applicazione/Application
85251	<b>BERTOLINI</b>	326
85252		TA 5000
85253		B 1175
85255	<b>CARON</b>	A32
85256		TS52
85246	<b>CARRARO</b>	TIGRE TRANS
85247		TIGRECAR 3200
85248		TIGRECAR 5000 - 3700
85258	<b>FERRARI</b>	94 L
85254	<b>GOLDONI</b>	TRANSCAR 40
85245	<b>GRILLO</b>	93 A 951
85243	<b>PASQUALI</b>	946 - 410
85244		446
85249	<b>VALPADANA</b>	2026 E SIMILARI
85250		1820 - 2030

## ARCHI DI PROTEZIONE POSTERIORI PER TRATTORI CINGOLATI

ARCEAUX DE PROTECTION

SAFETY ROLL BARS

SCHUTZGERUESTE

ARCOS PROTECTORES



**Note:** Archi di protezione antiribaltamento per trattori agricole omologati secondo i codici Ocse.

**Notes:** *Rolls bars anti-overturning approved for agricultural tractors in accordance with the codes Ocse*

Art./Ref.	Brand	Applicazione/Application
85236	FIAT	605C - 451C E SIMILARI
85237		455C
85239		665C E SIMILARI
85240		312C
85241		70-65 - 80-65 E SIMILARI
85242		465C

**Su richiesta, sono fornibili archi per tutte le macchine non indicate.**

# 1.7.14 Frizioni

Clutches



**Ricambi & accessori per macchine agricole**  
SPARE PARTS & ACCESSORIES FOR AGRICULTURAL MACHINE

Tutti gli articoli della presente sezione, prodotti da AMA SPA e/o da terzi per conto di AMA, sono adattabili ("non originali") alle marche indicate ai sensi di quanto previsto dal REG. CE n. 1400/2002. I diritti sui marchi citati appartengono ai legittimi proprietari ed il loro uso ha l'esclusiva finalità di consentire all'utilizzatore la comparazione dei diversi prodotti. All items of this section, manufactured by AMA SPA and/or any third party on behalf of AMA, are adaptable ("non-original") to the brands listed under the provisions of the REG. CE n. 1400/2002. The rights on the trademarks belong to their respective owners and their usage is only aimed to allow the user to compare different products.



**KIT FRIZIONE ADATTABILE RIF. 9973691 AGRIFULL**

KIT EMBRAYAGE ADAPTABLE REF. 9973691 AGRIFULL

KIT CLUTCH ADAPTABLE REF. 9973691 AGRIFULL

KIT KUPPLUNG PASSEND ZU REF. 9973691 AGRIFULL

KIT EMBRAGUE ADAPTABLE REF. 9973691 AGRIFULL

Art./Ref.	Note/Notes	Brand	Applicazione/Application	Rif. Orig./Orig. Ref.	Immagine/Image
<b>57940</b>	Kit composto da - Kit consists of: - Meccanismo/Clutch Ref. 5162900 With box Original CNH - Disco Pto/Disc Pto Ref. 5154703 Not Original - Cuscinetto/Bearing Ref. 5122028 Not Original - Cuscinetto/Bearing Ref. 24905360 Not Original	<b>AGRIFULL</b>	60 II F - 70 II F - 80 II F	9973691	   
<b>NH5162900</b>	Meccanismo Frizione 11" - Fiat originale/Clutch 11" - Original Fiat		60 II F - 70 II F - 80 II F	47512400, 5162900	
<b>26988</b>	Disco Pto Diametro 280 mm / Pto Disc Diameter 280 mm		60 II F - 70 II F - 80 II F	5145715, 5154703	
<b>12841</b>	Cuscinetto reggispinta 90 x 50 x 21,60 mm / Thrust Bearing 90 x 50 x 21,60 mm		55.46 - 55.66, 60 II/F/DT, 65.46, 70 II/F/DT, 80 II/F/DT, 8045 - 8050 - 8055, 8060 - 8065 - 8075, 8085 - 8095 - 8105, DERBY 60 - 80, GRISO 70 - 75, JOLLY 50, RODEO 90 - 95, TORNADO 80, TOSELLI 60 - 70 - 85	5122028	
<b>14882</b>	Cuscinetto pto 110 x 70 x 20 mm / Pto Bearing 110 x 70 x 20 mm/		60 II F - 70 II F - 80 II F	24905360	
<b>84025</b>	Kit composto da - Kit consists of: - Meccanismo/Clutch Ref. 5162900 With box Original LUK - Disco Pto/Disc Pto Ref. 5154703 Not Original - Cuscinetto/Bearing Ref. 5122028 Not Original - Cuscinetto/Bearing Ref. 24905360 Not Original		<b>AGRIFULL</b>	60 II F - 70 II F - 80 II F	9973691

Art./Ref.	Note/Notes	Brand	Applicazione/Application	Rif. Orig./Orig. Ref.	Immagine/Image
07859	Meccanismo Frizione 11" - Luk originale/ Clutch 11" - Original Luk	AGRIFULL	60 II F - 70 II F - 80 II F	47512400, 5162900	
26988	Disco Pto Diametro 280 mm - Pto Disc Diameter 280 mm		60 II F - 70 II F - 80 II F	5145715, 5154703	
12841	Cuscinetto reggispinta 90 x 50 x 21,60 mm / Thrust Bearing 90 x 50 x 21,60 mm		55.46 - 55.66, 60 II F/DT, 65.46, 70 II F/DT, 80 II F/DT, 8045 - 8050 - 8055, 8060 - 8065 - 8075, 8085 - 8095 - 8105, DERBY 60 - 80, GRISO 70 - 75, JOLLY 50, RODEO 90 - 95, TORNADO 80, TOSELLI 60 - 70 - 85	5122028	
14882	Cuscinetto pto 110 x 70 x 20 mm / Pto Bearing 110 x 70 x 20 mm		60 II F - 70 II F - 80 II F	24905360	

LUK628105310	Kit tutto originale LUK composto da - Kit all LUK original consists of: - Meccanismo/Clutch Ref. 228 0098 10 - Disco Pto/Disc Pto 328 0186 16 - Cuscinetto/Bearing Ref. 500 0459 00 - Cuscinetto/Bearing Ref. 500 0284 00 - Cuscinetto/Bearing Ref. 410 0025 00	AGRIFULL	60 II F - 70 II F - 80 II F	9973691	     
07859	Meccanismo Frizione 11" - Luk originale/Clutch 11" - Original Luk		60 II F - 70 II F - 80 II F	47512400, 5162900	
07852	Disco Pto Diametro 280 mm Luk originale - Pto Disc Diameter 280 mm Original Luk		60 II F - 70 II F - 80 II F	5145715, 5154703	
LUK500045900	Cuscinetto reggispinta 90 x 50 x 21,60 mm / Thrust Bearing 90 x 50 x 21,60 mm		60 II F - 70 II F - 80 II F, DERBY 60 - 80, GRISO 70 - 75, JOLLY 50, RODEO 90 - 95, TORNADO 80, TOSELLI 60 - 70 - 85, TOSELLI 8085 - 8095 - 8105	5122028	
LUK500028400	Cuscinetto pto 110 x 70 x 20 mm / Pto Bearing 110 x 70 x 20 mm/		60 II F - 70 II F - 80 II F	24905360	
LUK410002500	Cuscinetto volano 47 x 17 x 14 mm - Bearing 47 x 17 x 14 mm		60 II F - 70 II F - 80 II F	28043280	

**KIT FRIZIONE ADATTABILE RIF. 9973696 AGRIFULL**





KIT EMBRAYAGE ADAPTABLE REF. 9973696 AGRIFULL



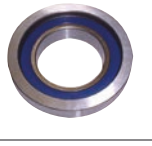

KIT CLUTCH ADAPTABLE REF. 9973696 AGRIFULL

KIT KUPPLUNG PASSEND ZU REF. 9973696 AGRIFULL

KIT EMBRAGUE ADAPTABLE REF. 9973696 AGRIFULL

Art./Ref.	Note/Notes	Brand	Applicazione/Application	Rif. Orig./Orig. Ref.	Immagine/Image
<b>57941</b>	Kit composto da - Kit consists of: - Meccanismo/Clutch Ref. 5163936 With box Original CNH - Disco Pto/Disc Pto Ref. 5154514 Not Original - Cuscinetto/Bearing Ref. 5122028 Not Original - Cuscinetto/Bearing Ref. 5112084 Not Original	<b>AGRIFULL</b>	TOSELLI 8085 - 8095 - 8105	9973696	   
<b>NH5163936</b>	Meccanismo Frizione 12" - Fiat originale/Clutch 12" - Original Fiat		TOSELLI 8085 - 8095 - 8105	5163936	
<b>26990</b>	Disco Pto Diametro 310 mm - Pto Disc Diameter 310 mm		TOSELLI 8085 - 8095 - 8105	5154514	
<b>12841</b>	Cuscinetto reggispinta 90 x 50 x 21,60 mm / Thrust Bearing 90 x 50 x 21,60 mm		55.46 - 55.66, 60 II/F/DT, 65.46, 70 II/F/DT, 80 II/F/DT, 8045 - 8050 - 8055, 8060 - 8065 - 8075, 8085 - 8095 - 8105, DERBY 60 - 80, GRISO 70 - 75, JOLLY 50, RODEO 90 - 95, TORNADO 80, TOSELLI 60 - 70 - 85	5122028	
<b>15545</b>	Cuscinetto pto 115 x 75 x 20 mm / Pto Bearing 115 x 75 x 20 mm		TOSELLI 8085 - 8095 - 8105	5112084	
<b>84028</b>	Kit composto da - Kit consists of: - Meccanismo/Clutch Ref. 5163936 With box Original LUK - Disco Pto/Disc Pto Ref. 5154514 Not Original - Cuscinetto/Bearing Ref. 5122028 Not Original - Cuscinetto/Bearing Ref. 5112084 Not Original		<b>AGRIFULL</b>	TOSELLI 8085 - 8095 - 8105	9973696

Art./Ref.	Note/Notes	Brand	Applicazione/Application	Rif. Orig./Orig. Ref.	Immagine/Image
07864	Meccanismo Frizione 12" - Luk Originale/Clutch 12" - Original Luk	AGRIFULL	TOSELLI 8085 - 8095 - 8105	5163936	
26990	Disco Pto Diametro 310 mm - Pto Disc Diameter 310 mm		TOSELLI 8085 - 8095 - 8105	5154514	
12841	Cuscinetto reggispinta 90 x 50 x 21,60 mm / Thrust Bearing 90 x 50 x 21,60 mm		55.46 - 55.66, 60 II/F/DT, 65.46, 70 II/F/DT, 80 II/F/DT, 8045 - 8050 - 8055, 8060 - 8065 - 8075, 8085 - 8095 - 8105, DERBY 60 - 80, GRISO 70 - 75, JOLLY 50, RODEO 90 - 95, TORNADO 80, TOSELLI 60 - 70 - 85	5122028	
15545	Cuscinetto pto 115 x 75 x 20 mm / Pto Bearing 115 x 75 x 20 mm		TOSELLI 8085 - 8095 - 8105	5112084	

LUK631106810	Kit tutto originale LUK composto da - Kit all LUK original consists of: - Meccanismo/Clutch Ref. 231 0049 19 - Disco Pto/Disc Pto 331 0132 16 - Cuscinetto/Bearing Ref. 500 0459 00 - Cuscinetto/Bearing Ref. 500 1292 10 - Cuscinetto/Bearing Ref. 410 0026 00	AGRIFULL	TOSELLI 8085 - 8095 - 8105	9973696	    
07864	Meccanismo Frizione 12" - Luk Originale/Clutch 12" - Original Luk		TOSELLI 8085 - 8095 - 8105	5163936	
07866	Disco Pto Diametro 310 mm Luk originale - Pto Disc Diameter 310 mm Original Luk		TOSELLI 8085 - 8095 - 8105	5154514	
LUK500045900	Cuscinetto reggispinta 90 x 50 x 21,60 mm / Thrust Bearing 90 x 50 x 21,60 mm		60 II F - 70 II F - 80 II F, DERBY 60 - 80, GRISO 70 - 75, JOLLY 50, RODEO 90 - 95, TORNADO 80, TOSELLI 60 - 70 - 85, TOSELLI 8085 - 8095 - 8105	5122028	
LUK500129210	Cuscinetto pto 115 x 75 x 20 mm / Pto Bearing 115 x 75 x 20 mm		TOSELLI 8085 - 8095 - 8105	5112084	











**KIT FRIZIONE LUK ADATTABILE RIF. 87689657 AGRIFULL**

KIT EMBRAYAGE LUK ADAPTABLE REF. 87689657 AGRIFULL

KIT CLUTCH LUK ADAPTABLE REF. 87689657 AGRIFULL

KIT KUPPLUNG LUK PASSEND ZU REF. 87689657 AGRIFULL

KIT EMBRAGUE LUK ADAPTABLE REF. 87689657 AGRIFULL

Art./Ref.	Note/Notes	Brand	Applicazione/Application	Rif. Orig./Orig. Ref.	Immagine/Image
<b>LUK628103410</b>	Kit tutto originale LUK composto da - Kit all LUK original consists of: - Meccanismo/Clutch Ref. 228 0077 17 - Disco Pto/Disc Pto 328 0186 16 - Cuscinetto/Bearing Ref. 500 0459 00 - Cuscinetto/Bearing Ref. 500 0284 00 - Cuscinetto/Bearing Ref. 410 0025 00	<b>AGRIFULL</b>	TOSELLI 55.46 - 55.66, TOSELLI 60 - 70 - 85, TOSELLI 60 II F DT, TOSELLI 65.46, TOSELLI 70 II F DT, TOSELLI 80 II F DT, TOSELLI 8045 - 8050, TOSELLI 8050 - 8055, TOSELLI 8060 - 8075, TOSELLI DERBY 60 - 80, TOSELLI GRISO 70 - 75, TOSELLI JOLLY 50, TOSELLI RODEO 90 - 95, TOSELLI TORNADO 80	87689657	    
<b>07850</b>	Meccanismo Frizione 11" - Luk originale/Clutch 11" - Original Luk		TOSELLI 55.46 - 55.66, TOSELLI 60 - 70 - 85, TOSELLI 60 II F DT, TOSELLI 65.46, TOSELLI 70 II F DT, TOSELLI 80 II F DT, TOSELLI 8045 - 8050, TOSELLI 8050 - 8055, TOSELLI 8060 - 8075, TOSELLI DERBY 60 - 80, TOSELLI GRISO 70 - 75, TOSELLI JOLLY 50, TOSELLI RODEO 90 - 95, TOSELLI TORNADO 80	47512408, 5154879, 5171137	
<b>07852</b>	Disco Pto Diametro 280 mm Luk originale - Pto Disc Diameter 280 mm Original Luk		60 II F - 70 II F - 80 II F, TOSELLI 55.46 - 55.66, TOSELLI 60 - 70 - 85, TOSELLI 60 II F DT, TOSELLI 65.46, TOSELLI 70 II F DT, TOSELLI 80 II F DT, TOSELLI 8045 - 8050, TOSELLI 8050 - 8055, TOSELLI 8060 - 8075, TOSELLI DERBY 60 - 80, TOSELLI GRISO 70 - 75, TOSELLI JOLLY 50, TOSELLI RODEO 90 - 95, TOSELLI TORNADO 80	5145715, 5154703	
<b>LUK500045900</b>	Cuscinetto reggispinta 90 x 50 x 21,60 mm / Thrust Bearing 90 x 50 x 21,60 mm		60 II F - 70 II F - 80 II F, DERBY 60 - 80, GRISO 70 - 75, JOLLY 50, RODEO 90 - 95, TORNADO 80, TOSELLI 60 - 70 - 85, TOSELLI 8085 - 8095 - 8105	5122028	
<b>LUK500028400</b>	Cuscinetto pto 110 x 70 x 20 mm / Pto Bearing 110 x 70 x 20 mm		60 II F - 70 II F - 80 II F, TOSELLI 55.46 - 55.66, TOSELLI 60 - 70 - 85, TOSELLI 60 II F DT, TOSELLI 65.46, TOSELLI 70 II F DT, TOSELLI 80 II F DT, TOSELLI 8045 - 8050, TOSELLI 8050 - 8055, TOSELLI 8060 - 8075, TOSELLI DERBY 60 - 80, TOSELLI GRISO 70 - 75, TOSELLI JOLLY 50, TOSELLI RODEO 90 - 95, TOSELLI TORNADO 80	24905360	
<b>LUK410002500</b>	Cuscinetto volano 47 x 17 x 14 mm - Bearing 47 x 17 x 14 mm		60 II F - 70 II F - 80 II F, TOSELLI 55.46 - 55.66, TOSELLI 60 - 70 - 85, TOSELLI 60 II F DT, TOSELLI 65.46, TOSELLI 70 II F DT, TOSELLI 80 II F DT, TOSELLI 8045 - 8050, TOSELLI 8050 - 8055, TOSELLI 8060 - 8075, TOSELLI DERBY 60 - 80, TOSELLI GRISO 70 - 75, TOSELLI JOLLY 50, TOSELLI RODEO 90 - 95, TOSELLI TORNADO 80	28043280	

**KIT FRIZIONE ADATTABILE RIF. 9973691 CASE**

KIT EMBRAYAGE ADAPTABLE REF. 9973691 CASE

KIT CLUTCH ADAPTABLE REF. 9973691 CASE

KIT KUPPLUNG PASSEND ZU REF. 9973691 CASE

KIT EMBRAGUE ADAPTABLE REF. 9973691 CASE

Art./Ref.	Note/Notes	Brand	Applicazione/Application	Rif. Orig./Orig. Ref.	Immagine/Image
57940	Kit composto da - Kit consists of: - Meccanismo/Clutch Ref. 5162900 With box Original CNH - Disco Pto/Disc Pto Ref. 5154703 Not Original - Cuscinetto/Bearing Ref. 5122028 Not Original - Cuscinetto/Bearing Ref. 24905360 Not Original	CASE	AVJ55, AVJ60, AVJ70, JX85, JX90, VJ60, VJ70, VJ80	9973691	
NH5162900	Meccanismo Frizione 11" - Fiat originale/Clutch 11" - Original Fiat		AVJ55, AVJ60, AVJ70, JX85, JX90, VJ60, VJ70, VJ80	47512400, 5162900	
26988	Disco Pto Diametro 280 mm - Pto Disc Diameter 280 mm		JX85, JX90, VJ80	5145715, 5154703	
12841	Cuscinetto reggispinta 90 x 50 x 21,60 mm / Thrust Bearing 90 x 50 x 21,60 mm		2140, 2120, 2130, 2150, FARMALL 75C/55C/65C, JX1060V/C, JX1090U, JX1085C, JX1070C/V/U/N, JX1075C/N/V, JX1095V/C/N, JX1100U, JX1080U, JX70U, JX80U, JX55, JX55T, AVJ55, AVJ70, AVJ60, VJ80, JX60, JX80, JX95, JX75, JX65, JX85, JX90U, JX100U, QUANTUM 105F/N/V, QUANTUM 65C/95C/75C/85C, QUANTUM 85F/N/V, 95F/N/V, QUANTUM 95F/N/V, 75F/N/V, VJ70, VJ60, JX95, JX90, JX70, JX90	1966557C1, 4954935, 5122028, 5197980, 87345759, 87541562, B513160	
14882	Cuscinetto pto 110 x 70 x 20 mm / Pto Bearing 110 x 70 x 20 mm		AVJ55-AVJ60-AVJ70, JX100U-JX1070U-JX1080U, JX1090U-JX1100U, JX70U-JX80U-JX90U, VJ60-VJ70-VJ80	24905360	
84025	Kit composto da - Kit consists of: - Meccanismo/Clutch Ref. 5162900 With box Original LUK - Disco Pto/Disc Pto Ref. 5154703 Not Original - Cuscinetto/Bearing Ref. 5122028 Not Original - Cuscinetto/Bearing Ref. 24905360 Not Original	CASE	AVJ55, AVJ60, AVJ70, JX85, JX90, VJ60, VJ70, VJ80	9973691	
07859	Meccanismo Frizione 11" - Luk originale/Clutch 11" - Original Luk		AVJ55, AVJ60, AVJ70, JX85, JX90, VJ60, VJ70, VJ80	47512400, 5162900	

Art./Ref.	Note/Notes	Brand	Applicazione/Application	Rif. Orig./Orig. Ref.	Immagine/Image
<b>26988</b>	Disco Pto Diametro 280 mm - Pto Disc Diameter 280 mm	<b>CASE</b>	JX85,JX90,VJ80	5145715, 5154703	
<b>12841</b>	Cuscinetto reggispinta 90 x 50 x 21,60 mm / Thrust Bearing 90 x 50 x 21,60 mm		2140,2120,2130,2150, FARMALL 75C/55C/65C, JX1060V/C, JX1090U, JX1085C, JX1070C/V/U/N, JX1075C/N/V, JX1095V/C/N, JX1100U, JX1080U, JX70U, JX80U, JX55, JX55T, AVJ55, AVJ70, AVJ60, VJ80, JX60, JX80, JX95, JX75, JX65, JX85, JX90U, JX100U, QUANTUM 105F/N/V, QUANTUM 65C/95C/75C/85C, QUANTUM 85F/N/V, 95F/N/V, QUANTUM 95F/N/V, 75F/N/V, VJ70, VJ60, JX95, JX90, JX70, JX90	1966557C1, 4954935, 5122028, 5197980, 87345759, 87541562, B513160	
<b>14882</b>	Cuscinetto pto 110 x 70 x 20 mm / Pto Bearing 110 x 70 x 20 mm		AVJ55-AVJ60-AVJ70, JX100U-JX1070U-JX1080U, JX1090U-JX1100U, JX70U-JX80U-JX90U, VJ60-VJ70-VJ80	24905360	
<b>LUK628105310</b>	Kit tutto originale LUK composto da - Kit all LUK original consists of: - Meccanismo/Clutch Ref. 228 0098 10 - Disco Pto/Disc Pto 328 0186 16 - Cuscinetto/Bearing Ref. 500 0459 00 - Cuscinetto/Bearing Ref. 500 0284 00 - Cuscinetto/Bearing Ref. 410 0025 00	<b>CASE</b>	AVJ55, AVJ60, AVJ70, JX85, JX90, VJ60, VJ70, VJ80	9973691	    
<b>07859</b>	Meccanismo Frizione 11" - Luk originale/Clutch 11" - Original Luk		AVJ55, AVJ60, AVJ70, JX85, JX90, VJ60, VJ70, VJ80	47512400, 5162900	
<b>07852</b>	Disco Pto Diametro 280 mm Luk originale - Pto Disc Diameter 280 mm Original Luk		JX85,JX90,VJ80	5145715, 5154703	
<b>LUK500045900</b>	Cuscinetto reggispinta 90 x 50 x 21,60 mm / Thrust Bearing 90 x 50 x 21,60 mm		2140,2120,2130,2150, FARMALL 75C/55C/65C, JX1060V/C, JX1090U, JX1085C, JX1070C/V/U/N, JX1075C/N/V, JX1095V/C/N, JX1100U, JX1080U, JX70U, JX80U, JX55, JX55T, AVJ55, AVJ70, AVJ60, VJ80, JX60, JX80, JX95, JX75, JX65, JX85, JX90U, JX100U, QUANTUM 105F/N/V, QUANTUM 65C/95C/75C/85C, QUANTUM 85F/N/V, 95F/N/V, QUANTUM 95F/N/V, 75F/N/V, VJ70, VJ60, JX95, JX90, JX70, JX90	1966557C1, 4954935, 5122028, 5197980, 87345759, 87541562, B513160	
<b>LUK500028400</b>	Cuscinetto pto 110 x 70 x 20 mm / Pto Bearing 110 x 70 x 20 mm		AVJ55-AVJ60-AVJ70, JX100U-JX1070U-JX1080U, JX1090U-JX1100U, JX70U-JX80U-JX90U, VJ60-VJ70-VJ80	24905360	
<b>LUK410002500</b>	Cuscinetto volano 47 x 17 x 14 mm - Bearing 47 x 17 x 14 mm		2140,2120,2130,2150, FARMALL 75C/55C/65C, JX1060V/C, JX1090U, JX1085C, JX1070C/V/U/N, JX1075C/N/V, JX1095V/C/N, JX1100U, JX1080U, JX70U, JX80U, JX55, JX55T, AVJ55, AVJ70, AVJ60, VJ80, JX60, JX80, JX95, JX75, JX65, JX85, JX90U, JX100U, QUANTUM 105F/N/V, QUANTUM 65C/95C/75C/85C, QUANTUM 85F/N/V, 95F/N/V, QUANTUM 95F/N/V, 75F/N/V, VJ70, VJ60, JX95, JX90, JX70, JX90	28043280	

**KIT FRIZIONE LUK ADATTABILE RIF. 87689675 CASE**

KIT EMBRAYAGE LUK ADAPTABLE REF. 87689675 CASE

KIT CLUTCH LUK ADAPTABLE REF. 87689675 CASE

KIT KUPPLUNG LUK PASSEND ZU REF. 87689675 CASE

KIT EMBRAGUE LUK ADAPTABLE REF. 87689675 CASE

Art./Ref.	Note/Notes	Brand	Applicazione/Application	Rif. Orig./Orig. Ref.	Immagine/Image
LUK628308610	Kit tutto originale LUK composto da - Kit all LUK original consists of: - Meccanismo/Clutch Ref. 228 0184 10 - Disco Pto/Disc Pto 328 0332 10 - Cuscinetto/Bearing Ref. 500 0459 00 - Cuscinetto/Bearing Ref. 500 1292 10 - Cuscinetto/Bearing Ref. 410 0025 00		QUANTUM 105 F - N, QUANTUM 85 C, QUANTUM 95 F - N - V	87689675	
29416	Meccanismo Frizione 11" - Luk originale/Clutch 11" - Original Luk		JX 1070C MAXXIMA, JX 1075C MAXXIMA, JX 1075N - 1075V, JX 1085C, JX 1095C - 1095N - 1095V, QUANTUM 105 F - N, QUANTUM 65 C - V, QUANTUM 75 C - F - N - V, QUANTUM 85 C - F - N - V, QUANTUM 95 F - N - V	5181421, 5196813, 87732504, 87732506	
29414	Disco Pto Diametro 280 mm Luk originale - Pto Disc Diameter 280 mm Original Luk	CASE	JX 1070C MAXXIMA, JX 1075C MAXXIMA, JX 1075N - 1075V, JX 1085C, JX 1095C - 1095N - 1095V, QUANTUM 105 F - N, QUANTUM 65 C - V, QUANTUM 75 C - F - N - V, QUANTUM 85 C - F - N - V, QUANTUM 95 F - N - V	47134874, 5176450	
LUK500045900	Cuscinetto reggispinta 90 x 50 x 21,60 mm / Thrust Bearing 90 x 50 x 21,60 mm		2140,2120,2130,2150, FARMALL 75C/55C/65C, JX1060V/C, JX1090U, JX1085C, JX1070C/N/U/N, JX1075C/N/V, JX1095V/C/N, JX1100U, JX1080U, JX70U, JX80U, JX55, JX55T, AVJ55, AVJ70, AVJ60, VJ80, JX60, JX80, JX95, JX75, JX65, JX85, JX90U, JX100U, QUANTUM 105F/N/V, QUANTUM 65C/95C/75C/85C, QUANTUM 85F/N/V, 95F/N/V, QUANTUM 95F/N/V, 75F/N/V, VJ70, VJ60, JX95, JX90, JX70, JX90	1966557C1, 4954935, 5122028, 5197980, 87345759, 87541562, B513160	
LUK500129210	Cuscinetto pto 115 x 75 x 20 mm / Pto Bearing 115 x 75 x 20 mm		1046-1246-946, 1055-1055XL-1255-1255XL, 1056-1056XL-856-856XL, 1455-1455XL-955-955XL, 353-383-423-453-523-553-554, 433-533-633-733-833-933, 624-654-724-734-824-834, 644-744-844-844S-844XL, 743-743XL, 7455-745XL-845-845XL, 956-956SL, D323, JX1060C-JX1060V-JX1070C, JX1070N-JX1070U-JX1070V, JX1075C-JX1075N-JX1075V, JXU95	3142880R91, 5112084, 5167183	
LUK410002500	Cuscinetto volano 47 x 17 x 14 mm - Bearing 47 x 17 x 14 mm		2140,2120,2130,2150, FARMALL 75C/55C/65C, JX1060V/C, JX1090U, JX1085C, JX1070C/N/U/N, JX1075C/N/V, JX1095V/C/N, JX1100U, JX1080U, JX70U, JX80U, JX55, JX55T, AVJ55, AVJ70, AVJ60, VJ80, JX60, JX80, JX95, JX75, JX65, JX85, JX90U, JX100U, QUANTUM 105F/N/V, QUANTUM 65C/95C/75C/85C, QUANTUM 85F/N/V, 95F/N/V, QUANTUM 95F/N/V, 75F/N/V, VJ70, VJ60, JX95, JX90, JX70, JX90	28043280	













**KIT FRIZIONE LUK ADATTABILE RIF. 87689657 CASE**

KIT EMBRAYAGE LUK ADAPTABLE REF. 87689657 CASE

KIT CLUTCH LUK ADAPTABLE REF. 87689657 CASE

KIT KUPPLUNG LUK PASSEND ZU REF. 87689657 CASE

KIT EMBRAGUE LUK ADAPTABLE REF. 87689657 CASE

Art./Ref.	Note/Notes	Brand	Applicazione/Application	Rif. Orig./Orig. Ref.	Immagine/Image
<b>LUK628103410</b>	Kit tutto originale LUK composto da - Kit all LUK original consists of: - Meccanismo/Clutch Ref. 228 0077 17 - Disco Pto/Disc Pto 328 0186 16 - Cuscinetto/Bearing Ref. 500 0459 00 - Cuscinetto/Bearing Ref. 500 0284 00 - Cuscinetto/Bearing Ref. 410 0025 00		JX 55 MAXXIMA, JX 60 MAXXIMA, JX 60 MAXXIMA STRADDLE, JX 65 MAXXIMA, JX 70 MAXXIMA, JX 70 MAXXIMA STRADDLE, JX 80 MAXXIMA, JX 85 MAXXIMA, JX 90 MAXXIMA, JX 90 MAXXIMA STRADDLE	87689657	    
<b>07850</b>	Meccanismo Frizione 11" - Luk originale/Embrayage 11" - Original Luk/Clutch 11" - Original Luk/Kupplung 11" - Luk/Embrague 11" - Original Luk		JX 55 MAXXIMA, JX 60 MAXXIMA, JX 60 MAXXIMA STRADDLE, JX 65 MAXXIMA, JX 70 MAXXIMA, JX 70 MAXXIMA STRADDLE, JX 80 MAXXIMA, JX 85 MAXXIMA, JX 90 MAXXIMA, JX 90 MAXXIMA STRADDLE	47512408, 5154879, 5171137	
<b>07852</b>	Disco Pto Diametro 280 mm Luk originale - Pto Disc Diameter 280 mm Original Luk	<b>CASE</b>	JX 55 MAXXIMA, JX 60 MAXXIMA, JX 60 MAXXIMA STRADDLE, JX 65 MAXXIMA, JX 70 MAXXIMA, JX 70 MAXXIMA STRADDLE, JX 80 MAXXIMA, JX 85 MAXXIMA, JX 90 MAXXIMA, JX 90 MAXXIMA STRADDLE, JX85, JX90, VJ80	5145715, 5154703	
<b>LUK500045900</b>	Cuscinetto reggispinta 90 x 50 x 21,60 mm / Thrust Bearing 90 x 50 x 21,60 mm		2140,2120,2130,2150, FARMALL 75C/55C/65C, JX1060V/C, JX1090U, JX1085C, JX1070C/V/U/N, JX1075C/N/V, JX1095V/C/N, JX1100U, JX1080U, JX70U, JX80U, JX55, JX55T, AVJ55, AVJ70, AVJ60, VJ80, JX60, JX80, JX95, JX75, JX65, JX85, JX90U, JX100U, QUANTUM 105F/N/V, QUANTUM 65C/95C/75C/85C, QUANTUM 85F/N/V, 95F/N/V, QUANTUM 95F/N/V, 75F/N/V, VJ70, VJ60, JX95, JX90, JX70, JX90	1966557C1, 4954935, 5122028, 5197980, 87345759, 87541562, B513160	
<b>LUK500028400</b>	Cuscinetto pto 110 x 70 x 20 mm / Pto Bearing 110 x 70 x 20 mm		AVJ55-AVJ60-AVJ70, JX100U-JX1070U-JX1080U, JX1090U-JX1100U, JX70U-JX80U-JX90U, VJ60-VJ70-VJ80	24905360	
<b>LUK410002500</b>	Cuscinetto volano 47 x 17 x 14 mm - Bearing 47 x 17 x 14 mm		2140,2120,2130,2150, FARMALL 75C/55C/65C, JX 1070U - 1080U - 1090U, JX 70U MAXXIMA, JX 80U MAXXIMA, JX 90U MAXXIMA, JX1060V/C, JX1090U, JX1085C, JX1070C/V/U/N, JX1075C/N/V, JX1095V/C/N, JX1100U, JX1080U, JX70U, JX80U, JX55, JX55T, AVJ55, AVJ70, AVJ60, VJ80, JX60, JX80, JX95, JX75, JX65, JX85, JX90U, JX100U, JXU 75 - 85 - 95 - 105, QUANTUM 105F/N/V, QUANTUM 65C/95C/75C/85C, QUANTUM 85F/N/V, 95F/N/V, QUANTUM 95F/N/V, 75F/N/V, VJ70, VJ60, JX95, JX90, JX70, JX90	28043280	

**KIT FRIZIONE LUK ADATTABILE RIF. 9973687 CASE**

KIT EMBRAYAGE LUK ADAPTABLE REF. 9973687 CASE

KIT CLUTCH LUK ADAPTABLE REF. 9973687 CASE

KIT KUPPLUNG LUK PASSEND ZU REF. 9973687 CASE

KIT EMBRAGUE LUK ADAPTABLE REF. 9973687 CASE

Art./Ref.	Note/Notes	Brand	Applicazione/Application	Rif. Orig./Orig. Ref.	Immagine/Image
LUK631306010	Kit tutto originale LUK composto da - Kit all LUK original consists of: - Meccanismo/Clutch Ref. 231 0105 10 - Disco Pto/Disc Pto 331 0220 10 - Cuscinetto/Bearing Ref. 500 0459 00 - Cuscinetto/Bearing Ref. 500 1292 10 - Cuscinetto/Bearing Ref. 410 0025 00	CASE	JX 1070U - 1080U - 1090U, JX 70U MAXXIMA, JX 80U MAXXIMA, JX 90U MAXXIMA, JXU 75 - 85 - 95 - 105	9973687	
29420	Meccanismo Frizione 12" - Luk Originale/ Clutch 12" - Original Luk		JX 1070U - 1080U - 1090U, JX 70U MAXXIMA, JX 80U MAXXIMA, JX 90U MAXXIMA, JXU 75 - 85 - 95 - 105	5167935, 5179850, 5189875, 87716719	
29421	Disco Pto Diametro 310 mm Luk originale - Pto Disc Diameter 310 mm Original Luk		JX 1070U - 1080U - 1090U, JX 70U MAXXIMA, JX 80U MAXXIMA, JX 90U MAXXIMA, JXU 75 - 85 - 95 - 105	5167937	
LUK500045900	Cuscinetto reggispinta 90 x 50 x 21,60 mm / Thrust Bearing 90 x 50 x 21,60 mm		2140,2120,2130,2150, FARMALL 75C/55C/65C, JX1060V/C, JX1090U, JX1085C, JX1070C/V/U/N, JX1075C/N/V, JX1095V/ C/N, JX1100U, JX1080U, JX70U, JX80U, JX55, JX55T, AVJ55, AVJ70, AVJ60, VJ80, JX60, JX80, JX95, JX75, JX65, JX85, JX90U, JX100U, QUANTUM 105F/N/V, QUANTUM 65C/95C/75C/85C, QUANTUM 85F/N/V, 95F/N/V, QUANTUM 95F/N/ V, 75F/N/V, VJ70, VJ60, JX95, JX90, JX70, JX90	1966557C1, 4954935, 5122028, 5197980, 87345759, 87541562, B513160	
LUK500129210	Cuscinetto pto 115 x 75 x 20 mm / Pto Bearing 115 x 75 x 20 mm		1046-1246-946, 1055-1055XL-1255-1255XL, 1056-1056XL-856-856XL, 1455-1455XL-955-955XL, 353-383-423-453-523-553-554, 433-533- 633-733-833-933, 624-654-724-734-824-834, 644-744-844-844S-844XL, 743-743XL, 745S-745XL- 845-845XL, 956-956SL, D323, JX 1070U - 1080U - 1090U, JX 70U MAXXIMA, JX 80U MAXXIMA, JX 90U MAXXIMA, JX1060C-JX1060V-JX1070C, JX1070N- JX1070U-JX1070V, JX1075C-JX1075N-JX1075V, JXU 75 - 85 - 95 - 105, JXU95	3142880R91, 5112084, 5167183	
LUK410002500	Cuscinetto volano 47 x 17 x 14 mm - Bearing 47 x 17 x 14 mm		2140,2120,2130,2150, FARMALL 75C/55C/65C, JX 1070U - 1080U - 1090U, JX 70U MAXXIMA, JX 80U MAXXIMA, JX 90U MAXXIMA, JX1060V/ C, JX1090U, JX1085C, JX1070C/V/U/N, JX1075C/N/V, JX1095V/C/N, JX1100U, JX1080U, JX70U, JX80U, JX55, JX55T, AVJ55, AVJ70, AVJ60, VJ80, JX60, JX80, JX95, JX75, JX65, JX85, JX90U, JX100U, JXU 75 - 85 - 95 - 105, QUANTUM 105F/N/V, QUANTUM 65C/95C/75C/85C, QUANTUM 85F/N/V, 95F/N/V, QUANTUM 95F/N/V, 75F/N/V, VJ70, VJ60, JX95, JX90, JX70, JX90	28043280	

**KIT FRIZIONE LUK ORIGINALE RIF. 628318112**

KIT EMBRAYAGE LUK ORIGINAL REF. 628318112

KIT CLUTCH ORIGINAL LUK REF. 628318112

KIT KUPPLUNG LUK REF. 628318112

KIT EMBRAGUE LUK ORIGINAL REF. 628318112

Art./Ref.	Note/Notes	Brand	Applicazione/Application	Rif. Orig./Orig. Ref.	Immagine/Image
<b>LUK628318112</b>	Kit tutto originale LUK composto da - Kit all LUK original consists of: - Meccanismo/Clutch Ref. 128 0302 10 - Disco Pto/Disc Pto 328 0332 11 - Cuscinetto/Bearing Ref. 500 1292 10 - Cuscinetto/Bearing Ref. 410 0133 10		JX 1060C MAXXIMA, JX 1060V MAXXIMA, JX 1070C MAXXIMA, JX 1070N - 1070V, JX 1075C MAXXIMA, JX 1075N - 1075V, JX 1085C - 1095C, JX 1095N - 1095V, QUANTUM 105 F-N-V, QUANTUM 65 C-V, QUANTUM 75 F-N-V, QUANTUM 85 C-F-N-V, QUANTUM 95 F-N-V	47134884, 5186548, 5196770, 87732490	   
<b>29865</b>	Meccanismo Frizione 11" - Luk Originale/Clutch 11" - Original Luk		JX 1060C MAXXIMA, JX 1060V MAXXIMA, JX 1070C MAXXIMA, JX 1070N - 1070V, JX 1075C MAXXIMA, JX 1075N - 1075V, JX 1085C - 1095C, JX 1095N - 1095V, QUANTUM 105 F-N-V, QUANTUM 65 C-V, QUANTUM 75 F-N-V, QUANTUM 85 C-F-N-V, QUANTUM 95 F-N-V	47134884, 5186548, 5196770, 87732490	
<b>29414</b>	Disco Pto Diametro 280 mm Luk originale - Pto Disc Diameter 280 mm Original Luk	<b>CASE</b>	JX 1060C MAXXIMA, JX 1060V MAXXIMA, JX 1070C MAXXIMA, JX 1070N - 1070V, JX 1075C MAXXIMA, JX 1075N - 1075V, JX 1085C, JX 1095C - 1095N - 1095V, QUANTUM 105 F - N, QUANTUM 65 C - V, QUANTUM 75 C - F - N - V, QUANTUM 85 C - F - N - V, QUANTUM 95 F - N - V	47134874, 5176450	
<b>LUK500129210</b>	Cuscinetto pto 115 x 75 x 20 mm / Pto Bearing 115 x 75 x 20 mm		1046-1246-946, 1055-1055XL-1255-1255XL, 1056-1056XL-856-856XL, 1455-1455XL-955-955XL, 353-383-423-453-523-553-554, 433-533-633-733-833-933, 624-654-724-734-824-834, 644-744-844-844S-844XL, 743-743XL, 745S-745XL-845-845XL, 956-956SL, D323, JX 1070U - 1080U - 1090U, JX 70U MAXXIMA, JX 80U MAXXIMA, JX 90U MAXXIMA, JX1060C-JX1060V-JX1070C, JX1070N-JX1070U-JX1070V, JX1075C-JX1075N-JX1075V, JXU 75 - 85 - 95 - 105, JXU95	3142880R91, 5112084, 5167183	
<b>LUK410013310</b>	Cuscinetto volano 40 x 17 x 12 mm - Bearing 40 x 17 x 12 mm		JX 1060C MAXXIMA, JX 1060V MAXXIMA, JX 1070C MAXXIMA, JX 1070N - 1070V, JX 1075C MAXXIMA, JX 1075N - 1075V, JX 1085C - 1095C, JX 1095N - 1095V, QUANTUM 105 F-N-V, QUANTUM 65 C-V, QUANTUM 75 F-N-V, QUANTUM 85 C-F-N-V, QUANTUM 95 F-N-V	87729147	

**KIT FRIZIONE LUK ORIGINALE RIF. 631200110**

KIT EMBRAYAGE LUK ORIGINAL REF. 631200110



KIT CLUTCH ORIGINAL LUK REF. 631200110

KIT KUPPLUNG LUK REF. 631200110



KIT EMBRAGUE LUK ORIGINAL REF. 631200110

Art./Ref.	Note/Notes	Brand	Applicazione/Application	Rif. Orig./Orig. Ref.	Immagine/Image
<b>LUK631200110</b>	Kit tutto originale LUK composto da - Kit all LUK original consists of: - Meccanismo/Clutch Ref. 231 0089 10 - Disco Pto/Disc Pto 331 0220 10 - Cuscinetto/Bearing Ref. 500 0459 00 - Cuscinetto/Bearing Ref. 500 1292 10 - Cuscinetto/Bearing Ref. 410 0025 00	<b>CASE</b>	JX 70U MAXXIMA	87689674	
<b>29422</b>	Meccanismo Frizione 12" - Luk Originale/Clutch 12" - Original Luk		JX 70U MAXXIMA	5167933	
<b>29421</b>	Disco Pto Diametro 310 mm Luk originale - Pto Disc Diameter 310 mm Original Luk		JX 1070U - 1080U - 1090U, JX 70U MAXXIMA, JX 80U MAXXIMA, JX 90U MAXXIMA, JXU 75 - 85 - 95 - 105	5167937	
<b>LUK500045900</b>	Cuscinetto reggispinta 90 x 50 x 21,60 mm / Thrust Bearing 90 x 50 x 21,60 mm		2140,2120,2130,2150, FARMALL 75C/55C/65C, JX1060V/C, JX1090U, JX1085C, JX1070C/V/U/N, JX1075C/N/V, JX1095V/C/N, JX1100U, JX1080U, JX70U, JX80U, JX55, JX55T, AVJ55, AVJ70, AVJ60, VJ80, JX60, JX80, JX95, JX75, JX65, JX85, JX90U, JX100U, QUANTUM 105F/N/V, QUANTUM 65C/95C/75C/85C, QUANTUM 85F/N/V, 95F/N/V, QUANTUM 95F/N/V, 75F/N/V, VJ70, VJ60, JX95, JX90, JX70, JX90	1966557C1, 4954935, 5122028, 5197980, 87345759, 87541562, B513160	
<b>LUK500129210</b>	Cuscinetto pto 115 x 75 x 20 mm / Pto Bearing 115 x 75 x 20 mm		1046-1246-946, 1055-1055XL-1255-1255XL, 1056-1056XL-856-856XL, 1455-1455XL-955-955XL, 353-383-423-453-523-553-554, 433-533-633-733-833-933, 624-654-724-734-824-834, 644-744-844-844S-844XL, 743-743XL, 745S-745XL-845-845XL, 956-956SL, D323, JX 1070U - 1080U - 1090U, JX 70U MAXXIMA, JX 80U MAXXIMA, JX 90U MAXXIMA, JX1060C-JX1060V-JX1070C, JX1070N-JX1070U-JX1070V, JX1075C-JX1075N-JX1075V, JXU 75 - 85 - 95 - 105, JXU95	3142880R91, 5112084, 5167183	
<b>LUK410002500</b>	Cuscinetto volano 47 x 17 x 14 mm - Bearing 47 x 17 x 14 mm		2140,2120,2130,2150, FARMALL 75C/55C/65C, JX 1070U - 1080U - 1090U, JX 70U MAXXIMA, JX 80U MAXXIMA, JX 90U MAXXIMA, JX1060V/C, JX1090U, JX1085C, JX1070C/V/U/N, JX1075C/N/V, JX1095V/C/N, JX1100U, JX1080U, JX70U, JX80U, JX55, JX55T, AVJ55, AVJ70, AVJ60, VJ80, JX60, JX80, JX95, JX75, JX65, JX85, JX90U, JX100U, JXU 75 - 85 - 95 - 105, QUANTUM 105F/N/V, QUANTUM 65C/95C/75C/85C, QUANTUM 85F/N/V, 95F/N/V, QUANTUM 95F/N/V, 75F/N/V, VJ70, VJ60, JX95, JX90, JX70, JX90	28043280	



**KIT FRIZIONE LUK ORIGINALE RIF. 131024910+331021910+500124010**
*KIT EMBRAYAGE LUK ORIGINAL REF. 131024910+331021910+500124010*
*KIT CLUTCH ORIGINAL LUK REF. 131024910+331021910+500124010*
*KIT KUPPLUNG LUK REF. 131024910+331021910+500124010*
*KIT EMBRAGUE LUK ORIGINAL REF. 131024910+331021910+500124010*

Art./Ref.	Note/Notes	Brand	Applicazione/Application	Rif. Orig./Orig. Ref.	Immagine/Image
<b>29418</b>	Meccanismo Frizione 12" - Luk originale/Clutch 12" - Original Luk	<b>CASE</b>	JX100U-JX1070U-JX1080U-JX1090U, JX1100U-JX70U-JX80U-JX90U	5189823	
<b>29419</b>	Disco avanzamento Ø 310 mm a 7 pale LUK originale // Clutch Disc Ø 310 mm 7 pairs of pads Original LUK		JX100U-JX1070U-JX1080U-JX1090U, JX1100U-JX70U-JX80U-JX90U	5167936, 5189825	
<b>LUK500124010</b>	Cuscinetto reggispinta completo 110 x 65 x 210 mm / Bearing + carrier assy 110 x 65 x 210 mm		JX100U-JX1070U-JX1080U-JX1090U, JX1100U-JX70U-JX80U-JX90U	5166287	

**KIT FRIZIONE LUK ORIGINALE RIF. MECCANISMO 5177618**
*KIT EMBRAYAGE LUK ORIGINAL REF. 5177618*
*KIT CLUTCH ORIGINAL LUK REF. 5177618*
*KIT KUPPLUNG LUK REF. 5177618*
*KIT EMBRAGUE LUK ORIGINAL REF. 5177618*

Art./Ref.	Note/Notes	Brand	Applicazione/Application	Rif. Orig./Orig. Ref.	Immagine/Image
<b>07877</b>	Meccanismo Frizione 13" - Luk originale/Clutch 13" - Original Luk	<b>CASE</b>	MXM 120 MAXXUM, MXM 130 MAXXUM, MXM 140 MAXXUM	5154418, 5177618	
<b>07878</b>	Disco avanzamento 330 mm a 5 pale Luk originale - Clutch Disc Diameter 330 mm 5 pairs of pads Original Luk		MXM 120 MAXXUM, MXM 130 MAXXUM, MXM 140 MAXXUM	5165650	
<b>LUK500085130</b>	Cuscinetto reggispinta completo 115 x 65 x 30 mm / Bearing + carrier assy 115 x 65 x 30 mm		MXM 120 MAXXUM, MXM 130 MAXXUM, MXM 140 MAXXUM	5149611, 9967339	

**KIT FRIZIONE LUK ORIGINALE RIF. MECCANISMO 5092803**
*KIT EMBRAYAGE LUK ORIGINAL REF. 5092803*
*KIT CLUTCH ORIGINAL LUK REF. 5092803*
*KIT KUPPLUNG LUK REF. 5092803*
*KIT EMBRAGUE LUK ORIGINAL REF. 5092803*

Art./Ref.	Note/Notes	Brand	Applicazione/Application	Rif. Orig./Orig. Ref.	Immagine/Image
<b>VALE0805980</b>	Meccanismo Frizione 12" - Valeo originale/Clutch 12" - Original Valeo/Kupplung 12" - Valeo	<b>CASE</b>	JX 90 MAXXIMA, JX 95 MAXXIMA, JX 95 MAXXIMA STRADDLE	5092803, 84177332	
<b>LUK331032310</b>	Disco Pto Diametro 310 mm Luk originale - Pto Disc Diameter 310 mm Original Luk		JX 90 MAXXIMA, JX 95 MAXXIMA, JX 95 MAXXIMA STRADDLE	5089337, 5092802	
<b>LUK500045900</b>	Cuscinetto reggispinta 90 x 50 x 21,60 mm / Thrust Bearing 90 x 50 x 21,60 mm		2140,2120,2130,2150, FARMALL 75C/55C/65C, JX1060V/C, JX1090U, JX1085C, JX1070C/V/U/N, JX1075C/N/V, JX1095V/C/N, JX1100U, JX1080U, JX70U, JX80U, JX55, JX55T, AVJ55, AVJ70, AVJ60, VJ80, JX60, JX80, JX95, JX75, JX65, JX85, JX90U, JX100U, QUANTUM 105F/N/V, QUANTUM 65C/95C/75C/85C, QUANTUM 85F/N/V, 95F/N/V, QUANTUM 95F/N/V, 75F/N/V, VJ70, VJ60, JX95, JX90, JX70, JX90	1966557C1, 4954935, 5122028, 5197980, 87345759, 87541562, 8513160	

Art./Ref.	Note/Notes	Brand	Applicazione/Application	Rif. Orig./Orig. Ref.	Immagine/Image
LUK500028400	Cuscinetto pto 110 x 70 x 20 mm / Pto Bearing 110 x 70 x 20 mm	CASE	AVJ55-AVJ60-AVJ70, JX100U-JX1070U-JX1080U, JX1090U-JX1100U, JX70U-JX80U-JX90U, VJ60-VJ70-VJ80	24905360	
LUK410002500	Cuscinetto volano 47 x 17 x 14 mm - Bearing 47 x 17 x 14 mm		2140,2120,2130,2150, FARMALL 75C/55C/65C, JX 1070U - 1080U - 1090U, JX 70U MAXXIMA, JX 80U MAXXIMA, JX 90U MAXXIMA, JX1060V/C, JX1090U, JX1085C, JX1070C/V/U/N, JX1075C/N/V, JX1095V/C/N, JX1100U, JX1080U, JX70U, JX80U, JX55, JX55T, AVJ55, AVJ70, AVJ60, VJ80, JX60, JX80, JX95, JX75, JX65, JX85, JX90U, JX100U, JXU 75 - 85 - 95 - 105, QUANTUM 105F/N/V, QUANTUM 65C/95C/75C/85C, QUANTUM 85F/N/V, 95F/N/V, QUANTUM 95F/N/V, 75F/N/V, VJ70, VJ60, JX95, JX90, JX70, JX90	28043280	

**KIT FRIZIONE ADATTABILE RIF. 9973691 FIAT**

KIT EMBRAYAGE ADAPTABLE REF. 9973691 FIAT

KIT CLUTCH ADAPTABLE REF. 9973691 FIAT

KIT KUPPLUNG PASSEND ZU REF. 9973691 FIAT

KIT EMBRAGUE ADAPTABLE REF. 9973691 FIAT

Art./Ref.	Note/Notes	Brand	Applicazione/Application	Rif. Orig./Orig. Ref.	Immagine/Image
57940	Kit composto da - Kit consists of: - Meccanismo/Clutch Ref. 5162900 With box Original CNH - Disco Pto/Disc Pto Ref. 5154703 Not Original - Cuscinetto/Bearing Ref. 5122028 Not Original - Cuscinetto/Bearing Ref. 24905360 Not Original	FIAT	446-466-540S, 55.56, 55.56 DT, 55.66S, 55.66S DT, 570-580-670-680-780, 60.56 DT, 60.66S, 60.66S DT, 60.93, 60.93 DT, 60.94, 60.94 DT, 62.86F, 62.86F DT, 640 SECONDA SERIE, 65.56, 65.56 DT, 65.66S, 65.66S DT, 65.93, 65.93 DT, 65.94, 65.94 DT, 70.56, 70.56 DT, 70.66S, 70.66S DT, 72.86 LP, 72.86 LP DT, 72.86F, 72.86F DT, 72.93, 72.93 DT, 72.94, 72.94 DT, 80.66S, 80.66S DT, 82.86 LP, 82.86F, 82.86F DT, 82.93, 82.93 DT, 82.94, 82.94 DT, 88.93, 88.93 DT, 88.94, 88.94 DT	9973691	
NH5162900	Meccanismo Frizione 11" - Fiat originale/Clutch 11" - Original Fiat		446-466-540S, 55.56, 55.56 DT, 55.66S, 55.66S DT, 570-580-670-680-780, 60.56 DT, 60.66S, 60.66S DT, 60.93, 60.93 DT, 60.94, 60.94 DT, 62.86F, 62.86F DT, 640 SECONDA SERIE, 65.56, 65.56 DT, 65.66S, 65.66S DT, 65.93, 65.93 DT, 65.94, 65.94 DT, 70.56, 70.56 DT, 70.66S, 70.66S DT, 72.86 LP, 72.86 LP DT, 72.86F, 72.86F DT, 72.93, 72.93 DT, 72.94, 72.94 DT, 80.66S, 80.66S DT, 82.86 LP, 82.86F, 82.86F DT, 82.93, 82.93 DT, 82.94, 82.94 DT, 88.93, 88.93 DT, 88.94, 88.94 DT	47512400, 5162900	
26988	Disco Pto Diametro 280 mm - Pto Disc Diameter 280 mm		446 - 446DT, 466 - 466DT, 480 - 480DT, 500 - 500DT, 52.86, 540 - 540DT - 540S, 55-56LM, 55.46, 55.56, 55.56F, 55.66, 55.66LP, 55.88, 55.90, 550, 566, 570, 580, 60-66F, 60-66LP, 60.46, 60.56, 60.66, 60.66S, 60.76, 60.76F, 60.88, 60.90, 60.90LP/F, 60.93, 60.94, 600, 60IIF-70IIF-90IIF, 62.86F, 640, 65-66S, 65-66V, 65.46, 65.56, 65.56F, 65.56L, 65.66, 65.66F, 65.88, 65.90, 65.90L, 65.93, 65.94, 666, 666DT, 670, 670F, 680, 70-66, 70-66F, 70-66LP, 70.56, 70.66, 70.66LP/F, 70.66S, 70.66V, 70.76, 70.76V, 70.88, 70.90, 70.90LP/F, 72.86, 72.86LP, 72.93, 72.94, 780, 80.66, 80.66F, 80.66S, 80.76, 80.88, 80.90, 80/FL, 82.86, 82.86F, 82.86LP, 82.93, 82.93DT, 82.94, 82.94DT, 85.90, 88.93, 88.93DT, 88.94, 88.94DT, 90/LP	5145715, 5154703	
12841	Cuscinetto reggispinta 90 x 50 x 21,60 mm / Thrust Bearing 90 x 50 x 21,60 mm		35-66,35-66DT,45-66,45-66DT, 446,446DT,466,466DT,480,480DT, 50-66,50-66DT,50-66S,55-66, 50-86,50-86V,50-86VDT,60-86F, 500,500DT,540,540DT,540S,550, 55-46,55-46DT,65-46,65-46DT, 55-66DTLP,60-66,60-66DT,65-66, 55-76F,55-76DT,55-76V,55-76VDT, 55-90,55-90DT,60-90,60-90DT, 566,570,580,600,640,666,670, 60-76F,60-76FDT,70-76DT, 60-86FDT,62-86F,70-86V,72-86F, 65-66DT,70-66,70-66DT,70-66F, 65-90,65-90DT,70-90,70-90DT, 680,766,780,880,880-5,980, 70-66LP,70-66V,80-66,80-66DT, 70-76LP,70-76V,80-76DT,80-76F, 70-86VDT,72-86LP,82-86DT, 72-93,72-93DT,82-93,82-93DT, 72-94,72-94DT,82-94,82-94DT, 80-88,80-88DT,100-90,100-90DT, 80-90,80-90DT,85-90,85-90DT, 82-86F,82-86LP,70-88,70-88DT, 88-93,88-93DT,65-94,65-94DT, 88-94,88-94DT,A100SDT,A110, 90-90,90-90DT,65-93,65-93DT, 980DT,L60,L65,L75,L85,L95, A110SDT,A90SDT	4954935, 5122028, 5157318, 5197980, 82824591, 82824592, 87289219, 87345759, 87541561, 87541562, 9976506	

Art./Ref.	Note/Notes	Brand	Applicazione/Application	Rif. Orig./Orig. Ref.	Immagine/Image
14882	Cuscinetto pto 110 x 70 x 20 mm / Pto Bearing 110 x 70 x 20 mm	FIAT	115.90-115.90DT, 130.90-130.90DT, 140.90-140.90DT, 160.90-160.90DT, 180.90-180.90DT, 446-446DT, 466-466DT, 480-480DT, 500-500DT, 540-540DT-540S, 55.46, 55.48, 55.55, 55.56, 55.56LM, 55.60, 55.65, 55.66, 55.66 LP, 55.66LP, 55.70, 55.88, 55.90, 550, 566, 570, 570F, 570V, 580, 60.46, 60.56, 60.66, 60.66F, 60.66LP, 60.66S, 60.76, 60.76F, 60.88, 60.90, 60.90/LPF, 60.93, 60.94, 600, 60IIF,70IIF,80IIF, 62.86, 62.86F, 640, 65.46, 65.56, 65.56L, 65.66, 65.66F, 65.66S, 65.66V, 65.88, 65.90, 65.90L, 65.93, 65.94, 666, 666DT, 670, 670F, 680, 70.56, 70.66, 70.66LP, 70.66LP/F, 70.66S, 70.66V, 70.76, 70.76F, 70.76LP, 70.76V, 70.88, 70.90, 70.90/LPF, 72.86, 72.86LP, 72.93, 72.94, 740, 766, 780, 80.46, 80.56, 80.60, 80.66, 80.66F, 80.66S, 80.70, 80.75, 80.76, 80.85, 80.88, 80.90, 80/FL, 82.86, 82.86LP, 82.93, 82.93DT, 82.94, 82.94DT, 85.90, 88.93, 88.93DT, 88.94, 88.94DT, 880, 90/LP	24905360	
84025	Kit composto da - Kit consists of: - Meccanismo/Clutch Ref. 5162900 With box Original LUK - Disco Pto/Disc Pto Ref. 5154703 Not Original - Cuscinetto/Bearing Ref. 5122028 Not Original - Cuscinetto/Bearing Ref. 24905360 Not Original		446-466-540S, 55.56, 55.56 DT, 55.66S, 55.66S DT, 570-580-670-680-780, 60.56 DT, 60.66S, 60.66S DT, 60.93, 60.93 DT, 60.94, 60.94 DT, 62.86F, 62.86F DT, 640 SECONDA SERIE, 65.56, 65.56 DT, 65.66S, 65.66S DT, 65.93, 65.93 DT, 65.94, 65.94 DT, 70.56, 70.56 DT, 70.66S, 70.66S DT, 72.86 LP, 72.86 LP DT, 72.86F, 72.86F DT, 72.93, 72.93 DT, 72.94, 72.94 DT, 80.66S, 80.66S DT, 82.86 LP, 82.86F, 82.86F DT, 82.93, 82.93 DT, 82.94, 82.94 DT, 88.93, 88.93 DT, 88.94, 88.94 DT	9973691	
07859	Meccanismo Frizione 11" - Luk originale/Clutch 11" - Original Luk		446-466-540S, 55.56, 55.56 DT, 55.66S, 55.66S DT, 570-580-670-680-780, 60.56 DT, 60.66S, 60.66S DT, 60.93, 60.93 DT, 60.94, 60.94 DT, 62.86F, 62.86F DT, 640 SECONDA SERIE, 65.56, 65.56 DT, 65.66S, 65.66S DT, 65.93, 65.93 DT, 65.94, 65.94 DT, 70.56, 70.56 DT, 70.66S, 70.66S DT, 72.86 LP, 72.86 LP DT, 72.86F, 72.86F DT, 72.93, 72.93 DT, 72.94, 72.94 DT, 80.66S, 80.66S DT, 82.86 LP, 82.86F, 82.86F DT, 82.93, 82.93 DT, 82.94, 82.94 DT, 88.93, 88.93 DT, 88.94, 88.94 DT	47512400, 5162900	
26988	Disco Pto Diametro 280 mm - Pto Disc Diameter 280 mm	FIAT	446 - 446DT, 466 - 466DT, 480 - 480DT, 500 - 500DT, 52.86, 540 - 540DT - 540S, 55-56LM, 55.46, 55.56, 55.56F, 55.66, 55.66LP, 55.88, 55.90, 550, 566, 570, 580, 60-66F, 60-66LP, 60.46, 60.56, 60.66, 60.66S, 60.76, 60.76F, 60.88, 60.90, 60.90LP/F, 60.93, 60.94, 600, 60IIF-70IIF-90IIF, 62.86F, 640, 65-66S, 65-66V, 65.46, 65.56, 65.56F, 65.56L, 65.66, 65.66F, 65.88, 65.90, 65.90L, 65.93, 65.94, 666, 666DT, 670, 670F, 680, 70-66, 70-66F, 70-66LP, 70.56, 70.66, 70.66LP/F, 70.66S, 70.66V, 70.76, 70.76V, 70.88, 70.90, 70.90LP/F, 72.86, 72.86LP, 72.93, 72.94, 780, 80.66, 80.66F, 80.66S, 80.76, 80.88, 80.90, 80/FL, 82.86, 82.86F, 82.86LP, 82.93, 82.93DT, 82.94, 82.94DT, 85.90, 88.93, 88.93DT, 88.94, 88.94DT, 90/LP	5145715, 5154703	
12841	Cuscinetto reggispinta 90 x 50 x 21,60 mm / Thrust Bearing 90 x 50 x 21,60 mm		35-66,35-66DT,45-66,45-66DT, 446,446DT,466,466DT,480,480DT, 50-66,50-66DT,50-66S,55-66, 50-86,50-86V,50-86VDT,60-86F, 500,500DT,540,540DT,540S,550, 55-46,55-46DT,65-46,65-46DT, 55-66DTLP,60-66,60-66DT,65-66, 55-76F,55-76DT,55-76V,55-76VDT, 55-90,55-90DT,60-90,60-90DT, 566,570,580,600,640,666,670, 60-76F,60-76FDT,70-76DT, 80-86FDT,62-86F,70-86V,72-86F, 65-66DT,70-66,70-66DT,70-66F, 65-90,65-90DT,70-90,70-90DT, 680,766,780,880,880-5,980, 70-66LP,70-66V,80-66,80-66DT, 70-76LP,70-76V,80-76DT,80-76F, 70-86VDT,72-86LP,82-86DT, 72-93,72-93DT,82-93,82-93DT, 72-94,72-94DT,82-94,82-94DT, 80-88,80-88DT,100-90,100-90DT, 80-90,80-90DT,85-90,85-90DT, 82-86F,82-86LP,70-88,70-88DT, 88-93,88-93DT,65-94,65-94DT, 88-94,88-94DT,A100SDT,A110, 90-90,90-90DT,65-93,65-93DT, 980DT,L60,L65,L75,L85,L95, A110SDT,A90SDT	4954935, 5122028, 5157318, 5197980, 82824591, 82824592, 87289219, 87345759, 87541561, 87541562, 9976506	
14882	Cuscinetto pto 110 x 70 x 20 mm / Pto Bearing 110 x 70 x 20 mm		115.90-115.90DT, 130.90-130.90DT, 140.90-140.90DT, 160.90-160.90DT, 180.90-180.90DT, 446-446DT, 466-466DT, 480-480DT, 500-500DT, 540-540DT-540S, 55.46, 55.48, 55.55, 55.56, 55.56LM, 55.60, 55.65, 55.66, 55.66 LP, 55.66LP, 55.70, 55.88, 55.90, 550, 566, 570, 570F, 570V, 580, 60.46, 60.56, 60.66, 60.66F, 60.66LP, 60.66S, 60.76, 60.76F, 60.88, 60.90, 60.90/LPF, 60.93, 60.94, 600, 60IIF,70IIF,80IIF, 62.86, 62.86F, 640, 65.46, 65.56, 65.56L, 65.66, 65.66F, 65.66S, 65.66V, 65.88, 65.90, 65.90L, 65.93, 65.94, 666, 666DT, 670, 670F, 680, 70.56, 70.66, 70.66LP, 70.66LP/F, 70.66S, 70.66V, 70.76, 70.76F, 70.76LP, 70.76V, 70.88, 70.90, 70.90/LPF, 72.86, 72.86LP, 72.93, 72.94, 740, 766, 780, 80.46, 80.56, 80.60, 80.66, 80.66F, 80.66S, 80.70, 80.75, 80.76, 80.85, 80.88, 80.90, 80/FL, 82.86, 82.86LP, 82.93, 82.93DT, 82.94, 82.94DT, 85.90, 88.93, 88.93DT, 88.94, 88.94DT, 880, 90/LP	24905360	

Art./Ref.	Note/Notes	Brand	Applicazione/Application	Rif. Orig./Orig. Ref.	Immagine/Image
<b>LUK628105310</b>	Kit tutto originale LUK composto da - Kit all LUK original consists of: - Meccanismo/Clutch Ref. 228 0098 10 - Disco Pto/Disc Pto 328 0186 16 - Cuscinetto/Bearing Ref. 500 0459 00 - Cuscinetto/Bearing Ref. 500 0284 00 - Cuscinetto/Bearing Ref. 410 0025 00	<b>FIAT</b>	446-466-540S, 55.56, 55.56 DT, 55.66S, 55.66S DT, 570-580-670-680-780, 60.56 DT, 60.66S, 60.66S DT, 60.93, 60.93 DT, 60.94, 60.94 DT, 62.86F, 62.86F DT, 640 SECONDA SERIE, 65.56, 65.56 DT, 65.66S, 65.66S DT, 65.93, 65.93 DT, 65.94, 65.94 DT, 70.56, 70.56 DT, 70.66S, 70.66S DT, 72.86 LP, 72.86 LP DT, 72.86F, 72.86F DT, 72.93, 72.93 DT, 72.94, 72.94 DT, 80.66S, 80.66S DT, 82.86 LP, 82.86F, 82.86F DT, 82.93, 82.93 DT, 82.94, 82.94 DT, 88.93, 88.93 DT, 88.94, 88.94 DT	9973691	
<b>07859</b>	Meccanismo Frizione 11" - Luk originale/Clutch 11" - Original Luk		446-466-540S, 55.56, 55.56 DT, 55.66S, 55.66S DT, 570-580-670-680-780, 60.56 DT, 60.66S, 60.66S DT, 60.93, 60.93 DT, 60.94, 60.94 DT, 62.86F, 62.86F DT, 640 SECONDA SERIE, 65.56, 65.56 DT, 65.66S, 65.66S DT, 65.93, 65.93 DT, 65.94, 65.94 DT, 70.56, 70.56 DT, 70.66S, 70.66S DT, 72.86 LP, 72.86 LP DT, 72.86F, 72.86F DT, 72.93, 72.93 DT, 72.94, 72.94 DT, 80.66S, 80.66S DT, 82.86 LP, 82.86F, 82.86F DT, 82.93, 82.93 DT, 82.94, 82.94 DT, 88.93, 88.93 DT, 88.94, 88.94 DT	47512400, 5162900	
<b>07852</b>	Disco Pto Diametro 280 mm Luk originale - Pto Disc Diameter 280 mm Original Luk		440,446,450UTB,480,480/8,500S, 55.46,55.56,55.66,55.66LP,, 550,870,570V,570F,580,600,640, 60.66,60.88,60.90,65.88,65.90, 60.66S,60.88,62.86F,65.66, 65.46,65.66,65.56L,70.56,70.66, 65.90,65.93,65.94,70.56,70.66, 670,670F,680,780, 70.66LP/F,70.90,80.66,80.66F, 70.76,72.86,80.76,82.86,80.90, 70.90,85.90,82.93,82.94,88.93, 88.94,55.66,55.88,55.90,60.46	5145715, 5154703	
<b>LUK500045900</b>	Cuscinetto reggispinta 90 x 50 x 21,60 mm / Thrust Bearing 90 x 50 x 21,60 mm		446,446DT,466,466DT,480,480DT, 50-66,50-66DT,50-66S,55-66, 50-86,50-86V,50-86VDT,60-86F, 500,500DT,540,540DT,540S,550, 55-46,55-46DT,65-46,65-46DT, 55-66DTLP,60-66,60-66DT,65-66, 55-76F,55-76DT,55-76V,55-76VDT, 55-90,55-90DT,60-90,60-90DT, 566,570,580,600,640,666,670, 60-76F,60-76FDT,70-76DT, 60-86FDT,62-86F,70-86V,72-86F, 65-66DT,70-66,70-66DT,70-66F, 65-90,65-90DT,70-90,70-90DT, 680,766,780,880,880-5,980, 70-66LP,70-66V,80-66,80-66DT, 70-76LP,70-76V,80-76DT,80-76F, 70-86VDT,72-86LP,82-86DT, 72-93,72-93DT,82-93,82-93DT, 72-94,72-94DT,82-94,82-94DT, 80-88,80-88DT,100-90,100-90DT, 80-90,80-90DT,85-90,85-90DT, 82-86F,82-86LP,70-88,70-88DT, 88-93,88-93DT,65-94,65-94DT, 88-94,88-94DT,A100SDT,A110, 90-90,90-90DT,65-93,65-93DT, 980DT,L60,L65,L75,L85,L95, A110SDT,A90SDT	4954935, 5122028, 5157318, 5197980, 82824591, 82824592, 87289219, 87345759, 87541561, 87541562, 9976506	
<b>LUK500028400</b>	Cuscinetto pto 110 x 70 x 20 mm / Pto Bearing 110 x 70 x 20 mm		115.90-115.90DT, 130.90-130.90DT, 140.90-140.90DT, 160.90-160.90DT, 180.90-180.90DT, 446-446DT, 466-466DT, 480-480DT, 500-500DT, 540-540DT-540S, 55.46, 55.48, 55.55, 55.56, 55.56LM, 55.60, 55.65, 55.66, 55.66 LP, 55.66LP, 55.70, 55.88, 55.90, 550, 566, 570, 570F, 570V, 580, 60.46, 60.56, 60.66, 60.66F, 60.66LP, 60.66S, 60.76, 60.76F, 60.88, 60.90, 60.90LP/F, 60.93, 60.94, 600, 60IIF,70IIF,80IIF, 62.86, 62.86F, 640, 65.46, 65.56, 65.56L, 65.66, 65.66F, 65.66S, 65.66V, 65.88, 65.90, 65.90L, 65.93, 65.94, 666, 666DT, 670, 670F, 680, 70.56, 70.66, 70.66LP, 70.66LP/F, 70.66S, 70.66V, 70.76, 70.76F, 70.76LP, 70.76V, 70.88, 70.90, 70.90LP/F, 72.86, 72.86LP, 72.93, 72.94, 740, 766, 780, 80.46, 80.56, 80.60, 80.66, 80.66F, 80.66S, 80.70, 80.75, 80.76, 80.85, 80.88, 80.90, 80/FL, 82.86, 82.86LP, 82.93, 82.93DT, 82.94, 82.94DT, 85.90, 88.93, 88.93DT, 88.94, 88.94DT, 880, 90/LP	24905360	
<b>LUK410002500</b>	Cuscinetto volano 47 x 17 x 14 mm - Bearing 47 x 17 x 14 mm		35-66,35-66DT,45-66,45-66DT, 446,446DT,466,466DT,480,480DT, 50-66,50-66DT,50-66S,55-66, 50-86,50-86V,50-86VDT,60-86F, 500,500DT,540,540DT,540S,550, 55-46,55-46DT,65-46,65-46DT, 55-66DTLP,60-66,60-66DT,65-66, 55-76F,55-76DT,55-76V,55-76VDT, 55-90,55-90DT,60-90,60-90DT, 566,570,580,600,640,666,670, 60-76F,60-76FDT,70-76DT, 60-86FDT,62-86F,70-86V,72-86F, 65-66DT,70-66,70-66DT,70-66F, 65-90,65-90DT,70-90,70-90DT, 680,766,780,880,880-5,980, 70-66LP,70-66V,80-66,80-66DT, 70-76LP,70-76V,80-76DT,80-76F, 70-86VDT,72-86LP,82-86DT, 72-93,72-93DT,82-93,82-93DT, 72-94,72-94DT,82-94,82-94DT, 80-88,80-88DT,100-90,100-90DT, 80-90,80-90DT,85-90,85-90DT, 82-86F,82-86LP,70-88,70-88DT, 88-93,88-93DT,65-94,65-94DT, 88-94,88-94DT,A100SDT,A110, 90-90,90-90DT,65-93,65-93DT, 980DT,L60,L65,L75,L85,L95, A110SDT,A90SDT	28043280	







Art./Ref.	Note/Notes	Brand	Applicazione/Application	Rif. Orig./Orig. Ref.	Immagine/Image
<b>57941</b>	Kit composto da - Kit consists of: - Meccanismo/Clutch Ref. 5163936 With box Original CNH - Disco Pto/Disc Pto Ref. 5154514 Not Original - Cuscinetto/Bearing Ref. 5122028 Not Original - Cuscinetto/Bearing Ref. 5112084 Not Original	<b>FIAT</b>	100.90, 100.90 DT, 110.90, 110.90 DT, 880.5, 90.90, 90.90 DT, 980, 980DT, A100SDT, A110, A110SDT, A90SDT, SOM880/4	9973696	
<b>NH5163936</b>	Meccanismo Frizione 12" - Fiat originale/Clutch 12" - Original Fiat		100.90, 100.90 DT, 110.90, 110.90 DT, 880.5, 90.90, 90.90 DT, 980, 980DT, A100SDT, A110, A110SDT, A90SDT, SOM880/4	5163936	
<b>26990</b>	Disco Pto Diametro 310 mm - Pto Disc Diameter 310 mm		100.90, 100.90DT, 110.90, 880, 880-5,980,980DT, 880/5, 90.90, 90.90DT, 980, A100SDT, A110, A110SDT, A90SDT	5154514	
<b>12841</b>	Cuscinetto reggispinta 90 x 50 x 21,60 mm / Thrust Bearing 90 x 50 x 21,60 mm		35-66,35-66DT,45-66,45-66DT, 446,446DT,466,466DT,480,480DT, 50-66,50-66DT,50-66S,55-66, 50-86,50-86V,50-86VDT,60-86F, 500,500DT,540,540DT,540S,550, 55-46,55-46DT,65-46,65-46DT, 55-66DTLP,60-66,60-66DT,65-66, 55-76F,55-76DT,55-76V,55-76VDT, 55-90,55-90DT,60-90,60-90DT, 566,570,580,600,640,666,670, 60-76F,60-76FDT,70-76DT, 60-86FDT,62-86F,70-86V,72-86F, 65-66DT,70-66,70-66DT,70-66F, 65-90,65-90DT,70-90,70-90DT, 680,766,780,880,880-5,980, 70-66LP,70-66V,80-66,80-66DT, 70-76LP,70-76V,80-76DT,80-76F, 70-86VDT,72-86LP,82-86DT, 72-93,72-93DT,82-93,82-93DT, 72-94,72-94DT,82-94,82-94DT, 80-88,80-88DT,100-90,100-90DT, 80-90,80-90DT,85-90,85-90DT, 82-86F,82-86LP,70-88,70-88DT, 88-93,88-93DT,65-94,65-94DT, 88-94,88-94DT,A100SDT,A110, 90-90,90-90DT,65-93,65-93DT, 980DT,L60,L65,L75,L85,L95, A110SDT,A90SDT	4954935, 5122028, 5157318, 5197980, 82824591, 82824592, 87289219, 87345759, 87541561, 87541562, 9976506	
<b>15545</b>	Cuscinetto pto 115 x 75 x 20 mm / Pto Bearing 115 x 75 x 20 mm		100.90, 100.90DT, 110.90, 110.90DT, 880, 880-5, 90.90, 90.90DT, 980, 980DT, A100SDT, A110, A110SDT, A90SDT, SOM880/4	47127081, 5112084, 5167183	
<b>84028</b>	Kit composto da - Kit consists of: - Meccanismo/Clutch Ref. 5163936 With box Original LUK - Disco Pto/Disc Pto Ref. 5154514 Not Original - Cuscinetto/Bearing Ref. 5122028 Not Original - Cuscinetto/Bearing Ref. 5112084 Not Original	<b>FIAT</b>	100.90, 100.90 DT, 110.90, 110.90 DT, 880.5, 90.90, 90.90 DT, 980, 980DT, A100SDT, A110, A110SDT, A90SDT, SOM880/4	9973696	
<b>07864</b>	Meccanismo Frizione 12" - Luk Originale/Clutch 12" - Original Luk		100.90, 100.90DT, 110.90, 880, 880-5,980,980DT, 880/5, 90.90, 90.90DT, 980, A100SDT, A110, A110SDT, A90SDT	5163936	
<b>26990</b>	Disco Pto Diametro 310 mm - Pto Disc Diameter 310 mm		100.90, 100.90DT, 110.90, 880, 880-5,980,980DT, 880/5, 90.90, 90.90DT, 980, A100SDT, A110, A110SDT, A90SDT	5154514	

Art./Ref.	Note/Notes	Brand	Applicazione/Application	Rif. Orig./Orig. Ref.	Immagine/Image
12841	Cuscinetto reggispinta 90 x 50 x 21,60 mm / Thrust Bearing 90 x 50 x 21,60 mm	FIAT	35-66,35-66DT,45-66,45-66DT, 446,446DT,466,466DT,480,480DT, 50-66,50-66DT,50-66S,55-66, 50-86,50-86V,50-86VDT,60-86F, 500,500DT,540,540DT,540S,550, 55-46,55-46DT,65-46,65-46DT, 55-66DTLP,60-66,60-66DT,65-66, 55-76F,55-76DT,55-76V,55-76VDT, 55-90,55-90DT,60-90,60-90DT, 566,570,580,600,640,666,670, 60-76F,60-76FDT,70-76DT, 60-86FDT,62-86F,70-86V,72-86F, 65-66DT,70-66,70-66DT,70-66F, 65-90,65-90DT,70-90,70-90DT, 680,766,780,880,880-5,980, 70-66LP,70-66V,80-66,80-66DT, 70-76LP,70-76V,80-76DT,80-76F, 70-86VDT,72-86LP,82-86DT, 72-93,72-93DT,82-93,82-93DT, 72-94,72-94DT,82-94,82-94DT, 80-88,80-88DT,100-90,100-90DT, 80-90,80-90DT,85-90,85-90DT, 82-86F,82-86LP,70-88,70-88DT, 88-93,88-93DT,65-94,65-94DT, 88-94,88-94DT,A100SDT,A110, 90-90,90-90DT,65-93,65-93DT, 980DT,L60,L65,L75,L85,L95, A110SDT,A90SDT	4954935, 5122028, 5157318, 5197980, 82824591, 82824592, 87289219, 87345759, 87541561, 87541562, 9976506	
15545	Cuscinetto pto 115 x 75 x 20 mm / Pto Bearing 115 x 75 x 20 mm		100.90, 100.90DT, 110.90, 110.90DT, 880, 880-5, 90.90, 90.90DT, 980, 980DT, A100SDT, A110, A110SDT, A90SDT, SOM880/4	47127081, 5112084, 5167183	

LUK631106810	Kit tutto originale LUK composto da - Kit all LUK original consists of: - Meccanismo/Clutch Ref. 231 0049 19 - Disco Pto/Disc Pto 331 0132 16 - Cuscinetto/Bearing Ref. 500 0459 00 - Cuscinetto/Bearing Ref. 500 1292 10 - Cuscinetto/Bearing Ref. 410 0026 00	FIAT	100.90, 100.90 DT, 110.90, 110.90 DT, 880.5, 90.90, 90.90 DT, 980, 980DT, A100SDT, A110, A110SDT, A90SDT, SOM880/4	9973696	
07864	Meccanismo Frizione 12" - Luk Originale/Clutch 12" - Original Luk		100.90, 100.90DT, 110.90, 880, 880-5,980,980DT, 880/5, 90.90, 90.90DT, 980, A100SDT, A110, A110SDT, A90SDT	5163936	
07866	Disco Pto Diametro 310 mm Luk originale - Pto Disc Diameter 310 mm Original Luk		100.90, 100.90DT, 110.90, 880, 880-5,980,980DT, 880/5, 90.90, 90.90DT, 980, A100SDT, A110, A110SDT, A90SDT	5154514	
LUK500045900	Cuscinetto reggispinta 90 x 50 x 21,60 mm / Thrust Bearing 90 x 50 x 21,60 mm		35-66,35-66DT,45-66,45-66DT, 446,446DT,466,466DT,480,480DT, 50-66,50-66DT,50-66S,55-66, 50-86,50-86V,50-86VDT,60-86F, 500,500DT,540,540DT,540S,550, 55-46,55-46DT,65-46,65-46DT, 55-66DTLP,60-66,60-66DT,65-66, 55-76F,55-76DT,55-76V,55-76VDT, 55-90,55-90DT,60-90,60-90DT, 566,570,580,600,640,666,670, 60-76F,60-76FDT,70-76DT, 60-86FDT,62-86F,70-86V,72-86F, 65-66DT,70-66,70-66DT,70-66F, 65-90,65-90DT,70-90,70-90DT, 680,766,780,880,880-5,980, 70-66LP,70-66V,80-66,80-66DT, 70-76LP,70-76V,80-76DT,80-76F, 70-86VDT,72-86LP,82-86DT, 72-93,72-93DT,82-93,82-93DT, 72-94,72-94DT,82-94,82-94DT, 80-88,80-88DT,100-90,100-90DT, 80-90,80-90DT,85-90,85-90DT, 82-86F,82-86LP,70-88,70-88DT, 88-93,88-93DT,65-94,65-94DT, 88-94,88-94DT,A100SDT,A110, 90-90,90-90DT,65-93,65-93DT, 980DT,L60,L65,L75,L85,L95, A110SDT,A90SDT	4954935, 5122028, 5157318, 5197980, 82824591, 82824592, 87289219, 87345759, 87541561, 87541562, 9976506	
LUK500129210	Cuscinetto pto 115 x 75 x 20 mm / Pto Bearing 115 x 75 x 20 mm		100.90, 100.90DT, 110.90, 110.90DT, 880, 880-5, 90.90, 90.90DT, 980, 980DT, A100SDT, A110, A110SDT, A90SDT, SOM880/4	47127081, 5112084, 5167183	



**MECCANISMO + DISCO PTO ORIGINALE LUK RIF. 623099109**

MECANISME + DISQUE PTO ORIGINAL LUK 623099109  
 COVER ASSEMBLY + ORIGINAL PTO DISC LUK REF. 623099109  
 GETRIEBE + ZAPFWELLENSCHEIBE LUK 623099109  
 MECANISMO + DISCO PTO ORIGINAL LUK REF. 623099109

Art./Ref.	Note/Notes	Brand	Applicazione/Application	Rif. Orig./Orig. Ref.	Immagine/Image
<b>LUK623099109</b>	Kit tutto originale LUK composto da - Kit all LUK original consists of: - Meccanismo/Clutch Ref. 223 0024 10 - Disco Pto/Disc Pto 323 0307 10	<b>FIAT</b>	35.66	44907615, 44907617	
<b>LUK223002410</b>	Meccanismo Frizione 9" - Luk originale/Clutch 9" - Original Luk		35.66	44907615	
<b>LUK323030710</b>	Disco Pto Diametro 225 mm Luk originale - Pto Disc Diameter 225 mm Original Luk		35.66	44907617	
<b>LUK500045900</b>	Cuscinetto reggispira 90 x 50 x 21,60 mm / Thrust Bearing 90 x 50 x 21,60 mm		35-66,35-66DT,45-66,45-66DT, 446,446DT,466,466DT,480,480DT, 50-66,50-66DT,50-66S,55-66, 50-86,50-86V,50-86VDT,60-86F, 500,500DT,540,540DT,540S,550, 55-46,55-46DT,65-46,65-46DT, 55-66DTLP,60-66,60-66DT,65-66, 55-76F,55-76DT,55-76V,55-76VDT, 55-90,55-90DT,60-90,60-90DT, 566,570,580,600,640,666,670, 60-76F,60-76FDT,70-76DT, 60-86FDT,62-86F,70-86V,72-86F, 65-66DT,70-66,70-66DT,70-66F, 65-90,65-90DT,70-90,70-90DT, 680,766,780,880,880-5,980, 70-66LP,70-66V,80-66,80-66DT, 70-76LP,70-76V,80-76DT,80-76F, 70-86VDT,72-86LP,82-86DT, 72-93,72-93DT,82-93,82-93DT, 72-94,72-94DT,82-94,82-94DT, 80-88,80-88DT,100-90,100-90DT, 80-90,80-90DT,85-90,85-90DT, 82-86F,82-86LP,70-88,70-88DT, 88-93,88-93DT,65-94,65-94DT, 88-94,88-94DT,A100SDT,A110, 90-90,90-90DT,65-93,65-93DT, 980DT,L60,L65,L75,L85,L95, A110SDT,A90SDT	4954935, 5122028, 5157318, 5197980, 82824591, 82824592, 87289219, 87345759, 87541561, 87541562, 9976506	
<b>LUK500067300</b>	Cuscinetto pto 100 x 65 x 18 mm / Pto Bearing 100 x 65 x 18 mm	35.66, 45.66 - 45.66DT, 45.66S - 45.66S DT, 45.76 V, 50.66 - 50.66DT, 50.66S - 50.66S DT, 50.86S V - 50.86S V DT, 50.86V - 50.86V DT, 55.66 V - 55.66 V DT, 55.66F - 55.66F DT, 55.76F - 55.76F DT, 55.76V - 55.76V DT, 55.86F - 55.86F DT, 55.86S V - 55.86S V DT, 55.86V - 55.86V DT	24905350		

**MECCANISMO + DISCO PTO ORIGINALE LUK RIF. 625141909**

MECANISME + DISQUE PTO ORIGINAL LUK 625141909  
 COVER ASSEMBLY + ORIGINAL PTO DISC LUK REF. 625141909  
 GETRIEBE + ZAPFWELLENSCHEIBE LUK 625141909  
 MECANISMO + DISCO PTO ORIGINAL LUK REF. 625141909

Art./Ref.	Note/Notes	Brand	Applicazione/Application	Rif. Orig./Orig. Ref.	Immagine/Image
<b>LUK625141909</b>	Kit tutto originale LUK composto da - Kit all LUK original consists of: - Meccanismo/Clutch Ref. 225 0049 12 - Disco Pto/Disc Pto 325 0118 16	<b>FIAT</b>	45.66 - 45.66DT, 45.66S - 45.66S DT, 45.76 V, 50.66 - 50.66DT, 50.66S - 50.66S DT, 50.86S V - 50.86S V DT, 50.86V - 50.86V DT, 55.66 V - 55.66 V DT, 55.66F - 55.66F DT, 55.76F - 55.76F DT, 55.76V - 55.76V DT, 55.86F - 55.86F DT, 55.86S V - 55.86S V DT, 55.86V - 55.86V DT	5128074, 5139339, 5154513, 5154799, 5171493	
<b>26858</b>	Meccanismo Frizione 10" - Luk Originale/Clutch 10" - Original Luk		45.66 - 45.66DT, 45.66S - 45.66S DT, 45.76 V, 50.66 - 50.66DT, 50.66S - 50.66S DT, 50.86S V - 50.86S V DT, 50.86V - 50.86V DT, 55.66 V - 55.66 V DT, 55.66F - 55.66F DT, 55.76F - 55.76F DT, 55.76V - 55.76V DT, 55.86F - 55.86F DT, 55.86S V - 55.86S V DT, 55.86V - 55.86V DT	5139339, 5154513, 5171493	
<b>27384</b>	Disco Pto Diametro 250 mm Luk originale - Pto Disc Diameter 250 mm Original Luk		45.66 - 45.66DT, 45.66S - 45.66S DT, 45.76V, 50.66 - 50.66DT, 50.66S - 50.66S DT, 50.86S V - 50.86S V DT, 50.86V - 50.86V DT, 55.76F - 55.76F DT, 55.76V - 55.76V DT, 55.86F - 55.86F DT, 55.86S V - 55.86S V DT, 55.86V - 55.86V DT	5128074, 5154799	

Art./Ref.	Note/Notes	Brand	Applicazione/Application	Rif. Orig./Orig. Ref.	Immagine/Image
<b>LUK500045900</b>	Cuscinetto reggispinta 90 x 50 x 21,60 mm / Thrust Bearing 90 x 50 x 21,60 mm	<b>FIAT</b>	35-66,35-66DT,45-66,45-66DT, 446,446DT,466,466DT,480,480DT, 50-66,50-66DT,50-66S,55-66, 50-86,50-86V,50-86VDT,60-86F, 500,500DT,540,540DT,540S,550, 55-46,55-46DT,65-46,65-46DT, 55-66DTLP,60-66,60-66DT,65-66, 55-76F,55-76DT,55-76V,55-76VDT, 55-90,55-90DT,60-90,60-90DT, 566,570,580,600,640,666,670, 60-76F,60-76FDT,70-76DT, 60-86FDT,62-86F,70-86V,72-86F, 65-66DT,70-66,70-66DT,70-66F, 65-90,65-90DT,70-90,70-90DT, 680,766,780,880,880-5,980, 70-66LP,70-66V,80-66,80-66DT, 70-76LP,70-76V,80-76DT,80-76F, 70-86VDT,72-86LP,82-86DT, 72-93,72-93DT,82-93,82-93DT, 72-94,72-94DT,82-94,82-94DT, 80-88,80-88DT,100-90,100-90DT, 80-90,80-90DT,85-90,85-90DT, 82-86F,82-86LP,70-88,70-88DT, 88-93,88-93DT,65-94,65-94DT, 88-94,88-94DT,A100SDT,A110, 90-90,90-90DT,65-93,65-93DT, 980DT,L60,L65,L75,L85,L95, A110SDT,A90SDT	4954935, 5122028, 5157318, 5197980, 82824591, 82824592, 87289219, 87345759, 87541561, 87541562, 9976506	
<b>LUK500067300</b>	Cuscinetto pto 100 x 65 x 18 mm / Pto Bearing 100 x 65 x 18 mm		35.66, 45.66 - 45.66DT, 45.66S - 45.66S DT, 45.76 V, 50.66 - 50.66DT, 50.66S - 50.66S DT, 50.86S V - 50.86S V DT, 50.86V - 50.86V DT, 55.66 V - 55.66 V DT, 55.66F - 55.66F DT, 55.76F - 55.76F DT, 55.76V - 55.76V DT, 55.86F - 55.86F DT, 55.86S V - 55.86S V DT, 55.86V - 55.86V DT	24905350	
<b>LUK410002500</b>	Cuscinetto volano 47 x 17 x 14 mm - Bearing 47 x 17 x 14 mm		35-66,35-66DT,45-66,45-66DT, 446,446DT,466,466DT,480,480DT, 50-66,50-66DT,50-66S,55-66, 50-86,50-86V,50-86VDT,60-86F, 500,500DT,540,540DT,540S,550, 55-46,55-46DT,65-46,65-46DT, 55-66DTLP,60-66,60-66DT,65-66, 55-76F,55-76DT,55-76V,55-76VDT, 55-90,55-90DT,60-90,60-90DT, 566,570,580,600,640,666,670, 60-76F,60-76FDT,70-76DT, 60-86FDT,62-86F,70-86V,72-86F, 65-66DT,70-66,70-66DT,70-66F, 65-90,65-90DT,70-90,70-90DT, 680,766,780,880,880-5,980, 70-66LP,70-66V,80-66,80-66DT, 70-76LP,70-76V,80-76DT,80-76F, 70-86VDT,72-86LP,82-86DT, 72-93,72-93DT,82-93,82-93DT, 72-94,72-94DT,82-94,82-94DT, 80-88,80-88DT,100-90,100-90DT, 80-90,80-90DT,85-90,85-90DT, 82-86F,82-86LP,70-88,70-88DT, 88-93,88-93DT,65-94,65-94DT, 88-94,88-94DT,A100SDT,A110, 90-90,90-90DT,65-93,65-93DT, 980DT,L60,L65,L75,L85,L95, A110SDT,A90SDT	28043280	

**MECCANISMO + DISCO AVANZAMENTO ORIGINALE LUK RIF. 635068609**

MECANISME + DISQUE AVANCEMENT ORIGINAL LUK 635068609

COVER ASSEMBLY + ORIGINAL MAIN DRIVE LUK REF. 635068609

GETRIEBE + VORSCHLEIBE LUK 635068609

MECANISMO + DISCO DE AVANCE ORIGINAL LUK REF. 635068609

Art./Ref.	Note/Notes	Brand	Applicazione/Application	Rif. Orig./Orig. Ref.	Immagine/Image
<b>LUK635068609</b>	Kit tutto originale LUK composto da - Kit all LUK original consists of: - Meccanismo/Clutch Ref. 135 0215 10 - Disco Avanzamento/Clutch Disc 335 0129 10	<b>FIAT</b>	F130 - F130DT, F140 - F140DT	5150079, 5165648, 5177620	
<b>16915</b>	Meccanismo Frizione 14" - Luk originale/Clutch 14" - Original Luk		F130 - F130DT, F140 - F140DT	5150079, 5177620	
<b>07880</b>	Disco avanzamento 350 mm a 6 pale Luk originale - Clutch Disc Diameter 350 mm 6 pairs of pads Original Luk		F130 - F130DT, F140 - F140DT	5165648	
<b>LUK500085130</b>	Cuscinetto reggispinta completo 115 x 65 x 30 mm / Bearing + carrier assy 115 x 65 x 30 mm		F130 - F130DT, F140 - F140DT	5149611, 9967339	



**MECCANISMO + DISCO AVANZAMENTO ORIGINALE LUK RIF. 635114309**

MECANISME + DISQUE AVANCEMENT ORIGINAL LUK 635114309

COVER ASSEMBLY + ORIGINAL MAIN DRIVE LUK REF. 635114309

GETRIEBE + VORSCHLEIBE LUK 635114309

MECANISMO + DISCO DE AVANCE ORIGINAL LUK REF. 635114309

Art./Ref.	Note/Notes	Brand	Applicazione/Application	Rif. Orig./Orig. Ref.	Immagine/Image
<b>LUK635114309</b>	Kit tutto originale LUK composto da - Kit all LUK original consists of: - Meccanismo/Clutch Ref. 135 0215 10 - Disco Avanzamento/Clutch Disc 335 0006 10/	<b>FIAT</b>	115.90-115.90DT, 1180-1180DT, 1280-1280DT, 130.90-130.90DT, 1380-1380DT, 140.90-140.90DT, 1580-1580DT, 1880-1880DT, A140 - A140DT	5112400, 5112564, 5112843, 5113135, 5118453, 5123061, 5123062, 5124031	
<b>07873</b>	Meccanismo Frizione 14" - Luk originale/Clutch 14" - Original Luk/		115.90-115.90DT, 1180-1180DT, 1280-1280DT, 130.90-130.90DT, 1380-1380DT, 140.90-140.90DT, 1580-1580DT, 1880-1880DT, A140 - A140DT	5112400, 5112564, 5112843, 5113135, 5123061, 5123062, 5124031	
<b>07874</b>	Disco avanzamento 350 mm a 8 pale Luk originale - Clutch Disc Diameter 350 mm 8 pairs of pads Original Luk		115.90-115.90DT, 1180-1180DT, 1280-1280DT, 130.90-130.90DT, 1380-1380DT, 140.90-140.90DT, 1580-1580DT, 1880-1880DT, A140 - A140DT	5118453	

**KIT FRIZIONE LUK ADATTABILE RIF. 87689658 FIAT**

KIT EMBRAYAGE LUK ADAPTABLE REF. 87689658 FIAT

KIT CLUTCH LUK ADAPTABLE REF. 87689658 FIAT

KIT KUPPLUNG LUK PASSEND ZU REF. 87689658 FIAT

KIT EMBRAGUE LUK ADAPTABLE REF. 87689658 FIAT

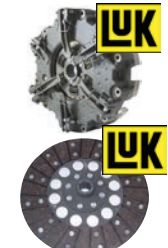
Art./Ref.	Note/Notes	Brand	Applicazione/Application	Rif. Orig./Orig. Ref.	Immagine/Image
<b>LUK628105210</b>	Kit tutto originale LUK composto da - Kit all LUK original consists of: - Meccanismo/Clutch Ref. 228 0093 11 - Disco Pto/Disc Pto 328 0253 10 - Cuscinetto/Bearing Ref. 500 0459 00 - Cuscinetto/Bearing Ref. 500 0673 00 - Cuscinetto/Bearing Ref. 410 0025 00	<b>FIAT</b>	50.86S - 50.86V, 56.66S - 56.66S DT, 60.86F - 60.86F DT, 60.86S - 60.86S DT, 60.86V - 60.86V DT, 70.86S V - 70.86S V DT, 70.86V - 70.86V DT	87689658	
<b>LUK628105209</b>	Kit tutto originale LUK composto da - Kit all LUK original consists of: - Meccanismo/Clutch Ref. 228 0093 11 - Disco Pto/Disc Pto 328 0253 10		50.86S - 50.86V, 56.66S - 56.66S DT, 60.86F - 60.86F DT, 60.86S - 60.86S DT, 60.86V - 60.86V DT, 70.86S V - 70.86S V DT, 70.86V - 70.86V DT	44909044, 47512407, 5171494	

Art./Ref.	Note/Notes	Brand	Applicazione/Application	Rif. Orig./Orig. Ref.	Immagine/Image
<b>LUK500045900</b>	Cuscinetto reggispinta 90 x 50 x 21,60 mm / Thrust Bearing 90 x 50 x 21,60 mm	<b>FIAT</b>	35-66,35-66DT,45-66,45-66DT, 446,446DT,466,466DT,480,480DT, 50-66,50-66DT,50-66S,55-66, 50-86,50-86V,50-86VDT,60-86F, 500,500DT,540,540DT,540S,550, 55-46,55-46DT,65-46,65-46DT, 55-66DTLP,60-66,60-66DT,65-66, 55-76F,55-76DT,55-76V,55-76VDT, 55-90,55-90DT,60-90,60-90DT, 566,570,580,600,640,666,670, 60-76F,60-76FDT,70-76DT, 60-86FDT,62-86F,70-86V,72-86F, 65-66DT,70-66,70-66DT,70-66F, 65-90,65-90DT,70-90,70-90DT, 680,766,780,880,880-5,980, 70-66LP,70-66V,80-66,80-66DT, 70-76LP,70-76V,80-76DT,80-76F, 70-86VDT,72-86LP,82-86DT, 72-93,72-93DT,82-93,82-93DT, 72-94,72-94DT,82-94,82-94DT, 80-88,80-88DT,100-90,100-90DT, 80-90,80-90DT,85-90,85-90DT, 82-86F,82-86LP,70-88,70-88DT, 88-93,88-93DT,65-94,65-94DT, 88-94,88-94DT,A100SDT,A110, 90-90,90-90DT,65-93,65-93DT, 980DT,L60,L65,L75,L85,L95, A110SDT,A90SDT	4954935, 5122028, 5157318, 5197980, 82824591, 82824592, 87289219, 87345759, 87541561, 87541562, 9976506	
<b>LUK500067300</b>	Cuscinetto pto 100 x 65 x 18 mm / Pto Bearing 100 x 65 x 18 mm		35.66, 45.66 - 45.66DT, 45.66S - 45.66S DT, 45.76 V, 50.66 - 50.66DT, 50.66S - 50.66S DT, 50.86S V - 50.86S V DT, 50.86V - 50.86V DT, 55.66 V - 55.66 V DT, 55.66F - 55.66F DT, 55.76F - 55.76F DT, 55.76V - 55.76V DT, 55.86F - 55.86F DT, 55.86S V - 55.86S V DT, 55.86V - 55.86V DT	24905350	
<b>LUK410002500</b>	Cuscinetto volano 47 x 17 x 14 mm - Bearing 47 x 17 x 14 mm		35-66,35-66DT,45-66,45-66DT, 446,446DT,466,466DT,480,480DT, 50-66,50-66DT,50-66S,55-66, 50-86,50-86V,50-86VDT,60-86F, 500,500DT,540,540DT,540S,550, 55-46,55-46DT,65-46,65-46DT, 55-66DTLP,60-66,60-66DT,65-66, 55-76F,55-76DT,55-76V,55-76VDT, 55-90,55-90DT,60-90,60-90DT, 566,570,580,600,640,666,670, 60-76F,60-76FDT,70-76DT, 60-86FDT,62-86F,70-86V,72-86F, 65-66DT,70-66,70-66DT,70-66F, 65-90,65-90DT,70-90,70-90DT, 680,766,780,880,880-5,980, 70-66LP,70-66V,80-66,80-66DT, 70-76LP,70-76V,80-76DT,80-76F, 70-86VDT,72-86LP,82-86DT, 72-93,72-93DT,82-93,82-93DT, 72-94,72-94DT,82-94,82-94DT, 80-88,80-88DT,100-90,100-90DT, 80-90,80-90DT,85-90,85-90DT, 82-86F,82-86LP,70-88,70-88DT, 88-93,88-93DT,65-94,65-94DT, 88-94,88-94DT,A100SDT,A110, 90-90,90-90DT,65-93,65-93DT, 980DT,L60,L65,L75,L85,L95, A110SDT,A90SDT	28043280	

**KIT FRIZIONE LUK ADATTABILE RIF. 87689657 FIAT**

KIT EMBRAYAGE LUK ADAPTABLE REF. 87689657 FIAT

KIT CLUTCH LUK ADAPTABLE REF. 87689657 FIAT

KIT KUPPLUNG LUK PASSEND ZU REF. 87689657 FIAT

KIT EMBRAGUE LUK ADAPTABLE REF. 87689657 FIAT

Art./Ref.	Note/Notes	Brand	Applicazione/Application	Rif. Orig./Orig. Ref.	Immagine/Image
<b>LUK628103410</b>	Kit tutto originale LUK composto da - Kit all LUK original consists of: - Meccanismo/Clutch Ref. 228 0077 17 - Disco Pto/Disc Pto 328 0186 16 - Cuscinetto/Bearing Ref. 500 0459 00 - Cuscinetto/Bearing Ref. 500 0284 00 - Cuscinetto/Bearing Ref. 410 0025 00	<b>FIAT</b>	446 - 450S - 466 - 480, 500 - 530 - 540 - 550, 55.46-55.46 DT, 55.56-55.56 DT, 55.66-55.66 DT, 55.66S-55.66S DT, 55.88-55.88 DT, 55.90-55.90 DT, 566 - 570 - 580 - 600, 60.46-60.46 DT, 60.56-60.56 DT, 60.66-60.66 DT, 60.66S-60.66S DT, 60.76F-60.76F DT, 60.88-60.88 DT, 60.90-60.90 DT, 60.93-60.93 DT, 60.94-60.94 DT, 62.86F-62.86F DT, 640 - 666 - 670 - 680, 65.46-65.46 DT, 65.56-65.56 DT, 65.66S-65.66S DT, 65.88-65.88 DT, 65.90-65.90 DT, 65.93-65.93 DT, 65.94-65.94 DT, 70.56-70.56 DT, 70.66-70.66 DT, 70.66S-70.66S DT, 70.76F-70.76F DT, 70.76LP-70.76LP DT, 70.88-70.88 DT, 70.90-70.90 DT, 72.86F-72.86F DT, 72.86LP-72.86LP DT, 72.93-72.93 DT, 72.94-72.94 DT, 740 - 766 - 780, 80.66F-80.66F DT, 80.66S-80.66S DT, 80.76-80.76 DT, 80.76F-80.76F DT, 80.88-80.88 DT, 80.90-80.90 DT, 82.86F-82.86F DT, 82.86LP-82.86LP DT, 82.93-82.93 DT, 82.94-82.94 DT, 85.90-85.90 DT, 88.93-88.93 DT, 88.94-88.94 DT	87689657	
<b>07850</b>	Meccanismo Frizione 11" - Luk originale/Clutch 11" - Original Luk		446 - 450S - 466 - 480, 500 - 530 - 540 - 550, 55.46-55.46 DT, 55.56-55.56 DT, 55.66-55.66 DT, 55.66S-55.66S DT, 55.88-55.88 DT, 55.90-55.90 DT, 566 - 570 - 580 - 600, 60.46-60.46 DT, 60.56-60.56 DT, 60.66-60.66 DT, 60.66S-60.66S DT, 60.76F-60.76F DT, 60.88-60.88 DT, 60.90-60.90 DT, 60.93-60.93 DT, 60.94-60.94 DT, 62.86F-62.86F DT, 640 - 666 - 670 - 680, 65.46-65.46 DT, 65.56-65.56 DT, 65.66S-65.66S DT, 65.88-65.88 DT, 65.90-65.90 DT, 65.93-65.93 DT, 65.94-65.94 DT, 70.56-70.56 DT, 70.66-70.66 DT, 70.66S-70.66S DT, 70.76F-70.76F DT, 70.76LP-70.76LP DT, 70.88-70.88 DT, 70.90-70.90 DT, 72.86F-72.86F DT, 72.86LP-72.86LP DT, 72.93-72.93 DT, 72.94-72.94 DT, 740 - 766 - 780, 80.66F-80.66F DT, 80.66S-80.66S DT, 80.76-80.76 DT, 80.76F-80.76F DT, 80.88-80.88 DT, 80.90-80.90 DT, 82.86F-82.86F DT, 82.86LP-82.86LP DT, 82.93-82.93 DT, 82.94-82.94 DT, 85.90-85.90 DT, 88.93-88.93 DT, 88.94-88.94 DT	47512408, 5154879, 5171137	

Art./Ref.	Note/Notes	Brand	Applicazione/Application	Rif. Orig./Orig. Ref.	Immagine/Image
<b>07852</b>	Disco Pto Diametro 280 mm Luk originale - Pto Disc Diameter 280 mm Original Luk	<b>FIAT</b>	440,446,450UTB,480,480/8,500S, 55.46,55.56,55.66,55.66LP,, 550,870,570V,570F,580,600,640, 60.66,60.88,60.90,65.88,65.90, 60.66S,60.88,62.86F,65.66, 65.46,65.66,65.56L,70.56,70.66, 65.90,65.93,65.94,70.56,70.66, 670,670F,680,780, 70.66LP/F,70.90,80.66,80.66F, 70.76,72.86,80.76,82.86,80.90, 70.90,85.90,82.93,82.94,88.93, 88.94,55.66,55.88,55.90,60.46	5145715, 5154703	
<b>LUK500045900</b>	Cuscinetto reggispinta 90 x 50 x 21,60 mm / Thrust Bearing 90 x 50 x 21,60 mm		35-66,35-66DT,45-66,45-66DT, 446,446DT,466,466DT,480,480DT, 50-66,50-66DT,50-66S,55-66, 50-86,50-86V,50-86VDT,60-86F, 500,500DT,540,540DT,540S,550, 55-46,55-46DT,65-46,65-46DT, 55-66DTLP,60-66,60-66DT,65-66, 55-76F,55-76DT,55-76V,55-76VDT, 55-90,55-90DT,60-90,60-90DT, 566,570,580,600,640,666,670, 60-76F,60-76FDT,70-76DT, 60-86FDT,62-86F,70-86V,72-86F, 65-66DT,70-66,70-66DT,70-66F, 65-90,65-90DT,70-90,70-90DT, 680,766,780,880,880-5,980, 70-66LP,70-66V,80-66,80-66DT, 70-76LP,70-76V,80-76DT,80-76F, 70-86VDT,72-86LP,82-86DT, 72-93,72-93DT,82-93,82-93DT, 72-94,72-94DT,82-94,82-94DT, 80-88,80-88DT,100-90,100-90DT, 80-90,80-90DT,85-90,85-90DT, 82-86F,82-86LP,70-88,70-88DT, 88-93,88-93DT,65-94,65-94DT, 88-94,88-94DT,A100SDT,A110, 90-90,90-90DT,65-93,65-93DT, 980DT,L60,L65,L75,L85,L95, A110SDT,A90SDT	4954935, 5122028, 5157318, 5197980, 82824591, 82824592, 87289219, 87345759, 87541561, 87541562, 9976506	
<b>LUK500028400</b>	Cuscinetto pto 110 x 70 x 20 mm / Pto Bearing 110 x 70 x 20 mm		115.90-115.90DT, 130.90-130.90DT, 140.90-140.90DT, 160.90-160.90DT, 180.90-180.90DT, 446-446DT, 466-466DT, 480-480DT, 500-500DT, 540-540DT-540S, 55.46, 55.48, 55.55, 55.56, 55.56LM, 55.60, 55.65, 55.66, 55.66 LP, 55.66LP, 55.70, 55.88, 55.90, 550, 566, 570, 570F, 570V, 580, 60.46, 60.56, 60.66, 60.66F, 60.66LP, 60.66S, 60.76, 60.76F, 60.88, 60.90, 60.90/LPF, 60.93, 60.94, 600, 60IIF,70IIF,80IIF, 62.86, 62.86F, 640, 65.46, 65.56, 65.56L, 65.66, 65.66F, 65.66S, 65.66V, 65.88, 65.90, 65.90L, 65.93, 65.94, 666, 666DT, 670, 670F, 680, 70.56, 70.66, 70.66LP, 70.66LP/F, 70.66S, 70.66V, 70.76, 70.76F, 70.76LP, 70.76V, 70.88, 70.90, 70.90/LPF, 72.86, 72.86LP, 72.93, 72.94, 740, 766, 780, 80.46, 80.56, 80.60, 80.66, 80.66F, 80.66S, 80.70, 80.75, 80.76, 80.85, 80.88, 80.90, 80/FL, 82.86, 82.86LP, 82.93, 82.93DT, 82.94, 82.94DT, 85.90, 88.93, 88.93DT, 88.94, 88.94DT, 880, 90/LP	24905360	
<b>LUK410002500</b>	Cuscinetto volano 47 x 17 x 14 mm - Bearing 47 x 17 x 14 mm		35-66,35-66DT,45-66,45-66DT, 446,446DT,466,466DT,480,480DT, 50-66,50-66DT,50-66S,55-66, 50-86,50-86V,50-86VDT,60-86F, 500,500DT,540,540DT,540S,550, 55-46,55-46DT,65-46,65-46DT, 55-66DTLP,60-66,60-66DT,65-66, 55-76F,55-76DT,55-76V,55-76VDT, 55-90,55-90DT,60-90,60-90DT, 566,570,580,600,640,666,670, 60-76F,60-76FDT,70-76DT, 60-86FDT,62-86F,70-86V,72-86F, 65-66DT,70-66,70-66DT,70-66F, 65-90,65-90DT,70-90,70-90DT, 680,766,780,880,880-5,980, 70-66LP,70-66V,80-66,80-66DT, 70-76LP,70-76V,80-76DT,80-76F, 70-86VDT,72-86LP,82-86DT, 72-93,72-93DT,82-93,82-93DT, 72-94,72-94DT,82-94,82-94DT, 80-88,80-88DT,100-90,100-90DT, 80-90,80-90DT,85-90,85-90DT, 82-86F,82-86LP,70-88,70-88DT, 88-93,88-93DT,65-94,65-94DT, 88-94,88-94DT,A100SDT,A110, 90-90,90-90DT,65-93,65-93DT, 980DT,L60,L65,L75,L85,L95, A110SDT,A90SDT	28043280	

**KIT FRIZIONE LUK ORIGINALE RIF. 631107010**

KIT EMBRAYAGE LUK ORIGINAL REF. 631107010

KIT CLUTCH ORIGINAL LUK REF. 631107010

KIT KUPPLUNG LUK REF. 631107010

KIT EMBRAGUE LUK ORIGINAL REF. 631107010

Art./Ref.	Note/Notes	Brand	Applicazione/Application	Rif. Orig./Orig. Ref.	Immagine/Image
<b>LUK631107010</b>	Kit tutto originale LUK composto da - Kit all LUK original consists of: - Meccanismo/Clutch Ref. 231 0050 10 - Disco Pto/Disc Pto 331 0130 16 - Cuscinetto/Bearing Ref. 500 0059 10 - Cuscinetto/Bearing Ref. 500 0058 10 - Cuscinetto/Bearing Ref. 410 0026 00	<b>FIAT</b>	115.90, 115.90DT, 1180, 1180DT	28042740, 44016827, 5113067, 5116210, 5118216, 5120853, 5122097, 5122098, 5144661, 5154551	

Art./Ref.	Note/Notes	Brand	Applicazione/Application	Rif. Orig./Orig. Ref.	Immagine/Image
<b>07870</b>	Meccanismo Frizione 12" - Luk Originale/Clutch 12" - Original Luk	<b>FIAT</b>	115.90, 115.90DT, 1180, 1180DT	5113067, 5116210, 5118216, 5122097, 5122098, 5144661	
<b>07872</b>	Disco Pto Diametro 310 mm Luk originale - Pto Disc Diameter 310 mm Original Luk		115-90,115-90DT, 1180,1180DT	5144662, 5154551	
<b>12846</b>	Cuscinetto reggispinta 97 x 65 x 19 mm / Thrust Bearing 97 x 65 x 19 mm		1000,1000DT, 115-90,115-90DT, 1180,1180DT, 1580,1580DT,1880,1880DT, 160-90,160-90DT,, 180-90,180-90DT, 570N/DT, 670N/DT	5120853	
<b>LUK50005810</b>	Cuscinetto pto 140 x 106 x 21 mm / Pto Bearing 140 x 106 x 21 mm		1000 DT, 1000 SUPER, 115.90, 115.90DT, 1180, 1180DT, 570N/DT, 670N/DT	44016827	

**KIT FRIZIONE LUK ORIGINALE RIF. MECCANISMO 5114526**

KIT EMBRAYAGE LUK ORIGINAL REF. 5114526

KIT CLUTCH ORIGINAL LUK REF. 5114526





KIT KUPPLUNG LUK REF. 5114526

KIT EMBRAGUE LUK ORIGINAL REF. 5114526



Art./Ref.	Note/Notes	Brand	Applicazione/Application	Rif. Orig./Orig. Ref.	Immagine/Image
<b>26859</b>	Meccanismo Frizione 11" - Luk originale/Clutch 11" - Original Luk	<b>FIAT</b>	840, 850, 880 1° TIPO	5104215, 5114526, 5160430	
<b>29412</b>	Disco Pto Diametro 280 mm Luk originale - Pto Disc Diameter 280 mm Original Luk		840, 850, 880 1° TIPO	5102263, 5160410, 9930401	
<b>LUK500045900</b>	Cuscinetto reggispinta 90 x 50 x 21,60 mm / Thrust Bearing 90 x 50 x 21,60 mm		35-66,35-66DT,45-66,45-66DT, 446,446DT,466,466DT,480,480DT, 50-66,50-66DT,50-66S,55-66, 50-86,50-86V,50-86VDT,60-86F, 500,500DT,540,540DT,540S,550, 55-46,55-46DT,65-46,65-46DT, 55-66DTLP,60-66,60-66DT,65-66, 55-76F,55-76DT,55-76V,55-76VDT, 55-90,55-90DT,60-90,60-90DT, 566,570,580,600,640,666,670, 60-76F,60-76FDT,70-76DT, 60-86FDT,62-86F,70-86V,72-86F, 65-66DT,70-66,70-66DT,70-66F, 65-90,65-90DT,70-90,70-90DT, 680,766,780,880,880-5,980, 70-66LP,70-66V,80-66,80-66DT, 70-76LP,70-76V,80-76DT,80-76F, 70-86VDT,72-86LP,82-86DT, 72-93,72-93DT,82-93,82-93DT, 72-94,72-94DT,82-94,82-94DT, 80-88,80-88DT,100-90,100-90DT, 80-90,80-90DT,85-90,85-90DT, 82-86F,82-86LP,70-88,70-88DT, 840, 850, 88-93,88-93DT,65-94,65-94DT, 88-94,88-94DT,A100SDT,A110, 90-90,90-90DT,65-93,65-93DT, 980DT,L60,L65,L75,L85,L95, A110SDT,A90SDT	4954935, 5122028, 5157318, 5197980, 82824591, 82824592, 87289219, 87345759, 87541561, 87541562, 9976506	
<b>LUK500028400</b>	Cuscinetto pto 110 x 70 x 20 mm / Pto Bearing 110 x 70 x 20 mm		115.90-115.90DT, 130.90-130.90DT, 140.90-140.90DT, 160.90-160.90DT, 180.90-180.90DT, 446-446DT, 466-466DT, 480-480DT, 500-500DT, 540-540DT-540S, 55.46, 55.48, 55.55, 55.56, 55.56LM, 55.60, 55.65, 55.66, 55.66 LP, 55.66LP, 55.70, 55.88, 55.90, 550, 566, 570, 570F, 570V, 580, 60.46, 60.56, 60.66, 60.66F, 60.66LP, 60.66S, 60.76, 60.76F, 60.88, 60.90, 60.90/LPF, 60.93, 60.94, 600, 60IIF,70IIF,80IIF, 62.86, 62.86F, 640, 65.46, 65.56, 65.56L, 65.66, 65.66F, 65.66S, 65.66V, 65.88, 65.90, 65.90L, 65.93, 65.94, 666, 666DT, 670, 670F, 680, 70.56, 70.66, 70.66LP, 70.66LP/F, 70.66S, 70.66V, 70.76, 70.76F, 70.76LP, 70.76V, 70.88, 70.90, 70.90/LPF, 72.86, 72.86LP, 72.93, 72.94, 740, 766, 780, 80.46, 80.56, 80.60, 80.66, 80.66F, 80.66S, 80.70, 80.75, 80.76, 80.85, 80.88, 80.90, 80/FL, 82.86, 82.86LP, 82.93, 82.93DT, 82.94, 82.94DT, 840, 85.90, 850, 88.93, 88.93DT, 88.94, 88.94DT, 880, 90/LP	24905360	
<b>LUK410002500</b>	Cuscinetto volano 47 x 17 x 14 mm - Bearing 47 x 17 x 14 mm		35-66,35-66DT,45-66,45-66DT, 446,446DT,466,466DT,480,480DT, 50-66,50-66DT,50-66S,55-66, 50-86,50-86V,50-86VDT,60-86F, 500,500DT,540,540DT,540S,550, 55-46,55-46DT,65-46,65-46DT, 55-66DTLP,60-66,60-66DT,65-66, 55-76F,55-76DT,55-76V,55-76VDT, 55-90,55-90DT,60-90,60-90DT, 566,570,580,600,640,666,670, 60-76F,60-76FDT,70-76DT, 60-86FDT,62-86F,70-86V,72-86F, 65-66DT,70-66,70-66DT,70-66F, 65-90,65-90DT,70-90,70-90DT, 680,766,780,880,880-5,980, 70-66LP,70-66V,80-66,80-66DT, 70-76LP,70-76V,80-76DT,80-76F, 70-86VDT,72-86LP,82-86DT, 72-93,72-93DT,82-93,82-93DT, 72-94,72-94DT,82-94,82-94DT, 80-88,80-88DT,100-90,100-90DT, 80-90,80-90DT,85-90,85-90DT, 82-86F,82-86LP,70-88,70-88DT, 840, 850, 88-93,88-93DT,65-94,65-94DT, 88-94,88-94DT,A100SDT,A110, 90-90,90-90DT,65-93,65-93DT, 980DT,L60,L65,L75,L85,L95, A110SDT,A90SDT	28043280	



**KIT FRIZIONE LUK ORIGINALE RIF. MECCANISMO 5164573 - 5160435**
*KIT EMBRAYAGE LUK ORIGINAL REF. 5164573 - 5160435*
*KIT CLUTCH ORIGINAL LUK REF. 5164573 - 5160435*
*KIT KUPPLUNG LUK REF. 5164573 - 5160435*
*KIT EMBRAGUE LUK ORIGINAL REF. 5164573 - 5160435*

Art./Ref.	Note/Notes	Brand	Applicazione/Application	Rif. Orig./Orig. Ref.	Immagine/Image
<b>07867</b>	Meccanismo Frizione 13" - Luk originale/Clutch 13" - Original Luk	<b>FIAT</b>	1000 DT, 1000 SUPER, 570N/DT, 670N/DT	5160435, 5164573	
<b>07869</b>	Disco Pto Diametro 330 mm Luk originale - Pto Disc Diameter 330 mm Original Luk		1000, 1000 DT, 1000 SUPER, 1000DT, 570N/DT, 670N/DT, 850, 850 DT	5164569, 9924689	
<b>12846</b>	Cuscinetto reggispinta 97 x 65 x 19 mm / Thrust Bearing 97 x 65 x 19 mm		1000, 1000DT, 115-90, 115-90DT, 1180, 1180DT, 1580, 1580DT, 1880, 1880DT, 160-90, 160-90DT, 180-90, 180-90DT, 570N/DT, 670N/DT	5120853	
<b>LUK500005810</b>	Cuscinetto pto 140 x 106 x 21 mm / Pto Bearing 140 x 106 x 21 mm		1000 DT, 1000 SUPER, 115.90, 115.90DT, 1180, 1180DT, 570N/DT, 670N/DT	44016827	

**KIT FRIZIONE LUK ORIGINALE RIF. MECCANISMO 5177618**
*KIT EMBRAYAGE LUK ORIGINAL REF. 5177618*
*KIT CLUTCH ORIGINAL LUK REF. 5177618*
*KIT KUPPLUNG LUK REF. 5177618*
*KIT EMBRAGUE LUK ORIGINAL REF. 5177618*

Art./Ref.	Note/Notes	Brand	Applicazione/Application	Rif. Orig./Orig. Ref.	Immagine/Image
<b>07877</b>	Meccanismo Frizione 13" - Luk originale/Clutch 13" - Original Luk	<b>FIAT</b>	F100 - F100DT, F110 - F110DT, F115 - F115DT, F120 - F120DT	5154418	
<b>07878</b>	Disco avanzamento 330 mm a 5 pale Luk originale - Clutch Disc Diameter 330 mm 5 pairs of pads Original Luk		F100 - F100DT, F110 - F110DT, F115 - F115DT, F120 - F120DT	5154419, 5165650	
<b>LUK500085130</b>	Cuscinetto reggispinta completo 115 x 65 x 30 mm / Bearing + carrier assy 115 x 65 x 30 mm		F100 - F100DT, F110 - F110DT, F115 - F115DT, F120 - F120DT, F130 - F130DT, F140 - F140DT	5149611, 9967339	

**KIT FRIZIONE LUK ORIGINALE RIF. 5140361**
*KIT EMBRAYAGE LUK ORIGINAL REF. 5140361*
*KIT CLUTCH ORIGINAL LUK REF. 5140361*
*KIT KUPPLUNG LUK REF. 5140361*
*KIT EMBRAGUE LUK ORIGINAL REF. 5140361*

Art./Ref.	Note/Notes	Brand	Applicazione/Application	Rif. Orig./Orig. Ref.	Immagine/Image
<b>07875</b>	Kit frizione con meccanismo a 6 leve 12" e disco diametro 310 mm - Luk originale/Kit clutch 6 levels 12" and disc pto diameter 310 mm - Original Luk	<b>FIAT</b>	1580, 1580DT, 160-90DT, 160.90, 180-90DT, 180.90, 1880, 1880DT	5126010, 5128009, 5128010, 5140361	

**KIT FRIZIONI VALEO**

KIT D'EMBAYAGE VALEO  
 CLUTCH KIT VALEO  
 KUPPLUNGSSATZ VALEO  
 KIT DE EMBRAGUE VALEO







Art./Ref.	Note/Notes	Brand	Applicazione/Application	Rif. Orig./Orig. Ref.
12634	Kit frizione originale Valeo diametro 280 mm / Kit clutch Valeo original diameter 280 mm	FIAT	570, 570 DT, 580, 580 DT, 670, 670 DT, 680, 680 DT, 780, 780 DT	1930987
VALEO1930987S	Kit frizione originale Valeo diametro 280 mm / Kit clutch Valeo original diameter 280 mm		550, 550 DT, 600, 600 DT, 640, 640 DT	1930987S
12635	Kit frizione originale Valeo diametro 310 mm / Kit clutch Valeo original diameter 310 mm		100.90, 100.90 DT, 110.90, 110.90 DT, 880, 880 DT, 980, 980 DT	1930988
12636	Kit frizione originale Valeo diametro 310 mm / Kit clutch Valeo original diameter 310 mm		115-90 PTO MECCANICA, 115-90DT PTO MECCANICA, 1180, 1180DT, 1280, 1280DT, 1380, 1380DT	1930989
12637	Kit frizione originale Valeo diametro 310 mm / Kit clutch Valeo original diameter 310 mm		1000, 1000 DT SUPER, 850, 850 DT	1930990
12829	Frizione multidisco pto 5" 1/2 PTO - Clutch multidisc pto 5" 1/2 PTO		115.90 - 115.90DT, 130.90 - 130.90DT, 140.90 - 140.90DT, 160.90 - 160.90DT, 180.90 - 180.90DT, 8430 - 8630 - 8830 TRAT. FORD	5141934, 5141934
12641	Kit frizione originale Valeo - disco avanzamento Ø 280 n°14 cave - Disco PTO Ø 280 n°10 cave			5088629

**KIT FRIZIONE ADATTABILE RIF. 9973691 FORD**

KIT EMBAYAGE ADAPTABLE REF. 9973691 FORD  
 KIT CLUTCH ADAPTABLE REF. 9973691 FORD  
 KIT KUPPLUNG PASSEND ZU REF. 9973691 FORD  
 KIT EMBRAGUE ADAPTABLE REF. 9973691 FORD







Art./Ref.	Note/Notes	Brand	Applicazione/Application	Rif. Orig./Orig. Ref.	Immagine/Image
57940	Kit composto da - Kit consists of: - Meccanismo/Clutch Ref. 5162900 With box Original CNH - Disco Pto/Disc Pto Ref. 5154703 Not Original - Cuscinetto/Bearing Ref. 5122028 Not Original - Cuscinetto/Bearing Ref. 24905360 Not Original	FORD	4030, 4230, 4430	9973691	
NH5162900	Meccanismo Frizione 11" - Fiat originale/ Clutch 11" - Original Fiat		4030, 4230, 4430	47512400, 5162900	

Art./Ref.	Note/Notes	Brand	Applicazione/Application	Rif. Orig./Orig. Ref.	Immagine/Image
<b>26988</b>	Disco Pto Diametro 280 mm - Pto Disc Diameter 280 mm	<b>FORD</b>	4030,4230,4430	5145715, 5154703	
<b>12841</b>	Cuscinetto reggispinta 90 x 50 x 21,60 mm / Thrust Bearing 90 x 50 x 21,60 mm		4635,4835,5635,7635	5122028	
<b>14882</b>	Cuscinetto pto 110 x 70 x 20 mm / Pto Bearing 110 x 70 x 20 mm		3010S-4010S-5010S, 4030,4230,4430	24905360	
<b>84025</b>	Kit composto da - Kit consists of: - Meccanismo/Clutch Ref. 5162900 With box Original LUK - Disco Pto/Disc Pto Ref. 5154703 Not Original - Cuscinetto/Bearing Ref. 5122028 Not Original - Cuscinetto/Bearing Ref. 24905360 Not Original	<b>FORD</b>	4030, 4230, 4430	9973691	   
<b>07859</b>	Meccanismo Frizione 11" - Luk originale/ Clutch 11" - Original Luk		4030, 4230, 4430	47512400, 5162900	
<b>26988</b>	Disco Pto Diametro 280 mm - Pto Disc Diame- ter 280 mm		4030,4230,4430	5145715, 5154703	
<b>12841</b>	Cuscinetto reggispinta 90 x 50 x 21,60 mm / Thrust Bearing 90 x 50 x 21,60 mm		4635,4835,5635,7635	5122028	
<b>14882</b>	Cuscinetto pto 110 x 70 x 20 mm / Pto Bearing 110 x 70 x 20 mm		3010S-4010S-5010S, 4030,4230,4430	24905360	
<b>LUK628105310</b>	Kit tutto originale LUK composto da - Kit all LUK original consists of: - Meccanismo/Clutch Ref. 228 0098 10 - Disco Pto/Disc Pto 328 0186 16 - Cuscinetto/Bearing Ref. 500 0459 00 - Cuscinetto/Bearing Ref. 500 0284 00 - Cuscinetto/Bearing Ref. 410 0025 00		<b>FORD</b>	4030, 4230, 4430	9973691

Art./Ref.	Note/Notes	Brand	Applicazione/Application	Rif. Orig./Orig. Ref.	Immagine/Image
07859	Meccanismo Frizione 11" - Luk originale/ Clutch 11" - Original Luk	FORD	4030, 4230, 4430	47512400, 5162900	
07852	Disco Pto Diametro 280 mm Luk originale - Pto Disc Diameter 280 mm Original Luk		4030,4230,4430	5145715, 5154703	
LUK500045900	Cuscinetto reggispinta 90 x 50 x 21,60 mm / Thrust Bearing 90 x 50 x 21,60 mm		4635,4835,5635,7635	5122028	
LUK500028400	Cuscinetto pto 110 x 70 x 20 mm / Pto Bearing 110 x 70 x 20 mm		3010S-4010S-5010S, 4030,4230,4430	24905360	
LUK410002500	Cuscinetto volano 47 x 17 x 14 mm - Bearing 47 x 17 x 14 mm		4635,4835,5635,7635	28043280	

**MECCANISMO + DISCO PTO ORIGINALE LUK RIF. 625141909**

MECANISME + DISQUE PTO ORIGINAL LUK 625141909  
 COVER ASSEMBLY + ORIGINAL PTO DISC LUK REF. 625141909  
 GETRIEBE + ZAPFWELLENSCHEIBE LUK 625141909  
 MECANISMO + DISCO PTO ORIGINAL LUK REF. 625141909

Art./Ref.	Note/Notes	Brand	Applicazione/Application	Rif. Orig./Orig. Ref.	Immagine/Image
LUK625141909	Kit tutto originale LUK composto da - Kit all LUK original consists of: - Meccanismo/Clutch Ref. 225 0049 12 - Disco Pto/Disc Pto 325 0118 16	FORD	3435 - 3935, 3830	5128074, 5139339, 5154513, 5154799, 5171493	 
26858	Meccanismo Frizione 10" - Luk Originale/ Clutch 10" - Original Luk		3435 - 3935, 3830	5139339, 5154513, 5171493	
27384	Disco Pto Diametro 250 mm Luk originale - Pto Disc Diameter 250 mm Original Luk		3435, 3830, 3935	5128074, 5154799	
LUK500045900	Cuscinetto reggispinta 90 x 50 x 21,60 mm / Thrust Bearing 90 x 50 x 21,60 mm		3435 - 3935, 3830, 4135, 4635,4835,5635,7635	5122028	
LUK500067300	Cuscinetto pto 100 x 65 x 18 mm / Pto Bearing 100 x 65 x 18 mm		3435 - 3935, 3830, 4135	24905350	
LUK410002500	Cuscinetto volano 47 x 17 x 14 mm/Bearing 47 x 17 x 14 mm		3435 - 3935, 3830, 4135, 4635,4835,5635,7635	28043280	





**MECCANISMO + DISCO AVANZAMENTO ORIGINALE LUK RIF. 635068609**

MECANISME + DISQUE AVANCEMENT ORIGINAL LUK 635068609

COVER ASSEMBLY + ORIGINAL MAIN DRIVE LUK REF. 635068609

GETRIEBE + VORSCHLEIBE LUK 635068609

MECANISMO + DISCO DE AVANCE ORIGINAL LUK REF. 635068609

Art./Ref.	Note/Notes	Brand	Applicazione/Application	Rif. Orig./Orig. Ref.	Immagine/Image
<b>LUK635068609</b>	Kit tutto originale LUK composto da - Kit all LUK original consists of: - Meccanismo/Clutch Ref. 135 0215 10 - Disco Avanzamento/Clutch Disc 335 0129 10	<b>FORD</b>	8160 - 8260 - 8360	5150079, 5165648, 5177620	
<b>16915</b>	Meccanismo Frizione 14" - Luk originale/ Clutch 14" - Original Luk		8160 - 8260 - 8360	5150079, 5177620	
<b>07880</b>	Disco avanzamento 350 mm a 6 pale Luk originale - Clutch Disc Diameter 350 mm 6 pairs of pads Original Luk		8160 - 8260 - 8360	5165648	
<b>LUK500085130</b>	Cuscinetto reggispinta completo 115 x 65 x 30 mm / Bearing + carrier assy 115 x 65 x 30 mm		8160 - 8260 - 8360	5149611, 9967339	



**MECCANISMO + DISCO AVANZAMENTO ORIGINALE LUK RIF. 635114309**

MECANISME + DISQUE AVANCEMENT ORIGINAL LUK 635114309

COVER ASSEMBLY + ORIGINAL MAIN DRIVE LUK REF. 635114309

GETRIEBE + VORSCHLEIBE LUK 635114309

MECANISMO + DISCO DE AVANCE ORIGINAL LUK REF. 635114309

Art./Ref.	Note/Notes	Brand	Applicazione/Application	Rif. Orig./Orig. Ref.	Immagine/Image
<b>LUK635114309</b>	Kit tutto originale LUK composto da - Kit all LUK original consists of: - Meccanismo/Clutch Ref. 135 0215 10 - Disco Avanzamento/Clutch Disc 335 0006 10	<b>FORD</b>	8430 - 8630 - 8830	5118453, 5123062	
<b>07873</b>	Meccanismo Frizione 14" - Luk originale/ Clutch 14" - Original Luk		8430 - 8630 - 8830	5123062	
<b>07874</b>	Disco avanzamento 350 mm a 8 pale Luk originale/Clutch Disc Diameter 350 mm 8 pairs of pads Original Luk		8430 - 8630 - 8830	5118453	











## KIT FRIZIONE LUK ADATTABILE RIF. 87689658 FORD

KIT EMBRAYAGE LUK ADAPTABLE REF. 87689658 FORD

KIT CLUTCH LUK ADAPTABLE REF. 87689658 FORD

KIT KUPPLUNG LUK PASSEND ZU REF. 87689658 FORD

KIT EMBRAGUE LUK ADAPTABLE REF. 87689658 FORD

Art./Ref.	Note/Notes	Brand	Applicazione/Application	Rif. Orig./Orig. Ref.	Immagine/Image
LUK628105210	Kit tutto originale LUK composto da - Kit all LUK original consists of: - Meccanismo/Clutch Ref. 228 0093 11 - Disco Pto/Disc Pto 328 0253 10 - Cuscinetto/Bearing Ref. 500 0459 00 - Cuscinetto/Bearing Ref. 500 0673 00 - Cuscinetto/Bearing Ref. 410 0025 00	FORD	4135	87689658	    
LUK628105209	Kit tutto originale LUK composto da - Kit all LUK original consists of: - Meccanismo/Clutch Ref. 228 0093 11 - Disco Pto/Disc Pto 328 0253 10		4135	44909044, 47512407, 5171494	 
LUK500045900	Cuscinetto reggispinta 90 x 50 x 21,60 mm / Thrust Bearing 90 x 50 x 21,60 mm		3435 - 3935, 3830, 4135, 4635, 4835, 5635, 7635, 6635	5122028	
LUK500067300	Cuscinetto pto 100 x 65 x 18 mm / Pto Bearing 100 x 65 x 18 mm		3435 - 3935, 3830, 4135	24905350	
LUK410002500	Cuscinetto volano 47 x 17 x 14 mm/Bearing 47 x 17 x 14 mm		3435 - 3935, 3830, 4135, 4635, 4835, 5635, 7635, 6635	28043280	

**KIT FRIZIONE LUK ADATTABILE RIF. 87689657 FORD**

KIT EMBRAYAGE LUK ADAPTABLE REF. 87689657 FORD

KIT CLUTCH LUK ADAPTABLE REF. 87689657 FORD

KIT KUPPLUNG LUK PASSEND ZU REF. 87689657 FORD

KIT EMBRAGUE LUK ADAPTABLE REF. 87689657 FORD

Art./Ref.	Note/Notes	Brand	Applicazione/Application	Rif. Orig./Orig. Ref.	Immagine/Image
<b>LUK628103410</b>	Kit tutto originale LUK composto da - Kit all LUK original consists of: - Meccanismo/Clutch Ref. 228 0077 17 - Disco Pto/Disc Pto 328 0186 16 - Cuscinetto/Bearing Ref. 500 0459 00 - Cuscinetto/Bearing Ref. 500 0284 00 - Cuscinetto/Bearing Ref. 410 0025 00	<b>FORD</b>	4030-4230-4430	87689657	    
<b>07850</b>	Meccanismo Frizione 11" - Luk originale/ Clutch 11" - Original Luk		4030-4230-4430	47512408, 5154879, 5171137	
<b>07852</b>	Disco Pto Diametro 280 mm Luk originale/ Pto Disc Diameter 280 mm Original Luk		4030,4230,4430	5145715, 5154703	
<b>LUK500045900</b>	Cuscinetto reggispinta 90 x 50 x 21,60 mm / Thrust Bearing 90 x 50 x 21,60 mm		3435 - 3935, 3830, 4135, 4635,4835,5635,7635, 6635	5122028	
<b>LUK500028400</b>	Cuscinetto pto 110 x 70 x 20 mm / Pto Bearing 110 x 70 x 20 mm		3010S-4010S-5010S, 4030,4230,4430	24905360	
<b>LUK410002500</b>	Cuscinetto volano 47 x 17 x 14 mm/ Bearing 47 x 17 x 14 mm		3435 - 3935, 3830, 4135, 4635,4835,5635,7635, 6635	28043280	

**KIT FRIZIONE LUK ADATTABILE RIF. 9973687 FORD**

KIT EMBRAYAGE LUK ADAPTABLE REF. 9973687 FORD

KIT CLUTCH LUK ADAPTABLE REF. 9973687 FORD

KIT KUPPLUNG LUK PASSEND ZU REF. 9973687 FORD

KIT EMBRAGUE LUK ADAPTABLE REF. 9973687 FORD

Art./Ref.	Note/Notes	Brand	Applicazione/Application	Rif. Orig./Orig. Ref.	Immagine/Image
<b>LUK631306010</b>	Kit tutto originale LUK composto da - Kit all LUK original consists of: - Meccanismo/Clutch Ref. 231 0105 10 - Disco Pto/Disc Pto 331 0220 10 - Cuscinetto/Bearing Ref. 500 0459 00 - Cuscinetto/Bearing Ref. 500 1292 10 - Cuscinetto/Bearing Ref. 410 0025 00	<b>FORD</b>	5635, 6635, 7635	9973687	
<b>29420</b>	Meccanismo Frizione 12" - Luk Originale/ Clutch 12" - Original Luk		5635, 6635, 7635	5167935, 5179850, 5189875, 87716719	
<b>29421</b>	Disco Pto Diametro 310 mm Luk originale/Pto Disc Diameter 310 mm Original Luk		5635, 6635, 7635	5167937	
<b>LUK500045900</b>	Cuscinetto reggispinta 90 x 50 x 21,60 mm / Thrust Bearing 90 x 50 x 21,60 mm		3435 - 3935, 3830, 4135, 4635, 4835, 5635, 7635, 6635	5122028	
<b>LUK500129210</b>	Cuscinetto pto 115 x 75 x 20 mm / Pto Bearing 115 x 75 x 20 mm		4635-4835-5635-7635, 6635	5112084, 5167183	
<b>LUK410002500</b>	Cuscinetto volano 47 x 17 x 14 mm/ Bearing 47 x 17 x 14 mm		3435 - 3935, 3830, 4135, 4635, 4835, 5635, 7635, 6635	28043280	













**KIT FRIZIONE LUK ORIGINALE RIF. 631200110**

KIT EMBRAYAGE LUK ORIGINAL REF. 631200110

KIT CLUTCH ORIGINAL LUK REF. 631200110

KIT KUPPLUNG LUK REF. 631200110

KIT EMBRAGUE LUK ORIGINAL REF. 631200110

Art./Ref.	Note/Notes	Brand	Applicazione/Application	Rif. Orig./Orig. Ref.	Immagine/Image
<b>LUK631200110</b>	Kit tutto originale LUK composto da - Kit all LUK original consists of: - Meccanismo/Clutch Ref. 231 0089 10 - Disco Pto/Disc Pto 331 0220 10 - Cuscinetto/Bearing Ref. 500 0459 00 - Cuscinetto/Bearing Ref. 500 1292 10 - Cuscinetto/Bearing Ref. 410 0025 00	<b>FORD</b>	4835, 5635	87689674	    
<b>29422</b>	Meccanismo Frizione 12" - Luk Originale/ Clutch 12" - Original Luk		4835, 5635	5167933	
<b>29421</b>	Disco Pto Diametro 310 mm Luk originale/Pto Disc Diameter 310 mm Original Luk		4835, 5635, 6635, 7635	5167937	
<b>LUK500045900</b>	Cuscinetto reggispinta 90 x 50 x 21,60 mm / Thrust Bearing 90 x 50 x 21,60 mm		3435 - 3935, 3830, 4135, 4635, 4835, 5635, 7635, 6635	5122028	
<b>LUK500129210</b>	Cuscinetto pto 115 x 75 x 20 mm / Pto Bearing 115 x 75 x 20 mm		4635-4835-5635-7635, 6635	5112084, 5167183	
<b>LUK410002500</b>	Cuscinetto volano 47 x 17 x 14 mm/Bearing 47 x 17 x 14 mm		3435 - 3935, 3830, 4135, 4635, 4835, 5635, 7635, 6635	28043280	



**KIT FRIZIONE LUK ORIGINALE RIF. 131024910+331021910+500124010**

KIT EMBRAYAGE LUK ORIGINAL REF. 131024910+331021910+500124010

KIT CLUTCH ORIGINAL LUK REF. 131024910+331021910+500124010

KIT KUPPLUNG LUK REF. 131024910+331021910+500124010

KIT EMBRAGUE LUK ORIGINAL REF. 131024910+331021910+500124010

Art./Ref.	Note/Notes	Brand	Applicazione/Application	Rif. Orig./Orig. Ref.	Immagine/Image
<b>29418</b>	Meccanismo Frizione 12" - Luk originale/ Embrayage 12" - Original Luk/Clutch 12" - Original Luk/Kupplung 12" - Luk/Embrague 12" - Original Luk	<b>FORD</b>	4635-4835-5635-6635-7635, 6630	5167939, 5189823	
<b>29419</b>	Disco avanzamento Ø 310 mm a 7 pale LUK originale / Clutch Disc Ø 310 mm 7 pairs of pads Original LUK		4635,4835,5635,6635,7635, 6630	5179851, 5189825	
<b>LUK500124010</b>	Cuscinetto reggispinta completo 110 x 65 x 210 mm / Bearing + carrier assy 110 x 65 x 210 mm		4635-4835-5635-6635-7635, 6630	5166287	



**KIT FRIZIONE LUK ORIGINALE RIF. MECCANISMO 5177618**

KIT EMBRAYAGE LUK ORIGINAL REF. 5177618

KIT CLUTCH ORIGINAL LUK REF. 5177618

KIT KUPPLUNG LUK REF. 5177618

KIT EMBRAGUE LUK ORIGINAL REF. 5177618

Art./Ref.	Note/Notes	Brand	Applicazione/Application	Rif. Orig./Orig. Ref.	Immagine/Image
<b>07877</b>	Meccanismo Frizione 13" - Luk originale/ Clutch 13" - Original Luk	<b>FORD</b>	8160 - 8260 - 8360	5177618	
<b>07878</b>	Disco avanzamento 330 mm a 5 pale Luk originale - Clutch Disc Diameter 330 mm 5 pairs of pads Original Luk		8160 - 8260 - 8360	5165650	
<b>LUK500085130</b>	Cuscinetto reggispinta completo 115 x 65 x 30 mm / Bearing + carrier assy 115 x 65 x 30 mmassy 115 x 65 x 30 mm		8160 - 8260 - 8360	5149611, 9967339	





**KIT FRIZIONE LUK ADATTABILE RIF. 87689675 NEW HOLLAND**

KIT EMBRAYAGE LUK ADAPTABLE REF. 87689675 NEW HOLLAND

KIT CLUTCH LUK ADAPTABLE REF. 87689675 NEW HOLLAND

KIT KUPPLUNG LUK PASSEND ZU REF. 87689675 NEW HOLLAND

KIT EMBRAGUE LUK ADAPTABLE REF. 87689675 NEW HOLLAND

Art./Ref.	Note/Notes	Brand	Applicazione/Application	Rif. Orig./Orig. Ref.	Immagine/Image
<b>LUK628308610</b>	Kit tutto originale LUK composto da - Kit all LUK original consists of: - Meccanismo/Clutch Ref. 228 0184 10 - Disco Pto/Disc Pto 328 0332 10 - Cuscinetto/Bearing Ref. 500 0459 00 - Cuscinetto/Bearing Ref. 500 1292 10 - Cuscinetto/Bearing Ref. 410 0025 00		T4040, TN85A - TN85DA - TN85SA, TN95A - TN95DA, TN95NA - TN95VA	87689675	    
<b>29416</b>	Meccanismo Frizione 11" - Luk originale/ Clutch 11" - Original Luk		T4020 - T4020V, T4030 - T4030F, T4030 - T4040, T4030N - T4030V, T4040, T4040 - T4040F, T4040N - T4040V, T4050F - T4050N - T4050V, TN65F, TN70F - TN70NA, TN75F, TN75F - TN75FA, TN80F, TN85A - TN85DA, TN85A - TN95A, TN85DA - TN95DA, TN85FA - TN85SA, TN85FA - TN95FA, TN85SA, TN90F, TN95A - TN95DA, TN95F, TN95FA, TN95NA, TN95NA - TN95VA, TN95VA	5181421, 5196813, 87732504, 87732506	
<b>29414</b>	Disco Pto Diametro 280 mm Luk originale/ Pto Disc Diameter 280 mm Original Luk	<b>NEW HOLLAND</b>	T4020 - T4020V, T4030 - T4030F, T4030N - T4030V, T4040, T4040 - T4040F, T4040N - T4040V, T4050F - T4050N - T4050V, TN65F, TN70F - TN70NA, TN75F, TN75F - TN75FA, TN80F, TN85A - TN85DA, TN85FA - TN85SA, TN90F, TN95A - TN95DA, TN95F, TN95FA, TN95NA - TN95VA	47134874, 5176450	
<b>LUK500045900</b>	Cuscinetto reggispinta 90 x 50 x 21,60 mm / Thrust Bearing 90 x 50 x 21,60 mm		TL100, TL80, TL90, TL70A, TL80A, TL90A, TN55, TN65, TN70D, TN60A, TN55S, TN65S, TN70S, TN75S, TN60SA, TN60VA, TN70VA, TN75VA, TN95VA, TN70A, TN75A, TN55D, TN65D, TN60DA, TN70DA, TN75DA, TN70F, TN75F, TN70SA, TN75SA, TN55V, TN65V, TN75V, TN55V, TN65V, TN75V, TN80F, TN95F, TN75FA, TN85FA, TN95FA, TN65N, TN75N, TN70NA	5122028, 82824591, 82824592, 87289219, 87345759, 87541562, 9976506	
<b>LUK500129210</b>	Cuscinetto pto 115 x 75 x 20 mm / Pto Bearing 115 x 75 x 20 mm		L60-L65-L75-L85-L95, T5050 - T5060, TL70A-TL80A-TL90A, TL80 - TL90, TN55D-TN65D-TN70D, TN55S-TN65S-TN70S-TN75S, TN55V-TN65V-TN75V, TN60A-TN70A-TN75A, TN60DA-TN70DA-TN75DA, TN60SA-TN70SA-TN75SA, TN60VA-TN70VA-TN75VA-TN95VA, TN65N-TN75N, TN70F-TN75F-TN80F-TN95F, TN70NA, TN75FA-TN85FA-TN95FA	5112084, 5167183	
<b>LUK410002500</b>	Cuscinetto volano 47 x 17 x 14 mm/Bearing 47 x 17 x 14 mm		T4020 - T4020V, T4030 - T4030F, T4030N - T4030V, T4040, T4040 - T4040F, T4040N - T4040V, T4050F - T4050N - T4050V, TN65F, TN70F - TN70NA, TN75F - TN75FA, TN80F, TN85A - TN85DA, TN85FA - TN85SA, TN90F, TN95A - TN95DA, TN95F, TN95FA, TN95NA - TN95VA	28043280	











**KIT FRIZIONE LUK ADATTABILE RIF. 87689657 NEW HOLLAND**

KIT EMBRAYAGE LUK ADAPTABLE REF. 87689657 NEW HOLLAND

KIT CLUTCH LUK ADAPTABLE REF. 87689657 NEW HOLLAND

KIT KUPPLUNG LUK PASSEND ZU REF. 87689657 NEW HOLLAND

KIT EMBRAGUE LUK ADAPTABLE REF. 87689657 NEW HOLLAND

Art./Ref.	Note/Notes	Brand	Applicazione/Application	Rif. Orig./Orig. Ref.	Immagine/Image
<b>LUK628103410</b>	Kit tutto originale LUK composto da - Kit all LUK original consists of: - Meccanismo/Clutch Ref. 228 0077 17 - Disco Pto/Disc Pto 328 0186 16 - Cuscinetto/Bearing Ref. 500 0459 00 - Cuscinetto/Bearing Ref. 500 0284 00 Cuscinetto/Bearing Ref. 410 0025 00	<b>NEW HOLLAND</b>	TD 55 D, TD 60 D, TD 60 STRADDLE MOUNT, TD 65 B - D, TD 70 D, TD 70 STRADDLE MOUNT, TD 75 D, TD 80 D, TD 80 STRADDLE MOUNT, TD 85 D, TD 90 D, TD 90 STRADDLE MOUNT, TT 65 D	87689657	    
<b>07850</b>	Meccanismo Frizione 11" - Luk originale/ Clutch 11" - Original Luk		TD 55 D, TD 60 D, TD 60 STRADDLE MOUNT, TD 65 B - D, TD 70 D, TD 70 STRADDLE MOUNT, TD 75 D, TD 80 D, TD 80 STRADDLE MOUNT, TD 85 D, TD 90 D, TD 90 STRADDLE MOUNT, TT 65 D	47512408, 5154879, 5171137	
<b>07852</b>	Disco Pto Diametro 280 mm Luk originale/Pto Disc Diameter 280 mm Original Luk		TD 55 D, TD 60 D, TD 60 STRADDLE MOUNT, TD 65 B - D, TD 70 D, TD 70 STRADDLE MOUNT, TD 75 D, TD 80 D, TD 80 STRADDLE MOUNT, TD 85 D, TD 90 D, TD 90 STRADDLE MOUNT, TD4020F - TD4030F - TD4040F, TD5.75 - TD5.80, TD5.85 - TD5.90, TD5010 - TD5020 - TD5030, TD85D, TD90D, TK4030, TK80.66 DT, TT 65 D	5145715, 5154703	
<b>LUK500045900</b>	Cuscinetto reggispinta 90 x 50 x 21,60 mm / Thrust Bearing 90 x 50 x 21,60 mm		TL100, TL80, TL90, TL70A, TL80A, TL90A, TN55, TN65, TN70D, TN60A, TN55S, TN65S, TN70S, TN75S, TN60SA, TN60VA, TN70VA, TN75VA, TN95VA, TN70A, TN75A, TN55D, TN65D, TN60DA, TN70DA, TN75DA, TN70F, TN75F, TN70SA, TN75SA, TN55V, TN65V, TN75V, TN55V, TN65V, TN75V, TN80F, TN95F, TN75FA, TN85FA, TN95FA, TN65N, TN75N, TN70NA	5122028, 82824591, 82824592, 87289219, 87345759, 87541562, 9976506	
<b>LUK500028400</b>	Cuscinetto pto 110 x 70 x 20 mm / Pto Bearing 110 x 70 x 20 mm		T7030-T7040-T7050-T7060-T7070, TD4020F-TD4030F-TD4040F, TD5.100-TD5.105, TD5.110-TD5.115, TD5.65-TD5.75-TD5.80, TD5.85. TD5.90-TD5.95, TD5010-TD5020-TD5030, TD5040-TD5050, TD60-TD70-TD80-TD90-TD95, TD60D-TD70D-TD80D-TD90D-TD95D, TD65B, TD65F-TD75F-TD85F, TD85D, TD90D, TK4030, TK80.66DT, TT50-TT55-TT65-TT65D-TT75	24905360	
<b>LUK410002500</b>	Cuscinetto volano 47 x 17 x 14 mm/Bearing 47 x 17 x 14 mm		L65 - L75 - L85 - L95, T4.75 - T4.85, T4.95 - T4.105, T4020 - T4020V, T4030 - T4030F, T4030N - T4030V, T4040, T4040 - T4040F, T4040N - T4040V, T4050F - T4050N - T4050V, T5030 - T5040, T5050 - T5060, TD 55 D, TD 60 D, TD 60 STRADDLE MOUNT, TD 65 B - D, TD 70 D, TD 70 STRADDLE MOUNT, TD 75 D, TD 80 D, TD 80 STRADDLE MOUNT, TD 85 D, TD 90 D, TD 90 STRADDLE MOUNT, TD5040 - TD5050, TL70 - TL75, TL70A - TL80A - TL90A - TL100A, TL75E - TL85E - TL95E, TL80 - TL85, TL90 - TL95 - TL100, TN65F, TN70F - TN70NA, TN75F - TN75FA, TN80F, TN85A - TN85DA, TN85FA - TN85SA, TN90F, TN95A - TN95DA, TN95F, TN95FA, TN95NA - TN95VA, TT 65 D	28043280	





**KIT FRIZIONE LUK ADATTABILE RIF. 9973687 NEW HOLLAND**

KIT EMBRAYAGE LUK ADAPTABLE REF. 9973687 NEW HOLLAND

KIT CLUTCH LUK ADAPTABLE REF. 9973687 NEW HOLLAND

KIT KUPPLUNG LUK PASSEND ZU REF. 9973687 NEW HOLLAND

KIT EMBRAGUE LUK ADAPTABLE REF. 9973687 NEW HOLLAND

Art./Ref.	Note/Notes	Brand	Applicazione/Application	Rif. Orig./Orig. Ref.	Immagine/Image
<b>LUK631306010</b>	Kit tutto originale LUK composto da - Kit all LUK original consists of: - Meccanismo/Clutch Ref. 231 0105 10 - Disco Pto/Disc Pto 331 0220 10 - Cuscinetto/Bearing Ref. 500 0459 00 - Cuscinetto/Bearing Ref. 500 1292 10 - Cuscinetto/Bearing Ref. 410 0025 00		L65 - L75 - L85 - L95, T4.75 - T4.85, T4.95 - T4.105, T5030 - T5040, T5050 - T5060, TD5040 - TD5050, TL70 - TL75, TL70A - TL80A - TL90A - TL100A, TL75E - TL85E - TL95E, TL80 - TL85, TL90 - TL95 - TL100	9973687	    
<b>29420</b>	Meccanismo Frizione 12" - Luk Originale/ Clutch 12" - Original Luk		L65 - L75 - L85 - L95, T4.75 - T4.85, T4.95 - T4.105, T5030 - T5040, T5050 - T5060, TD5040 - TD5050, TL70 - TL75, TL70A - TL80A - TL90A - TL100A, TL75E - TL85E - TL95E, TL80 - TL85, TL90 - TL95 - TL100	5167935, 5179850, 5189875, 87716719	
<b>29421</b>	Disco Pto Diametro 310 mm Luk originale/ Pto Disc Diameter 310 mm Original Luk	<b>NEW HOLLAND</b>	L65 - L75 - L85 - L95, T4.75 - T4.85, T4.95 - T4.105, T5030 - T5040, T5050 - T5060, TD5040 - TD5050, TL70 - TL75, TL70A - TL80A - TL90A - TL100A, TL75E - TL85E - TL95E, TL80 - TL85, TL90 - TL95 - TL100	5167937	
<b>LUK500045900</b>	Cuscinetto reggispinta 90 x 50 x 21,60 mm / Thrust Bearing 90 x 50 x 21,60 mm		TL100, TL80, TL90, TL70A, TL80A, TL90A, TN55, TN65, TN70D, TN60A, TN55S, TN65S, TN70S, TN75S, TN60SA, TN60VA, TN70VA, TN75VA, TN95VA, TN70A, TN75A, TN55D, TN65D, TN60DA, TN70DA, TN75DA, TN70F, TN75F, TN70SA, TN75SA, TN55V, TN65V, TN75V, TN55V, TN65V, TN75V, TN80F, TN95F, TN75FA, TN85FA, TN95FA, TN65N, TN75N, TN70NA	5122028, 82824591, 82824592, 87289219, 87345759, 87541562, 9976506	
<b>LUK500129210</b>	Cuscinetto pto 115 x 75 x 20 mm / Pto Bearing 115 x 75 x 20 mm		L60-L65-L75-L85-L95, T5050 - T5060, TL70A-TL80A-TL90A, TL80 - TL90, TN55D-TN65D-TN70D, TN55S-TN65S-TN70S-TN75S, TN55V-TN65V-TN75V, TN60A-TN70A-TN75A, TN60DA-TN70DA-TN75DA, TN60SA-TN70SA-TN75SA, TN60VA-TN70VA-TN75VA-TN95VA, TN65N-TN75N, TN70F-TN75F-TN80F-TN95F, TN70NA, TN75FA-TN85FA-TN95FA	5112084, 5167183	
<b>LUK410002500</b>	Cuscinetto volano 47 x 17 x 14 mm/Bearing 47 x 17 x 14 mm		L65 - L75 - L85 - L95, T4.75 - T4.85, T4.95 - T4.105, T4020 - T4020V, T4030 - T4030F, T4030N - T4030V, T4040, T4040F, T4040N - T4040V, T4050F - T4050N - T4050V, T5030 - T5040, T5050 - T5060, TD 55 D, TD 60 D, TD 60 STRADDLE MOUNT, TD 65 B - D, TD 70 D, TD 70 STRADDLE MOUNT, TD 75 D, TD 80 D, TD 80 STRADDLE MOUNT, TD 85 D, TD 90 D, TD 90 STRADDLE MOUNT, TD5040 - TD5050, TL70 - TL75, TL70A - TL80A - TL90A - TL100A, TL75E - TL85E - TL95E, TL80 - TL85, TL90 - TL95 - TL100, TN65F, TN70F - TN70NA, TN75F - TN75FA, TN80F, TN85A - TN85DA, TN85FA - TN85SA, TN90F, TN95A - TN95DA, TN95F, TN95FA, TN95NA - TN95VA, TT 65 D	28043280	

**KIT FRIZIONE LUK ADATTABILE RIF. 73328271 NEW HOLLAND**

KIT EMBRAYAGE LUK ADAPTABLE REF. 73328271 NEW HOLLAND

KIT CLUTCH LUK ADAPTABLE REF. 73328271 NEW HOLLAND

KIT KUPPLUNG LUK PASSEND ZU REF. 73328271 NEW HOLLAND

KIT EMBRAGUE LUK ADAPTABLE REF. 73328271 NEW HOLLAND

Art./Ref.	Note/Notes	Brand	Applicazione/Application	Rif. Orig./Orig. Ref.	Immagine/Image
<b>LUK628308710</b>	Kit tutto originale LUK composto da - Kit all LUK original consists of: - Meccanismo/Clutch Ref. 228 0136 10 - Disco Pto/Disc Pto 328 0332 10 - Cuscinetto/Bearing Ref. 500 0459 00 - Cuscinetto/Bearing Ref. 500 1292 10 - Cuscinetto/Bearing Ref. 410 0025 00	<b>NEW HOLLAND</b>	TN55 - TN65 - TN70 - TN75, TN55V - TN65V - TN75V, TN60A - TN70A - TN75A, TN60VA - TN70VA, TN65N - TN75N, TN70A - TN75A, TN70NA - TN75NA - TN95NA, TN75VA - TN95VA	73328271	
<b>88971</b>	Meccanismo Frizione 11" - Luk Originale/ Clutch 11" - Original Luk		TN55 - TN65 - TN70 - TN75, TN55V - TN65V - TN75V, TN60A - TN70A - TN75A, TN60VA - TN70VA, TN65N - TN75N, TN70A - TN75A, TN70NA - TN75NA - TN95NA, TN75VA - TN95VA	47134898, 5186552, 5196816, 5196818	
<b>29863</b>	Disco Pto Diametro 280 mm Luk originale/Pto Disc Diameter 280 mm Original Luk		TN55 - TN65 - TN70 - TN75, TN55V - TN65V - TN75V, TN60A - TN70A - TN75A, TN60VA - TN70VA, TN65N - TN75N, TN70A - TN75A, TN70NA - TN75NA - TN95NA, TN75VA - TN95VA	5196819	
<b>LUK500045900</b>	Cuscinetto reggispinta 90 x 50 x 21,60 mm / Thrust Bearing 90 x 50 x 21,60 mm		TD 60 D PLUS, TD 65 F, TD 70 D PLUS, TD 75 F, TD 80 D, TD 80 D PLUS, TD 85 F, TD 90 D, TD 90 D PLUS, TD4020F, TD4030F, TD4040F, TD5.75, TD5.80, TD5.85, TD5.90, TD5010, TD5020, TD5030, TL100, TL80, TL90, TL70A, TL80A, TL90A, TN55, TN65, TN70D, TN60A, TN55S, TN65S, TN70S, TN75S, TN60SA, TN60VA, TN70VA, TN75VA, TN95VA, TN70A, TN75A, TN55D, TN65D, TN60DA, TN70DA, TN75DA, TN70F, TN75F, TN70SA, TN75SA, TN55V, TN65V, TN75V, TN55V, TN65V, TN75V, TN80F, TN95F, TN75FA, TN85FA, TN95FA, TN65N, TN75N, TN70NA	5122028, 82824591, 82824592, 87289219, 87345759, 87541562, 9976506	
<b>LUK500129210</b>	Cuscinetto pto 115 x 75 x 20 mm / Pto Bearing 115 x 75 x 20 mm		L60-L65-L75-L85-L95, T5050 - T5060, TL70A-TL80A-TL90A, TL80 - TL90, TN55D-TN65D-TN70D, TN55S-TN65S-TN70S-TN75S, TN55V-TN65V-TN75V, TN60A-TN70A-TN75A, TN60DA-TN70DA-TN75DA, TN60SA-TN70SA-TN75SA, TN60VA-TN70VA-TN75VA-TN95VA, TN65N-TN75N, TN70F-TN75F-TN80F-TN95F, TN70NA, TN75FA-TN85FA-TN95FA	5112084, 5167183	
<b>LUK410002500</b>	Cuscinetto volano 47 x 17 x 14 mm/Bearing 47 x 17 x 14 mm		L65 - L75 - L85 - L95, T4.75 - T4.85, T4.95 - T4.105, T4020 - T4020V, T4030 - T4030F, T4030N - T4030V, T4040, T4040 - T4040F, T4040N - T4040V, T4050F - T4050N - T4050V, T5030 - T5040, T5050 - T5060, TD 55 D, TD 60 D, TD 60 STRADDLE MOUNT, TD 65 B - D, TD 70 D, TD 70 STRADDLE MOUNT, TD 75 D, TD 80 D, TD 80 STRADDLE MOUNT, TD 85 D, TD 90 D, TD 90 STRADDLE MOUNT, TD4020F, TD4030F, TD4040F, TD5.75, TD5.80, TD5.85, TD5.90, TD5010, TD5020, TD5030, TD5040 - TD5050, TL70 - TL75, TL70A - TL80A - TL90A - TL100A, TL75E - TL85E - TL95E, TL80 - TL85, TL90 - TL95 - TL100, TN65F, TN70F - TN70NA, TN75F - TN75FA, TN80F, TN85A - TN85DA, TN85FA - TN85SA, TN90F, TN95A - TN95DA, TN95F, TN95FA, TN95NA - TN95VA, TT 65 D	28043280	









**KIT FRIZIONE LUK ORIGINALE RIF. 628318112**

KIT EMBRAYAGE LUK ORIGINAL REF. 628318112

KIT CLUTCH ORIGINAL LUK REF. 628318112

KIT KUPPLUNG LUK REF. 628318112

KIT EMBRAGUE LUK ORIGINAL REF. 628318112

Art./Ref.	Note/Notes	Brand	Applicazione/Application	Rif. Orig./Orig. Ref.	Immagine/Image
<b>LUK628318112</b>	Kit tutto originale LUK composto da - Kit all LUK original consists of: - Meccanismo/Clutch Ref. 128 0302 10 - Disco Pto/Disc Pto 328 0332 11 - Cuscinetto/Bearing Ref. 500 1292 10 - Cuscinetto/Bearing Ref. 410 0133 10	<b>NEW HOLLAND</b>	T4020 - T4020V, T4030 - T4030 F-N-V, T4040 - T4040 F-N-V, T4050 F-N-V, TN55 - TN65 . TN70 - TN75, TN55D - TN60D - TN65D - TN75D, TN55S - TN65S - TN70S - TN75S, TN55V - TN65V - TN75V, TN60A - TN70A - TN75A, TN60DA - TN70DA - TN75DA, TN60SA - TN70SA - TN75SA, TN60VA - TN70VA - TN75VA, TN65F - TN75F - TN90F, TN65N - TN75N, TN70NA - TN75NA, TN80F, TN85A - TN85DA - TN85FA, TN85SA, TN95A - TN95DA, TN95F - TN95FA, TN95NA - TN95VA	47134884, 5186548, 5196770, 87732490	   
<b>29865</b>	Meccanismo Frizione 11" - Luk Originale/ Clutch 11" - Original Luk		T4020 - T4020V, T4030 - T4030 F-N-V, T4040 - T4040 F-N-V, T4050 F-N-V, TN55 - TN65 . TN70 - TN75, TN55D - TN60D - TN65D - TN75D, TN55S - TN65S - TN70S - TN75S, TN55V - TN65V - TN75V, TN60A - TN70A - TN75A, TN60DA - TN70DA - TN75DA, TN60SA - TN70SA - TN75SA, TN60VA - TN70VA - TN75VA, TN65F - TN75F - TN90F, TN65N - TN75N, TN70NA - TN75NA, TN80F, TN85A - TN85DA - TN85FA, TN85SA, TN95A - TN95DA, TN95F - TN95FA, TN95NA - TN95VA	47134884, 5186548, 5196770, 87732490	
<b>29414</b>	Disco Pto Diametro 280 mm Luk originale/Pto Disc Diameter 280 mm Original Luk		T4020 - T4020V, T4030 - T4030F, T4030N - T4030V, T4040, T4040 - T4040F, T4040N - T4040V, T4050F - T4050N - T4050V, TN65F, TN70F - TN70NA, TN75F, TN75F - TN75FA, TN80F, TN85A - TN85DA, TN85FA - TN85SA, TN90F, TN95A - TN95DA, TN95F, TN95FA, TN95NA - TN95VA	47134874, 5176450	
<b>LUK500129210</b>	Cuscinetto pto 115 x 75 x 20 mm / Pto Bearing 115 x 75 x 20 mm		L60-L65-L75-L85-L95, T5050 - T5060, TL70A-TL80A-TL90A, TL80 - TL90, TN55D-TN65D-TN70D, TN55S-TN65S-TN70S-TN75S, TN55V-TN65V-TN75V, TN60A-TN70A-TN75A, TN60DA-TN70DA-TN75DA, TN60SA-TN70SA-TN75SA, TN60VA-TN70VA-TN75VA-TN95VA, TN65N-TN75N, TN70F-TN75F-TN80F-TN95F, TN70NA, TN75FA-TN85FA-TN95FA	5112084, 5167183	
<b>LUK410013310</b>	Cuscinetto volano 40 x 17 x 12 mm/Bearing 40 x 17 x 12 mm		T4020 - T4020V, T4030 - T4030 F-N-V, T4040 - T4040 F-N-V, T4050 F-N-V, TN55 - TN65 . TN70 - TN75, TN55D - TN60D - TN65D - TN75D, TN55S - TN65S - TN70S - TN75S, TN55V - TN65V - TN75V, TN60A - TN70A - TN75A, TN60DA - TN70DA - TN75DA, TN60SA - TN70SA - TN75SA, TN60VA - TN70VA - TN75VA, TN65F - TN75F - TN90F, TN65N - TN75N, TN70NA - TN75NA, TN80F, TN85A - TN85DA - TN85FA, TN85SA, TN95A - TN95DA, TN95F - TN95FA, TN95NA - TN95VA	87729147	

**KIT FRIZIONE LUK ORIGINALE RIF. 631200110**

KIT EMBRAYAGE LUK ORIGINAL REF. 631200110

KIT CLUTCH ORIGINAL LUK REF. 631200110

KIT KUPPLUNG LUK REF. 631200110

KIT EMBRAGUE LUK ORIGINAL REF. 631200110

Art./Ref.	Note/Notes	Brand	Applicazione/Application	Rif. Orig./Orig. Ref.	Immagine/Image
<b>LUK631200110</b>	Kit tutto originale LUK composto da - Kit all LUK original consists of: - Meccanismo/Clutch Ref. 231 0089 10 - Disco Pto/Disc Pto 331 0220 10 - Cuscinetto/Bearing Ref. 500 0459 00 - Cuscinetto/Bearing Ref. 500 1292 10 - Cuscinetto/Bearing Ref. 410 0025 00		L65 - L75, TL70 - TL80 - TL90 - TL100	87689674	
<b>29422</b>	Meccanismo Frizione 12" - Luk Originale- Clutch 12" - Original Luk- Luk/Embrague 12" - Original Luk		L65 - L75, TL70 - TL80 - TL90 - TL100	5167933	
<b>29421</b>	Disco Pto Diametro 310 mm Luk originale/Pto Disc Diameter 310 mm Original Luk	<b>NEW HOLLAND</b>	L65 - L75 - L85 - L95, T4.75 - T4.85, T4.95 - T4.105, T5030 - T5040, T5050 - T5060, TD5040 - TD5050, TL70 - TL75, TL70A - TL80A - TL90A - TL100A, TL75E - TL85E - TL95E, TL80 - TL85, TL90 - TL95 - TL100	5167937	
<b>LUK500045900</b>	Cuscinetto reggispinta 90 x 50 x 21,60 mm / Thrust Bearing 90 x 50 x 21,60 mm		TD 60 D PLUS, TD 65 F, TD 70 D PLUS, TD 75 F, TD 80 D, TD 80 D PLUS, TD 85 F, TD 90 D, TD 90 D PLUS, TD4020F, TD4030F, TD4040F, TD5.75, TD5.80, TD5.85, TD5.90, TD5010, TD5020, TD5030, TL100, TL80, TL90, TL70A, TL80A, TL90A, TN55, TN65, TN70D, TN60A, TN55S, TN65S, TN70S, TN75S, TN60SA, TN60VA, TN70VA, TN75VA, TN95VA, TN70A, TN75A, TN55D, TN65D, TN60DA, TN70DA, TN75DA, TN70F, TN75F, TN70SA, TN75SA, TN55V, TN65V, TN75V, TN55V, TN65V, TN75V, TN80F, TN95F, TN75FA, TN85FA, TN95FA, TN65N, TN75N, TN70NA	5122028, 82824591, 82824592, 87289219, 87345759, 87541562, 9976506	
<b>LUK500129210</b>	Cuscinetto pto 115 x 75 x 20 mm / Pto Bearing 115 x 75 x 20 mm		L60-L65-L75-L85-L95, T5050 - T5060, TL70A-TL80A-TL90A, TL80 - TL90, TN55D-TN65D-TN70D, TN55S-TN65S-TN70S-TN75S, TN55V-TN65V-TN75V, TN60A-TN70A-TN75A, TN60DA-TN70DA-TN75DA, TN60SA-TN70SA-TN75SA, TN60VA-TN70VA-TN75VA-TN95VA, TN65N-TN75N, TN70F-TN75F-TN80F-TN95F, TN70NA, TN75FA-TN85FA-TN95FA	5112084, 5167183	
<b>LUK410002500</b>	Cuscinetto volano 47 x 17 x 14 mm /Bearing 47 x 17 x 14 mm		L65 - L75 - L85 - L95, T4.75 - T4.85, T4.95 - T4.105, T4020 - T4020V, T4030 - T4030F, T4030N - T4030V, T4040, T4040 - T4040F, T4040N - T4040V, T4050F - T4050N - T4050V, T5030 - T5040, T5050 - T5060, TD 55 D, TD 60 D, TD 60 STRADDLE MOUNT, TD 65 B - D, TD 70 D, TD 70 STRADDLE MOUNT, TD 75 D, TD 80 D, TD 80 STRADDLE MOUNT, TD 85 D, TD 90 D, TD 90 STRADDLE MOUNT, TD4020F, TD4030F, TD4040F, TD5.75, TD5.80, TD5.85, TD5.90, TD5010, TD5020, TD5030, TD5040 - TD5050, TL70 - TL75, TL70A - TL80A - TL90A - TL100A, TL75E - TL85E - TL95E, TL80 - TL85, TL90 - TL95 - TL100, TN65F, TN70F - TN70NA, TN75F - TN75FA, TN80F, TN85A - TN85DA, TN85FA - TN85SA, TN90F, TN95A - TN95DA, TN95F, TN95FA, TN95NA - TN95VA, TT 65 D	28043280	





**KIT FRIZIONE LUK ORIGINALE RIF. 131024910+331021910+500124010**

KIT EMBRAYAGE LUK ORIGINAL REF. 131024910+331021910+500124010

KIT CLUTCH ORIGINAL LUK REF. 131024910+331021910+500124010

KIT KUPPLUNG LUK REF. 131024910+331021910+500124010

KIT EMBRAGUE LUK ORIGINAL REF. 131024910+331021910+500124010

Art./Ref.	Note/Notes	Brand	Applicazione/Application	Rif. Orig./Orig. Ref.	Immagine/Image
<b>29418</b>	Meccanismo Frizione 12" - Luk originale/ Clutch 12" - Original Luk12" - Original Luk	<b>NEW HOLLAND</b>	L75, L85, L95, T5030-T5040-T5050-T5060, TL100, TL100A, TL70, TL70A, TL80, TL80A, TL90, TL90A	5167939, 5189823	
<b>29419</b>	Disco avanzamento Ø 310 mm a 7 pale LUK originale // Clutch Disc Ø 310 mm 7 pairs of pads Original LUK		L75,L85,L95, TL100,TL90,TL80,TL70,TL100A, TL70A,TL80A,TL90A	5167936, 5179851, 5189825, 87716700	
<b>LUK500124010</b>	Cuscinetto reggispinta completo 110 x 65 x 210 mm / Bearing + carrier assy 110 x 65 x 210 mm		L75, L85, L95, T5030-T5040-T5050-T5060, TL100, TL100A, TL70, TL70A, TL80, TL80A, TL90, TL90A	5166287	





**KIT FRIZIONE LUK ORIGINALE RIF. MECCANISMO 84177326**

KIT EMBRAYAGE LUK ORIGINAL REF. 84177326

KIT CLUTCH ORIGINAL LUK REF. 84177326

KIT KUPPLUNG LUK REF. 84177326

KIT EMBRAGUE LUK ORIGINAL REF. 84177326

Art./Ref.	Note/Notes	Brand	Applicazione/Application	Rif. Orig./Orig. Ref.	Immagine/Image
<b>LUK228018610</b>	Meccanismo Frizione 11" - Luk originale/ Clutch 11" - Original Luk	<b>NEW HOLLAND</b>	TD 60 D PLUS, TD 65 F, TD 70 D PLUS, TD 75 F, TD 80 D, TD 80 D PLUS, TD 85 F, TD 90 D, TD 90 D PLUS, TD4020F, TD4030F, TD4040F, TD5.75, TD5.80, TD5.85, TD5.90, TD5010, TD5020, TD5030	84177326	
<b>07852</b>	Disco Pto Diametro 280 mm Luk originale/ Pto Disc Diameter 280 mm Original Luk		TD 55 D, TD 60 D, TD 60 STRADDLE MOUNT, TD 65 B - D, TD 70 D, TD 70 STRADDLE MOUNT, TD 75 D, TD 80 D, TD 80 STRADDLE MOUNT, TD 85 D, TD 90 D, TD 90 STRADDLE MOUNT, TD4020F - TD4030F - TD4040F, TD5.75 - TD5.80, TD5.85 - TD5.90, TD5010 - TD5020 - TD5030, TD85D,TD90D,TK4030, TK80.66 DT, TT 65 D	5145715, 5154703	
<b>LUK500045900</b>	Cuscinetto reggispinta 90 x 50 x 21,60 mm / Thrust Bearing 90 x 50 x 21,60 mm		TD 60 D PLUS, TD 65 F, TD 70 D PLUS, TD 75 F, TD 80 D, TD 80 D PLUS, TD 85 F, TD 90 D, TD 90 D PLUS, TD4020F, TD4030F, TD4040F, TD5.75, TD5.80, TD5.85, TD5.90, TD5010, TD5020, TD5030, TL100,TL80,TL90,TL70A,TL80A, TL90A, TN55, TN65, TN70D, TN60A, TN55S, TN65S, TN70S, TN75S, TN60SA, TN60VA, TN70VA, TN75VA, TN95VA, TN70A, TN75A, TN55D, TN65D, TN60DA, TN70DA, TN75DA, TN70F, TN75F, TN70SA, TN75SA, TN55V, TN65V, TN75V, TN55V, TN65V, TN75V, TN80F, TN95F, TN75FA, TN85FA, TN95FA, TN65N, TN75N, TN70NA	5122028, 82824591, 82824592, 87289219, 87345759, 87541562, 9976506	
<b>LUK500028400</b>	Cuscinetto pto 110 x 70 x 20 mm / Pto Bearing 110 x 70 x 20 mm		T7030-T7040-T7050-T7060-T7070, TD4020F-TD4030F-TD4040F, TD5.100-TD5.105, TD5.110-TD5.115, TD5.65-TD5.75-TD5.80, TD5.85. TD5.90-TD5.95, TD5010-TD5020-TD5030, TD5040-TD5050, TD60- TD70-TD80-TD90-TD95, TD60D-TD70D-TD80D-TD90D-TD95D, TD65B, TD65F-TD75F-TD85F, TD85D, TD90D, TK4030, TK80.66DT, TT50-TT55- TT65-TT65D-TT75	24905360	
<b>LUK410002500</b>	Cuscinetto volano 47 x 17 x 14 mm/Bearing 47 x 17 x 14 mm		L65 - L75 - L85 - L95, T4.75 - T4.85, T4.95 - T4.105, T4020 - T4020V, T4030 - T4030F, T4030N - T4030V, T4040, T4040 - T4040F, T4040N - T4040V, T4050F - T4050N - T4050V, T5030 - T5040, T5050 - T5060, TD 55 D, TD 60 D, TD 60 STRADDLE MOUNT, TD 65 B - D, TD 70 D, TD 70 STRADDLE MOUNT, TD 75 D, TD 80 D, TD 80 STRADDLE MOUNT, TD 85 D, TD 90 D, TD 90 STRADDLE MOUNT, TD4020F, TD4030F, TD4040F, TD5.75, TD5.80, TD5.85, TD5.90, TD5010, TD5020, TD5030, TD5040 - TD5050, TL70 - TL75, TL70A - TL80A - TL90A - TL100A, TL75E - TL85E - TL95E, TL80 - TL85, TL90 - TL95 - TL100, TN65F, TN70F - TN70NA, TN75F - TN75FA, TN80F, TN85A - TN85DA, TN85FA - TN85SA, TN90F, TN95A - TN95DA, TN95F, TN95FA, TN95NA - TN95VA, TT 65 D	28043280	

**KIT FRIZIONE LUK ORIGINALE RIF. MECCANISMO 5177618**

KIT EMBRAYAGE LUK ORIGINAL REF. 5177618  
 KIT CLUTCH ORIGINAL LUK REF. 5177618  
 KIT KUPPLUNG LUK REF. 5177618  
 KIT EMBRAGUE LUK ORIGINAL REF. 5177618

Art./Ref.	Note/Notes	Brand	Applicazione/Application	Rif. Orig./Orig. Ref.	Immagine/Image
07877	Meccanismo Frizione 13" - Luk originale/Clutch 13" - Original Luk	NEW HOLLAND	M100 - M115 - M135, TM110 - TM115, TM120 - TM125, TM130 - TM140	5177618	
07878	Disco avanzamento 330 mm a 5 pale Luk originale / Clutch Disc Diameter 330 mm 5 pairs of pads Original Luk		M100 - M115 - M135, TM110 - TM115, TM120 - TM125, TM130 - TM140	5165650	
LUK500085130	Cuscinetto reggispinta completo 115 x 65 x 30 mm / Bearing + carrier assy 115 x 65 x 30 mm		M100 - M115 - M135, TM110 - TM120 - TM130 - TM135, TM115 - TM125, TM125, TM140 - TM150, TM7010 - TM7020, TM7030 - TM7040	5149611, 9967339	

**KIT FRIZIONE LUK ORIGINALE RIF. MECCANISMO 5092803**

KIT EMBRAYAGE LUK ORIGINAL REF. 5092803  
 KIT CLUTCH ORIGINAL LUK REF. 5092803  
 KIT KUPPLUNG LUK REF. 5092803  
 KIT EMBRAGUE LUK ORIGINAL REF. 5092803

Art./Ref.	Note/Notes	Brand	Applicazione/Application	Rif. Orig./Orig. Ref.	Immagine/Image
VALE0805980	Meccanismo Frizione 12" - Valeo originale/ Clutch 12" - Original Valeo	NEW HOLLAND	TD5040, TD5050, TD60, TD60D PLUS, TD70, TD70D PLUS, TD80, TD80D PLUS, TD90, TD90D PLUS, TD95, TD95 STRADDLE MOUNT, TD95D, TD95D PLUS	5092803, 84177332	
LUK331032310	Disco Pto Diametro 310 mm Luk originale/ Pto Disc Diameter 310 mm Original Luk		TD5040, TD5050, TD60, TD60D PLUS, TD70, TD70D PLUS, TD80, TD80D PLUS, TD90, TD90D PLUS, TD95, TD95 STRADDLE MOUNT, TD95D, TD95D PLUS	5089337, 5092802	
LUK500045900	Cuscinetto reggispinta 90 x 50 x 21,60 mm / Thrust Bearing 90 x 50 x 21,60 mm		TD 60 D PLUS, TD 65 F, TD 70 D PLUS, TD 75 F, TD 80 D, TD 80 D PLUS, TD 85 F, TD 90 D, TD 90 D PLUS, TD4020F, TD4030F, TD4040F, TD5.75, TD5.80, TD5.85, TD5.90, TD5010, TD5020, TD5030, TL100, TL80, TL90, TL70A, TL80A, TL90A, TN55, TN65, TN70D, TN60A, TN55S, TN65S, TN70S, TN75S, TN60SA, TN60VA, TN70VA, TN75VA, TN95VA, TN70A, TN75A, TN55D, TN65D, TN60DA, TN70DA, TN75DA, TN70F, TN75F, TN70SA, TN75SA, TN55V, TN65V, TN75V, TN55V, TN65V, TN75V, TN80F, TN95F, TN75FA, TN85FA, TN95FA, TN65N, TN75N, TN70NA	5122028, 82824591, 82824592, 87289219, 87345759, 87541562, 9976506	
LUK500028400	Cuscinetto pto 110 x 70 x 20 mm / Pto Bearing 110 x 70 x 20 mm		T7030-T7040-T7050-T7060-T7070, TD4020F-TD4030F-TD4040F, TD5.100-TD5.105, TD5.110-TD5.115, TD5.65-TD5.75-TD5.80, TD5.85, TD5.90-TD5.95, TD5010-TD5020-TD5030, TD5040-TD5050, TD60-TD70-TD80-TD90-TD95, TD60D-TD70D-TD80D-TD90D-TD95D, TD65B, TD65F-TD75F-TD85F, TD85D, TD90D, TK4030, TK80.66DT, TT50-TT55-TT65-TT65D-TT75	24905360	
LUK410002500	Cuscinetto volano 47 x 17 x 14 mm/Bearing 47 x 17 x 14 mm		L65 - L75 - L85 - L95, T4.75 - T4.85, T4.95 - T4.105, T4020 - T4020V, T4030 - T4030F, T4030N - T4030V, T4040, T4040 - T4040F, T4040N - T4040V, T4050F - T4050N - T4050V, T5030 - T5040, T5050 - T5060, TD 55 D, TD 60 D, TD 60 STRADDLE MOUNT, TD 65 B - D, TD 70 D, TD 70 STRADDLE MOUNT, TD 75 D, TD 80 D, TD 80 STRADDLE MOUNT, TD 85 D, TD 90 D, TD 90 STRADDLE MOUNT, TD4020F, TD4030F, TD4040F, TD5.75, TD5.80, TD5.85, TD5.90, TD5010, TD5020, TD5030, TD5040 - TD5050, TL70 - TL75, TL70A - TL80A - TL90A - TL100A, TL75E - TL85E - TL95E, TL80 - TL85, TL90 - TL95 - TL100, TN65F, TN70F - TN70NA, TN75F - TN75FA, TN80F, TN85A - TN85DA, TN85FA - TN85SA, TN90F, TN95A - TN95DA, TN95F, TN95FA, TN95NA - TN95VA, TT 65 D	28043280	



**MECCANISMO + DISCO PTO ORIGINALE LUK RIF. 623306509**

MECANISME + DISQUE PTO ORIGINAL LUK 623306509

COVER ASSEMBLY + ORIGINAL PTO DISC LUK REF. 623306509

GETRIEBE + ZAPFWELLENSCHEIBE LUK 623306509

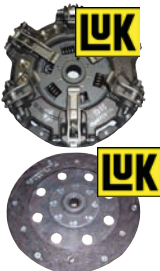
MECANISMO + DISCO PTO ORIGINAL LUK REF. 623306509

Art./Ref.	Note/Notes	Brand	Applicazione/Application	Rif. Orig./Orig. Ref.	Immagine/Image
<b>LUK623306509</b>	Kit tutto originale LUK composto da - Kit all LUK original consists of: - Meccanismo/Clutch Ref. 223 0028 10 - Disco Pto/Disc Pto 323 0471 10		T3010 - T3020 - T3030 - T3040, TCE40 - TCE45 - TCE50 - TCE55	87291158	
<b>LUK500045900</b>	Cuscinetto reggispinta 90 x 50 x 21,60 mm / Thrust Bearing 90 x 50 x 21,60 mm	<b>NEW HOLLAND</b>	TD 60 D PLUS, TD 65 F, TD 70 D PLUS, TD 75 F, TD 80 D, TD 80 D PLUS, TD 85 F, TD 90 D, TD 90 D PLUS, TD4020F, TD4030F, TD4040F, TD5.75, TD5.80, TD5.85, TD5.90, TD5010, TD5020, TD5030, TL100, TL80, TL90, TL70A, TL80A, TL90A, TN55, TN65, TN70D, TN60A, TN55S, TN65S, TN70S, TN75S, TN60SA, TN60VA, TN70VA, TN75VA, TN95VA, TN70A, TN75A, TN55D, TN65D, TN60DA, TN70DA, TN75DA, TN70F, TN75F, TN70SA, TN75SA, TN55V, TN65V, TN75V, TN55V, TN65V, TN75V, TN80F, TN95F, TN75FA, TN85FA, TN95FA, TN65N, TN75N, TN70NA	5122028, 82824591, 82824592, 87289219, 87345759, 87541562, 9976506	
<b>LUK500067300</b>	Cuscinetto pto 100 x 65 x 18 mm / Pto Bearing 100 x 65 x 18 mm		T3010 - T3020 - T3030 - T3040, TCE40 - TCE45 - TCE50 - TCE55	24905350	

**KIT FRIZIONE LUK ADATTABILE RIF. 87689675 STEYR**





KIT EMBRAYAGE LUK ADAPTABLE REF. 87689675 STEYR

KIT CLUTCH LUK ADAPTABLE REF. 87689675 STEYR

KIT KUPPLUNG LUK PASSEND ZU REF. 87689675 STEYR

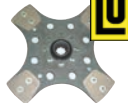
KIT EMBRAGUE LUK ADAPTABLE REF. 87689675 STEYR

Art./Ref.	Note/Notes	Brand	Applicazione/Application	Rif. Orig./Orig. Ref.	Immagine/Image
<b>LUK628308610</b>	Kit tutto originale LUK composto da - Kit all LUK original consists of: - Meccanismo/Clutch Ref. 228 0184 10 - Disco Pto/Disc Pto 328 0332 10 - Cuscinetto/Bearing Ref. 500 0459 00 - Cuscinetto/Bearing Ref. 500 1292 10 - Cuscinetto/Bearing Ref. 410 0025 00	<b>STEYR</b>	4065 KOMPAKT, 4075 KOMPAKT	87689675	

Art./Ref.	Note/Notes	Brand	Applicazione/Application	Rif. Orig./Orig. Ref.	Immagine/Image
<b>29416</b>	Meccanismo Frizione 11" - Luk originale/Embrayage 11" - Original Luk/Clutch 11" - Original Luk/Kupplung 11" - Luk/Embrague 11" - Original Luk	<b>STEYR</b>	370 - 375 KOMPACT, 4065 KOMPACT, 4075 KOMPACT, 4085 KOMPACT, 485 - 495 KOMPACT	5181421, 5196813, 87732504, 87732506	
<b>29414</b>	Disco Pto Diametro 280 mm Luk originale/Pto Disc Diameter 280 mm Original Luk		370 - 375 KOMPACT, 4065 KOMPACT, 4075 KOMPACT, 4085 KOMPACT, 485 - 495 KOMPACT	47134874, 5176450	
<b>LUK500045900</b>	Cuscinetto reggispinta 90 x 50 x 21,60 mm / Thrust Bearing 90 x 50 x 21,60 mm		360 KOMP.(SYNCHRO SHIFT 16X16), 370 KOMPACT, 375 KOMPACT, 485 KOMPACT, 40555 KOMPACT, 4065 KOMPACT, 40655 KOMPACT, 4075 KOMPACT, 4085 KOMPACT, 4095 KOMPACT, 485 KOMPACT, 495 KOMPACT, M952, M963KOMP.(SYNCHRO SHIFT 16X16)	87345759	
<b>LUK500129210</b>	Cuscinetto pto 115 x 75 x 20 mm / Pto Bearing 115 x 75 x 20 mm		370 - 375 KOMPACT, 4065 KOMPACT, 4075 KOMPACT, 4085 KOMPACT, 485 - 495 KOMPACT	5112084	
<b>LUK410002500</b>	Cuscinetto volano 47 x 17 x 14 mm / Bearing 47 x 17 x 14 mm		370 - 375 KOMPACT, 4065 KOMPACT, 4075 KOMPACT, 4085 KOMPACT, 485 - 495 KOMPACT	28043280	







**KIT FRIZIONE LUK ORIGINALE RIF. 628318112**

KIT EMBRAYAGE LUK ORIGINAL REF. 628318112

KIT CLUTCH ORIGINAL LUK REF. 628318112

KIT KUPPLUNG LUK REF. 628318112

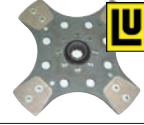
KIT EMBRAGUE LUK ORIGINAL REF. 628318112

Art./Ref.	Note/Notes	Brand	Applicazione/Application	Rif. Orig./Orig. Ref.	Immagine/Image
<b>LUK628318112</b>	Kit tutto originale LUK composto da - Kit all LUK original consists of: - Meccanismo/Clutch Ref. 128 0302 10 - Disco Pto/Disc Pto 328 0332 11 - Cuscinetto/Bearing Ref. 500 1292 10 - Cuscinetto/Bearing Ref. 410 0133 10	<b>STEYR</b>	360 KOMPACT, 370 KOMPACT, 375 KOMPACT, 4065 KOMPACT, 4075 KOMPACT, 4085 KOMPACT, 485 KOMPACT, 495 KOMPACT	47134884, 5186548, 5196770, 87732490	   
<b>29865</b>	Meccanismo Frizione 11" - Luk Originale/Clutch 11" - Original Luk		360 KOMPACT, 370 KOMPACT, 375 KOMPACT, 4065 KOMPACT, 4075 KOMPACT, 4085 KOMPACT, 485 KOMPACT, 495 KOMPACT	47134884, 5186548, 5196770, 87732490	
<b>29414</b>	Disco Pto Diametro 280 mm Luk originale / Pto Disc Diameter 280 mm Original Luk		360 KOMPACT, 370 - 375 KOMPACT, 4065 KOMPACT, 4075 KOMPACT, 4085 KOMPACT, 485 - 495 KOMPACT	47134874, 5176450	
<b>LUK500129210</b>	Cuscinetto pto 115 x 75 x 20 mm / Pto Bearing 115 x 75 x 20 mm		360 KOMPACT, 370 - 375 KOMPACT, 4065 KOMPACT, 4075 KOMPACT, 4085 KOMPACT, 485 - 495 KOMPACT	5112084	
<b>LUK410013310</b>	Cuscinetto volano 40 x 17 x 12 mm / Bearing 40 x 17 x 12 mm		360 KOMPACT, 370 KOMPACT, 375 KOMPACT, 4065 KOMPACT, 4075 KOMPACT, 4085 KOMPACT, 485 KOMPACT, 495 KOMPACT	87729147	



**KIT FRIZIONE ADATTABILE RIF. 628052210 LANDINI**

KIT EMBRAYAGE ADAPTABLE REF. 628052210 LANDINI



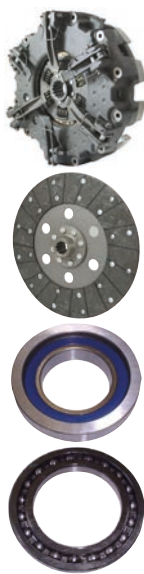

KIT CLUTCH ADAPTABLE REF. 628052210 LANDINI

KIT KUPPLUNG PASSEND ZU REF. 628052210 LANDINI

KIT EMBRAGUE ADAPTABLE REF. 628052210 LANDINI

Art./Ref.	Note/Notes	Brand	Applicazione/Application	Rif. Orig./Orig. Ref.	Immagine/Image
<b>83940</b>	Kit composto da - Kit consists of: - Meccanismo/ Clutch Ref. 3540480M92 With box Original LANDINI - Disco Pto/Disc Pto Ref. 1424135M93 Not Original - Cuscinetto/ Bearing Ref. 1423473M94 Not Original - Cuscinetto/ Bearing Ref. 1442381X1 Not Original		4530V-5530F-5530L-5530V-6030F, 5830-6030-6830-7830, 5840-6040-6840, 5860-6060-7860, 5860-8860, 6060F-6060L-6060V, 6070-6870-7870-8870, 6500-7500-8500, 6550-7550-8550, 6880-6880VM, 7530F-7530L-8830, 7880, ADVANTAGE 55F-55FP-55GE, ADVANTAGE 55GT-55GTP-55LP-55V, ADVANTAGE 60F-60FP-60GE-60GT, ADVANTAGE 60GTP-60L-60LP, ADVANTAGE 75F-75FP-75GE-75GT, ADVANTAGE 75GTP-75L-75LP-75V, ADVANTAGE 85F-85FP-85GE-85GT, ADVANTAGE 85GTP-85L-85LP, ATLAS 80 - 85 - 90 - 100, ATLATINS 80 - 85 - 90 - 100, BLIZZARD 50 - 60 - 75 - 85, CINGOLATI C4830-C5830, CINGOLATI C6830-C7830, GHIBLI 80 - 90 - 100, GHIBLI 85 - 95 - 105, POWERFARM 60, POWERFARM 75 - 85 - 95 - 105, REX 80FP - 80GE - 80GTP, REX CAB 60, TREKKER 65F, TREKKER CF55 - CF60 - CF75	3540480M91, 3540480M92	
<b>LN3540480M91</b>	Meccanismo Fri- zione 11" - Landini originale/Clutch 11" - Original Landini	<b>LANDINI</b>	4530V-5530F-5530L-5530V-6030F, 5830-6030-6830-7830, 5840-6040-6840, 5860-6060-7860, 5860-8860, 6060F-6060L-6060V, 6070-6870-7870-8870, 6500-7500-8500, 6550-7550-8550, 6880-6880VM, 7530F-7530L-8830, 7880, ADVANTAGE 55F-55FP-55GE, ADVANTAGE 55GT-55GTP-55LP-55V, ADVANTAGE 60F-60FP-60GE-60GT, ADVANTAGE 60GTP-60L-60LP, ADVANTAGE 75F-75FP-75GE-75GT, ADVANTAGE 75GTP-75L-75LP-75V, ADVANTAGE 85F-85FP-85GE-85GT, ADVANTAGE 85GTP-85L-85LP, ATLAS 80 - 85 - 90 - 100, ATLATINS 80 - 85 - 90 - 100, BLIZZARD 50 - 60 - 75 - 85, CINGOLATI C4830-C5830, CINGOLATI C6830-C7830, GHIBLI 80 - 90 - 100, GHIBLI 85 - 95 - 105, POWERFARM 60, POWERFARM 75 - 85 - 95 - 105, REX 80FP - 80GE - 80GTP, REX CAB 60, TREKKER 65F, TREKKER CF55 - CF60 - CF75	3540480M91, 3540480M92	
<b>70467</b>	Disco Pto Diametro 280 mm/Pto Disc Diameter 280 mm		5500, 5830, 5840, 5860, 5860 (DAL P50187, 5870, 5870 (DAL P50187), 6030, 6040, 6060, 6060 (DAL P50187), 6070, 6070 (DAL P50187), 6500, 6550, 6830, 6840, 6860, 6870, 6880, 7500, 7550, 7830, 7860, 7870, 8500, 8550, 8830, 8860, 8870, ADVANTAGE CAB E F.S.:55, ADVANTAGE CAB E F.S.:60, ADVANTAGE CAB E F.S.:65, ADVANTAGE CAB E F.S.:75, ADVANTAGE CAB E F.S.:85, ATLAS:100, ATLAS:70, ATLAS:75, ATLAS:80, ATLAS:85, ATLAS:90, BLIZZARD:50, BLIZZARD:60, BLIZZARD:65, BLIZZARD:75, BLIZZARD:85, CINGOLATI: C5500, CINGOLATI: CF5830, CINGOLATI: CF6030, CINGOLATI:8860, CINGOLATI:C4500, CINGOLATI:C4830, CINGOLATI:C5830, CINGOLATI:C6500, CINGOLATI:C6830, CINGOLATI:C7800, CINGOLATI:C7830, CINGOLATI:CF4830, CINGOLATI:CF5030, CINGOLATI:CF6060, CINGOLATI:CF6830, FRUTTETI 530 F/L/V:4530, FRUTTETI 530 F/L/V:5530, FRUTTETI 530 F/L/V:6030, FRUTTETI 530 F/L/V:6530, FRUTTETI 530 F/L/V:7530, FRUTTETI 530 F/L/V:8530, FRUTTETI 560 F/L/V:5560, FRUTTETI 560 F/L/V:5560V/L, FRUTTETI 560 F/L/V:6060, FRUTTETI 560 F/L/V:6060V/L, FRUTTETI 560 F/L/V:6560, FRUTTETI 560 F/L/V:7560, FRUTTETI 560 F/L/V:8560, POWER FARM:60, POWER FARM:75, POWER FARM:85, REX CAB E FOOT STEP:60, REX CAB E FOOT STEP:70, REX CAB E FOOT STEP:80, REX NEW TIER 2:60, REX NEW TIER 2:75, REX NEW TIER 2:85, SERIE 60 NEW :6860, SERIE 60 NEW:5860, TREKKER :C75, TREKKER :CF65, TREKKER :CF70, TREKKER :CF75, TREKKER :CF85, TREKKER COMPACT TIER 2:CF60, TREKKER COMPACT TIER 2:CF70, TREKKER NEW TIER 2:75, TREKKER NEW TIER 2:85, TREKKER NEW:70C/F/L, TREKKER NEW:80C/F/L, TREKKER:CF55, TREKKER:CF60, VIGNETI CAB E FOOT STEP :55V, VIGNETI CAB E FOOT STEP :60V, VIGNETI CAB E FOOT STEP :65V, VIGNETI CAB E FOOT STEP :75V, VIGNETI CAB E FOOT STEP:75V, VIGNETI REX CAB :60V, VIGNETI REX CAB :65V, VIGNETI REX CAB TIER 2 :75V	1424135M91, 1424135M93	

Art./Ref.	Note/Notes	Brand	Applicazione/Application	Rif. Orig./Orig. Ref.	Immagine/Image
12841	Cuscinetto reggi-spinta 90 x 50 x 21,60 mm / Thrust Bearing 90 x 50 x 21,60 mm		4530V,5530F,5530L,5530V,5830, 5500,6500,7500,8500,5860,6060, 5840,6040,6840,6550,7550,8550, 6030,6030F,6030L,6030V,6530F, 6060F/L/V,6860,7860,5860,6860, 6530L,6530V,6830,7530F,7530L, 6870,7870,8870,6880,7880,8880, 7830,8530F,8530L,8830, 7860,8860,5865,6865,7860,8865, 9880,C4830,C5830,C6830,C7830, GHIBLI 80/90/100, GHIBLI TIER2 85/95/105, GLOBALFARM 90/95/100/105, GLOBUS 55, POWERFARM 60/75/85/95/105, REX 100FP/GE/GTP, REX 60FP/GE/LP, REX 60V/65V/70V/80V, REX 70/FP/GE/GTP/LP, REX 80FP/GE/GTP/LP, REX 90FP/GE/GTP, REX CAB 60/70/80/90/100, REX TIER2 105F/GE/GT/, REX TIER2 60F/GE, REX TIER2 70F/GE, REX TIER2 75F/GE/GT, REX TIER2 80F/GE, REX TIER2 85F/GE/GT, REX TIER2 90GT, REX TIER2 95F/GE/GT, TREKKER 100C, TREKKER 105C/F/M, TREKKER 70C/F/L, TREKKER 75C/F/M, TREKKER 80C/F/L, TREKKER 85C/F/M, TREKKER 90C/F/L, TREKKER 95C/F/M, TREKKER CF60/CF70, VIGNETI 55V, VIGNETI 60V/65V/70V/80V, VIGNETI 75V	1423473M91, 1423473M93, 1423473M94, 391347X1	
15757	Cuscinetto pto 100 x 65 x 11 mm / Pto Bearing 100 x 65 x 11 mm / Cuscinetto pto 100 x 65 x 11 mm / Pto Bearing 100 x 65 x 11 mm / Cuscinetto pto 100 x 65 x 11 mm / Cuscinetto pto 100 x 65 x 11 mm / Pto Bearing 100 x 65 x 11 mm / Cuscinetto pto 100 x 65 x 11 mm / Pto Bearing 100 x 65 x 11 mm	LANDINI	5500, 5830, 5840, 5860, 5860 (DAL P50187, 5870, 5870 (DAL P50187)), 6030, 6040, 6060, 6060(DAL P50187), 6070, 6070 (DAL P50187), 6840, 6870, 6880, 7500, 7550, 7830, 7860, 7870, 7880, 8500, 8550, 8830, 8860, 8870, 8880, 9060, 9080, 9880, ADVANTAGE CAB E F.S.:55, ADVANTAGE CAB E F.S.:60, ADVANTAGE CAB E F.S.:65, ADVANTAGE CAB E F.S.:85, ADVANTAGE CAB E F.S.:95, ATLANTIS 100,70,75,80,85,90, ATLAS:100, ATLAS:70, ATLAS:75, ATLAS:80, ATLAS:85, ATLAS:90, BLIZZARD:50, BLIZZARD:60, BLIZZARD:65, BLIZZARD:75, BLIZZARD:85, BLIZZARD:95, CINGOLATI: CF6030, CINGOLATI:8860, CINGOLATI:C4500, CINGOLATI:C6500, CINGOLATI:C6830, CINGOLATI:C7800, CINGOLATI:CF5030, CINGOLATI:CF6830, FRUTTETI 530 F/L/V:4530, FRUTTETI 530 F/L/V:5530, FRUTTETI 530 F/L/V:6030, FRUTTETI 530 F/L/V:6530, FRUTTETI 530 F/L/V:7530, FRUTTETI 530 F/L/V:8530, FRUTTETI 560 F/L/V:5560, FRUTTETI 560 F/L/V:5560V/L, FRUTTETI 560 F/L/V:6060, FRUTTETI 560 F/L/V:6060V/L, FRUTTETI 560 F/L/V:6560, FRUTTETI 560 F/L/V:7560, FRUTTETI 560 F/L/V:8560, GHIBLI NEW TIER 2:105, GHIBLI NEW TIER 2:85, GHIBLI NEW TIER 2:95, GHIBLI: 80, GHIBLI:90, POWER FARM:105, POWER FARM:60, POWER FARM:75, POWER FARM:85, POWER FARM:95, REX CAB E FOOT STEP: 100, REX CAB E FOOT STEP: 70, REX CAB E FOOT STEP: 80, REX CAB E FOOT STEP: 90, REX CAB E FOOT STEP:60, REX CAB E FOOT STEP:70, REX CAB E FOOT STEP:80, REX NEW TIER 2:60, REX NEW TIER 2:75, REX NEW TIER 2:85, REX NEW TIER 2 FP/CAB:105, REX TIER 2 FP/CAB:75, REX TIER 2 FP/CAB:85, REX TIER 2 FP/CAB:95, SERIE 60 NEW :6860, SERIE 60 NEW:5860, SERIE 60 NEW:7860, SERIE 60 NEW:8860, TREKKER :CF70, TREKKER :CF75, TREKKER COMPACT TIER 2:CF60, TREKKER COMPACT TIER 2:CF70, TREKKER NEW TIER 2:105, TREKKER NEW TIER 2:75, TREKKER NEW TIER 2:85, TREKKER NEW TIER 2:95, TREKKER NEW:100C, TREKKER NEW:70 C/F/L, TREKKER NEW:70C/F/L, TREKKER NEW:80 C/F/L, TREKKER NEW:80C/F/L, TREKKER NEW:90 C/F/L, TREKKER:C75, TREKKER:C85, TREKKER:C95, VIGNETI CAB E FOOT STEP :65V, VIGNETI CAB E FOOT STEP :75V, VIGNETI CAB E FOOT STEP:65V, VIGNETI CAB E FOOT STEP:75V, VIGNETI REX CAB :65V, VIGNETI REX CAB TIER 2 :75V, VIGNETI REX CAB TIER 2:85V, VIGNETI REX CAB:70V, VIGNETI REX CAB:80V	1442381X1	
85025	Kit composto da - Kit consists of: - Meccanismo/ Clutch Ref. 3540480M92 With box Original LUK - Disco Pto/Disc Pto Ref. 1424135M93 Not Original - Cuscinetto/ Bearing Ref. 1423473M94 Not Original - Cuscinetto/ Bearing Ref. 1442381X1 Not Original	LANDINI	4530V-5530F-5530L-5530V-6030F, 5830-6030-6830-7830, 5840-6040-6840, 5860-6060-7860, 5860-8860, 6060F-6060L-6060V, 6070-6870-7870-8870, 6500-7500-8500, 6550-7550-8550, 6880-6880VM, 7530F-7530L-8830, 7880, ADVANTAGE 55F-55FP-55GE, ADVANTAGE 55GT-55GTP-55LP-55V, ADVANTAGE 60F-60FP-60GE-60GT, ADVANTAGE 60GTP-60L-60LP, ADVANTAGE 75F-75FP-75GE-75GT, ADVANTAGE 75GTP-75L-75LP-75V, ADVANTAGE 85F-85FP-85GE-85GT, ADVANTAGE 85GTP-85L-85LP, ATLAS 80 - 85 - 90 - 100, ATLANTIS 80 - 85 - 90 - 100, BLIZZARD 50 - 60 - 75 - 85, CINGOLATI C4830-C5830, CINGOLATI C6830-C7830, GHIBLI 80 - 90 - 100, GHIBLI 85 - 95 - 105, POWERFARM 60, POWERFARM 75 - 85 - 95 - 105, REX 80FP - 80GE - 80GTP, REX CAB 60, TREKKER 65F, TREKKER CF55 - CF60 - CF75	3540480M91, 3540480M92	

Art./Ref.	Note/Notes	Brand	Applicazione/Application	Rif. Orig./Orig. Ref.	Immagine/Image
<b>07898</b>	Meccanismo Frizione 11" - Luk originale/Clutch 11" - Original Luk	<b>LANDINI</b>	4530V, 5500,6500,5860,6060,6060F/L/V, 5530F/L/V,5830,6030F/L/V, 5840,6040,6840,6550,7550,8550, 6530F/L/V,6830,7530L,8830, 6870,7870,8870, 6880, 7500, 7550, 7830, 7860, 7870, 8500, 8550, 8830, 8860, 8870, ADVANTAGE 75F/FP/GE/GT/GTP/L, ADVANTAGE 75LP/V, ADVANTAGE 85F/FP/GE/GT/GTP/L, ATLANTIS 100/80/85/90, ATLAS: 100, ATLAS: 80, ATLAS: 85, ATLAS: 90, BLIZZARD 65, BLIZZARD: 75, BLIZZARD: 85, C4830,C5830,C6830,C7830, CINGOLATI:8860, CINGOLATI:C7800, FRUTTETI 530 F/L/V:7530, FRUTTETI 530 F/L/V:8530, FRUTTETI 560 F/L/V:7560, FRUTTETI 560 F/L/V:8560, GHIBLI 100/80/90, GHIBLI TIER2 105/85/95, POWER FARM: 75, POWER FARM: 85, POWERFARM 105/60/95, REX CAB E F.S: 80, REX NEW TIER 2: 75, REX NEW TIER 2: 85, TREKKER NEW TIER 2: 75, TREKKER NEW TIER 2: 85, TREKKER NEW: 70 C/F/L, TREKKER NEW: 80 C/F/L, TREKKER: CF70, TREKKER: CF75, VIGNETI CAB E F.S: 75V	3540480M91, 3540480M92	
<b>70467</b>	Disco Pto Diametro 280 mm/Pto Disc Diameter 280 mm		5500, 5830, 5840, 5860, 5860 (DAL P50187, 5870, 5870 (DAL P50187), 6030, 6040, 6060, 6060(DAL P50187), 6070, 6070 (DAL P50187), 6500, 6550, 6830, 6840, 6860, 6870, 6880, 7500, 7550, 7830, 7860, 7870, 8500, 8550, 8830, 8860, 8870, ADVANTAGE CAB E F.S:55, ADVANTAGE CAB E F.S:60, ADVANTAGE CAB E F.S:65, ADVANTAGE CAB E F.S:75, ADVANTAGE CAB E F.S:85, ATLAS:100, ATLAS:70, ATLAS:75, ATLAS:80, ATLAS:85, ATLAS:90, BLIZZARD:50, BLIZZARD:60, BLIZZARD:65, BLIZZARD:75, BLIZZARD:85, CINGOLATI: C5500, CINGOLATI: CF5830, CINGOLATI: CF6030, CINGOLATI:8860, CINGOLATI:C4500, CINGOLATI:C4830, CINGOLATI:C5830, CINGOLATI:C6500, CINGOLATI:C6830, CINGOLATI:C7800, CINGOLATI:C7830, CINGOLATI:CF4830, CINGOLATI:CF5030, CINGOLATI:CF6060, CINGOLATI:CF6830, FRUTTETI 530 F/L/V:4530, FRUTTETI 530 F/L/V:5530, FRUTTETI 530 F/L/V:6030, FRUTTETI 530 F/L/V:6530, FRUTTETI 530 F/L/V:7530, FRUTTETI 530 F/L/V:8530, FRUTTETI 560 F/L/V:5560, FRUTTETI 560 F/L/V:5560V/L, FRUTTETI 560 F/L/V:6060, FRUTTETI 560 F/L/V:6060V/L, FRUTTETI 560 F/L/V:6560, FRUTTETI 560 F/L/V:7560, FRUTTETI 560 F/L/V:8560, POWER FARM:60, POWER FARM:75, POWER FARM:85, REX CAB E FOOT STEP:60, REX CAB E FOOT STEP:70, REX CAB E FOOT STEP:80, REX NEW TIER 2:60, REX NEW TIER 2:75, REX NEW TIER 2:85, SERIE 60 NEW :6860, SERIE 60 NEW:5860, TREKKER :C75, TREKKER :CF65, TREKKER :CF70, TREKKER :CF75, TREKKER :CF85, TREKKER COMPACT TIER 2:CF60, TREKKER COMPACT TIER 2:CF70, TREKKER NEW TIER 2:75, TREKKER NEW TIER 2:85, TREKKER NEW:70C/F/L, TREKKER NEW:80C/F/L, TREKKER:CF55, TREKKER:CF60, VIGNETI CAB E FOOT STEP :55V, VIGNETI CAB E FOOT STEP :60V, VIGNETI CAB E FOOT STEP :65V, VIGNETI CAB E FOOT STEP :75V, VIGNETI CAB E FOOT STEP:75V, VIGNETI REX CAB :60V, VIGNETI REX CAB :65V., VIGNETI REX CAB TIER 2 :75V	1424135M91, 1424135M93	
<b>12841</b>	Cuscinetto reggi-spinta 90 x 50 x 21,60 mm / Thrust Bearing 90 x 50 x 21,60 mm		4530V,5530F,5530L,5530V,5830, 5500,6500,7500,8500,5860,6060, 5840,6040,6840,6550,7550,8550, 6030,6030F,6030L,6030V,6530F, 6060F/L/V,6860,7860,5860,6860, 6530L,6530V,6830,7530F,7530L, 6870,7870,8870,6880,7880,8880, 7830,8530F,8530L,8830, 7860,8860,5865,6865,7860,8865, 9880,C4830,C5830,C6830,C7830, GHIBLI 80/90/100, GHIBLI TIER2 85/95/105, GLOBALFARM 90/95/100/105, GLOBUS 55, POWERFARM 60/75/85/95/105, REX 100FP/GE/GTP, REX 60FP/GE/LP, REX 60V/65V/70V/80V, REX 70/FP/GE/GTP/LP, REX 80FP/GE/GTP/LP, REX 90FP/GE/GTP, REX CAB 60/70/80/90/100, REX TIER2 105F/GE/GT/, REX TIER2 60F/GE, REX TIER2 70F/GE, REX TIER2 75F/GE/GT, REX TIER2 80F/GE, REX TIER2 85F/GE/GT, REX TIER2 90GT, REX TIER2 95F/GE/GT, TREKKER 100C, TREKKER 105C/F/M, TREKKER 70C/F/L, TREKKER 75C/F/M, TREKKER 80C/F/L, TREKKER 85C/F/M, TREKKER 90C/F/L, TREKKER 95C/F/M, TREKKER CF60/CF70, VIGNETI 55V, VIGNETI 60V/65V/70V/80V, VIGNETI 75V	1423473M91, 1423473M93, 1423473M94, 391347X1	
<b>15757</b>	Cuscinetto pto 100 x 65 x 11 mm / Pto Bearing 100 x 65 x 11 mm		5500, 5830, 5840, 5860, 5860 (DAL P50187, 5870, 5870 (DAL P50187), 6030, 6040, 6060, 6060(DAL P50187), 6070, 6070 (DAL P50187), 6840, 6870, 6880, 7500, 7550, 7830, 7860, 7870, 7880, 8500, 8550, 8830, 8860, 8870, 8880, 9060, 9080, 9880, ADVANTAGE CAB E F.S:55, ADVANTAGE CAB E F.S:60, ADVANTAGE CAB E F.S:65, ADVANTAGE CAB E F.S:85, ADVANTAGE CAB E F.S:95, ATLANTIS 100,70,75,80,85,90, ATLAS:100, ATLAS:70, ATLAS:75, ATLAS:80, ATLAS:85, ATLAS:90, BLIZZARD:50, BLIZZARD:60, BLIZZARD:65, BLIZZARD:75, BLIZZARD:85, BLIZZARD:95, CINGOLATI: CF6030, CINGOLATI:8860, CINGOLATI:C4500, CINGOLATI:C6500, CINGOLATI:C6830, CINGOLATI:C7800, CINGOLATI:CF5030, CINGOLATI:CF6830, FRUTTETI 530 F/L/V:4530, FRUTTETI 530 F/L/V:5530, FRUTTETI 530 F/L/V:6030, FRUTTETI 530 F/L/V:6530, FRUTTETI 530 F/L/V:7530, FRUTTETI 530 F/L/V:8530, FRUTTETI 560 F/L/V:5560, FRUTTETI 560 F/L/V:5560V/L, FRUTTETI 560 F/L/V:6060, FRUTTETI 560 F/L/V:6060V/L, FRUTTETI 560 F/L/V:6560, FRUTTETI 560 F/L/V:7560, FRUTTETI 560 F/L/V:8560, GHIBLI NEW TIER 2:105, GHIBLI NEW TIER 2:85, GHIBLI NEW TIER 2:95, GHIBLI: 80, GHIBLI:90, POWER FARM:105, POWER FARM:60, POWER FARM:75, POWER FARM:85, POWER FARM:95, REX CAB E FOOT STEP: 100, REX CAB E FOOT STEP: 70, REX CAB E FOOT STEP: 80, REX CAB E FOOT STEP: 90, REX CAB E FOOT STEP:60, REX CAB E FOOT STEP:70, REX CAB E FOOT STEP:80, REX NEW TIER 2:60, REX NEW TIER 2:75, REX NEW TIER 2:85, REX TIER 2 FP/CAB:105, REX TIER 2 FP/CAB:75, REX TIER 2 FP/CAB:85, REX TIER 2 FP/CAB:95, SERIE 60 NEW :6860, SERIE 60 NEW:5860, SERIE 60 NEW:7860, SERIE 60 NEW:8860, TREKKER :CF70, TREKKER :CF75, TREKKER COMPACT TIER 2:CF60, TREKKER COMPACT TIER 2:CF70, TREKKER NEW TIER 2:105, TREKKER NEW TIER 2:75, TREKKER NEW TIER 2:85, TREKKER NEW TIER 2:95, TREKKER NEW:100C, TREKKER NEW:70 C/F/L, TREKKER NEW:70C/F/L, TREKKER NEW:80 C/F/L, TREKKER NEW:80C/F/L, TREKKER NEW:90 C/F/L, TREKKER:C75, TREKKER:C85, TREKKER:C95, VIGNETI CAB E FOOT STEP :65V, VIGNETI CAB E FOOT STEP :75V, VIGNETI CAB E FOOT STEP:65V, VIGNETI CAB E FOOT STEP:75V, VIGNETI REX CAB :65V., VIGNETI REX CAB TIER 2 :75V, VIGNETI REX CAB TIER 2:85V, VIGNETI REX CAB:70V, VIGNETI REX CAB:80V	1442381X1	

Art./Ref.	Note/Notes	Brand	Applicazione/Application	Rif. Orig./Orig. Ref.	Immagine/Image
LUK628052210	<p>Kit tutto originale LUK composto da - Kit all LUK original consists of:</p> <ul style="list-style-type: none"> <li>- Meccanismo/ Clutch Ref. 228 0003 14</li> <li>- Disco Pto/Disc Pto 328 0083 16</li> <li>- Cuscinetto/ Bearing Ref. 500 0459 00</li> <li>- Cuscinetto/ Bearing Ref. 500 1107 10</li> <li>- Cuscinetto/ Bearing Ref. 410 0042 10/</li> </ul>		<p>4530V-5530F-5530L-5530V-6030F, 5830-6030-6830-7830, 5840-6040-6840, 5860-6060-7860, 5860-8860, 6060F-6060L-6060V, 6070-6870-7870-8870, 6500-7500-8500, 6550-7550-8550, 6880-6880VM, 7530F-7530L-8830, 7880, ADVANTAGE 55F-55FP-55GE, ADVANTAGE 55GT-55GTP-55LP-55V, ADVANTAGE 60F-60FP-60GE-60GT, ADVANTAGE 60GTP-60L-60LP, ADVANTAGE 75F-75FP-75GE-75GT, ADVANTAGE 75GTP-75L-75LP-75V, ADVANTAGE 85F-85FP-85GE-85GT, ADVANTAGE 85GTP-85L-85LP, ATLAS 80 - 85 - 90 - 100, ATLATINS 80 - 85 - 90 - 100, BLIZZARD 50 - 60 - 75 - 85, CINGOLATI C4830-C5830, CINGOLATI C6830-C7830, GHIBLI 80 - 90 - 100, GHIBLI 85 - 95 - 105, POWERFARM 60, POWERFARM 75 - 85 - 95 - 105, REX 80FP - 80GE - 80GTP, REX CAB 60, TREKKER 65F, TREKKER CF55 - CF60 - CF75</p>	<p>1423473M94, 1424135M94, 1442381X1, 339599X1, 3540480M91, 3540480M92</p>	
LUK628052209	<p>Kit tutto originale LUK composto da - Kit all LUK original consists of:</p> <ul style="list-style-type: none"> <li>- Meccanismo/ Clutch Ref. 228 0003 14</li> <li>- Disco Pto/Disc Pto 328 0083 16</li> </ul>		<p>4530V-5530F-5530L-5530V-6030F, 5830-6030-6830-7830, 5840-6040-6840, 5860-6060-7860, 5860-8860, 6060F-6060L-6060V, 6070-6870-7870-8870, 6500-7500-8500, 6550-7550-8550, 6880-6880VM, 7530F-7530L-8830, 7880, ADVANTAGE 55F-55FP-55GE, ADVANTAGE 55GT-55GTP-55LP-55V, ADVANTAGE 60F-60FP-60GE-60GT, ADVANTAGE 60GTP-60L-60LP, ADVANTAGE 75F-75FP-75GE-75GT, ADVANTAGE 75GTP-75L-75LP-75V, ADVANTAGE 85F-85FP-85GE-85GT, ADVANTAGE 85GTP-85L-85LP, ATLAS 80 - 85 - 90 - 100, ATLATINS 80 - 85 - 90 - 100, BLIZZARD 50 - 60 - 75 - 85, CINGOLATI C4830-C5830, CINGOLATI C6830-C7830, GHIBLI 80 - 90 - 100, GHIBLI 85 - 95 - 105, POWERFARM 60, POWERFARM 75 - 85 - 95 - 105, REX 80FP - 80GE - 80GTP, REX CAB 60, TREKKER 65F, TREKKER CF55 - CF60 - CF75</p>	<p>1424135M94, 3540480M91, 3540480M92</p>	
LUK500045900	<p>Cuscinetto reggi-spinta 90 x 50 x 21,60 mm / Thrust Bearing 90 x 50 x 21,60 mm</p>	LANDINI	<p>4530V,5530F,5530L,5530V,5830, 5500,6500,7500,8500,5860,6060, 5840,6040,6840,6550,7550,8550, 6030,6030F,6030L,6030V,6530F, 6060F/L/V,6860,7860,5860,6860, 6530L,6530V,6830,7530F,7530L, 6870,7870,8870,6880,7880,8880, 7830,8530F,8530L,8830, 7860,8860,5865,6865,7860,8865, 9880,C4830,C5830,C6830,C7830, GHIBLI 80/90/100, GHIBLI TIER2 85/95/105, GLOBALFARM 90/95/100/105, GLOBUS 55, POWERFARM 60/75/85/95/105, REX 100FP/GE/GTP, REX 60FP/GE/LP, REX 60V/65V/70V/80V, REX 70/FP/GE/GTP/LP, REX 80FP/GE/GTP/LP, REX 90FP/GE/GTP, REX CAB 60/70/80/90/100, REX TIER2 105F/GE/GT/, REX TIER2 60F/GE, REX TIER2 70F/GE, REX TIER2 75F/GE/GT, REX TIER2 80F/GE, REX TIER2 85F/GE/GT, REX TIER2 90GT, REX TIER2 95F/GE/GT, TREKKER 100C, TREKKER 105C/F/M, TREKKER 70C/F/L, TREKKER 75C/F/M, TREKKER 80C/F/L, TREKKER 85C/F/M, TREKKER 90C/F/L, TREKKER 95C/F/M, TREKKER CF60/CF70, VIGNETI 55V, VIGNETI 60V/65V/70V/80V, VIGNETI 75V</p>	<p>1423473M91, 1423473M93, 1423473M94, 391347X1</p>	
LUK500110710	<p>Cuscinetto pto 100 x 65 x 11 mm / Pto Bearing 100 x 65 x 11 mm</p>		<p>4530V, 5500,6500,5860,6060,6060F/L/V, 5530F/L/V,5830,6030F/L/V, 5840,6040,6840,6550,7550,8550, 6530F/L/V,6830,7530L,8830, 6870,7870,8870, 6880, 7500, 7550, 7830, 7860, 7870, 8500, 8550, 8830, 8860, 8870, ADVANTAGE 75F/FP/GE/GT/GTP/L, ADVANTAGE 75LP/V, ADVANTAGE 85F/FP/GE/GT/GTP/L, ATLANTIS 100/80/85/90, ATLAS: 100, ATLAS: 80, ATLAS: 85, ATLAS: 90, BLIZZARD 65, BLIZZARD: 75, BLIZZARD: 85, C4830,C5830,C6830,C7830, CINGOLATI:8860, CINGOLATI:C7800, FRUTTETI 530 F/L/V:7530, FRUTTETI 530 F/L/V:8530, FRUTTETI 560 F/L/V:7560, FRUTTETI 560 F/L/V:8560, GHIBLI 100/80/90, GHIBLI TIER2 105/85/95, POWER FARM: 75, POWER FARM: 85, POWERFARM 105/60/95, REX CAB E F.S: 80, REX NEW TIER 2: 75, REX NEW TIER 2: 85, TREKKER NEW TIER 2: 75, TREKKER NEW TIER 2: 85, TREKKER NEW: 70 C/F/L, TREKKER NEW: 80 C/F/L, TREKKER: CF70, TREKKER: CF75, VIGNETI CAB E F.S: 75V</p>	<p>1442381X1</p>	
LUK410004210	<p>Cuscinetto volano 47 x 20 x 14 mm - Bearing 47 x 20 x 14 mm</p>		<p>4530V, 5500,6500,5860,6060,6060F/L/V, 5530F/L/V,5830,6030F/L/V, 5840,6040,6840,6550,7550,8550, 6530F/L/V,6830,7530L,8830, 6870,7870,8870, 6880, 7500, 7550, 7830, 7860, 7870, 8500, 8550, 8830, 8860, 8870, ADVANTAGE 75F/FP/GE/GT/GTP/L, ADVANTAGE 75LP/V, ADVANTAGE 85F/FP/GE/GT/GTP/L, ATLANTIS 100/80/85/90, ATLAS: 100, ATLAS: 80, ATLAS: 85, ATLAS: 90, BLIZZARD 65, BLIZZARD: 75, BLIZZARD: 85, C4830,C5830,C6830,C7830, CINGOLATI:8860, CINGOLATI:C7800, FRUTTETI 530 F/L/V:7530, FRUTTETI 530 F/L/V:8530, FRUTTETI 560 F/L/V:7560, FRUTTETI 560 F/L/V:8560, GHIBLI 100/80/90, GHIBLI TIER2 105/85/95, POWER FARM: 75, POWER FARM: 85, POWERFARM 105/60/95, REX CAB E F.S: 80, REX NEW TIER 2: 75, REX NEW TIER 2: 85, TREKKER NEW TIER 2: 75, TREKKER NEW TIER 2: 85, TREKKER NEW: 70 C/F/L, TREKKER NEW: 80 C/F/L, TREKKER: CF70, TREKKER: CF75, VIGNETI CAB E F.S: 75V</p>	<p>339599X1</p>	



Art./Ref.	Note/Notes	Brand	Applicazione/Application	Rif. Orig./Orig. Ref.	Immagine/Image
LN3540480M91	Meccanismo Frizione 11" - Landini originale/Embreyage 11" - Original Landini/Clutch 11" - Original Landini/Kupplung 11" - Landini/Embrague 11" - Original Landini	LANDINI			

**KIT FRIZIONE ADATTABILE RIF. 631064210 LANDINI**

KIT EMBRAYAGE ADAPTABLE REF. 631064210 LANDINI

KIT CLUTCH ADAPTABLE REF. 631064210 LANDINI

KIT KUPPLUNG PASSEND ZU REF. 631064210 LANDINI

KIT EMBRAGUE ADAPTABLE REF. 631064210 LANDINI

Art./Ref.	Note/Notes	Brand	Applicazione/Application	Rif. Orig./Orig. Ref.	Immagine/Image
83941	Kit composto da - Kit consists of: - Meccanismo/Clutch Ref. 3540478M92 With box Original LANDINI - Disco Pto/Disc Pto Ref. 3105233M92 Not Original - Cuscinetto/Bearing Ref. 1423473M94 Not Original - Cuscinetto/Bearing Ref. 1442381X1 Not Original	LANDINI	6560V-6860-7560-7860-7860HC, 6870-7870-8870, 6880-6880VM-7880-7880VM, 8860-8860HC-9060, 8880-8880HC-8880VM, 9080-9080HC-9880-9880HC, ADVANTAGE 65F-65FP-65GE-65GT, ADVANTAGE 65GTP-65L-65LP-65V, ADVANTAGE 75F-75FP-75GE-75GT, ADVANTAGE 75GTP-75L-75LP-75V, ADVANTAGE 85F-85FP-85GTP-85L, ADVANTAGE 85LP-85V-95GT-95GTP, ATLAS 70-75-80-85-90-100, BLIZZARD 65-75-85-95, GHIBLI 80-90-100, GHIBLI TIER 2 85-95-105, GLOBALFARM 90-95-100-105, POWERFARM MECC TIER 2 75-85, POWERFARM MECC TIER 2 95-105, REX 100FP-100GE-100GTP, REX 100V-70V-80V-85V-90V, REX 105F-105GE-105GT, REX 70FP-70GE-70GTP-70LP, REX 75F-75GE-75GT, REX 80FP-80GE-80GTP, REX 85F-85GE-85GT, REX 90FP-90GE-90GTP, REX 95F-95GE-95GT, REX CAB 70-80-90-100, TREKKER 100C-70C-70F-70L, TREKKER 65F-75F, TREKKER 80C-80F-80L-90C-90L, TREKKER C75-C85-C95, TREKKER TIER 2 105C-105F-105M, TREKKER TIER 2 85C-85F-85M, TREKKER TIER 2 95C-95F-95M, TREKKER TIER 3 100-100F-105, TREKKER TIER 3 70-75-80-85, TREKKER TIER 3 90-95, VIGNETI 65V-75V, VIGNETI FOOTSTEP 65V-75V, VIGNETI REX CAB 70V-80V, VIGNETI REX CAB TIER 2 85V	3540478M92, 6521050M91	
LN3540478M92	Meccanismo Frizione 12" - Landini originale/Clutch 12" - Original Landini		6560V-6860-7560-7860-7860HC, 6870-7870-8870, 6880-6880VM-7880-7880VM, 8860-8860HC-9060, 8880-8880HC-8880VM, 9080-9080HC-9880-9880HC, ADVANTAGE 65F-65FP-65GE-65GT, ADVANTAGE 65GTP-65L-65LP-65V, ADVANTAGE 75F-75FP-75GE-75GT, ADVANTAGE 75GTP-75L-75LP-75V, ADVANTAGE 85F-85FP-85GTP-85L, ADVANTAGE 85LP-85V-95GT-95GTP, ATLAS 70-75-80-85-90-100, BLIZZARD 65-75-85-95, GHIBLI 80-90-100, GHIBLI TIER 2 85-95-105, GLOBALFARM 90-95-100-105, POWERFARM MECC TIER 2 75-85, POWERFARM MECC TIER 2 95-105, REX 100FP-100GE-100GTP, REX 100V-70V-80V-85V-90V, REX 105F-105GE-105GT, REX 70FP-70GE-70GTP-70LP, REX 75F-75GE-75GT, REX 80FP-80GE-80GTP, REX 85F-85GE-85GT, REX 90FP-90GE-90GTP, REX 95F-95GE-95GT, REX CAB 70-80-90-100, TREKKER 100C-70C-70F-70L, TREKKER 65F-75F, TREKKER 80C-80F-80L-90C-90L, TREKKER C75-C85-C95, TREKKER TIER 2 105C-105F-105M, TREKKER TIER 2 85C-85F-85M, TREKKER TIER 2 95C-95F-95M, TREKKER TIER 3 100-100F-105, TREKKER TIER 3 70-75-80-85, TREKKER TIER 3 90-95, VIGNETI 65V-75V, VIGNETI FOOTSTEP 65V-75V, VIGNETI REX CAB 70V-80V, VIGNETI REX CAB TIER 2 85V	3540478M92, 6521050M91	
07905	Disco Pto Diametro 310 mm - Pto Disc Diameter 310 mm		6860, 6870, 6880, 7860, 7870, 7880, 8860, 8870, 8880, 9060, 9080, 9880, ADVANTAGE CAB E F.S: 65, ADVANTAGE CAB E F.S: 75, ADVANTAGE CAB E F.S: 85, ADVANTAGE CAB E F.S: 95, ATLAS: 100, ATLAS: 70, ATLAS: 75, ATLAS: 80, ATLAS: 85, ATLAS: 90, BLIZZARD: 65, BLIZZARD: 75, BLIZZARD: 85, BLIZZARD: 95, GHIBLI NEW TIER 2: 105, GHIBLI NEW TIER 2: 85, GHIBLI NEW TIER 2: 95, GHIBLI: 100, GHIBLI: 80, GHIBLI: 90, POWER FARM: 105, POWER FARM: 75, POWER FARM: 85, POWER FARM: 95, REX CAB E F.S: 100, REX CAB E F.S: 70, REX CAB E F.S: 80, REX CAB E F.S: 90, REX TIER 2 FP/CAB: 105, REX TIER 2 FP/CAB: 75, REX TIER 2 FP/CAB: 85, REX TIER 2 FP/CAB: 95, SERIE 60 NEW: 7860, SERIE 60 NEW: 8860, TREKKER NEW TIER 2: 105, TREKKER NEW TIER 2: 85, TREKKER NEW TIER 2: 95, TREKKER NEW: 100C, TREKKER NEW: 70 C/F/L, TREKKER NEW: 80 C/F/L, TREKKER NEW: 90 C/F/L, TREKKER: C75, TREKKER: C85, TREKKER: C95, VIGNETI CAB E F.S: 65V, VIGNETI CAB E F.S: 75V, VIGNETI REX CAB TIER 2: 85V, VIGNETI REX CAB: 70V, VIGNETI REX CAB: 80V	3105233M91, 3105233M92, 3311352M92	

Art./Ref.	Note/Notes	Brand	Applicazione/Application	Rif. Orig./Orig. Ref.	Immagine/Image
12841	Cuscinetto reggispinta 90 x 50 x 21,60 mm / Thrust Bearing 90 x 50 x 21,60 mm		4530V,5530F,5530L,5530V,5830, 5500,6500,7500,8500,5860,6060, 5840,6040,6840,6550,7550,8550, 6030,6030F,6030L,6030V,6530F, 6060F/L/V,6860,7860,5860,6860, 6530L,6530V,6830,7530F,7530L, 6870,7870,8870,6880,7880,8880, 7830,8530F,8530L,8830, 7860,8860,5865,6865,7860,8865, 9880,C4830,C5830,C6830,C7830, GHIBLI 80/90/100, GHIBLI TIER2 85/95/105, GLOBALFARM 90/95/100/105, GLOBUS 55, POWERFARM 60/75/85/95/105, REX 100FP/GE/GTP, REX 60FP/GE/LP, REX 60V/65V/70V/80V, REX 70/FP/GE/GTP/LP, REX 80FP/GE/GTP/LP, REX 90FP/GE/GTP, REX CAB 60/70/80/90/100, REX TIER2 105F/GE/GT/, REX TIER2 60F/GE, REX TIER2 70F/GE, REX TIER2 75F/GE/GT, REX TIER2 80F/GE, REX TIER2 85F/GE/GT, REX TIER2 90GT, REX TIER2 95F/GE/GT, TREKKER 100C, TREKKER 105C/F/M, TREKKER 70C/F/L, TREKKER 75C/F/M, TREKKER 80C/F/L, TREKKER 85C/F/M, TREKKER 90C/F/L, TREKKER 95C/F/M, TREKKER CF60/CF70, VIGNETI 55V, VIGNETI 60V/65V/70V/80V, VIGNETI 75V	1423473M91, 1423473M93, 1423473M94, 391347X1	
15757	Cuscinetto pto 100 x 65 x 11 mm / Pto Bearing 100 x 65 x 11 mm	LANDINI	5500, 5830, 5840, 5860, 5860 (DAL P50187, 5870, 5870 (DAL P50187), 6030, 6040, 6060, 6060(DAL P50187), 6070, 6070 (DAL P50187), 6840, 6870, 6880, 7500, 7550, 7830, 7860, 7870, 7880, 8500, 8550, 8830, 8860, 8870, 8880, 9060, 9080, 9880, ADVANTAGE CAB E F.S:55, ADVANTAGE CAB E F.S:60, ADVANTAGE CAB E F.S:65, ADVANTAGE CAB E F.S:85, ADVANTAGE CAB E F.S:95, ATLANTIS 100,70,75,80,85,90, ATLAS:100, ATLAS:70, ATLAS:75, ATLAS:80, ATLAS:85, ATLAS:90, BLIZZARD:50, BLIZZARD:60, BLIZZARD:65, BLIZZARD:75, BLIZZARD:85, BLIZZARD:95, CINGOLATI: CF6030, CINGOLATI:8860, CINGOLATI:C4500, CINGOLATI:C6500, CINGOLATI:C6830, CINGOLATI:C7800, CINGOLATI:CF5030, CINGOLATI:CF6830, FRUTTETI 530 F/L/V:4530, FRUTTETI 530 F/L/V:5530, FRUTTETI 530 F/L/V:6030, FRUTTETI 530 F/L/V:6530, FRUTTETI 530 F/L/V:7530, FRUTTETI 530 F/L/V:8530, FRUTTETI 560 F/L/V:5560, FRUTTETI 560 F/L/V:5560V/L, FRUTTETI 560 F/L/V:6060, FRUTTETI 560 F/L/V:6060V/L, FRUTTETI 560 F/L/V:6560, FRUTTETI 560 F/L/V:7560, FRUTTETI 560 F/L/V:8560, GHIBLI NEW TIER 2:105, GHIBLI NEW TIER 2:85, GHIBLI NEW TIER 2:95, GHIBLI: 80, GHIBLI:90, POWER FARM:105, POWER FARM:60, POWER FARM:75, POWER FARM:85, POWER FARM:95, REX CAB E FOOT STEP: 100, REX CAB E FOOT STEP: 70, REX CAB E FOOT STEP: 80, REX CAB E FOOT STEP: 90, REX CAB E FOOT STEP:60, REX CAB E FOOT STEP:70, REX CAB E FOOT STEP:80, REX NEW TIER 2:60, REX NEW TIER 2:75, REX NEW TIER 2:85, REX TIER 2 FP/CAB:105, REX TIER 2 FP/CAB:75, REX TIER 2 FP/CAB:85, REX TIER 2 FP/CAB:95, SERIE 60 NEW :6860, SERIE 60 NEW:5860, SERIE 60 NEW:7860, SERIE 60 NEW:8860, TREKKER :CF70, TREKKER :CF75, TREKKER COMPACT TIER 2:CF60, TREKKER COMPACT TIER 2:CF70, TREKKER NEW TIER 2:105, TREKKER NEW TIER 2:75, TREKKER NEW TIER 2:85, TREKKER NEW TIER 2:95, TREKKER NEW:100C, TREKKER NEW:70 C/F/L, TREKKER NEW:70C/F/L, TREKKER NEW:80 C/F/L, TREKKER NEW:80C/F/L, TREKKER NEW:90 C/F/L, TREKKER:C75, TREKKER:C85, TREKKER:C95, VIGNETI CAB E FOOT STEP :65V, VIGNETI CAB E FOOT STEP :75V, VIGNETI CAB E FOOT STEP:65V, VIGNETI CAB E FOOT STEP:75V, VIGNETI REX CAB :65V, VIGNETI REX CAB TIER 2 :75V, VIGNETI REX CAB TIER 2:85V, VIGNETI REX CAB:70V, VIGNETI REX CAB:80V	1442381X1	
85028	Kit composto da - Kit consists of: - Meccanismo/Clutch Ref. 3540478M92 With box Original LUK - Disco Pto/Disc Pto Ref. 3105233M92 Not Original - Cuscinetto/Bearing Ref. 1423473M94 Not Original - Cuscinetto/Bearing Ref. 1442381X1 Not Original	LANDINI	6560V-6860-7560-7860-7860HC, 6870-7870-8870, 6880-6880VM-7880-7880VM, 8860-8860HC-9060, 8880-8880HC-8880VM, 9080-9080HC-9880-9880HC, ADVANTAGE 65F-65FP-65GE-65GT, ADVANTAGE 65GTP-65L-65LP-65V, ADVANTAGE 75F-75FP-75GE-75GT, ADVANTAGE 75GTP-75L-75LP-75V, ADVANTAGE 85F-85FP-85GTP-85L, ADVANTAGE 85LP-85V-95GT-95GTP, ATLAS 70-75-80-85-90-100, BLIZZARD 65-75-85-95, GHIBLI 80-90-100, GHIBLI TIER 2 85-95-105, GLOBALFARM 90-95-100-105, POWERFARM MECC TIER 2 75-85, POWERFARM MECC TIER 2 95-105, REX 100FP-100GE-100GTP, REX 100V-70V-80V-85V-90V, REX 105F-105GE-105GT, REX 70FP-70GE-70GTP-70LP, REX 75F-75GE-75GT, REX 80FP-80GE-80GTP, REX 85F-85GE-85GT, REX 90FP-90GE-90GTP, REX 95F-95GE-95GT, REX CAB 70-80-90-100, TREKKER 100C-70C-70F-70L, TREKKER 65F-75F, TREKKER 80C-80F-80L-90C-90L, TREKKER C75-C85-C95, TREKKER TIER 2 105C-105F-105M, TREKKER TIER 2 85C-85F-85M, TREKKER TIER 2 95C-95F-95M, TREKKER TIER 3 100-100F-105, TREKKER TIER 3 70-75-80-85, TREKKER TIER 3 90-95, VIGNETI 65V-75V, VIGNETI FOOTSTEP 65V-75V, VIGNETI REX CAB 70V-80V, VIGNETI REX CAB TIER 2 85V	3540478M92, 6521050M91	

Art./Ref.	Note/Notes	Brand	Applicazione/Application	Rif. Orig./Orig. Ref.	Immagine/Image
<b>07903</b>	Meccanismo Frizione 12" - Luk originale/Clutch 12" - Original Luk		6560V, 6860, 6870, 6880, 7560, 7860, 7870, 7880, 8860, 8870, 8880, 9060, 9080, 9880, ADVANTAGE CAB E F.S: 65, ADVANTAGE CAB E F.S: 75, ADVANTAGE CAB E F.S: 85, ADVANTAGE CAB E F.S: 95, ATLAS: 100, ATLAS: 70, ATLAS: 75, ATLAS: 80, ATLAS: 85, ATLAS: 90, BLIZZARD: 65, BLIZZARD: 75, BLIZZARD: 85, BLIZZARD: 95, GHIBLI NEW TIER 2: 105, GHIBLI NEW TIER 2: 85, GHIBLI NEW TIER 2: 95, GHIBLI: 100, GHIBLI: 80, GHIBLI: 90, GLOBALFARM: 100, GLOBALFARM: 105, GLOBALFARM: 90, GLOBALFARM: 95, POWER FARM: 105, POWER FARM: 75, POWER FARM: 85, POWER FARM: 95, REX 70V-80V-85V-90V-100V, REX CAB E F.S: 100, REX CAB E F.S: 70, REX CAB E F.S: 80, REX CAB E F.S: 90, REX TIER 2 FP/CAB: 105, REX TIER 2 FP/CAB: 75, REX TIER 2 FP/CAB: 85, REX TIER 2 FP/CAB: 95, REX: 100FP-100GE-100GTP, REX: 70FP-70GE-70GTP-70LP, REX: 80FP-80GE-80GTP-80LP, REX: 90FP-90GE-90GTP-90LP, SERIE 60 NEW: 7860, SERIE 60 NEW: 8860, TREKKER NEW TIER 2: 105, TREKKER NEW TIER 2: 85, TREKKER NEW TIER 2: 95, TREKKER NEW TIER 3: 100, TREKKER NEW TIER 3: 105, TREKKER NEW TIER 3: 70, TREKKER NEW TIER 3: 75, TREKKER NEW TIER 3: 80, TREKKER NEW TIER 3: 85, TREKKER NEW TIER 3: 90, TREKKER NEW TIER 3: 95, TREKKER NEW: 100C, TREKKER NEW: 70 C/F/L, TREKKER NEW: 80 C/F/L, TREKKER NEW: 90 C/F/L, TREKKER: 65F, TREKKER: 75F, TREKKER: C75, TREKKER: C85, TREKKER: C95, VIGNETI CAB E F.S: 65V, VIGNETI CAB E F.S: 75V, VIGNETI REX CAB TIER 2: 85V, VIGNETI REX CAB: 70V, VIGNETI REX CAB: 80V	3540478M91, 3540478M92, 6521050M91	
<b>07905</b>	Disco Pto Diametro 310 mm - Pto Disc Diameter 310 mm		6860, 6870, 6880, 7860, 7870, 7880, 8860, 8870, 8880, 9060, 9080, 9880, ADVANTAGE CAB E F.S: 65, ADVANTAGE CAB E F.S: 75, ADVANTAGE CAB E F.S: 85, ADVANTAGE CAB E F.S: 95, ATLAS: 100, ATLAS: 70, ATLAS: 75, ATLAS: 80, ATLAS: 85, ATLAS: 90, BLIZZARD: 65, BLIZZARD: 75, BLIZZARD: 85, BLIZZARD: 95, GHIBLI NEW TIER 2: 105, GHIBLI NEW TIER 2: 85, GHIBLI NEW TIER 2: 95, GHIBLI: 100, GHIBLI: 80, GHIBLI: 90, POWER FARM: 105, POWER FARM: 75, POWER FARM: 85, POWER FARM: 95, REX CAB E F.S: 100, REX CAB E F.S: 70, REX CAB E F.S: 80, REX CAB E F.S: 90, REX TIER 2 FP/CAB: 105, REX TIER 2 FP/CAB: 75, REX TIER 2 FP/CAB: 85, REX TIER 2 FP/CAB: 95, SERIE 60 NEW: 7860, SERIE 60 NEW: 8860, TREKKER NEW TIER 2: 105, TREKKER NEW TIER 2: 85, TREKKER NEW TIER 2: 95, TREKKER NEW: 100C, TREKKER NEW: 70 C/F/L, TREKKER NEW: 80 C/F/L, TREKKER NEW: 90 C/F/L, TREKKER: C75, TREKKER: C85, TREKKER: C95, VIGNETI CAB E F.S: 65V, VIGNETI CAB E F.S: 75V, VIGNETI REX CAB TIER 2: 85V, VIGNETI REX CAB: 70V, VIGNETI REX CAB: 80V	3105233M91, 3105233M92, 3311352M92	
<b>12841</b>	Cuscinetto reggispinta 90 x 50 x 21,60 mm / Thrust Bearing 90 x 50 x 21,60 mm	<b>LANDINI</b>	4530V,5530F,5530L,5530V,5830, 5500,6500,7500,8500,5860,6060, 5840,6040,6840,6550,7550,8550, 6030,6030F,6030L,6030V,6530F, 6060F/L/V,6860,7860,5860,6860, 6530L,6530V,6830,7530F,7530L, 6870,7870,8870,6880,7880,8880, 7830,8530F,8530L,8830, 7860,8860,5865,6865,7860,8865, 9880,C4830,C5830,C6830,C7830, GHIBLI 80/90/100, GHIBLI TIER2 85/95/105, GLOBALFARM 90/95/100/105, GLOBUS 55, POWERFARM 60/75/85/95/105, REX 100FP/GE/GTP, REX 60FP/GE/LP, REX 60V/65V/70V/80V, REX 70/FP/GE/GTP/LP, REX 80FP/GE/GTP/LP, REX 90FP/GE/GTP, REX CAB 60/70/80/90/100, REX TIER2 105F/GE/GT/, REX TIER2 60F/GE, REX TIER2 70F/GE, REX TIER2 75F/GE/GT, REX TIER2 80F/GE, REX TIER2 85F/GE/GT, REX TIER2 90GT, REX TIER2 95F/GE/GT, TREKKER 100C, TREKKER 105C/F/M, TREKKER 70C/F/L, TREKKER 75C/F/M, TREKKER 80C/F/L, TREKKER 85C/F/M, TREKKER 90C/F/L, TREKKER 95C/F/M, TREKKER CF60/CF70, VIGNETI 55V, VIGNETI 60V/65V/70V/80V, VIGNETI 75V	1423473M91, 1423473M93, 1423473M94, 391347X1	
<b>15757</b>	Cuscinetto pto 100 x 65 x 11 mm / Pto Bearing 100 x 65 x 11 mm		5500, 5830, 5840, 5860, 5860 (DAL P50187, 5870, 5870 (DAL P50187), 6030, 6040, 6060, 6060 (DAL P50187), 6070, 6070 (DAL P50187), 6840, 6870, 6880, 7500, 7550, 7830, 7860, 7870, 7880, 8500, 8550, 8830, 8860, 8870, 8880, 9060, 9080, 9880, ADVANTAGE CAB E F.S:55, ADVANTAGE CAB E F.S:60, ADVANTAGE CAB E F.S:65, ADVANTAGE CAB E F.S:85, ADVANTAGE CAB E F.S:95, ATLANTIS 100,70,75,80,85,90, ATLAS:100, ATLAS:70, ATLAS:75, ATLAS:80, ATLAS:85, ATLAS:90, BLIZZARD:50, BLIZZARD:60, BLIZZARD:65, BLIZZARD:75, BLIZZARD:85, BLIZZARD:95, CINGOLATI: CF6030, CINGOLATI:8860, CINGOLATI:C4500, CINGOLATI:C6500, CINGOLATI:C6830, CINGOLATI:C7800, CINGOLATI:CF5030, CINGOLATI:CF6830, FRUTTETI 530 F/L/V:4530, FRUTTETI 530 F/L/V:5530, FRUTTETI 530 F/L/V:6030, FRUTTETI 530 F/L/V:6530, FRUTTETI 530 F/L/V:7530, FRUTTETI 530 F/L/V:8530, FRUTTETI 560 F/L/V:5560, FRUTTETI 560 F/L/V:5560V/L, FRUTTETI 560 F/L/V:6060, FRUTTETI 560 F/L/V:6060V/L, FRUTTETI 560 F/L/V:6560, FRUTTETI 560 F/L/V:7560, FRUTTETI 560 F/L/V:8560, GHIBLI NEW TIER 2:105, GHIBLI NEW TIER 2:85, GHIBLI NEW TIER 2:95, GHIBLI: 80, GHIBLI:90, POWER FARM:105, POWER FARM:60, POWER FARM:75, POWER FARM:85, POWER FARM:95, REX CAB E FOOT STEP: 100, REX CAB E FOOT STEP: 70, REX CAB E FOOT STEP: 80, REX CAB E FOOT STEP: 90, REX CAB E FOOT STEP:60, REX CAB E FOOT STEP:70, REX CAB E FOOT STEP:80, REX NEW TIER 2:60, REX NEW TIER 2:75, REX NEW TIER 2:85, REX TIER 2 FP/CAB:105, REX TIER 2 FP/CAB:75, REX TIER 2 FP/CAB:85, REX TIER 2 FP/CAB:95, SERIE 60 NEW :6860, SERIE 60 NEW:5860, SERIE 60 NEW:7860, SERIE 60 NEW:8860, TREKKER :CF70, TREKKER :CF75, TREKKER COMPACT TIER 2:CF60, TREKKER COMPACT TIER 2:CF70, TREKKER NEW TIER 2:105, TREKKER NEW TIER 2:75, TREKKER NEW TIER 2:85, TREKKER NEW TIER 2:95, TREKKER NEW:100C, TREKKER NEW:70 C/F/L, TREKKER NEW:70C/F/L, TREKKER NEW:80 C/F/L, TREKKER NEW:80C/F/L, TREKKER NEW:90 C/F/L, TREKKER: C75, TREKKER: C85, TREKKER: C95, VIGNETI CAB E FOOT STEP :65V, VIGNETI CAB E FOOT STEP :75V, VIGNETI CAB E FOOT STEP:65V, VIGNETI CAB E FOOT STEP:75V, VIGNETI REX CAB :65V, VIGNETI REX CAB TIER 2 :75V, VIGNETI REX CAB TIER 2:85V, VIGNETI REX CAB:70V, VIGNETI REX CAB:80V	1442381X1	

<p><b>LUK500115910</b></p>	<p>Cuscinetto reggispinta 94 x 50 x 22 mm / Thrust Bearing 94 x 50 x 22 mm</p>		<p>6560V-6860-7560-7860-7860HC, 6870-7870-8870, 6880-6880VM-7880-7880VM, 8860-8860HC-9060, 8880-8880HC-8880VM, 9080-9080HC-9880-9880HC, ADVANTAGE 65F-65FP-65GE-65GT, ADVANTAGE 65GTP-65L-65LP-65V, ADVANTAGE 75F-75FP-75GE-75GT, ADVANTAGE 75GTP-75L-75LP-75V, ADVANTAGE 85F-85FP-85GTP-85L, ADVANTAGE 85LP-85V-95GT-95GTP, ATLAS 70-75-80-85-90-100, BLIZZARD 65-75-85-95, GHIBLI 80-90-100, GHIBLI TIER 2 85-95-105, GLOBALFARM 90-95-100-105, POWERFARM MECC TIER 2 75-85, POWERFARM MECC TIER 2 95-105, REX 100FP-100GE-100GTP, REX 100V-70V-80V-85V-90V, REX 105F-105GE-105GT, REX 70FP-70GE-70GTP-70LP, REX 75F-75GE-75GT, REX 80FP-80GE-80GTP, REX 85F-85GE-85GT, REX 90FP-90GE-90GTP, REX 95F-95GE-95GT, REX CAB 70-80-90-100, TREKKER 100C-70C-70F-70L, TREKKER 65F-75F, TREKKER 80C-80F-80L-90C-90L, TREKKER C75-C85-C95, TREKKER TIER 2 105C-105F-105M, TREKKER TIER 2 85C-85F-85M, TREKKER TIER 2 95C-95F-95M, TREKKER TIER 3 100-100F-105, TREKKER TIER 3 70-75-80-85, TREKKER TIER 3 90-95, VIGNETI 65V-75V, VIGNETI FOOTSTEP 65V-75V, VIGNETI REX CAB 70V-80V, VIGNETI REX CAB TIER 2 85V</p>	<p>1423473M94</p>	
<p><b>LUK500110710</b></p>	<p>Cuscinetto pto 100 x 65 x 11 mm / Pto Bearing 100 x 65 x 11 mm</p>		<p>4530V, 5500,6500,5860,6060,6060F/L/V, 5530F/L/V,5830,6030F/L/V, 5840,6040,6840,6550,7550,8550, 6530F/L/V,6830,7530L,8830, 6870,7870,8870, 6880, 7500, 7550, 7830, 7860, 7870, 8500, 8550, 8830, 8860, 8870, ADVANTAGE 75F/FP/GE/GT/GTP/L, ADVANTAGE 75LP/V, ADVANTAGE 85F/FP/GE/GT/GTP/L, ATLANTIS 100/80/85/90, ATLAS: 100, ATLAS: 80, ATLAS: 85, ATLAS: 90, BLIZZARD 65, BLIZZARD: 75, BLIZZARD: 85, C4830,C5830,C6830,C7830, CINGOLATI:8860, CINGOLATI:C7800, FRUTTETI 530 F/L/V:7530, FRUTTETI 530 F/L/V:8530, FRUTTETI 560 F/L/V:7560, FRUTTETI 560 F/L/V:8560, GHIBLI 100/80/90, GHIBLI TIER2 105/85/95, POWER FARM: 75, POWER FARM: 85, POWERFARM 105/60/95, REX CAB E F.S: 80, REX NEW TIER 2: 75, REX NEW TIER 2: 85, TREKKER NEW TIER 2: 75, TREKKER NEW TIER 2: 85, TREKKER NEW: 70 C/F/L, TREKKER NEW: 80 C/F/L, TREKKER: CF70, TREKKER: CF75, VIGNETI CAB E F.S: 75V</p>	<p>1442381X1</p>	
<p><b>LUK410004210</b></p>	<p>Cuscinetto volano 47 x 20 x 14 mm - Bearing 47 x 20 x 14 mm</p>	<p><b>LANDINI</b></p>	<p>4530V, 5500,6500,5860,6060,6060F/L/V, 5530F/L/V,5830,6030F/L/V, 5840,6040,6840,6550,7550,8550, 6530F/L/V,6830,7530L,8830, 6870,7870,8870, 6880, 7500, 7550, 7830, 7860, 7870, 8500, 8550, 8830, 8860, 8870, ADVANTAGE 75F/FP/GE/GT/GTP/L, ADVANTAGE 75LP/V, ADVANTAGE 85F/FP/GE/GT/GTP/L, ATLANTIS 100/80/85/90, ATLAS: 100, ATLAS: 80, ATLAS: 85, ATLAS: 90, BLIZZARD 65, BLIZZARD: 75, BLIZZARD: 85, C4830,C5830,C6830,C7830, CINGOLATI:8860, CINGOLATI:C7800, FRUTTETI 530 F/L/V:7530, FRUTTETI 530 F/L/V:8530, FRUTTETI 560 F/L/V:7560, FRUTTETI 560 F/L/V:8560, GHIBLI 100/80/90, GHIBLI TIER2 105/85/95, POWER FARM: 75, POWER FARM: 85, POWERFARM 105/60/95, REX CAB E F.S: 80, REX NEW TIER 2: 75, REX NEW TIER 2: 85, TREKKER NEW TIER 2: 75, TREKKER NEW TIER 2: 85, TREKKER NEW: 70 C/F/L, TREKKER NEW: 80 C/F/L, TREKKER: CF70, TREKKER: CF75, VIGNETI CAB E F.S: 75V</p>	<p>339599X1</p>	
<p><b>LN3540478M92</b></p>	<p>Meccanismo Frizione 12" - Landini originale/Clutch 12" - Original Landini</p>		<p>6560V-6860-7560-7860-7860HC, 6870-7870-8870, 6880-6880VM-7880-7880VM, 8860-8860HC-9060, 8880-8880HC-8880VM, 9080-9080HC-9880-9880HC, ADVANTAGE 65F-65FP-65GE-65GT, ADVANTAGE 65GTP-65L-65LP-65V, ADVANTAGE 75F-75FP-75GE-75GT, ADVANTAGE 75GTP-75L-75LP-75V, ADVANTAGE 85F-85FP-85GTP-85L, ADVANTAGE 85LP-85V-95GT-95GTP, ATLAS 70-75-80-85-90-100, BLIZZARD 65-75-85-95, GHIBLI 80-90-100, GHIBLI TIER 2 85-95-105, GLOBALFARM 90-95-100-105, POWERFARM MECC TIER 2 75-85, POWERFARM MECC TIER 2 95-105, REX 100FP-100GE-100GTP, REX 100V-70V-80V-85V-90V, REX 105F-105GE-105GT, REX 70FP-70GE-70GTP-70LP, REX 75F-75GE-75GT, REX80FP-80GE-80GTP, REX 85F-85GE-85GT, REX 90FP-90GE-90GTP, REX 95F-95GE-95GT, REX CAB 70-80-90-100, TREKKER 100C-70C-70F-70L, TREKKER 65F-75F, TREKKER 80C-80F-80L-90C-90L, TREKKER C75-C85-C95, TREKKER TIER 2 105C-105F-105M, TREKKER TIER 2 85C-85F-85M, TREKKER TIER 2 95C-95F-95M, TREKKER TIER 3 100-100F-105, TREKKERTIER 3 70-75-80-85, TREKKER TIER 3 90-95, VIGNETI 65V-75V, VIGNETI FOOTSTEP 65V-75V, VIGNETI REX CAB 70V-80V, VIGNETI REX CAB TIER 2 85V</p>		

**MECCANISMO + DISCO PTO ORIGINALE LUK RIF. 631064216**

MECANISME + DISQUE PTO ORIGINAL LUK 631064216

COVER ASSEMBLY + ORIGINAL PTO DISC LUK REF. 631064216

GETRIEBE + ZAPFWELLENSCHEIBE LUK 631064216

MECANISMO + DISCO PTO ORIGINAL LUK REF. 631064216

Art./Ref.	Note/Notes	Brand	Applicazione/Application	Rif. Orig./Orig. Ref.	Immagine/Image
<b>LUK500115910</b>	Cuscinetto reggispinta 94 x 50 x 22 mm / Thrust Bearing 94 x 50 x 22 mm	<b>LANDINI</b>	6560V-6860-7560-7860-7860HC, 6870-7870-8870, 6880-6880VM-7880-7880VM, 8860-8860HC-9060, 8880-8880HC-8880VM, 9080-9080HC-9880-9880HC, ADVANTAGE 65F-65FP-65GE-65GT, ADVANTAGE 65GTP-65L-65LP-65V, ADVANTAGE 75F-75FP-75GE-75GT, ADVANTAGE 75GTP-75L-75LP-75V, ADVANTAGE 85F-85FP-85GTP-85L, ADVANTAGE 85LP-85V-95GT-95GTP, ATLAS 70-75-80-85-90-100, BLIZZARD 65-75-85-95, GHIBLI 80-90-100, GHIBLI TIER 2 85-95-105, GLOBALFARM 90-95-100-105, POWERFARM MECC TIER 2 75-85, POWERFARM MECC TIER 2 95-105, REX 100FP-100GE-100GTP, REX 100V-70V-80V-85V-90V, REX 105F-105GE-105GT, REX 70FP-70GE-70GTP-70LP, REX 75F-75GE-75GT, REX 80FP-80GE-80GTP, REX 85F-85GE-85GT, REX 90FP-90GE-90GTP, REX 95F-95GE-95GT, REX CAB 70-80-90-100, TREKKER 100C-70C-70F-70L, TREKKER 65F-75F, TREKKER 80C-80F-80L-90C-90L, TREKKER C75-C85-C95, TREKKER TIER 2 105C-105F-105M, TREKKER TIER 2 85C-85F-85M, TREKKER TIER 2 95C-95F-95M, TREKKER TIER 3 100-100F-105, TREKKER TIER 3 70-75-80-85, TREKKER TIER 3 90-95, VIGNETI 65V-75V, VIGNETI FOOTSTEP 65V-75V, VIGNETI REX CAB 70V-80V, VIGNETI REX CAB TIER 2 85V	1423473M94	
<b>LUK500110710</b>	Cuscinetto pto 100 x 65 x 11 mm / Pto Bearing 100 x 65 x 11 mm		4530V, 5500, 6500, 5860, 6060, 6060F/L/V, 5530F/L/V, 5830, 6030F/L/V, 5840, 6040, 6840, 6550, 7550, 8550, 6530F/L/V, 6830, 7530L, 8830, 6870, 7870, 8870, 6880, 7500, 7550, 7830, 7860, 7870, 8500, 8550, 8830, 8860, 8870, ADVANTAGE 75F/FP/GE/GT/GTP/L, ADVANTAGE 75LP/V, ADVANTAGE 85F/FP/GE/GT/GTP/L, ATLANTIS 100/80/85/90, ATLAS: 100, ATLAS: 80, ATLAS: 85, ATLAS: 90, BLIZZARD 65, BLIZZARD: 75, BLIZZARD: 85, C4830, C5830, C6830, C7830, CINGOLATI: 8860, CINGOLATI: C7800, FRUTTETI 530 F/L/V: 7530, FRUTTETI 530 F/L/V: 8530, FRUTTETI 560 F/L/V: 7560, FRUTTETI 560 F/L/V: 8560, GHIBLI 100/80/90, GHIBLI TIER2 105/85/95, POWER FARM: 75, POWER FARM: 85, POWERFARM 105/60/95, REX CAB E F.S: 80, REX NEW TIER 2: 75, REX NEW TIER 2: 85, TREKKER NEW TIER 2: 75, TREKKER NEW TIER 2: 85, TREKKER NEW: 70 C/F/L, TREKKER NEW: 80 C/F/L, TREKKER: CF70, TREKKER: CF75, VIGNETI CAB E F.S: 75V	1442381X1	
<b>LUK410004210</b>	Cuscinetto volano 47 x 20 x 14 mm - Bearing 47 x 20 x 14 mm / Cuscinetto volano 47 x 20 x 14 mm - Bearing 47 x 20 x 14 mm / Cuscinetto volano 47 x 20 x 14 mm - Bearing 47 x 20 x 14 mm / Cuscinetto volano 47 x 20 x 14 mm - Bearing 47 x 20 x 14 mm / Cuscinetto volano 47 x 20 x 14 mm - Bearing 47 x 20 x 14 mm		4530V, 5500, 6500, 5860, 6060, 6060F/L/V, 5530F/L/V, 5830, 6030F/L/V, 5840, 6040, 6840, 6550, 7550, 8550, 6530F/L/V, 6830, 7530L, 8830, 6870, 7870, 8870, 6880, 7500, 7550, 7830, 7860, 7870, 8500, 8550, 8830, 8860, 8870, ADVANTAGE 75F/FP/GE/GT/GTP/L, ADVANTAGE 75LP/V, ADVANTAGE 85F/FP/GE/GT/GTP/L, ATLANTIS 100/80/85/90, ATLAS: 100, ATLAS: 80, ATLAS: 85, ATLAS: 90, BLIZZARD 65, BLIZZARD: 75, BLIZZARD: 85, C4830, C5830, C6830, C7830, CINGOLATI: 8860, CINGOLATI: C7800, FRUTTETI 530 F/L/V: 7530, FRUTTETI 530 F/L/V: 8530, FRUTTETI 560 F/L/V: 7560, FRUTTETI 560 F/L/V: 8560, GHIBLI 100/80/90, GHIBLI TIER2 105/85/95, POWER FARM: 75, POWER FARM: 85, POWERFARM 105/60/95, REX CAB E F.S: 80, REX NEW TIER 2: 75, REX NEW TIER 2: 85, TREKKER NEW TIER 2: 75, TREKKER NEW TIER 2: 85, TREKKER NEW: 70 C/F/L, TREKKER NEW: 80 C/F/L, TREKKER: CF70, TREKKER: CF75, VIGNETI CAB E F.S: 75V	339599X1	

**MECCANISMO + DISCO PTO ORIGINALE LUK RIF. 633052319**





MECANISME + DISQUE PTO ORIGINAL LUK 633052319

COVER ASSEMBLY + ORIGINAL PTO DISC LUK REF. 633052319

GETRIEBE + ZAPFWELLENSCHEIBE LUK 633052319



MECANISMO + DISCO PTO ORIGINAL LUK REF. 633052319

Art./Ref.	Note/Notes	Brand	Applicazione/Application	Rif. Orig./Orig. Ref.	Immagine/Image
<b>LUK633052319</b>	Kit tutto originale LUK composto da - Kit all LUK original consists of: - Meccanismo/Clutch Ref. 233 0020 12 - Disco Pto/Disc Pto 333 0019 16	<b>LANDINI</b>	10000, 10000S, 12500, 13000, 14500	1426390M94, 3540481M91	

Art./Ref.	Note/Notes	Brand	Applicazione/Application	Rif. Orig./Orig. Ref.	Immagine/Image
<b>07906</b>	Meccanismo Frizione 13" - Luk originale/Clutch 13" - Original Luk	<b>LANDINI</b>	10000, 10000S, 12500, 13000, 14500	3540481M91	
<b>07908</b>	Disco Pto Diametro 330 mm/Pto Disc Diameter 330 mm		10000, 10000S, 12500, 13000, 14500	1426390M93, 1426390M94	
<b>59850</b>	Cuscinetto reggispinta 92 x 55 x 31 mm / Thrust Bearing 92 x 55 x 31 mm		10000, 10000S(->22900804), 12500, 13000, 14500	3302143M91	
<b>70427</b>	Cuscinetto pto 115 x 75 x 13 mm / Pto Bearing 115 x 75 x 13 mm		10000, 10000S, 12500, 13000, 14500	392191X1	
<b>70433</b>	Cuscinetto volano 52 x 25 x 18 mm/Bearing 52 x 25 x 18 mm		10000, 10000S, 12500, 13000, 14500, LEGEND N/G TDI:125, LEGEND N/G TDI:135, LEGEND N/G TDI:145, LEGEND N/G-TDI :165, LEGEND N/G-TDI :185, LEGEND N/G:115, LEGEND N/G:120, LEGEND N/G:130, LEGEND N/G:140, LEGEND N/G:160, LEGEND N/G:180, LEGEND:105, LEGEND:115, LEGEND:130, LEGEND:145, LEGEND:165	392168X1	



**MECCANISMO + DISCO AVANZAMENTO ORIGINALE LUK RIF. 635211609**

MECANISME + DISQUE AVANCEMENT ORIGINAL LUK 635211609  
 COVER ASSEMBLY + ORIGINAL MAIN DRIVE LUK REF. 635211609  
 GETRIEBE + VORSCHLEIBE LUK 635211609  
 MECCANISMO + DISCO DE AVANCE ORIGINAL LUK REF. 635211609

Art./Ref.	Note/Notes	Brand	Applicazione/Application	Rif. Orig./Orig. Ref.	Immagine/Image
<b>70853</b>	Kit tutto originale LUK composto da - Kit all LUK original consists of: - Meccanismo/Clutch Ref. 135 0243 11 - Disco avanzamento/Disc 335 0191 10 0	<b>LANDINI</b>	LANDPOWER 125, LANDPOWER 135, LANDPOWER 145, LEGEND 105 TOP, LEGEND 115 TOP, LEGEND 120 TOP, LEGEND 130 TOP, LEGEND 140 TOP, LEGEND 145 TOP, LEGEND 165 TOP	3559802M91	
<b>70433</b>	Cuscinetto volano 52 x 25 x 18 mm/Bearing 52 x 25 x 18 mm		10000, 10000S, 12500, 13000, 14500, LEGEND N/G TDI:125, LEGEND N/G TDI:135, LEGEND N/G TDI:145, LEGEND N/G-TDI :165, LEGEND N/G-TDI :185, LEGEND N/G:115, LEGEND N/G:120, LEGEND N/G:130, LEGEND N/G:140, LEGEND N/G:160, LEGEND N/G:180, LEGEND:105, LEGEND:115, LEGEND:130, LEGEND:145, LEGEND:165	392168X1	

**MECCANISMO + DISCO PTO ORIGINALE LUK RIF. 635238409**

MECANISME + DISQUE PTO ORIGINAL LUK 635238409  
 COVER ASSEMBLY + ORIGINAL PTO DISC LUK REF. 635238409  
 GETRIEBE + ZAPFWELLENSCHEIBE LUK 635238409  
 MECCANISMO + DISCO PTO ORIGINAL LUK REF. 635238409

Art./Ref.	Note/Notes	Brand	Applicazione/Application	Rif. Orig./Orig. Ref.	Immagine/Image
<b>70854</b>	Kit tutto originale LUK composto da - Kit all LUK original consists of: - Meccanismo/Clutch Ref. 235 0027 10 - Disco Pto/Disc Pto 335 0194 10	<b>LANDINI</b>	LANDPOWER 140, LANDPOWER 160, LANDPOWER 165, LEGEND 160 TOP, LEGEND 165 TECHNO	3559804M91	
<b>70433</b>	Cuscinetto volano 52 x 25 x 18 mm/Bearing 52 x 25 x 18 mm		10000, 10000S, 12500, 13000, 14500, LEGEND N/G TDI:125, LEGEND N/G TDI:135, LEGEND N/G TDI:145, LEGEND N/G-TDI :165, LEGEND N/G-TDI :185, LEGEND N/G:115, LEGEND N/G:120, LEGEND N/G:130, LEGEND N/G:140, LEGEND N/G:160, LEGEND N/G:180, LEGEND:105, LEGEND:115, LEGEND:130, LEGEND:145, LEGEND:165	392168X1	



**MECCANISMO + DISCO PTO ORIGINALE LUK RIF. 623306509**

MECANISME + DISQUE PTO ORIGINAL LUK 623306509

COVER ASSEMBLY + ORIGINAL PTO DISC LUK REF. 623306509

GETRIEBE + ZAPFWELLENSCHEIBE LUK 623306509

MECANISMO + DISCO PTO ORIGINAL LUK REF. 623306509

Art./Ref.	Note/Notes	Brand	Applicazione/Application	Rif. Orig./Orig. Ref.	Immagine/Image
<b>LUK623306509</b>	Kit tutto originale LUK composto da - Kit all LUK original consists of: - Meccanismo/Clutch Ref. 223 0028 10 - Disco Pto/Disc Pto 323 0471 10	<b>LANDINI</b>	MISTRAL 40, MISTRAL 45, MISTRAL 50, MISTRAL 55	4202165M91, 6510438M91	
<b>LUK500045900</b>	Cuscinetto reggispinta 90 x 50 x 21,60 mm / Thrust Bearing 90 x 50 x 21,60 mm		4530V,5530F,5530L,5530V,5830, 5500,6500,7500,8500,5860,6060, 5840,6040,6840,6550,7550,8550, 6030,6030F,6030L,6030V,6530F, 6060F/L/V,6860,7860,5860,6860, 6530L,6530V,6830,7530F,7530L, 6870,7870,8870,6880,7880,8880, 7830,8530F,8530L,8830, 7860,8860,5865,6865,7860,8865, 9880,C4830,C5830,C6830,C7830, GHIBLI 80/90/100, GHIBLI TIER2 85/95/105, GLOBALFARM 90/95/100/105, GLOBUS 55, POWERFARM 60/75/85/95/105, REX 100FP/GE/GTP, REX 60FP/GE/LP, REX 60V/65V/70V/80V, REX 70/FP/GE/GTP/LP, REX 80FP/GE/GTP/LP, REX 90FP/GE/GTP, REX CAB 60/70/80/90/100, REX TIER2 105F/GE/GT/, REX TIER2 60F/GE, REX TIER2 70F/GE, REX TIER2 75F/GE/GT, REX TIER2 80F/GE, REX TIER2 85F/GE/GT, REX TIER2 90GT, REX TIER2 95F/GE/GT, TREKKER 100C, TREKKER 105C/F/M, TREKKER 70C/F/L, TREKKER 75C/F/M, TREKKER 80C/F/L, TREKKER 85C/F/M, TREKKER 90C/F/L, TREKKER 95C/F/M, TREKKER CF60/CF70, VIGNETI 55V, VIGNETI 60V/65V/70V/80V, VIGNETI 75V	1423473M91, 1423473M93, 1423473M94, 391347X1	
<b>LUK500067300</b>	Cuscinetto pto 100 x 65 x 18 mm / Pto Bearing 100 x 65 x 18 mm		MISTRAL 40, MISTRAL 45, MISTRAL 50, MISTRAL 55	390947X1	



**KIT FRIZIONE ADATTABILE RIF. 628052210 MCCORMICK**

KIT EMBRAYAGE ADAPTABLE REF. 628052210 MCCORMICK

KIT CLUTCH ADAPTABLE REF. 628052210 MCCORMICK





KIT KUPPLUNG PASSEND ZU REF. 628052210 MCCORMICK

KIT EMBRAGUE ADAPTABLE REF. 628052210 MCCORMICK

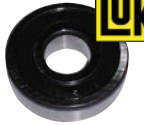

Art./Ref.	Note/Notes	Brand	Applicazione/Application	Rif. Orig./Orig. Ref.	Immagine/Image
<b>83940</b>	Kit composto da - Kit consists of: - Meccanismo/Clutch Ref. 3540480M92 With box Original LANDINI - Disco Pto/Disc Pto Ref. 1424135M93 Not Original - Cuscinetto/Bearing Ref. 1423473M94 Not Original - Cuscinetto/Bearing Ref. 1442381X1 Not Original	<b>MCCORMICK</b>	C75MAX, C80MAX, C85MAX, CLASSIC 353, F75, F80, F85, T100, T70, T80, T90	3540480M91, 3540480M92	
<b>LN3540480M91</b>	Meccanismo Frizione 11" - Landini originale/ Clutch 11" - Original Landini		C75MAX, C80MAX, C85MAX, CLASSIC 353, F75, F80, F85, T100, T70, T80, T90	3540480M91, 3540480M92	

Art./Ref.	Note/Notes	Brand	Applicazione/Application	Rif. Orig./Orig. Ref.	Immagine/Image
<b>70467</b>	Disco Pto Diametro 280 mm/Pto Disc Diameter 280 mm	<b>MCCORMICK</b>	F60,F70,F75,F80,F85, T100,T70,T90, V60,V65,V70,V80	1424135M93	
<b>12841</b>	Cuscinetto reggispinta 90 x 50 x 21,60 mm / Thrust Bearing 90 x 50 x 21,60 mm		F60,F70,F75,F80,F85, T100,T70,T80,T90, V60,V65,V70,V80	1423473M93, 1966557C1	
<b>15757</b>	Cuscinetto pto 100 x 65 x 11 mm / Pto Bearing 100 x 65 x 11 mm		F90,F95, T100,T70,T80,T90, V60,V65,V70,V80	1442381X1	
<b>85025</b>	Kit composto da - Kit consists of: - Meccanismo/Clutch Ref. 3540480M92 With box Original LUK - Disco Pto/Disc Pto Ref. 1424135M93 Not Original - Cuscinetto/Bearing Ref. 1423473M94 Not Original - Cuscinetto/Bearing Ref. 1442381X1 Not Original	<b>MCCORMICK</b>	C75MAX, C80MAX, C85MAX, CLASSIC 353, F75, F80, F85, T100, T70, T80, T90	3540480M91, 3540480M92	   
<b>07898</b>	Meccanismo Frizione 11" - Luk originale/ Clutch 11" - Original Luk		353, C75MAX,C80MAX,C85MAX, F75,F80,F85, T100,T70,T80,T90	3540480M91, 3540480M92	
<b>70467</b>	Disco Pto Diametro 280 mm/Pto Disc Diameter 280 mm		F60,F70,F75,F80,F85, T100,T70,T90, V60,V65,V70,V80	1424135M93	
<b>12841</b>	Cuscinetto reggispinta 90 x 50 x 21,60 mm / Thrust Bearing 90 x 50 x 21,60 mm		F60,F70,F75,F80,F85, T100,T70,T80,T90, V60,V65,V70,V80	1423473M93, 1966557C1	
<b>15757</b>	Cuscinetto pto 100 x 65 x 11 mm / Pto Bearing 100 x 65 x 11 mm		F100,F105,F60,F70,F75,F80,F85, F90,F95, T100,T70,T80,T90, V60,V65,V70,V80	1442381X1	
<b>LUK628052210</b>	Kit tutto originale LUK composto da - Kit all LUK original consists of: - Meccanismo/Clutch Ref. 228 0003 14 - Disco Pto/Disc Pto 328 0083 16 - Cuscinetto/Bearing Ref. 500 0459 00 - Cuscinetto/Bearing Ref. 500 1107 10 - Cuscinetto/Bearing Ref. 410 0042 10		<b>MCCORMICK</b>	C75MAX, C80MAX, C85MAX, CLASSIC 353, F75, F80, F85, T100, T70, T80, T90	1423473M94, 1424135M94, 1442381X1, 339599X1, 3540480M91, 3540480M92



Art./Ref.	Note/Notes	Brand	Applicazione/Application	Rif. Orig./Orig. Ref.	Immagine/Image
<b>LUK628052209</b>	Kit tutto originale LUK composto da - Kit all LUK original consists of: - Meccanismo/Clutch Ref. 228 0003 14 - Disco Pto/Disc Pto 328 0083 16	<b>MCCORMICK</b>	C75MAX, C80MAX, C85MAX, CLASSIC 353, F75, F80, F85, T100, T70, T80, T90	1424135M94, 3540480M91, 3540480M92	
<b>LUK500045900</b>	Cuscinetto reggispinta 90 x 50 x 21,60 mm / Thrust Bearing 90 x 50 x 21,60 mm		F60,F70,F75,F80,F85, T100,T70,T80,T90, V60,V65,V70,V80	1423473M93, 1966557C1	
<b>LUK500110710</b>	Cuscinetto pto 100 x 65 x 11 mm / Pto Bearing 100 x 65 x 11 mm		353, C75MAX,C80MAX,C85MAX, F75,F80,F85, T100,T70,T80,T90	1442381X1	
<b>LUK410004210</b>	Cuscinetto volano 47 x 20 x 14 mm - Bearing 47 x 20 x 14 mm		353, C75MAX,C80MAX,C85MAX, F75,F80,F85, T100,T70,T80,T90	339599X1	
<b>LN3540480M91</b>	Meccanismo Frizione 11" - Landini originale/ Clutch 11" - Original Landini				

**KIT FRIZIONE ADATTABILE RIF. 631064210 MCCORMICK**
*KIT EMBRAYAGE ADAPTABLE REF. 631064210 MCCORMICK*
*KIT CLUTCH ADAPTABLE REF. 631064210 MCCORMICK*
*KIT KUPPLUNG PASSEND ZU REF. 631064210 MCCORMICK*
*KIT EMBRAGUE ADAPTABLE REF. 631064210 MCCORMICK*

Art./Ref.	Note/Notes	Brand	Applicazione/Application	Rif. Orig./Orig. Ref.	Immagine/Image
<b>83941</b>	Kit composto da - Kit consists of: - Meccanismo/Clutch Ref. 3540478M92 With box Original LANDINI - Disco Pto/Disc Pto Ref. 3105233M92 Not Original - Cuscinetto/Bearing Ref. 1423473M94 Not Original - Cuscinetto/Bearing Ref. 1442381X1 Not Original	<b>MCCORMICK</b>	C 105 MAX - C 110 MAX, C 75 MAX - C 80 MAX, C 85 MAX - C 90 MAX, C 95 MAX, F 100 GT, F 105 F-GE-XL, F 90 GT, F 95 F-GE-XL, T 70 - T 80 - T 90 - T 100, V 70 - V 80	3540478M92, 6521050M91	
<b>LN3540478M92</b>	Meccanismo Frizione 12" - Landini originale/ Clutch 12" - Original Landini		C 105 MAX - C 110 MAX, C 75 MAX - C 80 MAX, C 85 MAX - C 90 MAX, C 95 MAX, F 100 GT, F 105 F-GE-XL, F 90 GT, F 95 F-GE-XL, T 70 - T 80 - T 90 - T 100, V 70 - V 80	3540478M92, 6521050M91	
<b>07905</b>	Disco Pto Diametro 310 mm/Pto Disc Diameter 310 mm		C 105 MAX - C 110 MAX, C 75 MAX - C 80 MAX, C 85 MAX - C 90 MAX, C 95 MAX, F 100 GT, F 105 F-GE-XL, F 90 GT, F 95 F-GE-XL, T 70 - T 80 - T 90 - T 100, V 70 - V 80	3105233M91, 3105233M92, 3311352M92	

Art./Ref.	Note/Notes	Brand	Applicazione/Application	Rif. Orig./Orig. Ref.	Immagine/Image
12841	Cuscinetto reggispinta 90 x 50 x 21,60 mm / Thrust Bearing 90 x 50 x 21,60 mm	MCCORMICK	F60,F70,F75,F80,F85, T100,T70,T80,T90, V60,V65,V70,V80	1423473M93, 1966557C1	
15757	Cuscinetto pto 100 x 65 x 11 mm / Pto Bearing 100 x 65 x 11 mm		F100,F105,F60,F70,F75,F80,F85, F90,F95, T100,T70,T80,T90, V60,V65,V70,V80	1442381X1	
85028	Kit composto da - Kit consists of: - Meccanismo/Clutch Ref. 3540478M92 With box Original LUK - Disco Pto/Disc Pto Ref. 3105233M92 Not Original - Cuscinetto/Bearing Ref. 1423473M94 Not Original - Cuscinetto/Bearing Ref. 1442381X1 Not Original	MCCORMICK	C 105 MAX - C 110 MAX, C 75 MAX - C 80 MAX, C 85 MAX - C 90 MAX, C 95 MAX, F 100 GT, F 105 F-GE-XL, F 90 GT, F 95 F-GE-XL, T 70 - T 80 - T 90 - T 100, V 70 - V 80	3540478M92, 6521050M91	   
07903	Meccanismo Frizione 12" - Luk originale// Clutch 12" - Original Luk		C 105 MAX - C 110 MAX, C 75 MAX - C 80 MAX, C 85 MAX - C 90 MAX, C 95 MAX, F 100 GT, F 105 F-GE-XL, F 90 GT, F 95 F-GE-XL, T 70 - T 80 - T 90 - T 100, V 70 - V 80	3540478M92, 6521050M91	
07905	Disco Pto Diametro 310 mm/Pto Disc Diameter 310 mm		C 105 MAX - C 110 MAX, C 75 MAX - C 80 MAX, C 85 MAX - C 90 MAX, C 95 MAX, F 100 GT, F 105 F-GE-XL, F 90 GT, F 95 F-GE-XL, T 70 - T 80 - T 90 - T 100, V 70 - V 80	3105233M91, 3105233M92, 3311352M92	
12841	Cuscinetto reggispinta 90 x 50 x 21,60 mm / Thrust Bearing 90 x 50 x 21,60 mm		F60,F70,F75,F80,F85, T100,T70,T80,T90, V60,V65,V70,V80	1423473M93, 1966557C1	
15757	Cuscinetto pto 100 x 65 x 11 mm / Pto Bearing 100 x 65 x 11 mm		F100,F105,F60,F70,F75,F80,F85, F90,F95, T100,T70,T80,T90, V60,V65,V70,V80	1442381X1	
LUK500115910	Cuscinetto reggispinta 94 x 50 x 22 mm / Thrust Bearing 94 x 50 x 22 mm		C 105 MAX - C 110 MAX, C 75 MAX - C 80 MAX, C 85 MAX - C 90 MAX, C 95 MAX, F 100 GT, F 105 F-GE-XL, F 90 GT, F 95 F-GE-XL, T 70 - T 80 - T 90 - T 100, V 70 - V 80	1423473M94	
LUK500110710	Cuscinetto pto 100 x 65 x 11 mm / Pto Bearing 100 x 65 x 11 mm	353, C75MAX,C80MAX,C85MAX, F75,F80,F85, T100,T70,T80,T90	1442381X1		
LUK410004210	Cuscinetto volano 47 x 20 x 14 mm - Bearing 47 x 20 x 14 mm	353, C75MAX,C80MAX,C85MAX, F75,F80,F85, T100,T70,T80,T90	339599X1		
LN3540478M92	Meccanismo Frizione 12" - Landini originale/ Clutch 12" - Original Landini				



**MECCANISMO + DISCO PTO ORIGINALE LUK RIF. 631064216**

MECANISME + DISQUE PTO ORIGINAL LUK 631064216

COVER ASSEMBLY + ORIGINAL PTO DISC LUK REF. 631064216

GETRIEBE + ZAPFWELLENSCHEIBE LUK 631064216

MECANISMO + DISCO PTO ORIGINAL LUK REF. 631064216

Art./Ref.	Note/Notes	Brand	Applicazione/Application	Rif. Orig./Orig. Ref.	Immagine/Image
<b>LUK500115910</b>	Cuscinetto reggispinta 94 x 50 x 22 mm / Thrust Bearing 94 x 50 x 22 mm	<b>MCCORMICK</b>	C 105 MAX - C 110 MAX, C 75 MAX - C 80 MAX, C 85 MAX - C 90 MAX, C 95 MAX, F 100 GT, F 105 F-GE-XL, F 90 GT, F 95 F-GE-XL, T 70 - T 80 - T 90 - T 100, V 70 - V 80	1423473M94	
<b>LUK500110710</b>	Cuscinetto pto 100 x 65 x 11 mm / Pto Bearing 100 x 65 x 11 mm		353, C75MAX, C80MAX, C85MAX, F75, F80, F85, T100, T70, T80, T90	1442381X1	
<b>LUK410004210</b>	Cuscinetto volano 47 x 20 x 14 mm - Bearing 47 x 20 x 14 mm		353, C75MAX, C80MAX, C85MAX, F75, F80, F85, T100, T70, T80, T90	339599X1	



**MECCANISMO + DISCO PTO ORIGINALE LUK RIF. 623306509**

MECANISME + DISQUE PTO ORIGINAL LUK 623306509

COVER ASSEMBLY + ORIGINAL PTO DISC LUK REF. 623306509

GETRIEBE + ZAPFWELLENSCHEIBE LUK 623306509

MECANISMO + DISCO PTO ORIGINAL LUK REF. 623306509

Art./Ref.	Note/Notes	Brand	Applicazione/Application	Rif. Orig./Orig. Ref.	Immagine/Image
<b>LUK623306509</b>	Kit tutto originale LUK composto da - Kit all LUK original consists of: - Meccanismo/Clutch Ref. 223 0028 10 - Disco Pto/Disc Pto 323 0471 10	<b>MCCORMICK</b>	GM 40 - 45 - 50 - 55, GX 40 - 40 H, GX 45 - 45 H, GX 50 - 50 H, GX 55 - 55 H	4202165M91, 6510438M91	
<b>LUK500045900</b>	Cuscinetto reggispinta 90 x 50 x 21,60 mm / Thrust Bearing 90 x 50 x 21,60 mm		F60, F70, F75, F80, F85, T100, T70, T80, T90, V60, V65, V70, V80	1423473M93, 1966557C1	
<b>LUK500067300</b>	Cuscinetto pto 100 x 65 x 18 mm / Pto Bearing 100 x 65 x 18 mm		GM 40 - 45 - 50 - 55, GX 40 - 40 H, GX 45 - 45 H, GX 50 - 50 H, GX 55 - 55 H	390947X1	

**KIT FRIZIONE ADATTABILE RIF. 628052210 MASSEY FERGUSON**





KIT EMBRAYAGE ADAPTABLE REF. 628052210 MASSEY FERGUSON

KIT CLUTCH ADAPTABLE REF. 628052210 MASSEY FERGUSON

KIT KUPPLUNG PASSEND ZU REF. 628052210 MASSEY FERGUSON

KIT EMBRAGUE ADAPTABLE REF. 628052210 MASSEY FERGUSON

Art./Ref.	Note/Notes	Brand	Applicazione/Application	Rif. Orig./Orig. Ref.	Immagine/Image
<b>83940</b>	Kit composto da - Kit consists of: - Meccanismo/Clutch Ref. 3540480M92 With box Original LANDINI - Disco Pto/Disc Pto Ref. 1424135M93 Not Original - Cuscinetto/Bearing Ref. 1423473M94 Not Original - Cuscinetto/Bearing Ref. 1442381X1 Not Original	<b>MASSEY FERGUSON</b>	134C-134V-154-154C-154F-154S, 154S-154V-164TF-164TS-164TV, 174-174C-174F-174S-174V-184, 184F - 184S - 184F - 194S, 233-234C-234CF-244CF-253-254, 234S-283-284-293-294-294C-294S, 254C-254CF-254S-263-263T-264T, 274-274C-274CF-274S-274SK-284S, 333-334V-353-353LX-353S-354AP, 354AQ-354F-354FP-354FQ-354GE, 354S-354SP-354V-354VQ-363-363S, 364FQ-364GE-364S-364SP-364SQ, 364SP-364AQ-364CF-364F-364FP, 364V-373LX-373S-374AP-374AQ, 367CF-376C-376CF-376XCF-377, 374F-374FP-374FQ-374GE-374H, 374S-374SP-374VQ-384S-393TLX, 383-383LX-383S-384AP-384AQ, 384F-384FP-384FQ-384SP-384SQ, 384V-384VQ-393-393LX-393S, 394AP-394AQ-394C-394F-394FQ, 394FP-394TAQ-396-396C-396CF, 394GE-394H-394S-394SP-394SQ, 396CF, 396CT	3540480M91, 3540480M92	
<b>LN3540480M91</b>	Meccanismo Frizione 11" - Landini originale/Clutch 11" - Original Landini		134C-134V-154-154C-154F-154S, 154S-154V-164TF-164TS-164TV, 174-174C-174F-174S-174V-184, 184F - 184S - 184F - 194S, 233-234C-234CF-244CF-253-254, 234S-283-284-293-294-294C-294S, 254C-254CF-254S-263-263T-264T, 274-274C-274CF-274S-274SK-284S, 333-334V-353-353LX-353S-354AP, 354AQ-354F-354FP-354FQ-354GE, 354S-354SP-354V-354VQ-363-363S, 364FQ-364GE-364S-364SP-364SQ, 364SP-364AQ-364CF-364F-364FP, 364V-373LX-373S-374AP-374AQ, 367CF-376C-376CF-376XCF-377, 374F-374FP-374FQ-374GE-374H, 374S-374SP-374VQ-384S-393TLX, 383-383LX-383S-384AP-384AQ, 384F-384FP-384FQ-384SP-384SQ, 384V-384VQ-393-393LX-393S, 394AP-394AQ-394C-394F-394FQ, 394FP-394TAQ-396-396C-396CF, 394GE-394H-394S-394SP-394SQ, 396CF, 396CT	3540480M91, 3540480M92	
<b>70467</b>	Disco Pto Diametro 280 mm / Pto Disc Diameter 280 mm		154-154C-154F-154S-154V, 174-174C-174F-174S-174V, 184-184F-184S, 194-194C-194F-194S, 233-234C-234CF-234S, 253-254-254C-254CF-254S, 263-263T-264T-264TCF-264TS, 274C-274CF-274S-274SK, 283-284-284S-293-294-294C-294S, 333-334V-353-353LX-353S, 354AP-354AQ-354F-354FP, 354FQ-354GE-354S-354SP-354SQ, 354V-354VQ-363, 364AP-364AQ-364CF-364F-364FP, 364FQ-364GE-364S-364SP-364SQ, 364V-364VQ-367CF, 373-373S-374AP-374AQ-374F, 374FP-374FQ-374GE-374H-374S, 374SP-374SQ-374VQ, 376C-376CF-376XCF-377, 383-383LX-383S-384AP-384AQ, 384F-384FP-384FQ-384GE-384S, 384SP-384SQ-384V-384VQ, 393-393LX-393S-393TLX, 394AP-394AQ-394C-394F-394FP, 394AQ-394TAQ-396-396C-396CF, 394FQ-394GE-394H-394S-394SP	1424135M93	
<b>12841</b>	Cuscinetto reggispinta 90 x 50 x 21,60 mm / Thrust Bearing 90 x 50 x 21,60 mm		154,154C,154F,154S,154V,174, 174C/F/S/V,184,184F/S,194,194C, 194F/S,1007,233,234,253,254, 254C/CF/S,263T,264T/TCF/TS, 273,274,274C/CF/S/SK,283,284, 284S,293,294,294C/S,333,333V, 353,353LX/S, 354AP/AQ/F/FP/FQ/GE/S/SP/SQ/V, 363, 364AP/AQ/F/FP/FQ/GE/S/SP/SQ/V, 374AP/AQ/F/FP/FQ/GE/S/SP/SQ/V, 376C/CF/XCF,377,383,383LX/S, 384AP/AQ/F/FP/FQ/GE/S/SP/SQ/V, 393,393LX/S/TLX, 394AP/AQ/F/FP/FQ/GE/S/SP/SQ, 396	1423473M93, 391347X1	
<b>15757</b>	Cuscinetto pto 100 x 65 x 11 mm / Pto Bearing 100 x 65 x 11 mm		1007, 134,154,164,174,184,194, 233,234,244,253,254,263,264, 274,283,284,293,294, 333,334,353,354,363,364,373, 374,376,377,383,384,393,394, 396	1442381X1	

Art./Ref.	Note/Notes	Brand	Applicazione/Application	Rif. Orig./Orig. Ref.	Immagine/Image
<b>85025</b>	Kit composto da - Kit consists of: - Meccanismo/Clutch Ref. 3540480M92 With box Original LUK - Disco Pto/Disc Pto Ref. 1424135M93 Not Original - Cuscinetto/Bearing Ref. 1423473M94 Not Original - Cuscinetto/Bearing Ref. 1442381X1 Not Original	<b>MASSEY FERGUSON</b>	134C-134V-154-154C-154F-154S, 154S-154V-164TF-164TS-164TV, 174-174C-174F-174S-174V-184, 184F - 184S - 184F - 194S, 233-234C-234CF-244CF-253-254, 234S-283-284-293-294-294C-294S, 254C-254CF-254S-263-263T-264T, 274-274C-274CF-274S-274SK-284S, 333-334V-353-353LX-353S-354AP, 354AQ-354F-354FP-354FQ-354GE, 354S-354SP-354V-354VQ-363-363S, 364FQ-364GE-364S-364SP-364SQ, 364SP-364AQ-364CF-364F-364FP, 364V-373LX-373S-374AP-374AQ, 367CF-376C-376CF-376XCF-377, 374F-374FP-374FQ-374GE-374H, 374S-374SP-374VQ-384S-393TLX, 383-383LX-383S-384AP-384AQ, 384F-384FP-384FQ-384SP-384SQ, 384V-384VQ-393-393LX-393S, 394AP-394AQ-394C-394F-394FQ, 394FP-394TAQ-396-396C-396CF, 394GE-394H-394S-394SP-394SQ, 396CF, 396CT	3540480M91, 3540480M92	
<b>07898</b>	Meccanismo Frizione 11" - Luk originale/Clutch 11" - Original Luk		134C,134V,154,154F/S/V, 174C/S/V,184F/S,194C/F/S, 244CF,254C/CF/S,263T,264T/TS, 274C/CF/S,284S,294C/S, MF 367 CF, MF 376 C, MF 376 CF, MF 376 XCF, MF 377, MF 383, MF 383 LX, MF 383 S, MF 384 AQ, MF 384 F, MF 384 FQ, MF 384 SP-FP-AP-GE, MF 384 SQ, MF 384 V, MF 384 VQ, MF 384/3225 SPX-FPX-APX-GEX, MF 393, MF 393 LX, MF 393 S, MF 394 AQ, MF 394 F-H, MF 394 FQ, MF 394 SP-FP-AP-GE, MF 394 SQ, MF 394/3235 SPX-FPX-APX-GEX, MF 396 CF	3304583M95, 3540480M91, 3540480M92, 3600242M91	
<b>70467</b>	Disco Pto Diametro 280 mm / Pto Disc Diameter 280 mm		154-154C-154F-154S-154V, 174-174C-174F-174S-174V, 184-184F-184S, 194-194C-194F-194S, 233-234C-234CF-234S, 253-254-254C-254CF-254S, 263-263T-264T-264TCF-264TS, 274C-274CF-274S-274SK, 283-284-284S-293-294-294C-294S, 333-334V-353-353LX-353S, 354AP-354AQ-354F-354FP, 354FQ-354GE-354S-354SP-354SQ, 354V-354VQ-363, 364AP-364AQ-364CF-364F-364FP, 364FQ-364GE-364S-364SP-364SQ, 364V-364VQ-367CF, 373-373S-374AP-374AQ-374F, 374FP-374FQ-374GE-374H-374S, 374SP-374SQ-374VQ, 376C-376CF-376XCF-377, 383-383LX-383S-384AP-384AQ, 384F-384FP-384FQ-384GE-384S, 384SP-384SQ-384V-384VQ, 393-393LX-393S-393TLX, 394AP-394AQ-394C-394F-394FP, 394AQ-394TAQ-396-396C-396CF, 394FQ-394GE-394H-394S-394SP	1424135M93	
<b>12841</b>	Cuscinetto reggispinta 90 x 50 x 21,60 mm / Thrust Bearing 90 x 50 x 21,60 mm		154,154C,154F,154S,154V,174, 174C/F/S/V,184,184F/S,194,194C,194F/S,1007,233,234,253,254, 254C/CF/S,263T,264T/TCF/TS, 273,274,274C/CF/S/SK,283,284, 284S,293,294,294C/S,333,333V, 353,353LX/S, 354AP/AQ/F/FP/FQ/GE/S/SP/SQ/V, 363, 364AP/AQ/F/FP/FQ/GE/S/SP/SQ/V, 374AP/AQ/F/FP/FQ/GE/S/SP/SQ/V, 376C/CF/XCF,377,383,383LX/S, 384AP/AQ/F/FP/FQ/GE/S/SP/SQ/V, 393,393LX/S/TLX, 394AP/AQ/F/FP/FQ/GE/S/SP/SQ, 396	1423473M93, 391347X1	
<b>15757</b>	Cuscinetto pto 100 x 65 x 11 mm / Pto Bearing 100 x 65 x 11 mm		1007, 134,154,164,174,184,194, 233,234,244,253,254,263,264, 274,283,284,293,294, 333,334,353,354,363,364,373, 374,376,377,383,384,393,394, 396	1442381X1	
<b>LUK628052210</b>	Kit tutto originale LUK composto da - Kit all LUK original consists of: - Meccanismo/Clutch Ref. 228 0003 14 - Disco Pto/Disc Pto 328 0083 16 - Cuscinetto/Bearing Ref. 500 0459 00 - Cuscinetto/Bearing Ref. 500 1107 10 - Cuscinetto/Bearing Ref. 410 0042 10		<b>MASSEY FERGUSON</b>	134C-134V-154-154C-154F-154S, 154S-154V-164TF-164TS-164TV, 174-174C-174F-174S-174V-184, 184F - 184S - 184F - 194S, 233-234C-234CF-244CF-253-254, 234S-283-284-293-294-294C-294S, 254C-254CF-254S-263-263T-264T, 274-274C-274CF-274S-274SK-284S, 333-334V-353-353LX-353S-354AP, 354AQ-354F-354FP-354FQ-354GE, 354S-354SP-354V-354VQ-363-363S, 364FQ-364GE-364S-364SP-364SQ, 364SP-364AQ-364CF-364F-364FP, 364V-373LX-373S-374AP-374AQ, 367CF-376C-376CF-376XCF-377, 374F-374FP-374FQ-374GE-374H, 374S-374SP-374VQ-384S-393TLX, 383-383LX-383S-384AP-384AQ, 384F-384FP-384FQ-384SP-384SQ, 384V-384VQ-393-393LX-393S, 394AP-394AQ-394C-394F-394FQ, 394FP-394TAQ-396-396C-396CF, 394GE-394H-394S-394SP-394SQ, 396CF, 396CT	1423473M94, 1424135M94, 1442381X1, 339599X1, 3540480M91, 3540480M92

<b>LUK628052209</b>	Kit tutto originale LUK composto da - Kit all LUK original consists of: - Meccanismo/Clutch Ref. 228 0003 14 - Disco Pto/Disc Pto 328 0083 16	<b>MASSEY FERGUSON</b>	134C-134V-154-154C-154F-154S, 154S-154V-164TF-164TS-164TV, 174-174C-174F-174S-174V-184, 184F - 184S - 184F - 194S, 233-234C-234CF-244CF-253-254, 234S-283-284-293-294-294C-294S, 254C-254CF-254S-263-263T-264T, 274-274C-274CF-274S-274SK-284S, 333-334V-353-353LX-353S-354AP, 354AQ-354F-354FP-354FQ-354GE, 354S-354SP-354V-354VQ-363-363S, 364FQ-364GE-364S-364SP-364SQ, 364SP-364AQ-364CF-364F-364FP, 364V-373LX-373S-374AP-374AQ, 367CF-376C-376CF-376XCF-377, 374F-374FP-374FQ-374GE-374H, 374S-374SP-374VQ-384S-393TLX, 383-383LX-383S-384AP-384AQ, 384F-384FP-384FQ-384SP-384SQ, 384V-384VQ-393-393LX-393S, 394AP-394AQ-394C-394F-394FQ, 394FP-394TAQ-396-396C-396CF, 394GE-394H-394S-394SP-394SQ, 396CF, 396CT	1424135M94, 3540480M91, 3540480M92	
<b>LUK500045900</b>	Cuscinetto reggispinta 90 x 50 x 21,60 mm / Thrust Bearing 90 x 50 x 21,60 mm		154,154C,154F,154S,154V,174, 174C/F/S/V,184,184F/S,194,194C, 194F/S,1007,233,234,253,254, 254C/CF/S,263T,264T/TCF/TS, 273,274,274C/CF/S/SK,283,284, 284S,293,294,294C/S,333,333V, 353,353LX/S, 354AP/AQ/F/FP/FQ/GE/S/SP/SQ/V, 363, 364AP/AQ/F/FP/FQ/GE/S/SP/SQ/V, 374AP/AQ/F/FP/FQ/GE/S/SP/SQ/V, 376C/CF/XCF,377,383,383LX/S, 384AP/AQ/F/FP/FQ/GE/S/SP/SQ/V, 393,393LX/S/TLX, 394AP/AQ/F/FP/FQ/GE/S/SP/SQ, 396	1423473M93, 391347X1	
<b>LUK500110710</b>	Cuscinetto pto 100 x 65 x 11 mm / Pto Bearing 100 x 65 x 11 mm		134C,134V,154,154F/S/V, 174C/S/V,184F/S,194C/F/S, 244CF,254C/CF/S,263T,264T/TS, 274C/CF/S,284S,294C/S, MF 367 CF, MF 376 C, MF 376 CF, MF 376 XCF, MF 377, MF 383, MF 383 LX, MF 383 S, MF 384 AQ, MF 384 F, MF 384 FQ, MF 384 SP-FP-AP-GE, MF 384 SQ, MF 384 V, MF 384 VQ, MF 384/3225 SPX-FPX-APX-GEX, MF 393, MF 393 LX, MF 393 S, MF 394 AQ, MF 394 F-H, MF 394 FQ, MF 394 SP-FP-AP-GE, MF 394 SQ, MF 394/3235 SPX-FPX-APX-GEX, MF 396 CF	1442381X1	
<b>LUK410004210</b>	Cuscinetto volano 47 x 20 x 14 mm/ Bearing 47 x 20 x 14 mm		134C,134V,154,154F/S/V, 174C/S/V,184F/S,194C/F/S, 244CF,254C/CF/S,263T,264T/TS, 274C/CF/S,284S,294C/S, MF 367 CF, MF 376 C, MF 376 CF, MF 376 XCF, MF 377, MF 383, MF 383 LX, MF 383 S, MF 384 AQ, MF 384 F, MF 384 FQ, MF 384 SP-FP-AP-GE, MF 384 SQ, MF 384 V, MF 384 VQ, MF 384/3225 SPX-FPX-APX-GEX, MF 393, MF 393 LX, MF 393 S, MF 394 AQ, MF 394 F-H, MF 394 FQ, MF 394 SP-FP-AP-GE, MF 394 SQ, MF 394/3235 SPX-FPX-APX-GEX, MF 396 CF	339599X1	

**KIT FRIZIONE ADATTABILE RIF. 631064210 MASSEY FERGUSON**

KIT EMBRAYAGE ADAPTABLE REF. 631064210 MASSEY FERGUSON

KIT CLUTCH ADAPTABLE REF. 631064210 MASSEY FERGUSON

KIT KUPPLUNG PASSEND ZU REF. 631064210 MASSEY FERGUSON

KIT EMBRAGUE ADAPTABLE REF. 631064210 MASSEY FERGUSON

Art./Ref.	Note/Notes	Brand	Applicazione/Application	Rif. Orig./Orig. Ref.	Immagine/Image
<b>83941</b>	Kit composto da - Kit consists of: - Meccanismo/Clutch Ref. 3540478M92 With box Original LANDINI - Disco Pto/Disc Pto Ref. 3105233M92 Not Original - Cuscinetto/Bearing Ref. 1423473M94 Not Original - Cuscinetto/Bearing Ref. 1442381X1 Not Original	<b>MASSEY FERGUSON</b>	1007, 154-154C-154F-154S-154V, 174-174C-174S-174V, 184-184F-184S, 194-194C-194F-194S, 233-234C-234CF-234S, 244CF-253-254-254C-254CF-254S, 263-263T-264T, 274-274C-274CF-274S-274SK, 283-284-284S-293-294-294C-294S, 333-334V-353-353LX-353S, 354AP-354AQ-354F-354FP-354FQ, 354GE-354S-354SP-354V-354VQ, 363-363S-364AP-364AQ-364CF, 364F-364FP-364FQ-364GE-364S, 364SP-364SQ-364V-373LX-373S, 374AP-374AQ-374F-374FP-374FQ, 374GE-374H-374S-374SP-374V, 374VQ-376C-376CF-376XCF-377, 383-383LX-383S-384AP-384AQ, 384F-384FP-384GE-384S-384SP, 384SQ-384V-384VQ-387, 393-393LX-393S-393TLX, 394AP-394FP-394FQ-394GE-394H, 394S-394SP-394SQ-394TAQ, 396-396C-396CF, 397 - 397T	3540478M92, 6521050M91	
<b>LN3540478M92</b>	Meccanismo Frizione 12" - Landini originale/Clutch 12" - Original Landini		1007, 154-154C-154F-154S-154V, 174-174C-174S-174V, 184-184F-184S, 194-194C-194F-194S, 233-234C-234CF-234S, 244CF-253-254-254C-254CF-254S, 263-263T-264T, 274-274C-274CF-274S-274SK, 283-284-284S-293-294-294C-294S, 333-334V-353-353LX-353S, 354AP-354AQ-354F-354FP-354FQ, 354GE-354S-354SP-354V-354VQ, 363-363S-364AP-364AQ-364CF, 364F-364FP-364FQ-364GE-364S, 364SP-364SQ-364V-373LX-373S, 374AP-374AQ-374F-374FP-374FQ, 374GE-374H-374S-374SP-374V, 374VQ-376C-376CF-376XCF-377, 383-383LX-383S-384AP-384AQ, 384F-384FP-384GE-384S-384SP, 384SQ-384V-384VQ-387, 393-393LX-393S-393TLX, 394AP-394FP-394FQ-394GE-394H, 394S-394SP-394SQ-394TAQ, 396-396C-396CF, 397 - 397T	3540478M92, 6521050M91	

Art./Ref.	Note/Notes	Brand	Applicazione/Application	Rif. Orig./Orig. Ref.	Immagine/Image
<b>07905</b>	Disco Pto Diametro 310 mm / Pto Disc Diameter 310 mm	<b>MASSEY FERGUSON</b>	MF 1007, MF 373, MF 373 LX, MF 373 S, MF 374 AQ, MF 374 FQ, MF 374 SP-FP-AP-GE, MF 374 SQ, MF 374 V, MF 374 VQ, MF 374/3220 SPX-FPX-APX-GEX, MF 376 C, MF 377, MF 383, MF 383 LX, MF 383 S, MF 384 AQ, MF 384 FQ, MF 384 SP-FP-AP-GE, MF 384 SQ, MF 384 V, MF 384 VQ, MF 384/3225 SPX-FPX-APX-GEX, MF 387, MF 393, MF 393 LX, MF 393 S, MF 393 TLX, MF 394 AQ, MF 394 FQ, MF 394 SP-FP-AP-GE, MF 394 SQ, MF 394 T, MF 394/3235 SPX-FPX-APX-GEX, MF 396 C, MF 396 CT, MF 397, MF 397 T, MF 3977	3105233M91, 3105233M92, 3311352M92	
<b>12841</b>	Cuscinetto reggispinta 90 x 50 x 21,60 mm / Thrust Bearing 90 x 50 x 21,60 mm		154,154C,154F,154S,154V,174, 174C/F/S/V,184,184F/S,194,194C,194F/S,1007,233,234,253,254, 254C/CF/S,263T,264T/TCF/TS, 273,274,274C/CF/S/SK,283,284, 284S,293,294,294C/S,333,333V, 353,353LX/S, 354AP/AQ/F/FP/FQ/GE/S/SP/SQ/V, 363, 364AP/AQ/F/FP/FQ/GE/S/SP/SQ/V, 374AP/AQ/F/FP/FQ/GE/S/SP/SQ/V, 376C/CF/XCF,377,383,383LX/S, 384AP/AQ/F/FP/FQ/GE/S/SP/SQ/V, 393,393LX/S/TLX, 394AP/AQ/F/FP/FQ/GE/S/SP/SQ, 396	1423473M93, 391347X1	
<b>15757</b>	Cuscinetto pto 100 x 65 x 11 mm / Pto Bearing 100 x 65 x 11 mm		1007, 134,154,164,174,184,194, 233,234,244,253,254,263,264, 274,283,284,293,294, 333,334,353,354,363,364,373, 374,376,377,383,384,393,394, 396	1442381X1	
<b>85028</b>	Kit composto da - Kit consists of: - Meccanismo/Clutch Ref. 3540478M92 With box Original LUK - Disco Pto/Disc Pto Ref. 3105233M92 Not Original - Cuscinetto/Bearing Ref. 1423473M94 Not Original - Cuscinetto/Bearing Ref. 1442381X1 Not Original	<b>MASSEY FERGUSON</b>	1007, 154-154C-154F-154S-154V, 174-174C-174S-174V, 184-184F-184S, 194-194C-194F-194S, 233-234C-234CF-234S, 244CF-253-254-254C-254CF-254S, 263-263T-264T, 274-274C-274CF-274S-274SK, 283-284-284S-293-294-294C-294S, 333-334V-353-353LX-353S, 354AP-354AQ-354F-354FP-354FQ, 354GE-354S-354SP-354V-354VQ, 363-363S-364AP-364AQ-364CF, 364F-364FP-364FQ-364GE-364S, 364SP-364SQ-364V-373LX-373S, 374AP-374AQ-374F-374FP-374FQ, 374GE-374H-374S-374SP-374V, 374VQ-376C-376CF-376XCF-377, 383-383LX-383S-384AP-384AQ, 384F-384FP-384GE-384S-384SP, 384SQ-384V-384VQ-387, 393-393LX-393S-393TLX, 394AP-394FP-394FQ-394GE-394H, 394S-394SP-394SQ-394TAQ, 396-396C-396CF, 397 - 397T	3540478M92, 6521050M91	
<b>07903</b>	Meccanismo Frizione 12" - Luk originale/Clutch 12" - Original Luk		1007, 154-154C-154F-154S-154V, 174-174C-174S-174V, 184-184F-184S, 194-194C-194F-194S, 233-234C-234CF-234S, 244CF-253-254-254C-254CF-254S, 263-263T-264T-264TCF, 273-274-274C-274CF-274S-274SK, 283-284-284S, 293-294-294C-294S, 333-334V-353-353LX-353S, 354AP-354AQ-354F-354FP-354FQ, 354GE-354S-354SP-354SQ-354V, 354VQ-363-363S, 364AP-364AQ-364CF-364F-364FP, 364FQ-364GE-364S-364SP-364SQ, 364V-364VQ-367CF-373-373LX, 373S-374AP-374AQ-374F-374FP, 374FQ-374GE-374H-374S-374SP, 374V-374VQ-376C-376CF-376XCF, 377-383-383LX-383S-384AP, 384AQ-384F-384FP-384FQ-384GE, 384S-384SP-384SQ-384V-384VQ, 387-393-393LX-393S-393TLX, 394AP-394AQ-394C-394F-394FP, 394FQ-394GE-394H-394S-394SP, 394SQ-394TAQ-396-396C-396CF, 396CT-397-397T	3532192M96, 3532193M94, 3540478M91, 3540478M92, 354072M93, 6521050M91	
<b>07905</b>	Disco Pto Diametro 310 mm / Pto Disc Diameter 310 mm		MF 1007, MF 373, MF 373 LX, MF 373 S, MF 374 AQ, MF 374 FQ, MF 374 SP-FP-AP-GE, MF 374 SQ, MF 374 V, MF 374 VQ, MF 374/3220 SPX-FPX-APX-GEX, MF 376 C, MF 377, MF 383, MF 383 LX, MF 383 S, MF 384 AQ, MF 384 FQ, MF 384 SP-FP-AP-GE, MF 384 SQ, MF 384 V, MF 384 VQ, MF 384/3225 SPX-FPX-APX-GEX, MF 387, MF 393, MF 393 LX, MF 393 S, MF 393 TLX, MF 394 AQ, MF 394 FQ, MF 394 SP-FP-AP-GE, MF 394 SQ, MF 394 T, MF 394/3235 SPX-FPX-APX-GEX, MF 396 C, MF 396 CT, MF 397, MF 397 T, MF 3977	3105233M91, 3105233M92, 3311352M92	
<b>12841</b>	Cuscinetto reggispinta 90 x 50 x 21,60 mm / Thrust Bearing 90 x 50 x 21,60 mm		154,154C,154F,154S,154V,174, 174C/F/S/V,184,184F/S,194,194C,194F/S,1007,233,234,253,254, 254C/CF/S,263T,264T/TCF/TS, 273,274,274C/CF/S/SK,283,284, 284S,293,294,294C/S,333,333V, 353,353LX/S, 354AP/AQ/F/FP/FQ/GE/S/SP/SQ/V, 363, 364AP/AQ/F/FP/FQ/GE/S/SP/SQ/V, 374AP/AQ/F/FP/FQ/GE/S/SP/SQ/V, 376C/CF/XCF,377,383,383LX/S, 384AP/AQ/F/FP/FQ/GE/S/SP/SQ/V, 393,393LX/S/TLX, 394AP/AQ/F/FP/FQ/GE/S/SP/SQ, 396	1423473M93, 391347X1	
<b>15757</b>	Cuscinetto pto 100 x 65 x 11 mm / Pto Bearing 100 x 65 x 11 mm		1007, 134,154,164,174,184,194, 233,234,244,253,254,263,264, 274,283,284,293,294, 333,334,353,354,363,364,373, 374,376,377,383,384,393,394, 396	1442381X1	

Art./Ref.	Note/Notes	Brand	Applicazione/Application	Rif. Orig./Orig. Ref.	Immagine/Image
<b>LUK500115910</b>	Cuscinetto reggispinta 94 x 50 x 22 mm / Thrust Bearing 94 x 50 x 22 mm	<b>MASSEY FERGUSON</b>	1007, 154-154C-154F-154S-154V, 174-174C-174S-174V, 184-184F-184S, 194-194C-194F-194S, 233-234C-234CF-234S, 244CF-253-254-254C-254CF-254S, 263-263T-264T, 274-274C-274CF-274S-274SK, 283-284-284S-293-294-294C-294S, 333-334V-353-353LX-353S, 354AP-354AQ-354F-354FP-354FQ, 354GE-354S-354SP-354V-354VQ, 363-363S-364AP-364AQ-364CF, 364F-364FP-364FQ-364GE-364S, 364SP-364SQ-364V-373LX-373S, 374AP-374AQ-374F-374FP-374FQ, 374GE-374H-374S-374SP-374V, 374VQ-376C-376CF-376XCF-377, 383-383LX-383S-384AP-384AQ, 384F-384FP-384GE-384S-384SP, 384SQ-384V-384VQ-387, 393-393LX-393S-393TLX, 394AP-394FP-394FQ-394GE-394H, 394S-394SP-394SQ-394TAQ, 396-396C-396CF, 397 - 397T	1423473M94	
<b>LUK500110710</b>	Cuscinetto pto 100 x 65 x 11 mm / Pto Bearing 100 x 65 x 11 mm		134C, 134V, 154, 154F/S/V, 174C/S/V, 184F/S, 194C/F/S, 244CF, 254C/CF/S, 263T, 264T/TS, 274C/CF/S, 284S, 294C/S, MF 367 CF, MF 376 C, MF 376 CF, MF 376 XCF, MF 377, MF 383, MF 383 LX, MF 383 S, MF 384 AQ, MF 384 F, MF 384 FQ, MF 384 SP-FP-AP-GE, MF 384 SQ, MF 384 V, MF 384 VQ, MF 384/3225 SPX-FPX-APX-GEX, MF 393, MF 393 LX, MF 393 S, MF 394 AQ, MF 394 F-H, MF 394 FQ, MF 394 SP-FP-AP-GE, MF 394 SQ, MF 394/3235 SPX-FPX-APX-GEX, MF 396 CF	1442381X1	
<b>LUK410004210</b>	Cuscinetto volano 47 x 20 x 14 mm/Bearing 47 x 20 x 14 mm		134C, 134V, 154, 154F/S/V, 174C/S/V, 184F/S, 194C/F/S, 244CF, 254C/CF/S, 263T, 264T/TS, 274C/CF/S, 284S, 294C/S, MF 367 CF, MF 376 C, MF 376 CF, MF 376 XCF, MF 377, MF 383, MF 383 LX, MF 383 S, MF 384 AQ, MF 384 F, MF 384 FQ, MF 384 SP-FP-AP-GE, MF 384 SQ, MF 384 V, MF 384 VQ, MF 384/3225 SPX-FPX-APX-GEX, MF 393, MF 393 LX, MF 393 S, MF 394 AQ, MF 394 F-H, MF 394 FQ, MF 394 SP-FP-AP-GE, MF 394 SQ, MF 394/3235 SPX-FPX-APX-GEX, MF 396 CF	339599X1	

**MECCANISMO + DISCO PTO ORIGINALE LUK RIF. 631064216**

MECANISME + DISQUE PTO ORIGINAL LUK 631064216  
 COVER ASSEMBLY + ORIGINAL PTO DISC LUK REF. 631064216  
 GETRIEBE + ZAPFWELLENSCHEIBE LUK 631064216  
 MECANISMO + DISCO PTO ORIGINAL LUK REF. 631064216

Art./Ref.	Note/Notes	Brand	Applicazione/Application	Rif. Orig./Orig. Ref.	Immagine/Image
<b>LUK500115910</b>	Cuscinetto reggispinta 94 x 50 x 22 mm / Thrust Bearing 94 x 50 x 22 mm	<b>MASSEY FERGUSON</b>	1007, 154-154C-154F-154S-154V, 174-174C-174S-174V, 184-184F-184S, 194-194C-194F-194S, 233-234C-234CF-234S, 244CF-253-254-254C-254CF-254S, 263-263T-264T, 274-274C-274CF-274S-274SK, 283-284-284S-293-294-294C-294S, 333-334V-353-353LX-353S, 354AP-354AQ-354F-354FP-354FQ, 354GE-354S-354SP-354V-354VQ, 363-363S-364AP-364AQ-364CF, 364F-364FP-364FQ-364GE-364S, 364SP-364SQ-364V-373LX-373S, 374AP-374AQ-374F-374FP-374FQ, 374GE-374H-374S-374SP-374V, 374VQ-376C-376CF-376XCF-377, 383-383LX-383S-384AP-384AQ, 384F-384FP-384GE-384S-384SP, 384SQ-384V-384VQ-387, 393-393LX-393S-393TLX, 394AP-394FP-394FQ-394GE-394H, 394S-394SP-394SQ-394TAQ, 396-396C-396CF, 397 - 397T	1423473M94	
<b>LUK500110710</b>	Cuscinetto pto 100 x 65 x 11 mm / Pto Bearing 100 x 65 x 11 mm		134C, 134V, 154, 154F/S/V, 174C/S/V, 184F/S, 194C/F/S, 244CF, 254C/CF/S, 263T, 264T/TS, 274C/CF/S, 284S, 294C/S, MF 367 CF, MF 376 C, MF 376 CF, MF 376 XCF, MF 377, MF 383, MF 383 LX, MF 383 S, MF 384 AQ, MF 384 F, MF 384 FQ, MF 384 SP-FP-AP-GE, MF 384 SQ, MF 384 V, MF 384 VQ, MF 384/3225 SPX-FPX-APX-GEX, MF 393, MF 393 LX, MF 393 S, MF 394 AQ, MF 394 F-H, MF 394 FQ, MF 394 SP-FP-AP-GE, MF 394 SQ, MF 394/3235 SPX-FPX-APX-GEX, MF 396 CF	1442381X1	
<b>LUK410004210</b>	Cuscinetto volano 47 x 20 x 14 mm/Bearing 47 x 20 x 14 mm		134C, 134V, 154, 154F/S/V, 174C/S/V, 184F/S, 194C/F/S, 244CF, 254C/CF/S, 263T, 264T/TS, 274C/CF/S, 284S, 294C/S, MF 367 CF, MF 376 C, MF 376 CF, MF 376 XCF, MF 377, MF 383, MF 383 LX, MF 383 S, MF 384 AQ, MF 384 F, MF 384 FQ, MF 384 SP-FP-AP-GE, MF 384 SQ, MF 384 V, MF 384 VQ, MF 384/3225 SPX-FPX-APX-GEX, MF 393, MF 393 LX, MF 393 S, MF 394 AQ, MF 394 F-H, MF 394 FQ, MF 394 SP-FP-AP-GE, MF 394 SQ, MF 394/3235 SPX-FPX-APX-GEX, MF 396 CF	339599X1	









**MECCANISMO + DISCO PTO ORIGINALE LUK RIF. 633052319**

MECANISME + DISQUE PTO ORIGINAL LUK 633052319

COVER ASSEMBLY + ORIGINAL PTO DISC LUK REF. 633052319

GETRIEBE + ZAPFWELLENSCHEIBE LUK 633052319

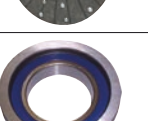
MECANISMO + DISCO PTO ORIGINAL LUK REF. 633052319

Art./Ref.	Note/Notes	Brand	Applicazione/Application	Rif. Orig./Orig. Ref.	Immagine/Image
<b>LUK633052319</b>	Kit tutto originale LUK composto da - Kit all LUK original consists of: - Meccanismo/Clutch Ref. 233 0020 12 - Disco Pto/Disc Pto 333 0019 16	<b>MASSEY FERGUSON</b>	1014 (22904565->),1114,1134, 1024	1426390M94, 3303137M95, 3533765M93, 3540481M91	 
<b>07906</b>	Meccanismo Frizione 13" - Luk originale/Clutch 13" - Original Luk		1007, 1014 (22904565->),1114,1134, 1024	3303137M95, 3533765M93, 3540481M91	
<b>07908</b>	Disco Pto Diametro 330 mm / Pto Disc Diameter 330 mm		1007, 1014, 1114, 1134	1426390M93, 1426390M94	
<b>59850</b>	Cuscinetto reggispinta 92 x 55 x 31 mm / Thrust Bearing 92 x 55 x 31 mm		1014 (->22904564), 1014 (22904565->),1114,1134, 1024	3302143M91	
<b>70427</b>	Cuscinetto pto 115 x 75 x 13 mm / Pto Bearing 115 x 75 x 13 mm		1014 (22904565->),1114,1134, 1024	392191X1	
<b>70433</b>	Cuscinetto volano 52 x 25 x 18 mm/Bearing 52 x 25 x 18 mm		1014 (22904565->),1114,1134, 1024	392168X1	







**KIT FRIZIONE LUK 628302414**

KIT EMBRAYAGE LUK 628302414

KIT CLUTCH LUK 628302414

KIT KUPPLUNG LUK 628302414

KIT EMBRAGUE LUK 628302414

Art./Ref.	Note/Notes	Brand	Applicazione/Application	Rif. Orig./Orig. Ref.	Immagine/Image
<b>LUK628302414</b>	Kit tutto originale LUK composto da - Kit all LUK original consists of: - Meccanismo/Clutch Ref. 228 0209 11 - Disco Pto/Disc Pto 328 0377 11 - Cuscinetto/Bearing Ref. 500 0459 00 - Cuscinetto/Bearing Ref. 500 0058 10 - Cuscinetto/Bearing Ref. 410 0026 00	<b>DEUTZ</b>	AGROCLIMBER 310 VC/L/M/N, AGROCLIMBER V 70 C - V 70 N, AGROCLIMBER V 80 L - V 80 M, AGROCLIMBER V 80 N	0.012.2574.0, 0.012.2574.4, 0.012.2574.4/10, 0.014.9428.3, 0.020.3544.4, 2.2999.209.0, 2.2999.478.0	     

Art./Ref.	Note/Notes	Brand	Applicazione/Application	Rif. Orig./Orig. Ref.	Immagine/Image
85585	Meccanismo Frizione 11" - Luk originale/Clutch 11" - Original Luk	DEUTZ	AGROCLIMBER 310 VC/L/M/N, AGROCLIMBER V 70 C - V 70 N, AGROCLIMBER V 80 L - V 80 M, AGROCLIMBER V 80 N, AGROPLUS 420 F ECOLINE	0.012.2574.4, 0.012.2574.4/10, 0.020.3543.4, 0.020.3544.4	
LUK328037711	Disco Pto Diametro 280 mm Luk originale/Pto Disc Diameter 280 mm Original Luk		AGROCLIMBER 310 VC/L/M/N, AGROCLIMBER V 70 C - V 70 N, AGROCLIMBER V 80 L - V 80 M, AGROCLIMBER V 80 N, AGROPLUS 420 F ECOLINE	0.011.9073.3	
LUK500045900	Cuscinetto reggispinta 90 x 50 x 21,60 mm / Thrust Bearing 90 x 50 x 21,60 mm		AGROCLIMBER 310 VC/L/M/N, AGROCLIMBER V 70 C - V 70 N, AGROCLIMBER V 80 L - V 80 M, AGROCLIMBER V 80 N, AGROPLUS 420 F ECOLINE	2.2999.478.0	
LUK500005810	Cuscinetto pto 140 x 106 x 21 mm / Pto Bearing 140 x 106 x 21 mm		AGROCLIMBER 310 VC/L/M/N, AGROCLIMBER V 70 C - V 70 N, AGROCLIMBER V 80 L - V 80 M, AGROCLIMBER V 80 N	2.2999.209.0	

**MECCANISMO + DISCO AVANZAMENTO ORIGINALE LUK RIF. 628313109**

MECANISME + DISQUE AVANCEMENT ORIGINAL LUK 628313109  
 COVER ASSEMBLY + ORIGINAL MAIN DRIVE LUK REF. 628313109  
 GETRIEBE + VORSCHLEIBE LUK 628313109  
 MECANISMO + DISCO DE AVANCE ORIGINAL LUK REF. 628313109

Art./Ref.	Note/Notes	Brand	Applicazione/Application	Rif. Orig./Orig. Ref.	Immagine/Image
LUK628313109	Kit tutto originale LUK composto da - Kit all LUK original consists of: - Meccanismo/Clutch Ref. 128 0336 10 - Disco Avanzamento/Clutch Disc 328 0275 11	DEUTZ	DEUTZ AGROCOMPACT F60 - F70, DEUTZ AGROLUX 60, DEUTZ AGROLUX F50 - F60, DEUTZ AGROPLUS 60 - 67 - F70	0.015.9286.3, 0.015.9287.3, 0.270.2330.3/10	

**MECCANISMO + DISCO AVANZAMENTO ORIGINALE LUK RIF. 631308219 - 631308209**

MECANISME + DISQUE AVANCEMENT ORIGINAL LUK 631308219 - 631308209  
 COVER ASSEMBLY + ORIGINAL MAIN DRIVE LUK REF. 631308219 - 631308209  
 GETRIEBE + VORSCHLEIBE LUK 631308219 - 631308209  
 MECANISMO + DISCO DE AVANCE ORIGINAL LUK REF. 631308219 - 631308209

Art./Ref.	Note/Notes	Brand	Applicazione/Application	Rif. Orig./Orig. Ref.	Immagine/Image
LUK631308219	Kit tutto originale LUK composto da - Kit all LUK original consists of: - Meccanismo/Clutch Ref. 131 0228 10 - Disco Avanzamento a 6 pale/Clutch Disc 6 pairs of pads 331 0179 11	DEUTZ	DEUTZ AGROCLIMBER F 100 M, DEUTZ AGROCLIMBER F 100 N, DEUTZ AGROCLIMBER F 90 C, DEUTZ AGROCLIMBER F 90 M, DEUTZ AGROCLIMBER F 90 N, DEUTZ AGROCOMPACT F 100 - F 70, DEUTZ AGROCOMPACT F 75 - F 80, DEUTZ AGROCOMPACT F 90, DEUTZ AGROLUX 60 - 70 - 77, DEUTZ AGROLUX 77 LP, DEUTZ AGROLUX F 60 - F 70, DEUTZ AGROLUX F 80, DEUTZ AGROPLUS 67 - 70 - 77, DEUTZ AGROPLUS 80 - 87, DEUTZ AGROPLUS F 100 - F 70, DEUTZ AGROPLUS F 75 - F 90	0.015.9285.3, 0.015.9289.3	
LUK631308209	Kit tutto originale LUK composto da - Kit all LUK original consists of: - Meccanismo/Clutch Ref. 131 0228 10 - Disco Avanzamento/Clutch Disc 331 0179 10		DEUTZ AGROCLIMBER F 100 M, DEUTZ AGROCLIMBER F 100 N, DEUTZ AGROCLIMBER F 90 C, DEUTZ AGROCLIMBER F 90 M, DEUTZ AGROCLIMBER F 90 N, DEUTZ AGROCOMPACT F 100 - F 70, DEUTZ AGROCOMPACT F 75 - F 80, DEUTZ AGROCOMPACT F 90, DEUTZ AGROLUX 60 - 70 - 77, DEUTZ AGROLUX 77 LP, DEUTZ AGROLUX F 60 - F 70, DEUTZ AGROLUX F 80, DEUTZ AGROPLUS 67 - 70 - 77, DEUTZ AGROPLUS 80 - 87, DEUTZ AGROPLUS F 100 - F 70, DEUTZ AGROPLUS F 75 - F 90	0.015.9285.3, 0.015.9288.3	



**MECCANISMO + DISCO AVANZAMENTO ORIGINALE LUK RIF. 633303109**

MECANISME + DISQUE AVANCEMENT ORIGINAL LUK 633303109  
 COVER ASSEMBLY + ORIGINAL MAIN DRIVE LUK REF. 633303109  
 GETRIEBE + VORSCHLEIBE LUK 633303109  
 MECANISMO + DISCO DE AVANCE ORIGINAL LUK 633303109

Art./Ref.	Note/Notes	Brand	Applicazione/Application	Rif. Orig./Orig. Ref.	Immagine/Image
<b>LUK633303109</b>	Kit tutto originale LUK composto da - Kit all LUK original consists of: - Meccanismo/Clutch Ref. 133 0259 10 - Disco Avanzamento a 5 pale/Clutch Disc 5 pairs of pads 333 0186 10	<b>DEUTZ</b>	DEUTZ AGROCLIMBER 105, DEUTZ AGROCLIMBER 410 - 410SIX, DEUTZ AGROFARM 100, DEUTZ AGROFARM 100 ECOLINE, DEUTZ AGROFARM 420 - 420T, DEUTZ AGROFARM 430, DEUTZ AGROLUX 100 - 80, DEUTZ AGROLUX 87 - 87 LP, DEUTZ AGROLUX 90 - 95, DEUTZ AGROLUX 97 - 97 LP, DEUTZ AGROPLUS 95 NEW, DEUTZ AGROTRAC 100 - 110	0.012.7094.3, 0.012.7095.3/10	

**MECCANISMO + DISCO AVANZAMENTO ORIGINALE LUK RIF. 635351009**

MECANISME + DISQUE AVANCEMENT ORIGINAL LUK 635351009  
 COVER ASSEMBLY + ORIGINAL MAIN DRIVE LUK REF. 635351009  
 GETRIEBE + VORSCHLEIBE LUK 635351009  
 MECANISMO + DISCO DE AVANCE ORIGINAL LUK 635351009

Art./Ref.	Note/Notes	Brand	Applicazione/Application	Rif. Orig./Orig. Ref.	Immagine/Image
<b>LUK635351009</b>	Kit tutto originale LUK composto da - Kit all LUK original consists of: - Meccanismo/Clutch Ref. 135 0279 10 - Disco Avanzamento a 7 pale/Clutch Disc 7 pairs of pads 335 0321 10	<b>DEUTZ</b>	DEUTZ AGROSUN 100 - 120 - 140, DEUTZ AGROTRAC 110 - 125, DEUTZ AGROTRAC 130 - 150	0.014.0175.4, 0.014.0176.3	
<b>LUK500059730</b>	Cuscinetto reggispira completo 111 x 65 x 30 mm / Bearing + carrier assy 111 x 65 x 30 mm		AGROSUN 120, AGROSUN 140, AGROTRAC 130, AGROTRAC 150	0.264.6533.3/20	
<b>LUK500084630</b>	Cuscinetto reggispira 90,60 x 55 x 22 mm / Thrust Bearing 90,60 x 55 x 22 mm		AGROTRAC 125, AGROTRAC 130, AGROTRAC 150, AGROTRAC 610, AGROTRAC 620	2.2999.207.0, 2.2999.510.0	

**KIT FRIZIONE LUK 625300710**

KIT EMBRAYAGE LUK 625300710  
 KIT CLUTCH LUK 625300710  
 KIT KUPPLUNG LUK 625300710  
 KIT EMBRAGUE LUK 625300710

Art./Ref.	Note/Notes	Brand	Applicazione/Application	Rif. Orig./Orig. Ref.	Immagine/Image
<b>LUK625300710</b>	Kit tutto originale LUK composto da - Kit all LUK original consists of: - Meccanismo/Clutch Ref. 225 0055 10 - Disco Pto/Disc Pto 323 0556 10 - Cuscinetto/Bearing Ref. 500 0459 00 - Cuscinetto/Bearing Ref. 500 0673 00 - Cuscinetto/Bearing Ref. 410 0026 00	<b>DEUTZ</b>	DEUTZ AGROLUX 57 - F 57	0.008.4743.4, 0.008.4744.3, 0.011.9063.3, 0.012.2564.4, 2.2021.018.0, 2.2999.153.0/10, 2.2999.478.0	

Art./Ref.	Note/Notes	Brand	Applicazione/Application	Rif. Orig./Orig. Ref.	Immagine/Image
<b>LUK500045900</b>	Cuscinetto reggispinta 90 x 50 x 21,60 mm / Thrust Bearing 90 x 50 x 21,60 mm	<b>DEUTZ</b>	AGROCLIMBER 310 VC/L/M/N, AGROCLIMBER V 70 C - V 70 N, AGROCLIMBER V 80 L - V 80 M, AGROCLIMBER V 80 N, AGROPLUS 420 F ECOLINE, DEUTZ AGROLUX 57 - F 57	2.2999.478.0	
<b>LUK500067300</b>	Cuscinetto pto 100 x 65 x 18 mm / Pto Bearing 100 x 65 x 18 mm		DEUTZ AGROLUX 57 - F 57	2.2021.017.0	

**KIT FRIZIONE LUK 631107510**

KIT EMBRAYAGE LUK 631107510

KIT CLUTCH LUK 631107510

KIT KUPPLUNG LUK 631107510

KIT EMBRAGUE LUK 631107510

Art./Ref.	Note/Notes	Brand	Applicazione/Application	Rif. Orig./Orig. Ref.	Immagine/Image
<b>LUK631107510</b>	Kit tutto originale LUK composto da - Kit all LUK original consists of: - Meccanismo/Clutch Ref. 131 0229 10 - Disco avanzamento/Disc clutch 331 0184 10 - Cuscinetto/Bearing Ref. 500 0076 11	<b>DEUTZ</b>	DEUTZ AGROCOMPACT F 60	0.014.9424.3, 0.014.9433.3, 2.2999.475.0	

**MECCANISMO + DISCO AVANZAMENTO ORIGINALE LUK RIF. 635353510 - 635353810**

MECANISME + DISQUE AVANCEMENT ORIGINAL LUK 635353510 - 635353810

COVER ASSEMBLY + ORIGINAL MAIN DRIVE LUK REF. 635353510 - 635353810

GETRIEBE + VORSCHLEIBE LUK 635353510 - 635353810

MECCANISMO + DISCO DE AVANCE ORIGINAL LUK REF. 635353510 - 635353810

Art./Ref.	Note/Notes	Brand	Applicazione/Application	Rif. Orig./Orig. Ref.	Immagine/Image
<b>LUK635353510</b>	Kit tutto originale LUK composto da - Kit all LUK original consists of: - Meccanismo/Clutch Ref. 135 0284 10 - Disco avanzamento 330 mm Z24/Disc clutch 330 mm Z24 333 0215 10 - Cuscinetto/Bearing Ref. 500 0076 11	<b>DEUTZ</b>	DEUTZ AGROLUX 80 - 90, DEUTZ AGROPLUS 75 - 85 - 95	0.015.6381.3, 0.015.6386.3, 2.2999.475.0	
<b>LUK635353810</b>	Kit tutto originale LUK composto da - Kit all LUK original consists of: - Meccanismo/Clutch Ref. 135 0284 10 - Disco avanzamento 350 mm Z24/Disc clutch 350 mm Z24 335 0337 10 - Cuscinetto/Bearing Ref. 500 0076 11		DEUTZ AGROLUX 80 - 90, DEUTZ AGROPLUS 75 - 85 - 95	0.015.6328.3, 0.015.6386.3, 2.2999.475.0	

**KIT FRIZIONE LUK ORIGINALE RIF. MECCANISMO 0.014.9017.3**

KIT EMBRAYAGE LUK ORIGINAL REF. 0.014.9017.3

KIT CLUTCH ORIGINAL LUK REF. 0.014.9017.3

KIT KUPPLUNG LUK REF. 0.014.9017.3

KIT EMBRAGUE LUK ORIGINAL REF. 0.014.9017.3

Art./Ref.	Note/Notes	Brand	Applicazione/Application	Rif. Orig./Orig. Ref.	Immagine/Image
<b>LUK131031210</b>	Meccanismo Frizione 12" - Luk originale/ Clutch 12" - Original Luk	<b>DEUTZ</b>	AGROCLIMBER 400 F - 410 F, AGROCLIMBER F 100 M - F 100 N, AGROCLIMBER F 90 C - F 90 M, AGROCLIMBER F 90 N, AGROFARM 410 - 410 T, AGROFARM 410 T ECOLINE, AGROFARM 410 TB, AGROFARM 420 T ECOLINE, AGROFARM 420 TB, AGROFARM 85 - 85 ECOLINE, AGROLUX 80 - 85, AGROPLUS 100 S, AGROPLUS 315 - 320 - 320 F, AGROPLUS 320 V - 330 V, AGROPLUS 410 - 410 F - 410 V, AGROPLUS 420 F - 420 V, AGROPLUS 430 F - 430 V, AGROPLUS 70 S - 75 S - 90 S, AGROPLUS F 100 - F 70 - F 75, AGROPLUS F 90	0.014.9017.3	
<b>LUK331034610</b>	Disco avanzamento 310 mm a 6 pale Luk originale/Clutch Disc Diameter 310 mm 6 pairs of pads Original Luk		AGROCLIMBER 400 F - 410 F, AGROCLIMBER F 100 M - F 100 N, AGROCLIMBER F 90 C - F 90 M, AGROCLIMBER F 90 N, AGROFARM 410 - 410 T, AGROFARM 410 T ECOLINE, AGROFARM 410 TB, AGROFARM 420 T ECOLINE, AGROFARM 420 TB, AGROFARM 85 - 85 ECOLINE, AGROLUX 80 - 85, AGROPLUS 100 S, AGROPLUS 315 - 320 - 320 F, AGROPLUS 320 V - 330 V, AGROPLUS 410 - 410 F - 410 V, AGROPLUS 420 F - 420 V, AGROPLUS 430 F - 430 V, AGROPLUS 70 S - 75 S - 90 S, AGROPLUS F 100 - F 70 - F 75, AGROPLUS F 90	0.014.9016.3	

**KIT FRIZIONE LUK ORIGINALE RIF. MECCANISMO 0.016.6106.3**

KIT EMBRAYAGE LUK ORIGINAL REF. 0.016.6106.3

KIT CLUTCH ORIGINAL LUK REF. 0.016.6106.3

KIT KUPPLUNG LUK REF. 0.016.6106.3

KIT EMBRAGUE LUK ORIGINAL REF. 0.016.6106.3

Art./Ref.	Note/Notes	Brand	Applicazione/Application	Rif. Orig./Orig. Ref.	Immagine/Image
<b>LUK135028510</b>	Meccanismo Frizione 14" - Luk originale/ Clutch 14" - Original Luk	<b>DEUTZ</b>	DEUTZ AGROLUX 80 - 90	0.016.6106.3	
<b>LUK333011610</b>	Disco avanzamento 330 mm a 6 pale Luk originale/ Clutch Disc Diameter 330 mm 6 pairs of pads Original Luk		DEUTZ AGROLUX 80 - 90	0.016.6105.3	

**KIT FRIZIONE ADATTABILE RIF. 628302415 SDF**

KIT EMBRAYAGE ADAPTABLE REF. 628302415 SDF

KIT CLUTCH ADAPTABLE REF. 628302415 SDF









KIT KUPPLUNG PASSEND ZU REF. 628302415 SDF

KIT EMBRAGUE ADAPTABLE REF. 628302415 SDF

Art./Ref.	Note/Notes	Brand	Applicazione/Application	Rif. Orig./Orig. Ref.	Immagine/Image
<b>85586</b>	Kit composto da - Kit consists of: - Meccanismo/Clutch Ref. 0.012.2574.4 With box Original SDF - Disco Pto/Disc Pto Ref. 0.014.9428.3 Not Original - Cuscinetto/Bearing Ref. 2.2999.478.0 Not Original - Cuscinetto/Bearing Ref. 2.2021.018.0 Not Original	<b>HURLIMANN</b>	H 361 - H 361 XF, H 362 - H 372, H 476 XF - H 481 XF, H 491 XF, H 55 XF - H 70 XF - X 90 XF	0.012.2574.4, 0.012.2574.4/10, 0.014.9428.3, 0.020.3544.4, 2.2021.018.0, 2.2999.478.0	

Art./Ref.	Note/Notes	Brand	Applicazione/Application	Rif. Orig./Orig. Ref.	Immagine/Image
<b>V0.012.2574.4</b>	Meccanismo Frizione 11" - Sdf originale//Clutch 11" - Original Sdf	<b>HURLIMANN</b>	H 100 XF, H 306 XE - H 307 XE, H 361 XF - H 476 XF, H 481 XF - H 491 XF, H 55 XF - H 70 XF, H 75 XF - H 90 XF, XF 100 TRADITION, XF 90 TRADITION	0.012.2574.4, 0.012.2574.4/10, 0.020.3543.4, 0.020.3544.4	
<b>85474</b>	Disco Pto Diametro 280 mm/Pto Disc Diameter 280 mm		H 100 XF, H 306 XE - H 307 XE, H 361 XF - H 476 XF, H 481 XF - H 491 XF, H 55 XF - H 70 XF, H 75 XF - H 90 XF, XF 100 TRADITION, XF 90 TRADITION	0.014.9428.3	
<b>12841</b>	Cuscinetto reggispinta 90 x 50 x 21,60 mm / Thrust Bearing 90 x 50 x 21,60 mm		H 100 XF, H 306 XE - H 307 XE, H 361 XF - H 476 XF, H 481 XF - H 491 XF, H 55 XF - H 70 XF, H 75 XF - H 90 XF, H305XE, H306XE, H307XE, H375, XF 100 TRADITION, XF 90 TRADITION	2.2999.153.0, 2.2999.153.0/10, 2.2999.478.0	
<b>14882</b>	Cuscinetto pto 110 x 70 x 20 mm / Pto Bearing 110 x 70 x 20 mm		H 100 XF, H 306 XE - H 307 XE, H 361 XF - H 476 XF, H 481 XF - H 491 XF, H 55 XF - H 70 XF, H 75 XF - H 90 XF, XF 100 TRADITION, XF 90 TRADITION	2.2021.018.0	

<b>85587</b>	Kit composto da - Kit consists of: - Meccanismo/Clutch Ref. 0.012.2574.4 With box Original LUK - Disco Pto/Disc Pto Ref. 0.014.9428.3 Not Original - Cuscinetto/Bearing Ref. 2.2999.478.0 Not Original - Cuscinetto/Bearing Ref. 2.2021.018.0 Not Original	<b>HURLIMANN</b>	H 361 - H 361 XF, H 362 - H 372, H 476 XF - H 481 XF, H 491 XF, H 55 XF - H 70 XF - X 90 XF	0.012.2574.4, 0.012.2574.4/10, 0.014.9428.3, 0.020.3544.4, 2.2021.018.0, 2.2999.478.0	   
<b>85585</b>	Meccanismo Frizione 11" - Luk originale/Clutch 11" - Original Luk		H 100 XF, H 306 XE - H 307 XE, H 361 XF - H 476 XF, H 481 XF - H 491 XF, H 55 XF - H 70 XF, H 75 XF - H 90 XF, XF 100 TRADITION, XF 90 TRADITION	0.012.2574.4, 0.012.2574.4/10, 0.020.3543.4, 0.020.3544.4	
<b>85474</b>	Disco Pto Diametro 280 mm/Pto Disc Diameter 280 mm		H 100 XF, H 306 XE - H 307 XE, H 361 XF - H 476 XF, H 481 XF - H 491 XF, H 55 XF - H 70 XF, H 75 XF - H 90 XF, XF 100 TRADITION, XF 90 TRADITION	0.014.9428.3	
<b>12841</b>	Cuscinetto reggispinta 90 x 50 x 21,60 mm / Thrust Bearing 90 x 50 x 21,60 mm		H 100 XF, H 306 XE - H 307 XE, H 361 XF - H 476 XF, H 481 XF - H 491 XF, H 55 XF - H 70 XF, H 75 XF - H 90 XF, H305XE, H306XE, H307XE, H375, XF 100 TRADITION, XF 90 TRADITION	2.2999.153.0, 2.2999.153.0/10, 2.2999.478.0	
<b>14882</b>	Cuscinetto pto 110 x 70 x 20 mm / Pto Bearing 110 x 70 x 20 mm		H 100 XF, H 306 XE - H 307 XE, H 361 XF - H 476 XF, H 481 XF - H 491 XF, H 55 XF - H 70 XF, H 75 XF - H 90 XF, XF 100 TRADITION, XF 90 TRADITION	2.2021.018.0	

Art./Ref.	Note/Notes	Brand	Applicazione/Application	Rif. Orig./Orig. Ref.	Immagine/Image
<b>LUK628302415</b>	Kit tutto originale LUK composto da - Kit all LUK original consists of: - Meccanismo/Clutch Ref. 228 0209 11 - Disco Pto/Disc Pto 328 0377 11 - Cuscinetto/Bearing Ref. 500 0459 00 - Cuscinetto/Bearing Ref. 500 0284 00 - Cuscinetto/Bearing Ref. 410 0026 00	<b>HURLIMANN</b>	H 361 - H 361 XF, H 362 - H 372, H 476 XF - H 481 XF, H 491 XF, H 55 XF - H 70 XF - H 90 XF	0.012.2574.4, 0.012.2574.4/10, 0.014.9428.3, 0.020.3544.4, 2.2021.018.0, 2.2999.478.0	    
<b>85585</b>	Meccanismo Frizione 11" - Luk originale/ Clutch 11" - Original Luk		H 100 XF, H 306 XE - H 307 XE, H 361 XF - H 476 XF, H 481 XF - H 491 XF, H 55 XF - H 70 XF, H 75 XF - H 90 XF, XF 100 TRADITION, XF 90 TRADITION	0.012.2574.4, 0.012.2574.4/10, 0.020.3543.4, 0.020.3544.4	
<b>LUK328037711</b>	Disco Pto Diametro 280 mm Luk originale / Pto Disc Diameter 280 mm Original Luk		H 100 XF, H 306 XE - H 307 XE, H 361 XF - H 476 XF, H 481 XF - H 491 XF, H 55 XF - H 70 XF, H 75 XF - H 90 XF, XF 100 TRADITION, XF 90 TRADITION	0.011.9073.3	
<b>LUK500045900</b>	Cuscinetto reggispinta 90 x 50 x 21,60 mm / Thrust Bearing 90 x 50 x 21,60 mm		H 100 XF, H 306 XE - H 307 XE, H 361 XF - H 476 XF, H 481 XF - H 491 XF, H 55 XF - H 70 XF, H 75 XF - H 90 XF, H305XE, H306XE, H307XE, H375, XF 100 TRADITION, XF 90 TRADITION	2.2999.153.0, 2.2999.153.0/10, 2.2999.478.0	
<b>LUK500028400</b>	Cuscinetto pto 110 x 70 x 20 mm / Pto Bearing 110 x 70 x 20 mm		H 100 XF, H 306 XE - H 307 XE, H 361 XF - H 476 XF, H 481 XF - H 491 XF, H 55 XF - H 70 XF, H 75 XF - H 90 XF, XF 100 TRADITION, XF 90 TRADITION	2.2021.018.0	



**MECCANISMO + DISCO AVANZAMENTO ORIGINALE LUK RIF. 628313109**

MECANISME + DISQUE AVANCEMENT ORIGINAL LUK 628313109

COVER ASSEMBLY + ORIGINAL MAIN DRIVE LUK REF. 628313109

GETRIEBE + VORSCHLEIBE LUK 628313109

MECANISMO + DISCO DE AVANCE ORIGINAL LUK REF. 628313109

Art./Ref.	Note/Notes	Brand	Applicazione/Application	Rif. Orig./Orig. Ref.	Immagine/Image
<b>LUK628313109</b>	Kit tutto originale LUK composto da - Kit all LUK original consists of: - Meccanismo/Clutch Ref. 128 0336 10 - Disco Avanzamento/Clutch Disc 328 0275 11	<b>HURLIMANN</b>	HURLIMANN H356, HURLIMANN H358 - H358 PRESTIGE, HURLIMANN H358-4 CLUB, HURLIMANN H466 - H466-4, HURLIMANN H468 - H468 PRESTIGE, HURLIMANN H468-4 CLUB, HURLIMANN H468-4 CLUB BASSO, HURLIMANN XA56, HURLIMANN XA56 TRADITION, HURLIMANN XA606 - XA655, HURLIMANN XA656T, HURLIMANN XA66, HURLIMANN XA66 TRADITION, HURLIMANN XF55 - XF70, HURLIMANN XN706 - XN707, HURLIMANN XS70	0.015.9286.3, 0.015.9287.3, 0.270.2330.3/10	 

**MECCANISMO + DISCO AVANZAMENTO ORIGINALE LUK RIF. 631308219 - 631308209**

MECANISME + DISQUE AVANCEMENT ORIGINAL LUK 631308219 - 631308209  
 COVER ASSEMBLY + ORIGINAL MAIN DRIVE LUK REF. 631308219 - 631308209  
 GETRIEBE + VORSCHLEIBE LUK 631308219 - 631308209  
 MECANISMO + DISCO DE AVANCE ORIGINAL LUK REF. 631308219 - 631308209

Art./Ref.	Note/Notes	Brand	Applicazione/Application	Rif. Orig./Orig. Ref.	Immagine/Image
<b>LUK631308219</b>	Kit tutto originale LUK composto da - Kit all LUK original consists of: - Meccanismo/Clutch Ref. 131 0228 10 - Disco Avanzamento a 6 pale/Clutch Disc 6 pairs of pads 331 0179 11	<b>HURLIMANN</b>	HURLIMANN H468 PRESTIGE, HURLIMANN H468-4 CLUB, HURLIMANN H468-4 CLUB BASSO, HURLIMANN H476 - H478, HURLIMANN H478 PRESTIGE, HURLIMANN H486T - H488T, HURLIMANN PRESTIGE 75TRADITION, HURLIMANN XA607 - XA655, HURLIMANN XA656T - XA657, HURLIMANN XA658 - XA76, HURLIMANN XA76 TRADITION, HURLIMANN XA86, HURLIMANN XA86 TRADITION, HURLIMANN XB75T - XB75TB, HURLIMANN XF100 - XF55 - XF70, HURLIMANN XF75 - XF90, HURLIMANN XN708 - XN709, HURLIMANN XS100 - XS70 - XS75, HURLIMANN XS90	0.015.9285.3, 0.015.9289.3	
<b>LUK631308209</b>	Kit tutto originale LUK composto da - Kit all LUK original consists of: - Meccanismo/Clutch Ref. 131 0228 10 - Disco Avanzamento/Clutch Disc 331 0179 10		HURLIMANN H468 PRESTIGE, HURLIMANN H468-4 CLUB, HURLIMANN H468-4 CLUB BASSO, HURLIMANN H476 - H478, HURLIMANN H478 PRESTIGE, HURLIMANN H486T - H488T, HURLIMANN PRESTIGE 75TRADITION, HURLIMANN XA607 - XA655, HURLIMANN XA656T - XA657, HURLIMANN XA658 - XA76, HURLIMANN XA76 TRADITION, HURLIMANN XA86, HURLIMANN XA86 TRADITION, HURLIMANN XB75T - XB75TB, HURLIMANN XF100 - XF55 - XF70, HURLIMANN XF75 - XF90, HURLIMANN XN708 - XN709, HURLIMANN XS100 - XS70 - XS75, HURLIMANN XS90	0.015.9285.3, 0.015.9288.3	

**MECCANISMO + DISCO AVANZAMENTO ORIGINALE LUK RIF. 633303109**

MECANISME + DISQUE AVANCEMENT ORIGINAL LUK 633303109  
 COVER ASSEMBLY + ORIGINAL MAIN DRIVE LUK REF. 633303109  
 GETRIEBE + VORSCHLEIBE LUK 633303109  
 MECANISMO + DISCO DE AVANCE ORIGINAL LUK 633303109

Art./Ref.	Note/Notes	Brand	Applicazione/Application	Rif. Orig./Orig. Ref.	Immagine/Image
<b>LUK633303109</b>	Kit tutto originale LUK composto da - Kit all LUK original consists of: - Meccanismo/Clutch Ref. 133 0259 10 - Disco Avanzamento a 5 pale/Clutch Disc 5 pairs of pads 333 0186 10	<b>HURLIMANN</b>	HURLIMANN XB 100 T - XB 100 TB, HURLIMANN XB 105 - 105 T, HURLIMANN XB 85 - XB 95, HURLIMANN XB MAX 100, HURLIMANN XB MAX 100 TRADITION, HURLIMANN XB MAX 110, HURLIMANN XT 105 - XT 110, HURLIMANN XT 85 - XT 95	0.012.7094.3, 0.012.7095.3/10	

**MECCANISMO + DISCO AVANZAMENTO ORIGINALE LUK RIF. 635304509**

MECANISME + DISQUE AVANCEMENT ORIGINAL LUK 635304509  
 COVER ASSEMBLY + ORIGINAL MAIN DRIVE LUK REF. 635304509  
 GETRIEBE + VORSCHLEIBE LUK 635304509  
 MECANISMO + DISCO DE AVANCE ORIGINAL LUK 635304509

Art./Ref.	Note/Notes	Brand	Applicazione/Application	Rif. Orig./Orig. Ref.	Immagine/Image
<b>LUK635304509</b>	Kit tutto originale LUK composto da - Kit all LUK original consists of: - Meccanismo/Clutch Ref. 135 0241 10 - Disco Avanzamento a 6 pale/Clutch Disc 6 pairs of pads 335 0186 10	<b>HURLIMANN</b>	HURLIMANN ELITE 6135 XB, HURLIMANN XT 115 - XT 130, HURLIMANN XT 913	0.008.5595.3, 0.008.5596.3	
<b>LUK500084630</b>	Cuscinetto reggispinta 90,60 x 55 x 22 mm / Thrust Bearing 90,60 x 55 x 22 mm		HURLIMANN ELITE 6115 XB, HURLIMANN ELITE 6135 XB, HURLIMANN H478 PRESTIGE, HURLIMANN H478-4, HURLIMANN H488 T PRESTIGE, HURLIMANN H6115 ELITE, HURLIMANN H6135 ELITE, HURLIMANN XT 115 - XT 130, HURLIMANN XT 908, HURLIMANN XT 909, HURLIMANN XT 910.4, HURLIMANN XT 910.6, HURLIMANN XT 913	2.2999.207.0, 2.2999.510.0	





**MECCANISMO + DISCO AVANZAMENTO ORIGINALE LUK RIF. 635351009**

MECANISME + DISQUE AVANCEMENT ORIGINAL LUK 635351009

COVER ASSEMBLY + ORIGINAL MAIN DRIVE LUK REF. 635351009

GETRIEBE + VORSCHLEIBE LUK 635351009

MECANISMO + DISCO DE AVANCE ORIGINAL LUK 635351009

Art./Ref.	Note/Notes	Brand	Applicazione/Application	Rif. Orig./Orig. Ref.	Immagine/Image
<b>LUK635351009</b>	Kit tutto originale LUK composto da - Kit all LUK original consists of: - Meccanismo/Clutch Ref. 135 0279 10 - Disco Avanzamento a 7 pale/Clutch Disc 7 pairs of pads 335 0321 10	<b>HURLIMANN</b>	HURLIMANN H490 - H496T - H5110, HURLIMANN H5116T - H5160, HURLIMANN H6136 - H6160, HURLIMANN H6170T	0.014.0175.4, 0.014.0176.3	
<b>LUK500059730</b>	Cuscinetto reggispinta completo 111 x 65 x 30 mm / Bearing + carrier assy 111 x 65 x 30 mm		H 6136, H 6170 T	0.250.6533.3, 0.264.6533.3/20	
<b>LUK500084630</b>	Cuscinetto reggispinta 90,60 x 55 x 22 mm / Thrust Bearing 90,60 x 55 x 22 mm		HURLIMANN ELITE 6115 XB, HURLIMANN ELITE 6135 XB, HURLIMANN H478 PRESTIGE, HURLIMANN H478-4, HURLIMANN H488 T PRESTIGE, HURLIMANN H6115 ELITE, HURLIMANN H6135 ELITE, HURLIMANN XT 115 - XT 130, HURLIMANN XT 908, HURLIMANN XT 909, HURLIMANN XT 910.4, HURLIMANN XT 910.6, HURLIMANN XT 913	2.2999.207.0, 2.2999.510.0	



**KIT FRIZIONE LUK 625300710**

KIT EMBRAYAGE LUK 625300710

KIT CLUTCH LUK 625300710

KIT KUPPLUNG LUK 625300710

KIT EMBRAGUE LUK 625300710

Art./Ref.	Note/Notes	Brand	Applicazione/Application	Rif. Orig./Orig. Ref.	Immagine/Image
<b>LUK625300710</b>	Kit tutto originale LUK composto da - Kit all LUK original consists of: - Meccanismo/Clutch Ref. 225 0055 10 - Disco Pto/Disc Pto 323 0556 10 - Cuscinetto/Bearing Ref. 500 0459 00 - Cuscinetto/Bearing Ref. 500 0673 00 - Cuscinetto/Bearing Ref. 410 0026 00	<b>HURLIMANN</b>	HURLIMANN H351, HURLIMANN XE 55 TRADITION, HURLIMANN XE F 55 TRADITION	0.008.4743.4, 0.008.4744.3, 0.011.9063.3, 0.012.2564.4, 2.2021.018.0, 2.2999.153.0/10, 2.2999.478.0	
<b>LUK500045900</b>	Cuscinetto reggispinta 90 x 50 x 21,60 mm / Thrust Bearing 90 x 50 x 21,60 mm		H 100 XF, H 306 XE - H 307 XE, H 361 XF - H 476 XF, H 481 XF - H 491 XF, H 55 XF - H 70 XF, H 75 XF - H 90 XF, H305XE, H306XE, H307XE, H375, HURLIMANN H351, HURLIMANN XE 55 TRADITION, HURLIMANN XE F 55 TRADITION, XF 100 TRADITION, XF 90 TRADITION	2.2999.153.0, 2.2999.153.0/10, 2.2999.478.0	
<b>LUK500067300</b>	Cuscinetto pto 100 x 65 x 18 mm / Pto Bearing 100 x 65 x 18 mm		HURLIMANN H351, HURLIMANN XE 55 TRADITION, HURLIMANN XE F 55 TRADITION	2.2021.017.0	

**KIT FRIZIONE LUK 631107510**

KIT EMBRAYAGE LUK 631107510  
 KIT CLUTCH LUK 631107510  
 KIT KUPPLUNG LUK 631107510  
 KIT EMBRAGUE LUK 631107510

Art./Ref.	Note/Notes	Brand	Applicazione/Application	Rif. Orig./Orig. Ref.	Immagine/Image
<b>LUK631107510</b>	Kit tutto originale LUK composto da - Kit all LUK original consists of: - Meccanismo/Clutch Ref. 131 0229 10 - Disco avanzamento/Disc clutch 331 0184 10 - Cuscinetto/Bearing Ref. 500 0076 11	<b>HURLIMANN</b>	HURLIMANN H 4105 ELITE, HURLIMANN H 468 PRESTIGE, HURLIMANN H 468-4 CLUB, HURLIMANN H 488 T PRESTIGE, HURLIMANN XA 606 - XA 607, HURLIMANN XN 706 - XN 707, HURLIMANN XN 708 - XN 709	0.014.9424.3, 0.014.9433.3, 2.2999.475.0	

**MECCANISMO + DISCO AVANZAMENTO ORIGINALE LUK RIF. 633312310 - 633312300**

MECANISME + DISQUE AVANCEMENT ORIGINAL LUK 633312310 - 633312300  
 COVER ASSEMBLY + ORIGINAL MAIN DRIVE LUK REF. 633312310 - 633312300  
 GETRIEBE + VORSCHLEIBE LUK 633312310 - 633312300  
 MECANISMO + DISCO DE AVANCE ORIGINAL LUK REF. 633312310 - 633312300

Art./Ref.	Note/Notes	Brand	Applicazione/Application	Rif. Orig./Orig. Ref.	Immagine/Image
<b>LUK633312310</b>	Kit tutto originale LUK composto da - Kit all LUK original consists of: - Meccanismo/Clutch Ref. 133 0279 10 - Disco avanzamento a 6 pale/Disc clutch 6 pairs of pads 333 0116 10 - Cuscinetto/Bearing Ref. 500 0846 30	<b>HURLIMANN</b>	HURLIMANN H 478 PRESTIGE, HURLIMANN H 478-4, HURLIMANN H 488 T PRESTIGE, HURLIMANN XT 908 - XT 909, HURLIMANN XT 910.4 - XT 910.6	0.008.4184.3, 0.014.9423.3/10, 0.016.6105.3, 2.2999.207.0, 2.2999.510.0	
<b>LUK633312300</b>	Kit tutto originale LUK composto da - Kit all LUK original consists of: - Meccanismo/Clutch Ref. 133 0279 10 - Disco avanzamento/Disc clutch 333 0117 10 - Cuscinetto/Bearing Ref. 500 0846 30		HURLIMANN H 478 PRESTIGE, HURLIMANN H 478-4, HURLIMANN H 488 T PRESTIGE, HURLIMANN XT 908 - XT 909, HURLIMANN XT 910.4 - XT 910.6	0.008.4184.3, 0.014.9423.3/10, 0.014.9431.3, 2.2999.207.0, 2.2999.510.0	
<b>LUK500084630</b>	Cuscinetto reggispinta 90,60 x 55 x 22 mm / Thrust Bearing 90,60 x 55 x 22 mm		HURLIMANN ELITE 6115 XB, HURLIMANN ELITE 6135 XB, HURLIMANN H478 PRESTIGE, HURLIMANN H478-4, HURLIMANN H488 T PRESTIGE, HURLIMANN H6115 ELITE, HURLIMANN H6135 ELITE, HURLIMANN XT 115 - XT 130, HURLIMANN XT 908, HURLIMANN XT 909, HURLIMANN XT 910.4, HURLIMANN XT 910.6, HURLIMANN XT 913	2.2999.207.0, 2.2999.510.0	

**MECCANISMO + DISCO AVANZAMENTO ORIGINALE LUK RIF. 63353510 - 635353810**

MECANISME + DISQUE AVANCEMENT ORIGINAL LUK 635353510 - 635353810

COVER ASSEMBLY + ORIGINAL MAIN DRIVE LUK REF. 635353510 - 635353810

GETRIEBE + VORSCHLEIBE LUK 635353510 - 635353810

MECANISMO + DISCO DE AVANCE ORIGINAL LUK REF. 635353510 - 635353810

Art./Ref.	Note/Notes	Brand	Applicazione/Application	Rif. Orig./Orig. Ref.	Immagine/Image
<b>LUK635353510</b>	Kit tutto originale LUK composto da - Kit all LUK original consists of: - Meccanismo/Clutch Ref. 135 0284 10 - Disco avanzamento 330 mm Z24/Disc clutch 330 mm Z24 333 0215 10 - Cuscinetto/Bearing Ref. 500 0076 11	<b>HURLIMANN</b>	HURLIMANN H 478 PRESTIGE, HURLIMANN H 478-4, HURLIMANN H 488 T PRESTIGE, HURLIMANN XT 908 - XT 909, HURLIMANN XT 910.4 - XT 910.6	0.015.6381.3, 0.015.6386.3, 2.2999.475.0	
<b>LUK635353810</b>	Kit tutto originale LUK composto da - Kit all LUK original consists of: - Meccanismo/Clutch Ref. 135 0284 10 - Disco avanzamento 350 mm Z24/Disc clutch 350 mm Z24 335 0337 10 - Cuscinetto/Bearing Ref. 500 0076 11		HURLIMANN H 478 PRESTIGE, HURLIMANN H 478-4, HURLIMANN H 488 T PRESTIGE, HURLIMANN XT 908 - XT 909, HURLIMANN XT 910.4 - XT 910.6	0.015.6328.3, 0.015.6386.3, 2.2999.475.0	

**MECCANISMO + DISCO AVANZAMENTO ORIGINALE LUK RIF. 635353910**

MECANISME + DISQUE AVANCEMENT ORIGINAL LUK 635353910

COVER ASSEMBLY + ORIGINAL MAIN DRIVE LUK REF. 635353910

GETRIEBE + VORSCHLEIBE LUK 635353910

MECANISMO + DISCO DE AVANCE ORIGINAL LUK REF. 635353910

Art./Ref.	Note/Notes	Brand	Applicazione/Application	Rif. Orig./Orig. Ref.	Immagine/Image
<b>LUK635353910</b>	Kit tutto originale LUK composto da - Kit all LUK original consists of: - Meccanismo/Clutch Ref. 135 0284 10 - Disco avanzamento 350 mm Z21/Disc clutch 350 mm Z21 335 0338 10 - Cuscinetto/Bearing Ref. 500 0076 11	<b>HURLIMANN</b>	HURLIMANN ELITE 6115 XB, HURLIMANN XT 911	0.007.7930.3/10, 0.015.6386.3, 2.2999.475.0	

**KIT FRIZIONE LUK ORIGINALE RIF. MECCANISMO 0.014.9017.3**

KIT EMBRAYAGE LUK ORIGINAL REF. 0.014.9017.3

KIT CLUTCH ORIGINAL LUK REF. 0.014.9017.3

KIT KUPPLUNG LUK REF. 0.014.9017.3

KIT EMBRAGUE LUK ORIGINAL REF. 0.014.9017.3

Art./Ref.	Note/Notes	Brand	Applicazione/Application	Rif. Orig./Orig. Ref.	Immagine/Image
<b>LUK131031210</b>	Meccanismo Frizione 12" - Luk originale/Clutch 12" - Original Luk	<b>HURLIMANN</b>	HURLIMANN XA 70 - XA 80, HURLIMANN XA 90, HURLIMANN XB 85 T - XB 85 TB, HURLIMANN XB 90 - XB 90 T, HURLIMANN XB MAX 85, HURLIMANN XB MAX 85 TRADITION, HURLIMANN XF 100 - XF 110, HURLIMANN XF 70 - XF 75, HURLIMANN XF 80 - XF 90, HURLIMANN XS 100 - XS 110, HURLIMANN XS 80 - XS 90, HURLIMANN XS 90.3, HURLIMANN XV 100 - XV 110, HURLIMANN XV 80 - XV 90, HURLIMANN XV 90.3	0.014.9017.3	
<b>LUK331034610</b>	Disco avanzamento 310 mm a 6 pale Luk originale/Clutch Disc Diameter 310 mm 6 pairs of pads Original Luk		HURLIMANN XA 70 - XA 80, HURLIMANN XA 90, HURLIMANN XB 85 T - XB 85 TB, HURLIMANN XB 90 - XB 90 T, HURLIMANN XB MAX 85, HURLIMANN XB MAX 85 TRADITION, HURLIMANN XF 100 - XF 110, HURLIMANN XF 70 - XF 75, HURLIMANN XF 80 - XF 90, HURLIMANN XS 100 - XS 110, HURLIMANN XS 80 - XS 90, HURLIMANN XS 90.3, HURLIMANN XV 100 - XV 110, HURLIMANN XV 80 - XV 90, HURLIMANN XV 90.3	0.014.9016.3	

**KIT FRIZIONE LUK ORIGINALE RIF. MECCANISMO 0.016.6106.3**

KIT EMBRAYAGE LUK ORIGINAL REF. 0.016.6106.3

KIT CLUTCH ORIGINAL LUK REF. 0.016.6106.3

KIT KUPPLUNG LUK REF. 0.016.6106.3

KIT EMBRAGUE LUK ORIGINAL REF. 0.016.6106.3

Art./Ref.	Note/Notes	Brand	Applicazione/Application	Rif. Orig./Orig. Ref.	Immagine/Image
<b>LUK135028510</b>	Meccanismo Frizione 14" - Luk originale/ Clutch 14" - Original Luk	<b>HURLIMANN</b>	HURLIMANN ELITE 6115 XB, HURLIMANN PRESTIGE 95TRADITION, HURLIMANN XB 85 - XB 85 T, HURLIMANN XB 85 TB, HURLIMANN XB 95 - XB 95 T, HURLIMANN XB 95 TB, HURLIMANN XT 105 - XT 110, HURLIMANN XT 85, HURLIMANN XT 908 - XT 909, HURLIMANN XT 910.4 - XT 910.6, HURLIMANN XT 911, HURLIMANN XT 95	0.016.6106.3	
<b>LUK333011610</b>	Disco avanzamento 330 mm a 6 pale Luk originale/ Clutch Disc Diameter 330 mm 6 pairs of pads Original Luk		HURLIMANN ELITE 6115 XB, HURLIMANN PRESTIGE 95TRADITION, HURLIMANN XB 85 - XB 85 T, HURLIMANN XB 85 TB, HURLIMANN XB 95 - XB 95 T, HURLIMANN XB 95 TB, HURLIMANN XT 105 - XT 110, HURLIMANN XT 85, HURLIMANN XT 908 - XT 909, HURLIMANN XT 910.4 - XT 910.6, HURLIMANN XT 911, HURLIMANN XT 95	0.016.6105.3	

**KIT FRIZIONE ADATTABILE RIF. 628302415 SDF**









KIT EMBRAYAGE ADAPTABLE REF. 628302415 SDF

KIT CLUTCH ADAPTABLE REF. 628302415 SDF

KIT KUPPLUNG PASSEND ZU REF. 628302415 SDF

KIT EMBRAGUE ADAPTABLE REF. 628302415 SDF

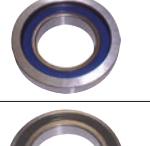
Art./Ref.	Note/Notes	Brand	Applicazione/Application	Rif. Orig./Orig. Ref.	Immagine/Image
<b>85586</b>	Kit composto da - Kit consists of: - Meccanismo/Clutch Ref. 0.012.2574.4 With box Original SDF - Disco Pto/Disc Pto Ref. 0.014.9428.3 Not Original - Cuscinetto/Bearing Ref. 2.2999.478.0 Not Original - Cuscinetto/Bearing Ref. 2.2021.018.0 Not Original	<b>LAMBORGHINI</b>	600 - 660 F PLUS, 700 - 775 F PLUS, 880 F PLUS - 990 F PLUS, PLUS 100 F - 55 F - 70 F, PLUS 75 F - 90 F	0.012.2574.4, 0.012.2574.4/10, 0.014.9428.3, 0.020.3544.4, 2.2021.018.0, 2.2999.478.0	   
<b>VO.012.2574.4</b>	Meccanismo Frizione 11" - Sdf originale/ Clutch 11" - Original Sdf		880 F PLUS - 990 F PLUS, CRONO 564-60, CRONO 574-70, CV 70 C - CV 70 N, CV 80 L - CV 80 M - CV 80 M, GRIMPER 555 L - N - ST, GRIMPER 560 L - N - ST - SST, GRIMPER 570 L - N - ST, PLUS 100 F, PLUS 55 F - 70 F, PLUS 75 F - 90 F	0.012.2574.4, 0.012.2574.4/10, 0.020.3543.4, 0.020.3544.4	
<b>85474</b>	Disco Pto Diametro 280 mm/Pto Disc Diameter 280 mm		880 F PLUS - 990 F PLUS, CRONO 564-60, CRONO 574-70, CV 70 C - CV 70 N, CV 80 L - CV 80 M - CV 80 M, GRIMPER 555 L - N - ST, GRIMPER 560 L - N - ST - SST, GRIMPER 570 L - N - ST, PLUS 100 F, PLUS 55 F - 70 F, PLUS 75 F - 90 F	0.014.9428.3	
<b>12841</b>	Cuscinetto reggispira 90 x 50 x 21,60 mm / Thrust Bearing 90 x 50 x 21,60 mm		880 F PLUS - 990 F PLUS, CRONO 554-50, CRONO 564-60, CRONO 574-70, CRONO 574-75, CV 70 C - CV 70 N, CV 80 L - CV 80 M - CV 80 M, GRIMPER 555/560/570, PLUS 100 F, PLUS 55 F - 70 F, PLUS 75 F - 90 F	2.2999.153.0, 2.2999.153.0/10, 2.2999.478.0	
<b>14882</b>	Cuscinetto pto 110 x 70 x 20 mm / Pto Bearing 110 x 70 x 20 mm		880 F PLUS - 990 F PLUS, CRONO 564-60, CRONO 574-70, CV 70 C - CV 70 N, CV 80 L - CV 80 M - CV 80 M, GRIMPER 555 L - N - ST, GRIMPER 560 L - N - ST - SST, GRIMPER 570 L - N - ST, PLUS 100 F, PLUS 55 F - 70 F, PLUS 75 F - 90 F		

Art./Ref.	Note/Notes	Brand	Applicazione/Application	Rif. Orig./Orig. Ref.	Immagine/Image
<b>85587</b>	Kit composto da - Kit consists of: - Meccanismo/Clutch Ref. 0.012.2574.4 With box Original LUK - Disco Pto/Disc Pto Ref. 0.014.9428.3 Not Original - Cuscinetto/Bearing Ref. 2.2999.478.0 Not Original - Cuscinetto/Bearing Ref. 2.2021.018.0 Not Original	<b>LAMBORGHINI</b>	600 - 660 F PLUS, 700 - 775 F PLUS, 880 F PLUS - 990 F PLUS, PLUS 100 F - 55 F - 70 F, PLUS 75 F - 90 F	0.012.2574.4, 0.012.2574.4/10, 0.014.9428.3, 0.020.3544.4, 2.2021.018.0, 2.2999.478.0	   
<b>85585</b>	Meccanismo Frizione 11" - Luk originale/ Clutch 11" - Original Luk		880 F PLUS - 990 F PLUS, CRONO 564-60, CRONO 574-70, CV 70 C - CV 70 N, CV 80 L - CV 80 M - CV 80 M, GRIMPER 555 L - N - ST, GRIMPER 560 L - N - ST - SST, GRIMPER 570 L - N - ST, PLUS 100 F, PLUS 55 F - 70 F, PLUS 75 F - 90 F	0.012.2574.4, 0.012.2574.4/10, 0.020.3544.4, 0.020.3544.4	
<b>85474</b>	Disco Pto Diametro 280 mm/Pto Disc Diameter 280 mm		880 F PLUS - 990 F PLUS, CRONO 564-60, CRONO 574-70, CV 70 C - CV 70 N, CV 80 L - CV 80 M - CV 80 M, GRIMPER 555 L - N - ST, GRIMPER 560 L - N - ST - SST, GRIMPER 570 L - N - ST, PLUS 100 F, PLUS 55 F - 70 F, PLUS 75 F - 90 F	0.014.9428.3	
<b>12841</b>	Cuscinetto reggispinta 90 x 50 x 21,60 mm / Thrust Bearing 90 x 50 x 21,60 mm		880 F PLUS - 990 F PLUS, CRONO 554-50, CRONO 564-60, CRONO 574-70, CRONO 574-75, CV 70 C - CV 70 N, CV 80 L - CV 80 M - CV 80 M, GRIMPER 555/560/570, PLUS 100 F, PLUS 55 F - 70 F, PLUS 75 F - 90 F	2.2999.153.0, 2.2999.153.0/10, 2.2999.478.0	
<b>14882</b>	Cuscinetto pto 110 x 70 x 20 mm / Pto Bearing 110 x 70 x 20 mm		880 F PLUS - 990 F PLUS, CRONO 564-60, CRONO 574-70, CV 70 C - CV 70 N, CV 80 L - CV 80 M - CV 80 M, GRIMPER 555 L - N - ST, GRIMPER 560 L - N - ST - SST, GRIMPER 570 L - N - ST, PLUS 100 F, PLUS 55 F - 70 F, PLUS 75 F - 90 F	2.2021.018.0	





**KIT FRIZIONE LUK 628302414**





KIT EMBRAYAGE LUK 628302414

KIT CLUTCH LUK 628302414

KIT KUPPLUNG LUK 628302414

KIT EMBRAGUE LUK 628302414

Art./Ref.	Note/Notes	Brand	Applicazione/Application	Rif. Orig./Orig. Ref.	Immagine/Image
<b>LUK628302414</b>	Kit tutto originale LUK composto da - Kit all LUK original consists of: - Meccanismo/Clutch Ref. 228 0209 11 - Disco Pto/Disc Pto 328 0377 11 - Cuscinetto/Bearing Ref. 500 0459 00 - Cuscinetto/Bearing Ref. 500 0058 10 - Cuscinetto/Bearing Ref. 410 0026 00	<b>LAMBORGHINI</b>	CV 70C - CV 70N, CV 80L - CV 80M, CV 80N, GRIMPER 555 L - N - ST, GRIMPER 560 L - N - SST - ST, GRIMPER 570 L - N - ST	0.012.2574.0, 0.012.2574.4, 0.012.2574.4/10, 0.014.9428.3, 0.020.3544.4, 2.2999.209.0, 2.2999.478.0	   

Art./Ref.	Note/Notes	Brand	Applicazione/Application	Rif. Orig./Orig. Ref.	Immagine/Image
85585	Meccanismo Frizione 11" - Luk originale/ Clutch 11" - Original Luk	LAMBORGHINI	880 F PLUS - 990 F PLUS, CRONO 564-60, CRONO 574-70, CV 70 C - CV 70 N, CV 80 L - CV 80 M - CV 80 M, GRIMPER 555 L - N - ST, GRIMPER 560 L - N - ST - SST, GRIMPER 570 L - N - ST, PLUS 100 F, PLUS 55 F - 70 F, PLUS 75 F - 90 F	0.012.2574.4, 0.012.2574.4/10, 0.020.3543.4, 0.020.3544.4	
LUK328037711	Disco Pto Diametro 280 mm Luk originale/Pto Disc Diameter 280 mm Original Luk		880 F PLUS - 990 F PLUS, CRONO 564-60, CRONO 574-70, CV 70 C - CV 70 N, CV 80 L - CV 80 M - CV 80 M, GRIMPER 555 L - N - ST, GRIMPER 560 L - N - ST - SST, GRIMPER 570 L - N - ST, PLUS 100 F, PLUS 55 F - 70 F, PLUS 75 F - 90 F	0.011.9073.3	
LUK500045900	Cuscinetto reggispinta 90 x 50 x 21,60 mm / Thrust Bearing 90 x 50 x 21,60 mm		880 F PLUS - 990 F PLUS, CRONO 554-50, CRONO 564-60, CRONO 574-70, CRONO 574-75, CV 70 C - CV 70 N, CV 80 L - CV 80 M - CV 80 M, GRIMPER 555/560/570, PLUS 100 F, PLUS 55 F - 70 F, PLUS 75 F - 90 F	2.2999.153.0, 2.2999.153.0/10, 2.2999.478.0	
LUK500005810	Cuscinetto pto 140 x 106 x 21 mm / Pto Bearing 140 x 106 x 21 mm		CV 70C - CV 70N, CV 80L - CV 80M, CV 80N, GRIMPER 555 L - N - ST, GRIMPER 560 L - N - SST - ST, GRIMPER 570 L - N - ST	2.2999.209.0	









## KIT FRIZIONE LUK 628302415

KIT EMBRAYAGE LUK 628302415

KIT CLUTCH LUK 628302415

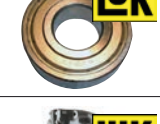
KIT KUPPLUNG LUK 628302415

KIT EMBRAGUE LUK 628302415

Art./Ref.	Note/Notes	Brand	Applicazione/Application	Rif. Orig./Orig. Ref.	Immagine/Image
LUK628302415	Kit tutto originale LUK composto da - Kit all LUK original consists of: - Meccanismo/Clutch Ref. 228 0209 11 - Disco Pto/Disc Pto 328 0377 11 - Cuscinetto/Bearing Ref. 500 0459 00 - Cuscinetto/Bearing Ref. 500 0284 00 - Cuscinetto/Bearing Ref. 410 0026 00	LAMBORGHINI	600 - 660 F PLUS, 700 - 775 F PLUS, 880 F PLUS - 990 F PLUS, PLUS 100 F - PLUS 55 F, PLUS 70 F - PLUS 75 F, PLUS 90 F	0.012.2574.4, 0.012.2574.4/10, 0.014.9428.3, 0.020.3544.4, 2.2021.018.0, 2.2999.478.0	    
85585	Meccanismo Frizione 11" - Luk originale/ Clutch 11" - Original Luk		880 F PLUS - 990 F PLUS, CRONO 564-60, CRONO 574-70, CV 70 C - CV 70 N, CV 80 L - CV 80 M - CV 80 M, GRIMPER 555 L - N - ST, GRIMPER 560 L - N - ST - SST, GRIMPER 570 L - N - ST, PLUS 100 F, PLUS 55 F - 70 F, PLUS 75 F - 90 F	0.012.2574.4, 0.012.2574.4/10, 0.020.3543.4, 0.020.3544.4	
LUK328037711	Disco Pto Diametro 280 mm Luk originale/Pto Disc Diameter 280 mm Original Luk		880 F PLUS - 990 F PLUS, CRONO 564-60, CRONO 574-70, CV 70 C - CV 70 N, CV 80 L - CV 80 M - CV 80 M, GRIMPER 555 L - N - ST, GRIMPER 560 L - N - ST - SST, GRIMPER 570 L - N - ST, PLUS 100 F, PLUS 55 F - 70 F, PLUS 75 F - 90 F	0.011.9073.3	
LUK500045900	Cuscinetto reggispinta 90 x 50 x 21,60 mm / Thrust Bearing 90 x 50 x 21,60 mm		880 F PLUS - 990 F PLUS, CRONO 554-50, CRONO 564-60, CRONO 574-70, CRONO 574-75, CV 70 C - CV 70 N, CV 80 L - CV 80 M - CV 80 M, GRIMPER 555/560/570, PLUS 100 F, PLUS 55 F - 70 F, PLUS 75 F - 90 F	2.2999.153.0, 2.2999.153.0/10, 2.2999.478.0	
LUK500028400	Cuscinetto pto 110 x 70 x 20 mm / Pto Bearing 110 x 70 x 20 mm		880 F PLUS - 990 F PLUS, CRONO 564-60, CRONO 574-70, CV 70 C - CV 70 N, CV 80 L - CV 80 M - CV 80 M, GRIMPER 555 L - N - ST, GRIMPER 560 L - N - ST - SST, GRIMPER 570 L - N - ST, PLUS 100 F, PLUS 55 F - 70 F, PLUS 75 F - 90 F	2.2021.018.0	



**MECCANISMO + DISCO AVANZAMENTO ORIGINALE LUK RIF. 628313109**

MECANISME + DISQUE AVANCEMENT ORIGINAL LUK 628313109  
 COVER ASSEMBLY + ORIGINAL MAIN DRIVE LUK REF. 628313109  
 GETRIEBE + VORSCHLEIBE LUK 628313109  
 MECANISMO + DISCO DE AVANCE ORIGINAL LUK REF. 628313109

Art./Ref.	Note/Notes	Brand	Applicazione/Application	Rif. Orig./Orig. Ref.	Immagine/Image
<b>LUK628313109</b>	Kit tutto originale LUK composto da - Kit all LUK original consists of: - Meccanismo/Clutch Ref. 128 0336 10 - Disco Avanzamento/Clutch Disc 328 0275 11	<b>LAMBORGHINI</b>	LAMBORGHINI 574-60 N CROSS, LAMBORGHINI 654-55 SPRINT, LAMBORGHINI 664-55 SPRINT, LAMBORGHINI 674-70 N CROSS, LAMBORGHINI 674-70 N CROSS BAS, LAMBORGHINI AGILE 660 S-V, LAMBORGHINI AGILE 770 S, LAMBORGHINI C635 - C65, LAMBORGHINI GRANDI PRIX 674-70, LAMBORGHINI LAMPO 55 W - 70 W, LAMBORGHINI R2.56, LAMBORGHINI R2.56 TARGET, LAMBORGHINI R2.66, LAMBORGHINI R2.66 TARGET, LAMBORGHINI RS73 - R674, LAMBORGHINI RF.55 - RF.70, LAMBORGHINI RS.70 - RV.70, LAMBORGHINI SPRINT 664-60	0.015.9286.3, 0.015.9287.3, 0.270.2330.3/10	

**MECCANISMO + DISCO AVANZAMENTO ORIGINALE LUK RIF. 631308219 - 631308209**

MECANISME + DISQUE AVANCEMENT ORIGINAL LUK 631308219 - 631308209  
 COVER ASSEMBLY + ORIGINAL MAIN DRIVE LUK REF. 631308219 - 631308209  
 GETRIEBE + VORSCHLEIBE LUK 631308219 - 631308209  
 MECANISMO + DISCO DE AVANCE ORIGINAL LUK REF. 631308219 - 631308209

Art./Ref.	Note/Notes	Brand	Applicazione/Application	Rif. Orig./Orig. Ref.	Immagine/Image	
<b>LUK631308219</b>	Kit tutto originale LUK composto da - Kit all LUK original consists of: - Meccanismo/Clutch Ref. 131 0228 10 - Disco Avanzamento a 6 pale/Clutch Disc 6 pairs of pads 331 0179 11	<b>LAMBORGHINI</b>	LAMBORGHINI 654.55 SPRINT, LAMBORGHINI 664.55 SPRINT, LAMBORGHINI 674-70N, LAMBORGHINI 674-70N CROSS, LAMBORGHINI 674-70N CROSS BASS, LAMBORGHINI 774, LAMBORGHINI AGILE 660S - 770S, LAMBORGHINI AGILE 775V, LAMBORGHINI AGILE 880S - 990S, LAMBORGHINI C674-70 ERGOMATIC, LAMBORGHINI C75, LAMBORGHINI C774-80 ERGOMATIC, LAMBORGHINI C874-90 ERGOMATIC, LAMBORGHINI CF100L - CF100N, LAMBORGHINI CF78L - CF78ST, LAMBORGHINI CF78N, LAMBORGHINI CF80N - CF80ST, LAMBORGHINI CF88L - CF88N, LAMBORGHINI CF88ST, LAMBORGHINI CF90L - CF90N, LAMBORGHINI CF90ST, LAMBORGHINI CF98L - CF98N, LAMBORGHINI CF98ST, LAMBORGHINI CROSS 674-75N, LAMBORGHINI GRAND PRIX 674-70, LAMBORGHINI GRAND PRIX 75TARGE, LAMBORGHINI GRAND PRIX 774-80, LAMBORGHINI GRAND PRIX 874-90T, LAMBORGHINI R2.76 - R2.76TARGE, LAMBORGHINI R2.86 - R2.86TARGE, LAMBORGHINI R3.75, LAMBORGHINI R3.75T - R3.75TB, LAMBORGHINI RF.100 - RF.55, LAMBORGHINI RF.70 - RF.75, LAMBORGHINI RF.90, LAMBORGHINI RS.100 - RS.70, LAMBORGHINI RS.75 - RS.90, LAMBORGHINI RV.100 - RV.70, LAMBORGHINI RV.75 - RV.90, LAMBORGHINI SPRINT 674-70, LAMBORGHINI SPRINT 675-75, LAMBORGHINI SPRINT 684-85, LAMBORGHINI TRIUMPH 80 - 90		0.015.9285.3, 0.015.9289.3	
<b>LUK631308209</b>	Kit tutto originale LUK composto da - Kit all LUK original consists of: - Meccanismo/Clutch Ref. 131 0228 10 - Disco Avanzamento/Clutch Disc 331 0179 10	<b>LAMBORGHINI</b>	LAMBORGHINI 654.55 SPRINT, LAMBORGHINI 664.55 SPRINT, LAMBORGHINI 674-70N, LAMBORGHINI 674-70N CROSS, LAMBORGHINI 674-70N CROSS BASS, LAMBORGHINI 774, LAMBORGHINI AGILE 660S - 770S, LAMBORGHINI AGILE 775V, LAMBORGHINI AGILE 880S - 990S, LAMBORGHINI C674-70 ERGOMATIC, LAMBORGHINI C75, LAMBORGHINI C774-80 ERGOMATIC, LAMBORGHINI C874-90 ERGOMATIC, LAMBORGHINI CF100L - CF100N, LAMBORGHINI CF78L - CF78ST, LAMBORGHINI CF78N, LAMBORGHINI CF80N - CF80ST, LAMBORGHINI CF88L - CF88N, LAMBORGHINI CF88ST, LAMBORGHINI CF90L - CF90N, LAMBORGHINI CF90ST, LAMBORGHINI CF98L - CF98N, LAMBORGHINI CF98ST, LAMBORGHINI CROSS 674-75N, LAMBORGHINI GRAND PRIX 674-70, LAMBORGHINI GRAND PRIX 75TARGE, LAMBORGHINI GRAND PRIX 774-80, LAMBORGHINI GRAND PRIX 874-90T, LAMBORGHINI R2.76 - R2.76TARGE, LAMBORGHINI R2.86 - R2.86TARGE, LAMBORGHINI R3.75, LAMBORGHINI R3.75T - R3.75TB, LAMBORGHINI RF.100 - RF.55, LAMBORGHINI RF.70 - RF.75, LAMBORGHINI RF.90, LAMBORGHINI RS.100 - RS.70, LAMBORGHINI RS.75 - RS.90, LAMBORGHINI RV.100 - RV.70, LAMBORGHINI RV.75 - RV.90, LAMBORGHINI SPRINT 674-70, LAMBORGHINI SPRINT 675-75, LAMBORGHINI SPRINT 684-85, LAMBORGHINI TRIUMPH 80 - 90		0.015.9285.3, 0.015.9288.3	

**MECCANISMO + DISCO AVANZAMENTO ORIGINALE LUK RIF. 633303109**

MECANISME + DISQUE AVANCEMENT ORIGINAL LUK 633303109  
 COVER ASSEMBLY + ORIGINAL MAIN DRIVE LUK REF. 633303109  
 GETRIEBE + VORSCHLEIBE LUK 633303109  
 MECANISMO + DISCO DE AVANCE ORIGINAL LUK 633303109

Art./Ref.	Note/Notes	Brand	Applicazione/Application	Rif. Orig./Orig. Ref.	Immagine/Image
<b>LUK633303109</b>	Kit tutto originale LUK composto da - Kit all LUK original consists of: - Meccanismo/Clutch Ref. 133 0259 10 - Disco Avanzamento a 5 pale/Clutch Disc 5 pairs of pads 333 0186 10	<b>LAMBORGHINI</b>	LAMBORGHINI C.100 - C.105, LAMBORGHINI C.90 - C.95, LAMBORGHINI R3 EVO 100, LAMBORGHINI R3.75 - R3.85, LAMBORGHINI R3.95, LAMBORGHINI R4.105 - R4.110, LAMBORGHINI R4.85 - R4.95, LAMBORGHINI TRIUMPH 100	0.012.7094.3, 0.012.7095.3/10	

**MECCANISMO + DISCO AVANZAMENTO ORIGINALE LUK RIF. 635304509**

MECANISME + DISQUE AVANCEMENT ORIGINAL LUK 635304509  
 COVER ASSEMBLY + ORIGINAL MAIN DRIVE LUK REF. 635304509  
 GETRIEBE + VORSCHLEIBE LUK 635304509  
 MECANISMO + DISCO DE AVANCE ORIGINAL LUK 635304509

Art./Ref.	Note/Notes	Brand	Applicazione/Application	Rif. Orig./Orig. Ref.	Immagine/Image
<b>LUK635304509</b>	Kit tutto originale LUK composto da - Kit all LUK original consists of: - Meccanismo/Clutch Ref. 135 0241 10 - Disco Avanzamento a 6 pale/Clutch Disc 6 pairs of pads 335 0186 10	<b>LAMBORGHINI</b>	LAMBORGHINI FORMULA 135, LAMBORGHINI PREMIUM 1300, LAMBORGHINI R5.115 - R5.130	0.008.5595.3, 0.008.5596.3	
<b>LUK500084630</b>	Cuscinetto reggispinta 90,60 x 55 x 22 mm / Thrust Bearing 90,60 x 55 x 22 mm		LAMBORGHINI 1106, LAMBORGHINI 1306, LAMBORGHINI 1506, LAMBORGHINI 774-80N, LAMBORGHINI 956, LAMBORGHINI FORMULA 105, LAMBORGHINI FORMULA 115, LAMBORGHINI FORMULA 135, LAMBORGHINI GRAND-PRIX 774-80, LAMBORGHINI GRAND-PRIX 874-90T, LAMBORGHINI PREMIUM 1050, LAMBORGHINI PREMIUM 1060, LAMBORGHINI PREMIUM 1300, LAMBORGHINI PREMIUM 850, LAMBORGHINI PREMIUM 950, LAMBORGHINI R5.115 - R5.130	2.2999.207.0, 2.2999.510.0	

**MECCANISMO + DISCO AVANZAMENTO ORIGINALE LUK RIF. 635351009**

MECANISME + DISQUE AVANCEMENT ORIGINAL LUK 635351009  
 COVER ASSEMBLY + ORIGINAL MAIN DRIVE LUK REF. 635351009  
 GETRIEBE + VORSCHLEIBE LUK 635351009  
 MECANISMO + DISCO DE AVANCE ORIGINAL LUK 635351009

Art./Ref.	Note/Notes	Brand	Applicazione/Application	Rif. Orig./Orig. Ref.	Immagine/Image
<b>LUK635351009</b>	Kit tutto originale LUK composto da - Kit all LUK original consists of: - Meccanismo/Clutch Ref. 135 0279 10 - Disco Avanzamento a 7 pale/Clutch Disc 7 pairs of pads 335 0321 10	<b>LAMBORGHINI</b>	LAMBORGHINI 1106 - 1306 - 1506, LAMBORGHINI 1706 - 956 - R1056, LAMBORGHINI R1106 - R1156, LAMBORGHINI R1256 - R1306, LAMBORGHINI R1356 - R1506, LAMBORGHINI R1556 - R906	0.014.0175.4, 0.014.0176.3	
<b>LUK500059730</b>	Cuscinetto reggispinta completo 111 x 65 x 30 mm / Bearing + carrier assy 111 x 65 x 30 mm		R 1306, R 1506	0.250.6533.3, 0.264.6533.3/20	
<b>LUK500084630</b>	Cuscinetto reggispinta 90,60 x 55 x 22 mm / Thrust Bearing 90,60 x 55 x 22 mm		LAMBORGHINI 1106, LAMBORGHINI 1306, LAMBORGHINI 1506, LAMBORGHINI 774-80N, LAMBORGHINI 956, LAMBORGHINI FORMULA 105, LAMBORGHINI FORMULA 115, LAMBORGHINI FORMULA 135, LAMBORGHINI GRAND-PRIX 774-80, LAMBORGHINI GRAND-PRIX 874-90T, LAMBORGHINI PREMIUM 1050, LAMBORGHINI PREMIUM 1060, LAMBORGHINI PREMIUM 1300, LAMBORGHINI PREMIUM 850, LAMBORGHINI PREMIUM 950, LAMBORGHINI R5.115 - R5.130	2.2999.207.0, 2.2999.510.0	





**KIT FRIZIONE LUK 625300710**

KIT EMBRAYAGE LUK 625300710

KIT CLUTCH LUK 625300710

KIT KUPPLUNG LUK 625300710

KIT EMBRAGUE LUK 625300710

Art./Ref.	Note/Notes	Brand	Applicazione/Application	Rif. Orig./Orig. Ref.	Immagine/Image
<b>LUK625300710</b>	Kit tutto originale LUK composto da - Kit all LUK original consists of: - Meccanismo/Clutch Ref. 225 0055 10 - Disco Pto/Disc Pto 323 0556 10 - Cuscinetto/Bearing Ref. 500 0459 00 - Cuscinetto/Bearing Ref. 500 0673 00 - Cuscinetto/Bearing Ref. 410 0026 00	<b>LAMBORGHINI</b>	LAMBORGHINI CRONO 55 TARGET, LAMBORGHINI CRONO F 55 TARGET	0.008.4743.4, 0.008.4744.3, 0.011.9063.3, 0.012.2564.4, 2.2021.018.0, 2.2999.153.0/10, 2.2999.478.0	
<b>LUK500045900</b>	Cuscinetto reggispinna 90 x 50 x 21,60 mm / Thrust Bearing 90 x 50 x 21,60 mm		880 F PLUS - 990 F PLUS, CRONO 554-50, CRONO 564-60, CRONO 574-70, CRONO 574-75, CV 70 C - CV 70 N, CV 80 L - CV 80 M - CV 80 M, GRIMPER 555/560/570, LAMBORGHINI CRONO 55 TARGET, LAMBORGHINI CRONO F 55 TARGET, PLUS 100 F, PLUS 55 F - 70 F, PLUS 75 F - 90 F	2.2999.153.0, 2.2999.153.0/10, 2.2999.478.0	
<b>LUK500067300</b>	Cuscinetto pto 100 x 65 x 18 mm / Pto Bearing 100 x 65 x 18 mm		LAMBORGHINI CRONO 55 TARGET, LAMBORGHINI CRONO F 55 TARGET	2.2021.017.0	

**KIT FRIZIONE LUK 631107510**

KIT EMBRAYAGE LUK 631107510

KIT CLUTCH LUK 631107510

KIT KUPPLUNG LUK 631107510

KIT EMBRAGUE LUK 631107510

Art./Ref.	Note/Notes	Brand	Applicazione/Application	Rif. Orig./Orig. Ref.	Immagine/Image
<b>LUK631107510</b>	Kit tutto originale LUK composto da - Kit all LUK original consists of: - Meccanismo/Clutch Ref. 131 0229 10 - Disco avanzamento/Disc clutch 331 0184 10 - Cuscinetto/Bearing Ref. 500 0076 11	<b>LAMBORGHINI</b>	LAMBORGHINI 574-60 N CROSS, LAMBORGHINI 674-60 N, LAMBORGHINI 674-60 N CROSS, LAMBORGHINI 674-60 N CROSS BAS, LAMBORGHINI AGILE 660S, LAMBORGHINI AGILE 770S, LAMBORGHINI AGILE 880S, LAMBORGHINI AGILE 990S, LAMBORGHINI C874-90 ERGOMATIC, LAMBORGHINI FORMULA 105, LAMBORGHINI GRAND PRIX 674-70, LAMBORGHINI GRAND PRIX 874-90T, LAMBORGHINI SPRINT 664-60, LAMBORGHINI SPRINT 674-70	0.014.9424.3, 0.014.9433.3, 2.2999.475.0	

**MECCANISMO + DISCO AVANZAMENTO ORIGINALE LUK RIF. 633312310 - 633312300**

MECANISME + DISQUE AVANCEMENT ORIGINAL LUK 633312310 - 633312300

COVER ASSEMBLY + ORIGINAL MAIN DRIVE LUK REF. 633312310 - 633312300

GETRIEBE + VORSCHLEIBE LUK 633312310 - 633312300

MECANISMO + DISCO DE AVANCE ORIGINAL LUK REF. 633312310 - 633312300

Art./Ref.	Note/Notes	Brand	Applicazione/Application	Rif. Orig./Orig. Ref.	Immagine/Image
<b>LUK633312310</b>	Kit tutto originale LUK composto da - Kit all LUK original consists of: - Meccanismo/Clutch Ref. 133 0279 10 - Disco avanzamento a 6 pale/Disc clutch 6 pairs of pads 333 0116 10 - Cuscinetto/Bearing Ref. 500 0846 30		LAMBORGHINI 774-80 N, LAMBORGHINI FORMULA 105 - 135, LAMBORGHINI GRAND PRIX 774-80, LAMBORGHINI GRAND PRIX 874-90T, LAMBORGHINI PREMIUM 1050, LAMBORGHINI PREMIUM 1060, LAMBORGHINI PREMIUM 850 - 950	0.008.4184.3, 0.014.9423.3/10, 0.016.6105.3, 2.2999.207.0, 2.2999.510.0	
<b>LUK633312300</b>	Kit tutto originale LUK composto da - Kit all LUK original consists of: - Meccanismo/Clutch Ref. 133 0279 10 - Disco avanzamento/Disc clutch 333 0117 10 - Cuscinetto/Bearing Ref. 500 0846 30	<b>LAMBORGHINI</b>	LAMBORGHINI 774-80 N, LAMBORGHINI FORMULA 105 - 135, LAMBORGHINI GRAND PRIX 774-80, LAMBORGHINI GRAND PRIX 874-90T, LAMBORGHINI PREMIUM 1050, LAMBORGHINI PREMIUM 1060, LAMBORGHINI PREMIUM 850 - 950	0.008.4184.3, 0.014.9423.3/10, 0.014.9431.3, 2.2999.207.0, 2.2999.510.0	
<b>LUK500084630</b>	Cuscinetto reggispira 90,60 x 55 x 22 mm / Thrust Bearing 90,60 x 55 x 22 mm		LAMBORGHINI 1106, LAMBORGHINI 1306, LAMBORGHINI 1506, LAMBORGHINI 774-80N, LAMBORGHINI 956, LAMBORGHINI FORMULA 105, LAMBORGHINI FORMULA 115, LAMBORGHINI FORMULA 135, LAMBORGHINI GRAND-PRIX 774-80, LAMBORGHINI GRAND-PRIX 874-90T, LAMBORGHINI PREMIUM 1050, LAMBORGHINI PREMIUM 1060, LAMBORGHINI PREMIUM 1300, LAMBORGHINI PREMIUM 850, LAMBORGHINI PREMIUM 950, LAMBORGHINI R5.115 - R5.130	2.2999.207.0, 2.2999.510.0	

**MECCANISMO + DISCO AVANZAMENTO ORIGINALE LUK RIF. 635353510 - 635353810**

MECANISME + DISQUE AVANCEMENT ORIGINAL LUK 635353510 - 635353810

COVER ASSEMBLY + ORIGINAL MAIN DRIVE LUK REF. 635353510 - 635353810

GETRIEBE + VORSCHLEIBE LUK 635353510 - 635353810

MECANISMO + DISCO DE AVANCE ORIGINAL LUK REF. 635353510 - 635353810

Art./Ref.	Note/Notes	Brand	Applicazione/Application	Rif. Orig./Orig. Ref.	Immagine/Image
<b>LUK635353510</b>	Kit tutto originale LUK composto da - Kit all LUK original consists of: - Meccanismo/Clutch Ref. 135 0284 10 - Disco avanzamento 330 mm Z24/Disc clutch 330 mm Z24 333 0215 10 - Cuscinetto/Bearing Ref. 500 0076 11	<b>LAMBORGHINI</b>	LAMBORGHINI 774-80N, LAMBORGHINI GRAND PRIX 774-80, LAMBORGHINI GRAND PRIX 874-90T, LAMBORGHINI PREMIUM 1050, LAMBORGHINI PREMIUM 1060, LAMBORGHINI PREMIUM 850 - 950	0.015.6381.3, 0.015.6386.3, 2.2999.475.0	

Art./Ref.	Note/Notes	Brand	Applicazione/Application	Rif. Orig./Orig. Ref.	Immagine/Image
<b>LUK635353810</b>	Kit tutto originale LUK composto da - Kit all LUK original consists of: - Meccanismo/Clutch Ref. 135 0284 10 - Disco avanzamento 350 mm Z24/Disc clutch 350 mm Z24 335 0337 10 - Cuscinetto/Bearing Ref. 500 0076 11	<b>LAMBORGHINI</b>	LAMBORGHINI 774-80N, LAMBORGHINI GRAND PRIX 774-80, LAMBORGHINI GRAND PRIX 874-90T, LAMBORGHINI PREMIUM 1050, LAMBORGHINI PREMIUM 1060, LAMBORGHINI PREMIUM 850 - 950	0.015.6328.3, 0.015.6386.3, 2.2999.475.0	

**MECCANISMO + DISCO AVANZAMENTO ORIGINALE LUK RIF. 635353910**
*MECANISME + DISQUE AVANCEMENT ORIGINAL LUK 635353910*
*COVER ASSEMBLY + ORIGINAL MAIN DRIVE LUK REF. 635353910*
*GETRIEBE + VORSCHLEIBE LUK 635353910*
*MECCANISMO + DISCO DE AVANCE ORIGINAL LUK REF. 635353910*

Art./Ref.	Note/Notes	Brand	Applicazione/Application	Rif. Orig./Orig. Ref.	Immagine/Image
<b>LUK635353910</b>	Kit tutto originale LUK composto da - Kit all LUK original consists of: - Meccanismo/Clutch Ref. 135 0284 10 - Disco avanzamento 350 mm Z21/Disc clutch 350 mm Z21 335 0338 10 - Cuscinetto/Bearing Ref. 500 0076 11	<b>LAMBORGHINI</b>	LAMBORGHINI FORMULA 115, LAMBORGHINI PREMIUM 1100	0.007.7930.3/10, 0.015.6386.3, 2.2999.475.0	

**KIT FRIZIONE LUK ORIGINALE RIF. MECCANISMO 0.014.9017.3**
*KIT EMBRAYAGE LUK ORIGINAL REF. 0.014.9017.3*
*KIT CLUTCH ORIGINAL LUK REF. 0.014.9017.3*
*KIT KUPPLUNG LUK REF. 0.014.9017.3*
*KIT EMBRAGUE LUK ORIGINAL REF. 0.014.9017.3*

Art./Ref.	Note/Notes	Brand	Applicazione/Application	Rif. Orig./Orig. Ref.	Immagine/Image
<b>LUK131031210</b>	Meccanismo Frizione 12" - Luk originale/ Embayage 12" - Original Luk/Clutch 12" - Original Luk/Kupplung 12" - Luk/Embrague 12" - Original Luk	<b>LAMBORGHINI</b>	LAMBORGHINI R 3 EVO 85	0.014.9017.3	
<b>LUK331034610</b>	Disco avanzamento 310 mm a 6 pale Luk originale/Clutch Disc Diameter 310 mm 6 pairs of pads Original Luk		LAMBORGHINI R 3 EVO 85	0.014.9016.3	

**KIT FRIZIONE LUK ORIGINALE RIF. MECCANISMO 0.016.6106.3**
*KIT EMBRAYAGE LUK ORIGINAL REF. 0.016.6106.3*
*KIT CLUTCH ORIGINAL LUK REF. 0.016.6106.3*
*KIT KUPPLUNG LUK REF. 0.016.6106.3*
*KIT EMBRAGUE LUK ORIGINAL REF. 0.016.6106.3*

Art./Ref.	Note/Notes	Brand	Applicazione/Application	Rif. Orig./Orig. Ref.	Immagine/Image
<b>LUK135028510</b>	Meccanismo Frizione 14" - Luk originale/Clutch 14" - Original Luk	<b>LAMBORGHINI</b>	LAMBORGHINI CROSS 774-85 N, LAMBORGHINI CROSS 874-95 N, LAMBORGHINI FORMULA 115, LAMBORGHINI GRAND PRIX 95 TARG, LAMBORGHINI HIGH CLEARANCE 90, LAMBORGHINI PREMIUM 1100, LAMBORGHINI R3.75 - R3.85, LAMBORGHINI R3.85 T - R3.85 TB, LAMBORGHINI R3.95 - R3.95 T, LAMBORGHINI R3.95 TB, LAMBORGHINI R4.105, LAMBORGHINI R4.110 - R4.85, LAMBORGHINI R4.95	0.016.6106.3	
<b>LUK333011610</b>	Disco avanzamento 330 mm a 6 pale Luk originale /Clutch Disc Diameter 330 mm 6 pairs of pads Original Luk		LAMBORGHINI CROSS 774-85 N, LAMBORGHINI CROSS 874-95 N, LAMBORGHINI FORMULA 115, LAMBORGHINI GRAND PRIX 95 TARG, LAMBORGHINI HIGH CLEARANCE 90, LAMBORGHINI PREMIUM 1100, LAMBORGHINI R3.75 - R3.85, LAMBORGHINI R3.85 T - R3.85 TB, LAMBORGHINI R3.95 - R3.95 T, LAMBORGHINI R3.95 TB, LAMBORGHINI R4.105, LAMBORGHINI R4.110 - R4.85, LAMBORGHINI R4.95	0.016.6105.3	

**KIT FRIZIONE ADATTABILE RIF. 628302415 SDF**

KIT EMBRAYAGE ADAPTABLE REF. 628302415 SDF

KIT CLUTCH ADAPTABLE REF. 628302415 SDF

KIT KUPPLUNG PASSEND ZU REF. 628302415 SDF

KIT EMBRAGUE ADAPTABLE REF. 628302415 SDF

Art./Ref.	Note/Notes	Brand	Applicazione/Application	Rif. Orig./Orig. Ref.	Immagine/Image
<b>85586</b>	<p>Kit composto da - Kit consists of:</p> <ul style="list-style-type: none"> <li>- Meccanismo/Clutch Ref. 0.012.2574.4 With box Original SDF</li> <li>- Disco Pto/Disc Pto Ref. 0.014.9428.3 Not Original</li> <li>- Cuscinetto/Bearing Ref. 2.2999.478.0 Not Original</li> <li>- Cuscinetto/Bearing Ref. 2.2021.018.0 Not Original</li> </ul>	<b>SAME</b>	<p>ASTER 60 - 70, FRUTTETO II 100, FRUTTETO II 55, FRUTTETO II 60, FRUTTETO II 70, FRUTTETO II 75, FRUTTETO II 85, FRUTTETO II 90, SOLAR 60</p>	<p>0.012.2574.4, 0.012.2574.4/10, 0.014.9428.3, 0.020.3544.4, 2.2021.018.0, 2.2999.478.0</p>	
<b>VO.012.2574.4</b>	<p>Meccanismo Frizione 11" - Sdf originale/ Clutch 11" - Original Sdf</p>		<p>ARGON 60 - 70, FRUTTETO II 100, FRUTTETO II 55, FRUTTETO II 70, FRUTTETO II 75, FRUTTETO II 85, FRUTTETO II 90, FRUTTETO III 100 CLASSIC, FRUTTETO III 90 CLASSIC, KRYPTON V 70 C, KRYPTON V 70 N, KRYPTON V 80 L, KRYPTON V 80 M, KRYPTON V 80 N, ROCK 55, ROCK 60, ROCK 70</p>	<p>0.012.2574.4, 0.012.2574.4/10, 0.020.3543.4, 0.020.3544.4</p>	
<b>85474</b>	<p>Disco Pto Diametro 280 mm / Pto Disc Diameter 280 mm</p>		<p>ARGON 60 - 70, FRUTTETO II 100, FRUTTETO II 55, FRUTTETO II 70, FRUTTETO II 75, FRUTTETO II 85, FRUTTETO II 90, FRUTTETO III 100 CLASSIC, FRUTTETO III 90 CLASSIC, KRYPTON V 70 C, KRYPTON V 70 N, KRYPTON V 80 L, KRYPTON V 80 M, KRYPTON V 80 N, ROCK 55, ROCK 60, ROCK 70</p>	<p>0.014.9428.3</p>	
<b>12841</b>	<p>Cuscinetto reggispinta 90 x 50 x 21,60 mm / Thrust Bearing 90 x 50 x 21,60 mm</p>		<p>ARGON 50/55/55F/60/70/75F/70CL, ASTER 60/70, FRUTTETO 60/75, FRUTTETO 60II/75II/85II, KRYPTON V70/V80, ROCK 55/60/70</p>	<p>2.299.153.0/1, 2.2999.153.0, 2.2999.153.0/1, 2.2999.153.0/10, 2.2999.478.0</p>	
<b>14882</b>	<p>Cuscinetto pto 110 x 70 x 20 mm / Pto Bearing 110 x 70 x 20 mm</p>		<p>ASTER 60 - 70, FRUTTETO II 100, FRUTTETO II 55, FRUTTETO II 70, FRUTTETO II 75, FRUTTETO II 85, FRUTTETO II 90, LEOPARD 85 C, SOLAR 50 - 55 C - 60 - 60 C, SOLAR 60 COMPACT HD</p>	<p>2.2021.018.0</p>	
<b>85587</b>	<p>Kit composto da - Kit consists of:</p> <ul style="list-style-type: none"> <li>- Meccanismo/Clutch Ref. 0.012.2574.4 With box Original LUK</li> <li>- Disco Pto/Disc Pto Ref. 0.014.9428.3 Not Original</li> <li>- Cuscinetto/Bearing Ref. 2.2999.478.0 Not Original</li> <li>- Cuscinetto/Bearing Ref. 2.2021.018.0 Not Original</li> </ul>		<b>SAME</b>	<p>ASTER 60 - 70, FRUTTETO II 100, FRUTTETO II 55, FRUTTETO II 60, FRUTTETO II 70, FRUTTETO II 75, FRUTTETO II 85, FRUTTETO II 90, SOLAR 60</p>	<p>0.012.2574.4, 0.012.2574.4/10, 0.014.9428.3, 0.020.3544.4, 2.2021.018.0, 2.2999.478.0</p>

Art./Ref.	Note/Notes	Brand	Applicazione/Application	Rif. Orig./Orig. Ref.	Immagine/Image
85585	Meccanismo Frizione 11" - Luk originale/ Clutch 11" - Original Luk	SAME	ARGON 60 - 70, FRUTTETO II 100, FRUTTETO II 55, FRUTTETO II 70, FRUTTETO II 75, FRUTTETO II 85, FRUTTETO II 90, FRUTTETO III 100 CLASSIC, FRUTTETO III 90 CLASSIC, KRYPTON V 70 C, KRYPTON V 70 N, KRYPTON V 80 L, KRYPTON V 80 M, KRYPTON V 80 N, ROCK 55, ROCK 60, ROCK 70	0.012.2574.4, 0.012.2574.4/10, 0.020.3543.4, 0.020.3544.4	
85474	Disco Pto Diametro 280 mm/Pto Disc Diameter 280 mm		ARGON 60 - 70, FRUTTETO II 100, FRUTTETO II 55, FRUTTETO II 70, FRUTTETO II 75, FRUTTETO II 85, FRUTTETO II 90, FRUTTETO III 100 CLASSIC, FRUTTETO III 90 CLASSIC, KRYPTON V 70 C, KRYPTON V 70 N, KRYPTON V 80 L, KRYPTON V 80 M, KRYPTON V 80 N, ROCK 55, ROCK 60, ROCK 70	0.014.9428.3	
12841	Cuscinetto reggispinta 90 x 50 x 21,60 mm / Thrust Bearing 90 x 50 x 21,60 mm		ARGON 50/55/55F/60/70/75F/70CL, ASTER 60/70,FRUTTETO 60/75, FRUTTETO 60II/75II/85II, KRYPTON V70/V80, ROCK 55/60/70	2.299.153.0/1, 2.2999.153.0, 2.2999.153.0/1, 2.2999.153.0/10, 2.2999.478.0	
14882	Cuscinetto pto 110 x 70 x 20 mm / Pto Bearing 110 x 70 x 20 mm		ASTER 60 - 70, FRUTTETO II 100, FRUTTETO II 55, FRUTTETO II 70, FRUTTETO II 75, FRUTTETO II 85, FRUTTETO II 90, LEOPARD 85 C, SOLAR 50 - 55 C - 60 - 60 C, SOLAR 60 COMPACT HD	2.2021.018.0	

**KIT FRIZIONE LUK 628302414**

KIT EMBRAYAGE LUK 628302414

KIT CLUTCH LUK 628302414

KIT KUPPLUNG LUK 628302414

KIT EMBRAGUE LUK 628302414

Art./Ref.	Note/Notes	Brand	Applicazione/Application	Rif. Orig./Orig. Ref.	Immagine/Image
LUK628302414	Kit tutto originale LUK composto da - Kit all LUK original consists of: - Meccanismo/Clutch Ref. 228 0209 11 - Disco Pto/Disc Pto 328 0377 11 - Cuscinetto/Bearing Ref. 500 0459 00 - Cuscinetto/Bearing Ref. 500 0058 10 - Cuscinetto/Bearing Ref. 410 0026 00	SAME	FRUTTETO 60 - 75, KRYPTON V 70 C - N, KRYPTON V 80 L - M - N, ROCK 55 - 60 - 70, VIGNERON 62 - 75	0.012.2574.0, 0.012.2574.4, 0.012.2574.4/10, 0.014.9428.3, 0.020.3544.4, 2.2999.209.0, 2.2999.478.0	   
85585	Meccanismo Frizione 11" - Luk originale/ Clutch 11" - Original Luk		ARGON 60 - 70, FRUTTETO II 100, FRUTTETO II 55, FRUTTETO II 70, FRUTTETO II 75, FRUTTETO II 85, FRUTTETO II 90, FRUTTETO III 100 CLASSIC, FRUTTETO III 90 CLASSIC, KRYPTON V 70 C, KRYPTON V 70 N, KRYPTON V 80 L, KRYPTON V 80 M, KRYPTON V 80 N, ROCK 55, ROCK 60, ROCK 70	0.012.2574.4, 0.012.2574.4/10, 0.020.3543.4, 0.020.3544.4	
LUK328037711	Disco Pto Diametro 280 mm Luk originale/Pto Disc Diameter 280 mm Original Luk		ARGON 60 - 70, FRUTTETO II 100, FRUTTETO II 55, FRUTTETO II 70, FRUTTETO II 75, FRUTTETO II 85, FRUTTETO II 90, FRUTTETO III 100 CLASSIC, FRUTTETO III 90 CLASSIC, KRYPTON V 70 C, KRYPTON V 70 N, KRYPTON V 80 L, KRYPTON V 80 M, KRYPTON V 80 N, ROCK 55, ROCK 60, ROCK 70	0.011.9073.3	

Art./Ref.	Note/Notes	Brand	Applicazione/Application	Rif. Orig./Orig. Ref.	Immagine/Image
<b>LUK500045900</b>	Cuscinetto reggispinta 90 x 50 x 21,60 mm / Thrust Bearing 90 x 50 x 21,60 mm	<b>SAME</b>	ARGON 50/55/55F/60/70/75F/70CL, ASTER 60/70,FRUTTETO 60/75, FRUTTETO 60II/75II/85II, KRYPTON V70/V80, ROCK 55/60/70	2.299.153.0/1, 2.2999.153.0, 2.2999.153.0/1, 2.2999.153.0/10, 2.2999.478.0	
<b>LUK500005810</b>	Cuscinetto pto 140 x 106 x 21 mm / Pto Bearing 140 x 106 x 21 mm		FRUTTETO 60 - 75, KRYPTON V 70 C - N, KRYPTON V 80 L - M - N, ROCK 55 - 60 - 70, VIGNERON 62 - 75	2.2999.209.0	

**KIT FRIZIONE LUK 628302415**

KIT EMBRAYAGE LUK 628302415

KIT CLUTCH LUK 628302415

KIT KUPPLUNG LUK 628302415

KIT EMBRAGUE LUK 628302415

Art./Ref.	Note/Notes	Brand	Applicazione/Application	Rif. Orig./Orig. Ref.	Immagine/Image
<b>LUK628302415</b>	Kit tutto originale LUK composto da - Kit all LUK original consists of: - Meccanismo/Clutch Ref. 228 0209 11 - Disco Pto/Disc Pto 328 0377 11 - Cuscinetto/Bearing Ref. 500 0459 00 - Cuscinetto/Bearing Ref. 500 0284 00 - Cuscinetto/Bearing Ref. 410 0026 00	<b>SAME</b>	ASTER 60 - 70, FRUTTETO II 100, FRUTTETO II 55, FRUTTETO II 60, FRUTTETO II 70, FRUTTETO II 75, FRUTTETO II 85, FRUTTETO II 90, SOLAR 60	0.012.2574.4, 0.012.2574.4/10, 0.014.9428.3, 0.020.3544.4, 2.2021.018.0, 2.2999.478.0	    
<b>85585</b>	Meccanismo Frizione 11" - Luk originale/ Clutch 11" - Original Luk		ARGON 60 - 70, FRUTTETO II 100, FRUTTETO II 55, FRUTTETO II 70, FRUTTETO II 75, FRUTTETO II 85, FRUTTETO II 90, FRUTTETO III 100 CLASSIC, FRUTTETO III 90 CLASSIC, KRYPTON V 70 C, KRYPTON V 70 N, KRYPTON V 80 L, KRYPTON V 80 M, KRYPTON V 80 N, ROCK 55, ROCK 60, ROCK 70	0.012.2574.4, 0.012.2574.4/10, 0.020.3543.4, 0.020.3544.4	
<b>LUK328037711</b>	Disco Pto Diametro 280 mm Luk originale/Pto Disc Diameter 280 mm Original Luk		ARGON 60 - 70, FRUTTETO II 100, FRUTTETO II 55, FRUTTETO II 70, FRUTTETO II 75, FRUTTETO II 85, FRUTTETO II 90, FRUTTETO III 100 CLASSIC, FRUTTETO III 90 CLASSIC, KRYPTON V 70 C, KRYPTON V 70 N, KRYPTON V 80 L, KRYPTON V 80 M, KRYPTON V 80 N, ROCK 55, ROCK 60, ROCK 70	0.011.9073.3	
<b>LUK500045900</b>	Cuscinetto reggispinta 90 x 50 x 21,60 mm / Thrust Bearing 90 x 50 x 21,60 mm		ARGON 50/55/55F/60/70/75F/70CL, ASTER 60/70,FRUTTETO 60/75, FRUTTETO 60II/75II/85II, KRYPTON V70/V80, ROCK 55/60/70	2.299.153.0/1, 2.2999.153.0, 2.2999.153.0/1, 2.2999.153.0/10, 2.2999.478.0	
<b>LUK500028400</b>	Cuscinetto pto 110 x 70 x 20 mm / Pto Bearing 110 x 70 x 20 mm		ASTER 60 - 70, FRUTTETO II 100, FRUTTETO II 55	2.2021.018.0	



**MECCANISMO + DISCO AVANZAMENTO ORIGINALE LUK RIF. 628313109**

MECANISME + DISQUE AVANCEMENT ORIGINAL LUK 628313109  
 COVER ASSEMBLY + ORIGINAL MAIN DRIVE LUK REF. 628313109  
 GETRIEBE + VORSCHLEIBE LUK 628313109  
 MECANISMO + DISCO DE AVANCE ORIGINAL LUK REF. 628313109

Art./Ref.	Note/Notes	Brand	Applicazione/Application	Rif. Orig./Orig. Ref.	Immagine/Image
<b>LUK628313109</b>	Kit tutto originale LUK composto da - Kit all LUK original consists of: - Meccanismo/Clutch Ref. 128 0336 10 - Disco Avanzamento/Clutch Disc 328 0275 11	<b>SAME</b>	SAME 65, SAME DORADO 55 - 56, SAME DORADO 56 CLASSIC, SAME DORADO 60 - 65 - 66, SAME DORADO 66 CLASSIC, SAME DORADO F55 - F70, SAME DORADO S70 - V70, SAME EXPLORER 55 - 60, SAME EXPLORER 60 SPECIAL, SAME EXPLORER 65 - 65C, SAME EXPLORER 65 SPECIAL, SAME EXPLORER 70, SAME EXPLORER II 60, SAME EXPLORER II 60 SPECIAL, SAME EXPLORER II 70, SAME EXPLORER II 70 SPECIAL, SAME GOLDEN 60 COMPATTO, SAME GOLDEN 60 V, SAME GOLDEN 65 COMPATTO, SAME ROLLER 55W - 70W	0.015.9286.3, 0.015.9287.3, 0.270.2330.3/10	

**MECCANISMO + DISCO AVANZAMENTO ORIGINALE LUK RIF. 631308219 - 631308209**

MECANISME + DISQUE AVANCEMENT ORIGINAL LUK 631308219 - 631308209  
 COVER ASSEMBLY + ORIGINAL MAIN DRIVE LUK REF. 631308219 - 631308209  
 GETRIEBE + VORSCHLEIBE LUK 631308219 - 631308209  
 MECANISMO + DISCO DE AVANCE ORIGINAL LUK REF. 631308219 - 631308209

Art./Ref.	Note/Notes	Brand	Applicazione/Application	Rif. Orig./Orig. Ref.	Immagine/Image
<b>LUK631308219</b>	Kit tutto originale LUK composto da - Kit all LUK original consists of: - Meccanismo/Clutch Ref. 131 0228 10 - Disco Avanzamento a 6 pale/Clutch Disc 6 pairs of pads 331 0179 11	<b>SAME</b>	SAME DORADO 55 - 56 - 65 - 66, SAME DORADO 70 - 75 - 76, SAME DORADO 76 CLASSIC, SAME DORADO 85 - 86, SAME DORADO 86 CLASSIC, SAME DORADO F100 - F55 - F70, SAME DORADO F75 - F90, SAME DORADO S100 - S70 - S75, SAME DORADO S90, SAME DORADO V100 - V70 - V75, SAME DORADO V90, SAME EXPLORER 70 SPECIAL, SAME EXPLORER 75, SAME EXPLORER 75 CLASSIC, SAME EXPLORER 75 SPECIAL, SAME EXPLORER 75 T - 75 TB, SAME EXPLORER 80, SAME EXPLORER 90 C TURBO, SAME EXPLORER 90 TURBO, SAME EXPLORER II 70, SAME EXPLORER II 70 SPECIAL, SAME EXPLORER II 70 SPECIAL BA, SAME EXPLORER II 75 SPECIAL, SAME EXPLORER II 80 - II 80 LP, SAME EXPLORER II 80 SPECIAL BA, SAME EXPLORER II 80 SPECIAL LP, SAME EXPLORER II 90 T, SAME GOLDEN 60 COMPATTO, SAME GOLDEN 60 V, SAME GOLDEN 65 COMPATTO, SAME GOLDEN 75 COMPATTO, SAME GOLDEN 75 V, SAME GOLDEN 85 COMPATTO, SAME KRYPTON 80 - 90, SAME KRYPTON F100 M-N, SAME KRYPTON F78 C-M-N, SAME KRYPTON F80 C-N, SAME KRYPTON F88 C-M-N, SAME KRYPTON F90 C-M-N, SAME KRYPTON F98 C-M-N	0.015.9285.3, 0.015.9289.3	
<b>LUK631308209</b>	Kit tutto originale LUK composto da - Kit all LUK original consists of: - Meccanismo/Clutch Ref. 131 0228 10 - Disco Avanzamento/Clutch Disc 331 0179 10		SAME DORADO 55 - 56 - 65 - 66, SAME DORADO 70 - 75 - 76, SAME DORADO 76 CLASSIC, SAME DORADO 85 - 86, SAME DORADO 86 CLASSIC, SAME DORADO F100 - F55 - F70, SAME DORADO F75 - F90, SAME DORADO S100 - S70 - S75, SAME DORADO S90, SAME DORADO V100 - V70 - V75, SAME DORADO V90, SAME EXPLORER 70 SPECIAL, SAME EXPLORER 75, SAME EXPLORER 75 CLASSIC, SAME EXPLORER 75 SPECIAL, SAME EXPLORER 75 T - 75 TB, SAME EXPLORER 80, SAME EXPLORER 90 C TURBO, SAME EXPLORER 90 TURBO, SAME EXPLORER II 70, SAME EXPLORER II 70 SPECIAL, SAME EXPLORER II 70 SPECIAL BA, SAME EXPLORER II 75 SPECIAL, SAME EXPLORER II 80 - II 80 LP, SAME EXPLORER II 80 SPECIAL BA, SAME EXPLORER II 80 SPECIAL LP, SAME EXPLORER II 90 T, SAME GOLDEN 60 COMPATTO, SAME GOLDEN 60 V, SAME GOLDEN 65 COMPATTO, SAME GOLDEN 75 COMPATTO, SAME GOLDEN 75 V, SAME GOLDEN 85 COMPATTO, SAME KRYPTON 80 - 90, SAME KRYPTON F100 M-N, SAME KRYPTON F78 C-M-N, SAME KRYPTON F80 C-N, SAME KRYPTON F88 C-M-N, SAME KRYPTON F90 C-M-N, SAME KRYPTON F98 C-M-N	0.015.9285.3, 0.015.9288.3	

**MECCANISMO + DISCO AVANZAMENTO ORIGINALE LUK RIF. 633303109**

MECANISME + DISQUE AVANCEMENT ORIGINAL LUK 633303109  
 COVER ASSEMBLY + ORIGINAL MAIN DRIVE LUK REF. 633303109  
 GETRIEBE + VORSCHLEIBE LUK 633303109  
 MECANISMO + DISCO DE AVANCE ORIGINAL LUK 633303109

Art./Ref.	Note/Notes	Brand	Applicazione/Application	Rif. Orig./Orig. Ref.	Immagine/Image
<b>LUK633303109</b>	Kit tutto originale LUK composto da - Kit all LUK original consists of: - Meccanismo/Clutch Ref. 133 0259 10 - Disco Avanzamento a 5 pale/Clutch Disc 5 pairs of pads 333 0186 10	<b>SAME</b>	SAME EXPLORER 3 100 - 3 100 T, SAME EXPLORER 3 100 TB, SAME EXPLORER 75 - 85 - 95, SAME KRYPTON 100 - 105, SAME KRYPTON 90 - 95, SAME SILVER 105 - 110, SAME SILVER 85 - 95	0.012.7094.3, 0.012.7095.3/10	

**MECCANISMO + DISCO AVANZAMENTO ORIGINALE LUK RIF. 635304509**

MECANISME + DISQUE AVANCEMENT ORIGINAL LUK 635304509  
 COVER ASSEMBLY + ORIGINAL MAIN DRIVE LUK REF. 635304509  
 GETRIEBE + VORSCHLEIBE LUK 635304509  
 MECANISMO + DISCO DE AVANCE ORIGINAL LUK 635304509

Art./Ref.	Note/Notes	Brand	Applicazione/Application	Rif. Orig./Orig. Ref.	Immagine/Image
<b>LUK635304509</b>	Kit tutto originale LUK composto da - Kit all LUK original consists of: - Meccanismo/Clutch Ref. 135 0241 10 - Disco Avanzamento a 6 pale/Clutch Disc 6 pairs of pads 335 0186 10	<b>SAME</b>	SAME ANTARES 110 - 130, SAME ANTARES II 130, SAME SILVER 115 - 130	0.008.5595.3, 0.008.5596.3	
<b>LUK500084630</b>	Cuscinetto reggispinta 90,60 x 55 x 22 mm / Thrust Bearing 90,60 x 55 x 22 mm		SAME ANTARES 100, SAME ANTARES 110 - 130, SAME ANTARES II 110, SAME ANTARES II 130, SAME EXPLORER 100 SPECIAL LP, SAME EXPLORER 80 SPECIAL, SAME EXPLORER 80 SPECIAL LP, SAME EXPLORER 90 SPECIAL, SAME EXPLORER 90 SPECIAL LP, SAME EXPLORER II 80, SAME EXPLORER II 80 LP, SAME EXPLORER II 80 TOP, SAME EXPLORER II 90 T, SAME GALAXY 170, SAME LASER 170, SAME ROW CROP 90, SAME SILVER 100.4, SAME SILVER 100.6, SAME SILVER 115 - 130, SAME SILVER 80, SAME SILVER 90	2.2999.207.0, 2.2999.510.0	

**MECCANISMO + DISCO AVANZAMENTO ORIGINALE LUK RIF. 635351009**

MECANISME + DISQUE AVANCEMENT ORIGINAL LUK 635351009  
 COVER ASSEMBLY + ORIGINAL MAIN DRIVE LUK REF. 635351009  
 GETRIEBE + VORSCHLEIBE LUK 635351009  
 MECANISMO + DISCO DE AVANCE ORIGINAL LUK 635351009

Art./Ref.	Note/Notes	Brand	Applicazione/Application	Rif. Orig./Orig. Ref.	Immagine/Image
<b>LUK635351009</b>	Kit tutto originale LUK composto da - Kit all LUK original consists of: - Meccanismo/Clutch Ref. 135 0279 10 - Disco Avanzamento a 7 pale/Clutch Disc 7 pairs of pads 335 0321 10	<b>SAME</b>	SAME 170, SAME GALAXY 170, SAME HERCULES 160, SAME JAGUAR 100 EXPORT, SAME JAGUAR 95 EXPORT, SAME LASER 100 - 110 - 130, SAME LASER 150 - 165 - 170, SAME LASER 85 TRANSPORTER, SAME LASER 90, SAME LEOPARD 90 T, SAME TAURUS 100 E, SAME TRIDENT 130	0.014.0175.4, 0.014.0176.3	
<b>LUK500059730</b>	Cuscinetto reggispinta completo 111 x 65 x 30 mm / Bearing + carrier assy 111 x 65 x 30 mm		BUFFALO 120, BUFFALO 130, LASER 110, LASER 130, LASER 150, LASER 165	0.264.6533.3/20	
<b>LUK500084630</b>	Cuscinetto reggispinta 90,60 x 55 x 22 mm / Thrust Bearing 90,60 x 55 x 22 mm		SAME ANTARES 100, SAME ANTARES 110 - 130, SAME ANTARES II 110, SAME ANTARES II 130, SAME EXPLORER 100 SPECIAL LP, SAME EXPLORER 80 SPECIAL, SAME EXPLORER 80 SPECIAL LP, SAME EXPLORER 90 SPECIAL, SAME EXPLORER 90 SPECIAL LP, SAME EXPLORER II 80, SAME EXPLORER II 80 LP, SAME EXPLORER II 80 TOP, SAME EXPLORER II 90 T, SAME GALAXY 170, SAME LASER 170, SAME ROW CROP 90, SAME SILVER 100.4, SAME SILVER 100.6, SAME SILVER 115 - 130, SAME SILVER 80, SAME SILVER 90	2.2999.207.0, 2.2999.510.0	









**KIT FRIZIONE LUK 625300710**

KIT EMBRAYAGE LUK 625300710

KIT CLUTCH LUK 625300710

KIT KUPPLUNG LUK 625300710

KIT EMBRAGUE LUK 625300710

Art./Ref.	Note/Notes	Brand	Applicazione/Application	Rif. Orig./Orig. Ref.	Immagine/Image
<b>LUK625300710</b>	Kit tutto originale LUK composto da - Kit all LUK original consists of: - Meccanismo/Clutch Ref. 225 0055 10 - Disco Pto/Disc Pto 323 0556 10 - Cuscinetto/Bearing Ref. 500 0459 00 - Cuscinetto/Bearing Ref. 500 0673 00 - Cuscinetto/Bearing Ref. 410 0026 00	SAME	SAME ARGON 55 CLASSIC, SAME ARGON F 55 CLASSIC	0.008.4743.4, 0.008.4744.3, 0.011.9063.3, 0.012.2564.4, 2.2021.018.0, 2.2999.153.0/10, 2.2999.478.0	    
<b>LUK500045900</b>	Cuscinetto reggispinta 90 x 50 x 21,60 mm / Thrust Bearing 90 x 50 x 21,60 mm		ARGON 50/55/55F/60/70/75F/70CL, ASTER 60/70,FRUTTETO 60/75, FRUTTETO 60II/75II/85II, KRYPTON V70/V80, ROCK 55/60/70	2.299.153.0/1, 2.2999.153.0, 2.2999.153.0/1, 2.2999.153.0/10, 2.2999.478.0	
<b>LUK500067300</b>	Cuscinetto pto 100 x 65 x 18 mm / Pto Bearing 100 x 65 x 18 mm		SAME ARGON 55 CLASSIC, SAME ARGON F 55 CLASSIC	2.2021.017.0	



**KIT FRIZIONE LUK 631107510**

KIT EMBRAYAGE LUK 631107510

KIT CLUTCH LUK 631107510

KIT KUPPLUNG LUK 631107510

KIT EMBRAGUE LUK 631107510

Art./Ref.	Note/Notes	Brand	Applicazione/Application	Rif. Orig./Orig. Ref.	Immagine/Image
<b>LUK631107510</b>	Kit tutto originale LUK composto da - Kit all LUK original consists of: - Meccanismo/Clutch Ref. 131 0229 10 - Disco avanzamento/Disc clutch 331 0184 10 - Cuscinetto/Bearing Ref. 500 0076 11	SAME	SAME ANTARES 100, SAME DORADO 60 - 70, SAME EXPLORER 70 C ERGOMATIC, SAME EXPLORER 70 SPECIAL, SAME EXPLORER 90 C TURBO, SAME EXPLORER II 60 SPECIAL, SAME EXPLORER II 70 SPECIAL, SAME EXPLORER II 70 SPECIAL BA, SAME EXPLORER II 70 TOP, SAME EXPLORER II 80 SPECIAL BA, SAME EXPLORER II 80 TOP, SAME EXPLORER II 90 T, SAME GOLDEN 60 - 65 COMPATTO, SAME GOLDEN 75 - 85 COMPATTO, SAME ROW CROP 90	0.014.9424.3, 0.014.9433.3, 2.2999.475.0	  

**MECCANISMO + DISCO AVANZAMENTO ORIGINALE LUK RIF. 633312310 - 633312300**

MECANISME + DISQUE AVANCEMENT ORIGINAL LUK 633312310 - 633312300

COVER ASSEMBLY + ORIGINAL MAIN DRIVE LUK REF. 633312310 - 633312300

GETRIEBE + VORSCHLEIBE LUK 633312310 - 633312300

MECANISMO + DISCO DE AVANCE ORIGINAL LUK REF. 633312310 - 633312300

Art./Ref.	Note/Notes	Brand	Applicazione/Application	Rif. Orig./Orig. Ref.	Immagine/Image
<b>LUK633312310</b>	Kit tutto originale LUK composto da - Kit all LUK original consists of: - Meccanismo/Clutch Ref. 133 0279 10 - Disco avanzamento a 6 pale/Disc clutch 6 pairs of pads 333 0116 10 - Cuscinetto/Bearing Ref. 500 0846 30		SAME ANTARES 100, SAME EXPLORER 100 SPECIAL LP, SAME EXPLORER 80 SPECIAL, SAME EXPLORER 80 SPECIAL LP, SAME EXPLORER 90 SPECIAL, SAME EXPLORER 90 SPECIAL LP, SAME EXPLORER II 80, SAME EXPLORER II 80 LP, SAME EXPLORER II 80 SPECIAL LP, SAME EXPLORER II 80 TOP, SAME EXPLORER II 90 T, SAME ROW CROP 90, SAME SILVER 100.4 - 100.6, SAME SILVER 80 - 90	0.008.4184.3, 0.014.9423.3/10, 0.016.6105.3, 2.2999.207.0, 2.2999.510.0	
<b>LUK633312300</b>	Kit tutto originale LUK composto da - Kit all LUK original consists of: - Meccanismo/Clutch Ref. 133 0279 10 - Disco avanzamento/Disc clutch 333 0117 10 - Cuscinetto/Bearing Ref. 500 0846 30	<b>SAME</b>	SAME ANTARES 100, SAME EXPLORER 100 SPECIAL LP, SAME EXPLORER 80 SPECIAL, SAME EXPLORER 80 SPECIAL LP, SAME EXPLORER 90 SPECIAL, SAME EXPLORER 90 SPECIAL LP, SAME EXPLORER II 80, SAME EXPLORER II 80 LP, SAME EXPLORER II 80 SPECIAL LP, SAME EXPLORER II 80 TOP, SAME EXPLORER II 90 T, SAME ROW CROP 90, SAME SILVER 100.4 - 100.6, SAME SILVER 80 - 90	0.008.4184.3, 0.014.9423.3/10, 0.014.9431.3, 2.2999.207.0, 2.2999.510.0	
<b>LUK500084630</b>	Cuscinetto reggispinta 90,60 x 55 x 22 mm / Thrust Bearing 90,60 x 55 x 22 mm		SAME ANTARES 100, SAME ANTARES 110 - 130, SAME ANTARES II 110, SAME ANTARES II 130, SAME EXPLORER 100 SPECIAL LP, SAME EXPLORER 80 SPECIAL, SAME EXPLORER 80 SPECIAL LP, SAME EXPLORER 90 SPECIAL, SAME EXPLORER 90 SPECIAL LP, SAME EXPLORER II 80, SAME EXPLORER II 80 LP, SAME EXPLORER II 80 TOP, SAME EXPLORER II 90 T, SAME GALAXY 170, SAME LASER 170, SAME ROW CROP 90, SAME SILVER 100.4, SAME SILVER 100.6, SAME SILVER 115 - 130, SAME SILVER 80, SAME SILVER 90	2.2999.207.0, 2.2999.510.0	

**MECCANISMO + DISCO AVANZAMENTO ORIGINALE LUK RIF. 63353510 - 635353810**

MECANISME + DISQUE AVANCEMENT ORIGINAL LUK 635353510 - 635353810

COVER ASSEMBLY + ORIGINAL MAIN DRIVE LUK REF. 635353510 - 635353810

GETRIEBE + VORSCHLEIBE LUK 635353510 - 635353810

MECANISMO + DISCO DE AVANCE ORIGINAL LUK REF. 635353510- 635353810

Art./Ref.	Note/Notes	Brand	Applicazione/Application	Rif. Orig./Orig. Ref.	Immagine/Image
<b>LUK635353510</b>	Kit tutto originale LUK composto da - Kit all LUK original consists of: - Meccanismo/Clutch Ref. 135 0284 10 - Disco avanzamento 330 mm Z24/Disc clutch 330 mm Z24 333 0215 10 - Cuscinetto/Bearing Ref. 500 0076 11	<b>SAME</b>	SAME EXPLORER 80 SPECIAL, SAME EXPLORER 80 SPECIAL LP, SAME EXPLORER 90 SPECIAL, SAME EXPLORER 90 SPECIAL LP, SAME EXPLORER II 80, SAME EXPLORER II 80 LP, SAME EXPLORER II 90 T, SAME ROW CROP 100.6, SAME SILVER 100.4 - 100.6, SAME SILVER 80 - 90	0.015.6381.3, 0.015.6386.3, 2.2999.475.0	
<b>LUK635353810</b>	Kit tutto originale LUK composto da - Kit all LUK original consists of: - Meccanismo/Clutch Ref. 135 0284 10 - Disco avanzamento 350 mm Z24/Disc clutch 350 mm Z24 335 0337 10 - Cuscinetto/Bearing Ref. 500 0076 11	<b>SAME</b>	SAME EXPLORER 80 SPECIAL, SAME EXPLORER 80 SPECIAL LP, SAME EXPLORER 90 SPECIAL, SAME EXPLORER 90 SPECIAL LP, SAME EXPLORER II 80, SAME EXPLORER II 80 LP, SAME EXPLORER II 90 T, SAME ROW CROP 100.6, SAME SILVER 100.4 - 100.6, SAME SILVER 80 - 90	0.015.6328.3, 0.015.6386.3, 2.2999.475.0	

**MECCANISMO + DISCO AVANZAMENTO ORIGINALE LUK RIF. 635353910**

MECANISME + DISQUE AVANCEMENT ORIGINAL LUK 635353910

COVER ASSEMBLY + ORIGINAL MAIN DRIVE LUK REF. 635353910

GETRIEBE + VORSCHLEIBE LUK 635353910

MECANISMO + DISCO DE AVANCE ORIGINAL LUK REF. 635353910

Art./Ref.	Note/Notes	Brand	Applicazione/Application	Rif. Orig./Orig. Ref.	Immagine/Image
<b>LUK635353910</b>	Kit tutto originale LUK composto da - Kit all LUK original consists of: - Meccanismo/Clutch Ref. 135 0284 10 - Disco avanzamento 350 mm Z21/Disc clutch 350 mm Z21 335 0338 10 - Cuscinetto/Bearing Ref. 500 0076 11	<b>SAME</b>	SAME ANTARES II 110, SAME SILVER 110	0.007.7930.3/10, 0.015.6386.3, 2.2999.475.0	

**KIT FRIZIONE LUK ORIGINALE RIF. MECCANISMO 0.014.9017.3**

KIT EMBRAYAGE LUK ORIGINAL REF. 0.014.9017.3

KIT CLUTCH ORIGINAL LUK REF. 0.014.9017.3

KIT KUPPLUNG LUK REF. 0.014.9017.3

KIT EMBRAGUE LUK ORIGINAL REF. 0.014.9017.3

Art./Ref.	Note/Notes	Brand	Applicazione/Application	Rif. Orig./Orig. Ref.	Immagine/Image
LUK131031210	Meccanismo Frizione 12" - Luk originale/ Clutch 12" - Original Luk	SAME	SAME DORADO 3 70 - 80 - 90, SAME DORADO F 100 - F 70, SAME DORADO F 75 - F 90, SAME EXPLORER 3 85 - 85 T, SAME EXPLORER 3 85 TB, SAME FRUTTETO 3 100 - 3 100 S, SAME FRUTTETO 3 100 V, SAME FRUTTETO 3 110 - 3 110 S, SAME FRUTTETO 3 110 V, SAME FRUTTETO 3 80 - 3 80 S, SAME FRUTTETO 3 80 V, SAME FRUTTETO 3 90 - 3 90 S, SAME FRUTTETO 3 90 V, SAME FRUTTETO 3 90.3 S, SAME FRUTTETO 3 90.3 V	0.014.9017.3	
LUK331034610	Disco avanzamento 310 mm a 6 pale Luk originale /Clutch Disc Diameter 310 mm 6 pairs of pads Original Luk		SAME DORADO 3 70 - 80 - 90, SAME DORADO F 100 - F 70, SAME DORADO F 75 - F 90, SAME EXPLORER 3 85 - 85 T, SAME EXPLORER 3 85 TB, SAME FRUTTETO 3 100 - 3 100 S, SAME FRUTTETO 3 100 V, SAME FRUTTETO 3 110 - 3 110 S, SAME FRUTTETO 3 110 V, SAME FRUTTETO 3 80 - 3 80 S, SAME FRUTTETO 3 80 V, SAME FRUTTETO 3 90 - 3 90 S, SAME FRUTTETO 3 90 V, SAME FRUTTETO 3 90.3 S, SAME FRUTTETO 3 90.3 V	0.014.9016.3	

**KIT FRIZIONE LUK ORIGINALE RIF. MECCANISMO 0.016.6106.3**

KIT EMBRAYAGE LUK ORIGINAL REF. 0.016.6106.3

KIT CLUTCH ORIGINAL LUK REF. 0.016.6106.3

KIT KUPPLUNG LUK REF. 0.016.6106.3

KIT EMBRAGUE LUK ORIGINAL REF. 0.016.6106.3

Art./Ref.	Note/Notes	Brand	Applicazione/Application	Rif. Orig./Orig. Ref.	Immagine/Image
LUK135028510	Meccanismo Frizione 14" - Luk originale/ Clutch 14" - Original Luk	SAME	SAME ANTARES II 110, SAME EXPLORER 75, SAME EXPLORER 80 SPECIAL, SAME EXPLORER 80 SPECIAL LP, SAME EXPLORER 85 - 85 T, SAME EXPLORER 85 TB, SAME EXPLORER 90 SPECIAL, SAME EXPLORER 90 SPECIAL LP, SAME EXPLORER 95, SAME EXPLORER 95 CLASSIC, SAME EXPLORER 95 T, SAME EXPLORER 95 TB, SAME EXPLORER II 85 SPECIAL, SAME EXPLORER II 90 T, SAME EXPLORER II 95 SPECIAL, SAME ROW CROP 100, SAME ROW CROP 100.6, SAME ROW CROP 90, SAME SILVER 100.4 - 100.6, SAME SILVER 105 - 110, SAME SILVER 80 - 85 - 90 - 95	0.016.6106.3	
LUK333011610	Disco avanzamento 330 mm a 6 pale Luk originale/Clutch Disc Diameter 330 mm 6 pairs of pads Original Luk		SAME ANTARES II 110, SAME EXPLORER 75, SAME EXPLORER 80 SPECIAL, SAME EXPLORER 80 SPECIAL LP, SAME EXPLORER 85 - 85 T, SAME EXPLORER 85 TB, SAME EXPLORER 90 SPECIAL, SAME EXPLORER 90 SPECIAL LP, SAME EXPLORER 95, SAME EXPLORER 95 CLASSIC, SAME EXPLORER 95 T, SAME EXPLORER 95 TB, SAME EXPLORER II 85 SPECIAL, SAME EXPLORER II 90 T, SAME EXPLORER II 95 SPECIAL, SAME ROW CROP 100, SAME ROW CROP 100.6, SAME ROW CROP 90, SAME SILVER 100.4 - 100.6, SAME SILVER 105 - 110, SAME SILVER 80 - 85 - 90 - 95	0.016.6105.3	

**MECCANISMO + DISCO PTO ORIGINALE LUK RIF. 628313009**

MECANISME + DISQUE PTO ORIGINAL LUK 628313009

COVER ASSEMBLY + ORIGINAL PTO DISC LUK REF.628313009

GETRIEBE + ZAPFWELLENSCHEIBE LUK 628313009

MECCANISMO + DISCO PTO ORIGINAL LUK REF. 628313009

Art./Ref.	Note/Notes	Brand	Applicazione/Application	Rif. Orig./Orig. Ref.	Immagine/Image
LUK628313009	Kit tutto originale LUK composto da - Kit all LUK original consists of: - Meccanismo/Clutch Ref. 228 0067 11 - Disco Pto/Disc Pto 328 0127 16	SAME LAMBORGHINI HURLIMANN	LAMBORGHINI R613V, SAME CORSARO 70 FRUTTETO, SAME CORSARO 70 SYNCHRO, SAME FALCON 50, SAME MINITAURUS 60 FRUTTETO, SAME MINITAURUS 60 FRUTTETO, SAME MINITAURUS 60 SYNCHRO, SAME TAURUS 60, SAME VIGNERON 60 - 70	0.194.2210.4/20, 0.194.2213.3/10	
LUK500058810	Cuscinetto reggispinta 102 x 65 x 26 mm / Thrust Bearing 102 x 65 x 26 mm		LAMBORGHINI R613V, SAME CORSARO 70 FRUTTETO, SAME CORSARO 70 SYNCHRO, SAME FALCON 50, SAME MINITAURUS 60 FRUTTETO, SAME MINITAURUS 60 FRUTTETO, SAME MINITAURUS 60 SYNCHRO, SAME TAURUS 60, SAME VIGNERON 60 - 70	2.2999.003.0	

**FRIZIONI ADATTABILI E ORIGINALI**

EMBRAYAGES ADAPTABLES ET ORIGINAUX  
ADAPTABLE AND ORIGINAL CLUTCHES  
ADAPTABLE UND ORIGINAL KUPPLUNGEN  
EMBRAGUES ADAPTABLES Y ORIGINALES



Art./Ref.	Descrizione estesa/Extended Description	Brand	Applicazione/Application	Rif. Orig./Orig. Ref.
<b>12821</b>	Meccanismo adattabile rif. orig. 5150649	<b>FIAT</b>	440, 446, 470 SPECIAL, 474, 566, 666, 766	5150649, 5158605
<b>N05117767</b>	Frizione adattabile a rif. orig. Fiat 511776			5117767
<b>NH5150921</b> <small>ORIGINALE</small>	Meccanismo originale Fiat rif. 5150921	<b>NEW HOLLAND</b>		5150921
<b>NH82008823</b> <small>ORIGINALE</small>	Frizione originale Fiat rif. 82008823			82008823
<b>29858</b>	Frizione singola Ø 330 mm adattabile a rif. orig. Ford 82011590	<b>FORD</b>		82011590
<b>21937</b>	Frizione adattabile a rif. orig. 83925716		5000,5100,5110,5190,5200,5550, 5600,5610,5700,6550,6610, 6700,6710	81817036, 83924567, 83925716, C7NN7563B, E0NN7563CA
<b>42273</b>	Frizione adattabile a rif. orig. CNH 83912979		7810, 7910, 8000, 8200, 8210, 8530, 8600, 8700, 9000, 9200, 9600, 9700	83912979, D8NN7563BA
<b>42231R</b>	Frizione adattabile a rif. orig. Ford 81805201			81805201, 960E7502
<b>42247BS</b>	Frizione adattabile a rif. orig. Ford 81815765		3055, 4000, 4100, 4400, 4500, 4600	81815765, C5NN7563U
<b>LN3559804M91</b> <small>ORIGINALE</small>	Frizione originale Landini rif. 3559804M91	<b>LANDINI</b>		3559804M91
<b>40792</b>	Frizione singola adattabile a rif. orig. Massey Ferguson 3599492M91	<b>MASSEY FERGUSON</b>	1004T, 375,396,390, 390T, 398, 399, 698, 698T, 699	1688208M91, 3599492M91
<b>40799</b>	Frizione singola adattabile a rif. orig. Massey Ferguson 3381122M2		2620, 2625, 2640, 2645, 2680, 2685, 2720, 2725, 3610, 3630, 3635, 3645, 3650, 3655, 3660, 3670	3381122M2
<b>40812</b>	Frizione doppia adattabile a rif. orig. Massey Ferguson 3620408M91		165, 168, 178, 185, 188	3620408M91, 887884M91, 887886M91
<b>40814R</b>	Frizione doppia adattabile a rif. orig. Massey Ferguson 3580944M92			3580944M92
<b>12788</b>	Frizione adattabile rif. orig. 0.264.3654.4	<b>SAME LAMBORGHINI HURLIMANN</b>	LASER 130 TURBO, LASER 150 TURBO, LASER 165 TURBO	0.264.3654.4
<b>V0.008.5531.4</b> <small>ORIGINALE</small>	Frizione completa originale Same rif. 0.008.5531.4	<b>SAME</b>		0.008.5531.4
<b>V0.015.6392.4</b> <small>ORIGINALE</small>	Frizione completa originale Same rif. 0.015.6392.4			0.015.6392.4
<b>V0.135.2410.0/1</b> <small>ORIGINALE</small>	Scatola frizione originale Same rif. 0.135.2410.0/10			0.135.2410.0/10

**DISCHI FRIZIONE ORIGINALI E ADATTABILI**

DISQUES EMBRAYAGES ORIGINAL ET ADAPTABLE

CLUTCH DISCS ORIGINAL AND ADAPTABLE

KUPPLUNGSSCHEIBEN ORIGINAL UND PASSEND ZU

DISCOS EMBRAGUE ORIGINAL Y ADAPTABLE



Art./Ref.	Descrizione estesa/ Extended Description	Tipo/Type	Brand	Applicazione/Application	Rif. Orig./Orig. Ref.	
<b>07894</b>	Disco PTO adattabile Deutz rif. orig. 4378783	Ø 310, senza amianto, n° 16 cave	<b>DEUTZ</b>	AGROPRIMA 6.16, AGROXTRA 4.47, AGROXTRA 4.57, AGROXTRA 6.07, AGROXTRA 6.17, DX 110 A, DX 120 A, DX 6.10, DX 6.30	02940102, 02940173, 02940358, 04314891, 04342203, 04378783, 04382852	
<b>15717</b>	Disco frizione centrale adattabile a rif. orig. Fiat.79040803		<b>FIAT</b>		79040803	
<b>19138</b>	Disco adattabile a rif. orig. Fiat 5158586				5158586	
<b>28176</b>	Disco adattabile a rif. orig. Fiat 5146477				5146477	
<b>14989</b>	Disco 12" cambio in sinterizzato molleggiato adattabile Fiat rif. orig. 5150922 modelli 90.90, 100.90, 110.90, 880/5, 980	12"			100.90, 110.90, 880/5, 90.90, 980	5122560, 5144011, 5150922
<b>07871</b>	Disco avanzamento adattabile Fiat rif. orig. 5143411	12"" sinterizzato			115.90, 1180, 1280, 130.90, 1380, 140.90, 1580, 1580 TURBO, 1880	5112624, 5116211, 5122099, 5143411
<b>07876</b>	Disco avanzamento adattabile Fiat rif. orig. 5128011	Ø 310, parastrappi, n° 18 cave			1580, 160.90, 180.90 DAL 1984, 1880	5128011
<b>26989</b>	Disco pto adattabile Fiat rif. orig. 5160417	Ø 310, senza amianto, n° 10 cave			880/4, 880/4 DT	5160417
<b>07868R</b>	Disco avanzamento adattabile Fiat rif. orig. 4998654				1000, 1000 DT, 850, 850 DT	4998654
<b>12937R</b>	Disco adattabile a rif. orig. Fiat 586578					586578
<b>N05160409</b>	Disco frizione adattabile rif. orig. Fiat 5160409					5160409
<b>N04996759</b>	Disco dentato adattabile a rif. orig. Fiat 4996759					4996759
<b>N0587817</b>	Spingidisco adattabile a rif. orig. Fiat 587817					587817
<b>N0563596</b>	Spingidisco adattabile a rif. orig. Fiat 563596					563596
<b>N0563586</b>	Spingidisco adattabile rif. orig. Fiat 563586					563586
<b>42487</b>	Disco d'attrito per frizione, adattabile a rif. orig. Ford 83924789			<b>FORD</b>	2810, 2910, 3230, 3430, 3910, 3930, 4110, 4130, 4610, 4630, 4830, 5030	83924789, EONNP743AA
<b>42491</b>	Disco d'attrito per frizione, adattabile a rif. orig. Ford 83917372				5640, 6640, 7740, 7840, 8240, 8000, 8200, 8530, 8600, 8630, 8340, 8700, 8730, 9000, 9200, 9600, 9700, TW 5, 10, 15, 20, 25	83917372, D1NN9743A
<b>42277</b>	Disco frizione adattabile a rif. orig. CNH 83955477	sinterizzato - 8 pale			8630, 8730, 8830	83932846, 83955477, D8NN7550BB, E7NN7550CA
<b>07882</b>	Disco avanzamento adattabile John Deere rif. orig. AL33126	Ø 327, parastrappi, senza amianto, n° 10 cave	<b>JOHN DEERE</b>		AL33126	
<b>07883</b>	Disco avanzamento adattabile John Deere rif. orig. AL68022	Ø 327, parastrappi, n° 10 cave			3050, 3350, 3640, 3650	AL68022
<b>07907</b>	Disco avanzamento adattabile Landini rif. orig. 3105364M92	Ø 330, parastrappi, n° 23 cave	<b>LANDINI</b>	12500, 13000, 14500, REX NEW TIER 2 FP CAB: 105, REX NEW TIER 2 FP CAB: 75, REX NEW TIER 2 FP CAB: 85, REX NEW TIER 2 FP CAB: 95, VISION NEW TIER 2: 105, VISION NEW TIER 2: 85, VISION NEW TIER 2: 95, VISION: 100, VISION: 80, VISION: 90	3668512	

Art./Ref.	Descrizione estesa/ Extended Description	Tipo/Type	Brand	Applicazione/Application	Rif. Orig./Orig. Ref.
<b>41066</b>	Disco frizione adattabile a rif. orig. Massey Ferguson 1618239M4		<b>MASSEY FERGUSON</b>		1618239M4
<b>41067</b>	Disco adattabile a rif. Orig. Massey Ferguson 1618238M3				1618238M3
<b>29861</b>	Disco frizione adattabile a rif. orig. Fiat 5176449	11"	<b>NEW HOLLAND</b>	TN65F, TN70F	5176449
<b>12770</b>	Disco avanzamento adattabile a rif. orig. 216.2450.3	Ø310 senza amianto, n 20 cave	<b>SAME</b>	C704, C784, LEOPARD C	0.216.2450.3
<b>12771</b>	Disco PTO adattabile a rif. orig. 195.2222.3	Ø310 senza amianto, n 14 cave	<b>LAMBORGHINI HURLIMANN</b>	LEOPARD C, R955, R955DT	0.195.2222.3
<b>16019</b>	Disco frizione adattabile a rif. orig. Same 0.008.5596.3		<b>SAME</b>		0.008.5596.3
<b>V0.212.2359.3/1</b>	Disco frizione originale Same rif. 0.212.2359.3/10				0.212.2359.3/10
<b>V0.014.1111.3</b>	Disco frizione in ceramica 12" originale Same rif. 0.014.1111.3				0.014.1111.3
<b>V0.009.6924.3/2</b>	Disco frizione 12" originale Same rif. 0.009.6924.3/20				0.009.6924.3/20
<b>V0.007.7929.3/2</b>	Disco frizione 14" in organico originale Same rif. 0.007.7929.3/20				0.007.7929.3/20
<b>V0.014.9428.3</b>	Disco frizione originale Same rif. 0.014.9428.3				0.014.9428.3
<b>V0.008.4749.3</b>	Disco frizione cambio originale Same rif. 0.008.4749.3				0.008.4749.3
<b>V0.422.2222.3</b>	Disco frizione 10" originale Same rif. 0.422.2222.3				0.422.2222.3
<b>V0.010.7535.3</b>	Disco frizione 13" cerametallico originale Same rif. 0.010.7535.3				0.010.7535.3
<b>V0.009.9769.3</b>	Disco frizione 13" originale Same rif. 0.009.9769.3				0.009.9769.3

**KIT CENTRATURA FRIZIONE - LUK**

KIT ALIGNEMENT D'EMBRAYAGE - LUK  
 CLUTCH ALIGNMENT KIT - LUK  
 KIT ZUR KUPPLUNGS AUSRICHT. - LUK  
 KIT ALINEACIÓN ACOPLAM. - LUK



Art./Ref.	Descrizione estesa/Extended Description	Note/Notes
<b>LUK400043410</b>	Kit per un veloce e accurato centraggio di frizione e disco che riduce al minimo il rischio di danni durante il montaggio - Ideale per i trattori CNH, John Deere, Landini, Massey Ferguson, SDF e tanti altri.	32 collegamenti mozzo: da 14mm a 45mm - 11 perni di centraggio: 12mm, 14mm, 15mm, 16mm, 17mm, 20mm, 22mm, 25mm, 30mm, 36mm, 40mm/ 32 hub dollies: 14mm through to 45mm - 11 spigots: 12mm, 14mm, 15mm, 16mm, 17mm, 20mm, 22mm, 25mm, 30mm, 36mm, 40mm

**KIT RICAMBI FRIZIONE ADATTABILI MASSEY FERGUSON**

KIT DE RECHANGE EMBRAYAGE ADAPTABLE MASSEY FERGUSON  
 SPARE PARTS KIT ADAPTABLE MASSEY FERGUSON  
 KUPPLUNG ERSATZTEILE KIT PASSEND ZU MASSEY FERGUSON  
 KIT DE RECAMBIOS ADAPTABLE MASSEY FERGUSON

Art./Ref.	Note/Notes	Tipo/Type	Brand	Applicazione/Application	Rif. Orig./Orig. Ref.
<b>40819</b>	kit levette/ kit toggle lever	305 mm	<b>MASSEY FERGUSON</b>	135,148,155,158,165,168,185,, 188,230,240,250,265,275,285,, 290,340,342,350,352,355,360,, 362,365,375,390,550,565,575,, 590,675,690,298,390T,398,399, 595,698,698T,699	1810857M92
<b>40841</b>	kit piatto/kit pressure plate	280 mm		35, 65, 135, 165, 175, 178,, 35,135, 35,65,135,165,175,178,765, 765	1860161M91
<b>40842</b>	kit piatto/kit pressure plate	305 mm		135,148,155,158,165,168,185, 188,230,240,250,265,175,290,, 340,342,350,352,355,360,362,, 365,375,390,550,565,575,590,, 675,690	

# 1.7.15 Frizioni sterzo

Steering Clutches



## Ricambi & accessori per macchine agricole

SPARE PARTS & ACCESSORIES FOR AGRICULTURAL MACHINE

Tutti gli articoli della presente sezione, prodotti da AMA SPA e/o da terzi per conto di AMA, sono adattabili ("non originali") alle marche indicate ai sensi di quanto previsto dal REG. CE n. 1400/2002. I diritti sui marchi citati appartengono ai legittimi proprietari ed il loro uso ha l'esclusiva finalità di consentire all'utilizzatore la comparazione dei diversi prodotti. All items of this section, manufactured by AMA SPA and/or any third party on behalf of AMA, are adaptable ("non-original") to the brands listed under the provisions of the REG. CE n. 1400/2002. The rights on the trademarks belong to their respective owners and their usage is only aimed to allow the user to compare different products.



**TAMBURI FRIZIONI STERZO ADATTABILI**
*BARILLER EMBRAYAGE DE DIRECTION ADAPTABLE*
*DRUM STEERING CLUTCHES ADAPTABLE*
*KUPPLUNGSTROMMEL PASSEND ZU*
*TAMBOR DE LA FRICCION DE DIRECCION ADAPTABLE*

Art./Ref.	Brand	Applicazione/Application	Rif. Orig./Orig. Ref.	Immagine/Image
10543	FIAT	55.46, 55.46 DT, 60.46, 60.46 DT, 640, 65.46, 65.46 DT	4980824	
14355		355C, 411C, 455C, 505C, 555C, 605C	4992428, 566522	
14773		450, 480S, 500S, 540S	596206	
14779		665C, 765C	5119536	
14779	NEW HOLLAND	TK 60.65, TK 60.65M, TK 60.65V, TK 60.75, TK 60.75M, TK 70.65, TK 70.65M, TK 70.75, TK 70.75M, TK 80.65, TK 80.75	5119536	
15335		TK 55-65F, TK 55-65M, TK 55-65V, TK 55-75F, TK 55-75M, TK 55-75V, TK 55-85F, TK 55-85M, TK 55-85V, TK 60-65, TK 60-65M, TK 60-65V, TK 60-75V, TK 60-85F, TK 60-85V, TK65F, TK65V, TK70FA, TK70VA, TK75F, TK75FA, TK75V, TK75VA	5119531, 5148334	
71416	LANDINI	C4830, CF4830, CF5030	3310554M1	
71420		C7830, C8860	3310562M1	
LN3535009M2			3535009M2	
VO.216.5710.0/1	SAME		0.216.5710.0/10	

**MANICOTTI FRIZIONE COMPLETI**

MANCHON D'EMBAYAGE  
COMPLETE CLUTCHE SLEEVES  
KUPPLUNGSHULSE  
MANGUITO D'EMBRAGUE

Art./Ref.	Brand	Applicazione/Application	Rif. Orig./Orig. Ref.
<b>05764</b>	FIAT	355C, 411C, 455C, 505C, 605C	4974241, 574317, 599733
<b>35408</b>		355C SUPER, 455C SUPER, 505C SUPER, 555C SUPER, 605C SUPER	4984282
<b>18927</b>		640, 65.46	5102147
<b>27908</b>		115.90, 130.90, 140.90, 160.90, 1180, 1280, 1380, 1580, 1580T, 180.90, 1880, 115-90	5103270
<b>15164</b>		90.0, 100.90, 110.90	5105431
<b>27922</b>			5159163
<b>29911</b>			44016044
<b>35000</b>			5177201
<b>35001</b>			5177204
<b>14020R</b>			4975281, 594560, 79008064, 79034436
<b>N05106564</b>			5106564
<b>N044016693</b>			44016693



**ANELLI DENTATI STERZO ADATTABILI FIAT**

BAGUES DE DIRECTION CRANTEE ADAPTABLE FIAT  
STEERING TOOTHED RINGS ADAPTABLE FIAT  
LENKKUPPLUNGEN PASSEND ZU FIAT  
EMBRAGUES DE DIRECCION ADAPTABLE FIAT

Art./Ref.	Note/Notes	Brand	Applicazione/Application	Rif. Orig./Orig. Ref.
<b>10579</b>	219,2 X 152 X 6	FIAT	25C, 311C	5163644, 568911
<b>10577</b>	271 X 201 X 5		655C, 805C, FL6, OM 50	5104903, 5161597, 5170228, 568400
<b>10577</b>	271 X 201 X 5	LANDINI	C7800, C7830, C8860	3300186M1



**DISCHI FRIZIONE STERZO ADATTABILI**

DISQUE EMBRAYAGE DE DIRECTION ADAPTABLE  
DISC OF STEERING CLUTCHES ADAPTABLE  
KUPPLUNGSSCHEIBE PASSEND ZU  
DISCO FRICCION DE DIRECCION ADAPTABLE

Art./Ref.	Note/Notes	Brand	Applicazione/Application	Rif. Orig./Orig. Ref.	Immagine/Image
<b>10573</b>	Impasto normale colore rosso / Normal compound red colour 239x180x4,8	FIAT	312C, 355C, 455C, 465C, 505C, 605C, 665C, 765C, FL4	4981417, 4981418, 5104806, 5104894, 5109934, 5109935, 5109936, 5109937, 5109938, 5174442, 566520	
<b>37815</b>	Impasto rinforzato ad alta resistenza /Strength compound with high resistance 239x180x4,8	LANDINI	C4500, C4830, C5500, C5830, C6500, C6830, CF4830, CF5030, CF5830, CF6030, CF6060, CF6830, TREKKER:CF55, TREKKER:CF60, TREKKER:CF70	1423483M1	
<b>37815</b>	Impasto rinforzato ad alta resistenza /Strength compound with high resistance 239x180x4,8	NEW HOLLAND	SERIE 55.65 - 60.65 - 80.65, TK65F, TK65V, TK70FA, TK70VA, TK75F, TK75FA, TK75V, TK75VA	5197641	

# 1.7.16 Frizioni per piccoli motori

Small Engine Clutches

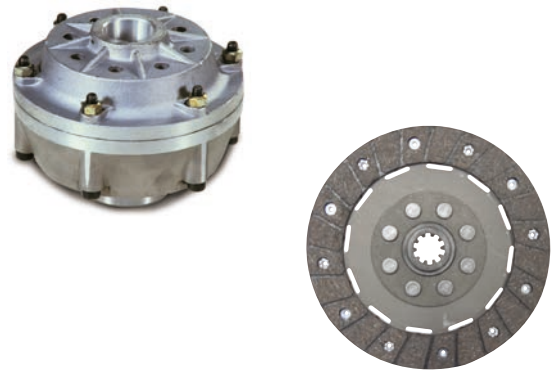

**Ricambi & accessori per macchine agricole**

**SPARE PARTS & ACCESSORIES FOR AGRICULTURAL MACHINE**

Tutti gli articoli della presente sezione, prodotti da AMA SPA e/o da terzi per conto di AMA, sono adattabili ("non originali") alle marche indicate ai sensi di quanto previsto dal REG. CE n. 1400/2002. I diritti sui marchi citati appartengono ai legittimi proprietari ed il loro uso ha l'esclusiva finalità di consentire all'utilizzatore la comparazione dei diversi prodotti. All items of this section, manufactured by AMA SPA and/or any third party on behalf of AMA, are adaptable ("non-original") to the brands listed under the provisions of the REG. CE n. 1400/2002. The rights on the trademarks belong to their respective owners and their usage is only aimed to allow the user to compare different products.

**FRIZIONI PICCOLI MOTORI ADATTABILI**

EMBRAYAGES PETIT MOTEURS ADAPTABLE

SMALL ENGINE CLUTCHES ADAPTABLE

KUPPLUNGEN KLEINE MOTOREN PASSEND ZU

EMBRAGUES MOTORES PEQUENOS ADAPTABLE



Art./Ref.	Dimensioni/Sizes	Note/Notes	Brand	Applicazione/Application	Rif. Orig./Orig. Ref
<b>05664</b>	Ø 138 x 25 mm	Frizione monodisco con molle a diaframma /Single disc clutch with diaphragm spring	<b>BARBIERI</b>	MOTOZAPPA ZEBRA FB 210	
<b>05660</b>	Ø 104 x 97 mm	Frizione conica. Albero 22,5 mm, Conicita' 1:5, 8 cave/Tapered clutch, Shaft 22.5 mm, Taper 1:5 12x15EV, 8 splines	<b>BCS</b>	MOTOCOLTIVATORI SERIE 600/700, MOTOCOLTIVATORI SERIE 715/735, MOTOFALCIATRICI SERIE 600/700, MOTOFALCIATRICI SERIE 715/735	592.48106
<b>05660</b>	Ø 104 x 97 mm	Frizione conica. Albero 22,5 mm, Conicita' 1:5, 8 cave/Tapered clutch, Shaft 22.5 mm, Taper 1:5 12x15EV, 8 splines	<b>BENASSI</b>	MOTOZAPPA RL 300 (FRIZ.LUNGA)	
<b>05662</b>	Ø 104 x 66 mm	Frizione conica, Albero 22,5 mm, Conicita' 1:5, 8 cave/Tapered clutch, shaft 22.5 mm, Taper 1:5 12x15EV, 8 splines		MOTOZAPPA RL300 ( FRIZ.CORTA )	
<b>05660</b>	Ø 104 x 97 mm	Frizione conica. Albero 22,5 mm, Conicita' 1:5, 8 cave/Tapered clutch, Shaft 22.5 mm, Taper 1:5 12x15EV, 8 splines	<b>BERTOLINI</b>	MOTOCOLT 307 ( FRIZ. LUNGA )	
<b>05664</b>	Ø 138 x 25 mm	Frizione monodisco con molle a diaframma /Single disc clutch with diaphragm spring		MOTOCOLT 305	81.9220.00
<b>09512</b>	Ø 104 x 84,5 mm	Frizione conica, Albero 22,5 mm, Conicita' 1:5, 8 cave/Tapered clutch, Shaft 22.5 mm, Taper 1:5 12x15EV, 8 splines		MOTOCOLT 307-406 ( FRIZ.CORTA), MOTOFALCIATRICE 134 - 140	120003
<b>09514</b>	Ø 104 x 87,5 mm	Frizione conica vite lunga, Albero 22,5 mm, Conicita' 1:5, 8 cave/Tapered clutch long screw, Shaft 22.5 mm, Taper 1:5 12x15EV, 8 splines		MOTOCOLT 406 (MOT ALN330)	
<b>05664</b>	Ø 138 x 25 mm	Frizione monodisco con molle a diaframma /Single disc clutch with diaphragm spring	<b>BRUMITAL</b>	MOTOZAPPA	
<b>05664</b>	Ø 138 x 25 mm	Frizione monodisco con molle a diaframma /Single disc clutch with diaphragm spring	<b>CARRARO</b>	CARRARINO SERIE MINI E SPECIAL	5.107.502
<b>05664</b>	Ø 138 x 25 mm	Frizione monodisco con molle a diaframma /Single disc clutch with diaphragm spring	<b>EUROGARDEN</b>	MOTOCOLTIVATORI TITANO	
<b>05660</b>	Ø 104 x 97 mm	Frizione conica. Albero 22,5 mm, Conicita' 1:5, 8 cave/Tapered clutch, Shaft 22.5 mm, Taper 1:5 12x15EV, 8 splines	<b>EUROSYSTEMS</b>	MOTOZAPPA (BENZINA)	
<b>05660</b>	Ø 104 x 97 mm	Frizione conica. Albero 22,5 mm, Conicita' 1:5, 8 cave/Tapered clutch, Shaft 22.5 mm, Taper 1:5 12x15EV, 8 splines	<b>FERRARI</b>	MOTOCOLT 71 (2A SERIE)	
<b>05664</b>	Ø 138 x 25 mm	Frizione monodisco con molle a diaframma /Single disc clutch with diaphragm spring		MOTOCOLT 71 (1A SERIE)	81.9220.00
<b>09545</b>	Ø 215	Frizione monodisco a molle elicoidali/Single plate clutch with coil springs		TRATTORINI MT65 (2)	7.15.208

Art./Ref.	Dimensioni/Sizes	Note/Notes	Brand	Applicazione/Application	Rif. Orig./Orig. Ref
09533	Piatto Ø 187 mm	Frizione monodisco a molle elicoidali/Single plate clutch with coil springs	FIAT	18 LA PICCOLA, 200, 211R, 213R, 215R, 215R (FINO A TELAIO 313566), 220C, 241R, 251D	4023341
09545	Ø 215	Frizione monodisco a molle elicoidali/Single plate clutch with coil springs		215R (DAL TELAIO 313667), 25 CI - CP - CSI (TIPO A PED), 25 R, 25 RS, 250, 255 C, 300, 311, 312, 315 N, 331 R	558106, 595731
05662	Ø 104 x 66 mm	Frizione conica, Albero 22,5 mm, Conicita' 1:5, 8 cave/Tapered clutch, shaft 22.5 mm, Taper 1:5 12x15EV, 8 splines	FORT	MOTAZAPPA TIGROTTO-EL TIGRE	
05664	Ø 138 x 25 mm	Frizione monodisco con molle a diaframma /Single disc clutch with diaphragm spring		MOTAZAPPA-MOTOFALCIATRICE	
05660	Ø 104 x 97 mm	Frizione conica. Albero 22,5 mm, Conicita' 1:5, 8 cave/Tapered clutch, Shaft 22.5 mm, Taper 1:5 12x15EV, 8 splines	GRILLO	MOTOCOLTIVATORI GRILLINO 1100, MOTO-COLTIVATORI GRILLINO 127, MOTOFALCIATRICI BL / BC	
05664	Ø 138 x 25 mm	Frizione monodisco con molle a diaframma /Single disc clutch with diaphragm spring	IMER	MOTAZAPPA SERIE 115	
05660	Ø 104 x 97 mm	Frizione conica. Albero 22,5 mm, Conicita' 1:5, 8 cave/Tapered clutch, Shaft 22.5 mm, Taper 1:5 12x15EV, 8 splines	MAB	MOTOCOLTIVATORI PANDA 135 10HP	592431394
09533	Piatto Ø 187 mm	Frizione monodisco a molle elicoidali/Single plate clutch with coil springs	NIBBI	TRATTORINO G119-219-520-521	
05664	Ø 138 x 25 mm	Frizione monodisco con molle a diaframma /Single disc clutch with diaphragm spring	NIBBI DECIMO	MOTOCOLTIVATORI MAJOR	
05662	Ø 104 x 66 mm	Frizione conica, Albero 22,5 mm, Conicita' 1:5, 8 cave/Tapered clutch, shaft 22.5 mm, Taper 1:5 12x15EV, 8 splines	PASQUALI	MOTAZAPPA 938-939-952-953	939 183 0
09545	Ø 215	Frizione monodisco a molle elicoidali/Frizione monodisco a molle elicoidali/Single plate clutch with coil springs	RAPID	MOTOFALCIATRICE ALLTRAC	
05664	Ø 138 x 25 mm	Frizione monodisco con molle a diaframma /Single disc clutch with diaphragm spring	VALPADANA	MOTOCOLT VMC 12-160	109081

**DISCHI PER FRIZIONI MOTORI SINO A 14HP ADATTABILI**

DISQUES D'EMBRAYAGES POUR MOTEUR JUSQU'A 14HP ADAPTABLE

CLUTCH DISCS FOR ENGINE UP TO 14HP ADAPTABLE

KUPPLUNGSSCHEIBE FÜR MOTOREN BIS 14HP PASSEND ZU

DISCOS DE EMBRAGUE PARA MOTORES HASTA 14HP ADAPTABLE



Art./Ref.	Dimensioni/Sizes	Note/Notes	Brand	Applicazione/Application	Rif. Orig./Orig. Ref.
<b>02364</b>	Ø 140 x 96mm, 17x15 EV, 20 cave/splines	Disco frizione rigido in ferodo/ Rigid clutch disc lining	<b>ADRIATICA</b>	MINIMEC SUPERMEC 14 HP	
<b>02368</b>	181x127mm, 23x20 EV, 20 cave/splines	Disco frizione rigido in ferodo/ Rigid clutch disc lining		MASTERMEC L2 - R2 - S2 - L30, MOTOAGRICOLA MAJORMEC 1, MOTOAGRICOLA MAJORMEC 2	
<b>02365</b>	160x110mm, 19x15,5x3, 10 cave/splines	Disco frizione rigido in ferodo/ Rigid clutch disc lining	<b>BARBIERI</b>	MOTOCOLTIVATORI FB SERIE 1400, MOTOCOLTIVATORI LEOPARD, MOTOCOLTIVATORI PIONEER	
<b>02366</b>	184x127mm, 19x15,5x3, 10 cave/splines	Disco frizione rigido in ferodo/ Rigid clutch disc lining		TRATTORINI FB SERIE 1800, TRATTORINI PANTHER - DELFINO	
<b>02379</b>	110x60mm, 15x12EV, 8 cave/splines	Disco frizione rigido in ferodo/ Rigid clutch disc lining		MOTOZAPPE ZEBRA FB SERIE 210	
<b>05665</b>	110x75mm, 15x12EV, 8 cave/splines	Disco rigido sinterizzato/ Sintered hard drive		MOTOCOLT GIAGUARO SERIE 1600	
<b>01539</b>	178x133mm, 25x20EV, 15 cave/splines	Disco frizione rigido in ferodo/ Rigid clutch disc lining	<b>BCS</b>	MOTOFALCIATRICE 622	590024260
<b>02363</b>	155x114mm, 16x13x3,5, 6 cave/splines	Disco frizione rigido in ferodo/ Rigid clutch disc lining		MOTOCOLTIVATORI 705	581010091
<b>02372</b>	178x133mm, 23x18x3, 10 cave/splines	Disco frizione rigido in ferodo/ Rigid clutch disc lining	<b>BEDOGNI</b>	MOTOFALCIATRICE OLIMPIA	12231
<b>02379</b>	110x60mm, 15x12EV, 8 cave/splines	Disco frizione rigido in ferodo/ Rigid clutch disc lining		MOTOCOLTIVATORE COLIBRI', MOTOFALCIATRICE	60053
<b>05665</b>	110x75mm, 15x12EV, 8 cave/splines	Disco rigido sinterizzato/ Sintered hard drive		MOTOCOLTIVATORI COLIBRI'	
<b>02379</b>	110x60mm, 15x12EV, 8 cave/splines	Disco frizione rigido in ferodo/ Rigid clutch disc lining	<b>BENASSI</b>	MOTOCOLTIVATORI 421, MOTOZAPPA RL 95 - 100 - 634L	
<b>02364</b>	Ø 140 x 96mm, 17x15 EV, 20 cave/splines	Disco frizione rigido in ferodo/ Rigid clutch disc lining	<b>BERTOLINI</b>	MOTOCOLTIVATORI 315	81.9033.00
<b>02368</b>	181x127mm, 23x20 EV, 20 cave/splines	Disco frizione rigido in ferodo/ Rigid clutch disc lining		421 DIESEL 1C, 424 - 431 - 432 - DIESEL 2C, 428 - 450, 450 DIESEL 3 CILINDRI	81.9134.20
<b>02371</b>	184x127mm, 22x18x3,5, 10 cave/splines	Disco frizione rigido in ferodo/ Rigid clutch disc lining		MOTOCOLTIVATORI BM 12, TRATTORINI 412T	81.9006.00
<b>02379</b>	110x60mm, 15x12EV, 8 cave/splines	Disco frizione rigido in ferodo/ Rigid clutch disc lining		MOTOCOLTIVATORI 305	81.9221.00
<b>08093</b>	145x102mm, 26x21x3, 10 cave/splines	Disco frizione rigido in ferodo/ Rigid clutch disc lining		MOTOFALCIATRICI BRF 58	81.9030.00
<b>08097</b>	178x134mm, 26x21x3, 10 cave/splines	Disco frizione rigido in ferodo/ Rigid clutch disc lining		MOTOFALCIAT 124 - 125 - 126	81.9036.00
<b>05665</b>	110x75mm, 15x12EV, 8 cave/splines	Disco rigido sinterizzato/ Sintered hard drive	<b>BRUMITAL</b>	MOTOZAPPE, MOTOZAPPE CON FRIZIONE DA 110MM	
<b>02368</b>	181x127mm, 23x20 EV, 20 cave/splines	Disco frizione rigido in ferodo/ Rigid clutch disc lining	<b>CARON</b>	TRANSPORTER MC 20	
<b>09558</b>	160x110mm, 17x15EV, 20 cave/splines	Disco frizione rigido in ferodo/ Rigid clutch disc lining		TRANSPORTER C 12	

Art./Ref.	Dimensioni/Sizes	Note/Notes	Brand	Applicazione/Application	Rif. Orig./Orig. Ref.
02379	110x60mm, 15x12EV, 8 cave/splines	Disco frizione rigido in ferodo/ Rigid clutch disc lining	CARRARO	CARRARINO SERIE MINI E SPECIAL, CARRARINO SERIE SUPER	5.108.501
09558	160x110mm, 17x15EV, 20 cave/splines	Disco frizione rigido in ferodo/ Rigid clutch disc lining	CARRARO ANTONIO	TIGRE 2800	5.108.514
02379	110x60mm, 15x12EV, 8 cave/splines	Disco frizione rigido in ferodo/ Rigid clutch disc lining	DIESSE	MT2 ERCOLE ORSETTO ERCOLINO	
02368	181x127mm, 23x20 EV, 20 cave/ splines	Disco frizione rigido in ferodo/ Rigid clutch disc lining	DISALCAR	TRANSPORTER 20H	
05665	110x75mm, 15x12EV, 8 cave/splines	Disco rigido sinterizzato/ Sintered hard drive	EUROGARDEN	MOTOCOLTIVATORI TITANO	
02364	Ø 140 x 96mm, 17x15 EV, 20 cave/ splines	Disco frizione rigido in ferodo/ Rigid clutch disc lining	FERRARI	MOTOCOLTIVATORI 72 (1, MOTOCOLTI- VATORI MC 68	81.9033.00
02368	181x127mm, 23x20 EV, 20 cave/ splines	Disco frizione rigido in ferodo/ Rigid clutch disc lining		MOTOCOLTIVATORI 74, TRATTORINI 74- 75 1, TRATTORINO 75 2, TRATTORINO 76, TRATTORINO 94 - 95	81.9134.20
02379	110x60mm, 15x12EV, 8 cave/splines	Disco frizione rigido in ferodo/ Rigid clutch disc lining		MOTOCOLTIVATORI 71 (1	81.9221.00
09469	140x96mm, 17x14x4, 6 cave/splines	Disco frizione rigido in ferodo/ Rigid clutch disc lining		MOTOCOLTIVATORI MC 64	
09558	160x110mm, 17x15EV, 20 cave/splines	Disco frizione rigido in ferodo/ Rigid clutch disc lining		MOTOCOLTIVATORI 72 2, TRATTORINI 72T	81.9304.20
02367	216x152mm, 22x18x3,5, 10 cave/ splines	Disco frizione rigido in ferodo/ Rigid clutch disc lining	FIAT	215R (DAL TELAIO 313667), 25CSI (TIPO A PEDALE), 25R - 25RS, 311-312-315N-331R	560446, 594614, 594916, 595725
09554	215x152, 25x22EV, 10 cave/splines	Disco frizione rigido in ferodo/ Rigid clutch disc lining		250 - 255C - 300	4968661, 5134615, 5160429
02365	160x110mm, 19x15,5x3, 10 cave/ splines	Disco frizione rigido in ferodo/ Rigid clutch disc lining	FORT	CENTAURO	
02379	110x60mm, 15x12EV, 8 cave/splines	Disco frizione rigido in ferodo/ Rigid clutch disc lining		MOTOCOLTIVATORI TIGROTTO, MOTO- ZAPPA MOTOFALCIATRICE	
02365	160x110mm, 19x15,5x3, 10 cave/ splines	Disco frizione rigido in ferodo/ Rigid clutch disc lining	GOLDONI	MOTOCOLTIVATORI SPECIAL, MOTOCOL- TIVATORI SPECIAL LUX, MOTOCOLTI- VATORI SUPER SPECIAL	0007474
02366	184x127mm, 19x15,5x3, 10 cave/ splines	Disco frizione rigido in ferodo/ Rigid clutch disc lining		MOTOCOLTIVATORI EXPORT, MOTOCOL- TIVATORI SERIE 500 700, TRATTORINI 926 - 933 RS/DT	6300045
02367	216x152mm, 22x18x3,5, 10 cave/ splines	Disco frizione rigido in ferodo/ Rigid clutch disc lining		MOTOAGR TRANSPOR EURO 40RS/ SN, MOTOAGRICOLE TRANSCAR 38-40, MOTOAGRICOLE TRANSCAR 55, MOTOA- GRICOLE TRANSPORTER 336, TRATTORI SERIE 1050 - 1055, TRATTORINI 1038 - 1045R - 834, TRATTORINI 236 - 238 - 240, TRATTORINI 945 RS/DT	6300038
02371	184x127mm, 22x18x3,5, 10 cave/ splines	Disco frizione rigido in ferodo/ Rigid clutch disc lining		TRATTORINI 926 - 933 RS/DT	6300048
05665	110x75mm, 15x12EV, 8 cave/splines	Disco frizione rigido in ferodo/ Rigid clutch disc lining		MOTOCOLT JOLLY PROFESSIONAL, MOTOCOLT SPECIAL LUX, MOTOCOLTI- VATORI JOLLY JUNIOR, MOTOCOLTIVATORI JOLLY SUPER	6300063
02363	155x114mm, 16x13x3,5, 6 cave/ splines	Disco frizione rigido in ferodo/ Rigid clutch disc lining	GRILLO	MOTOCOLTIVATORI GRILLO 2	7052
02379	110x60mm, 15x12EV, 8 cave/splines	Disco frizione rigido in ferodo/ Rigid clutch disc lining	IMER	MOTUZAPPA SERIE 115	
02367	216x152mm, 22x18x3,5, 10 cave/ splines	Disco frizione rigido in ferodo/ Rigid clutch disc lining	ITMA	4RM SIRIO - G 215 AC2	651814

Art./Ref.	Dimensioni/Sizes	Note/Notes	Brand	Applicazione/Application	Rif. Orig./Orig. Ref.
<b>02370</b>	155x114mm, 17x14x4, 6 cave/splines	Disco frizione rigido in ferodo/Rigid clutch disc lining	<b>MAB</b>	MOTOCOLTIVATORE TALPA, TRATTORINO TALPA 4RM	
<b>02379</b>	110x60mm, 15x12EV, 8 cave/splines	Disco frizione rigido in ferodo/Rigid clutch disc lining	<b>NIBBI</b>	MOTOCOLTIVATORI MAJOR	
<b>05665</b>	110x75mm, 15x12EV, 8 cave/splines	Disco frizione rigido in ferodo/Rigid clutch disc lining		MOTOCOLTIVATORI	
<b>02380</b>	184x127mm, 25x21EV, 15 cave/splines	Disco frizione rigido in ferodo/Rigid clutch disc lining	<b>NIBBI BRUNO-YABE</b>	TRATTORINI G119 - G219, TRATTORINI G520 - G521	NB4453
<b>02373</b>	160x108mm, 22x19x3,5, 10 cave/splines	Disco frizione rigido in ferodo/Rigid clutch disc lining	<b>PASQUALI</b>	MOTOCOLTIVATORI 921 - 922, MOTOCOLTIVATORI 923 - 924, MOTOCOLTIVATORI 933, MOTOCOLTIVATORI 934 - 917	424.002.0
<b>09457</b>	180x124mm, 29,5x23x4, 10 cave/splines	Disco frizione rigido in ferodo/Rigid clutch disc lining		MOTOCOLTIVATORE 945	945.215.0
<b>02367</b>	216x152mm, 22x18x3,5, 10 cave/splines	Disco frizione rigido in ferodo/Rigid clutch disc lining	<b>PGS</b>	TRATTORINI ROMA 500 - R55, TRATTORINI TRANSPORTER 450	02922
<b>02371</b>	184x127mm, 22x18x3,5, 10 cave/splines	Disco frizione rigido in ferodo/Rigid clutch disc lining		DUMPER 2096 - 3078, MOTOCOLTIVATORI ATILA SUPER, MOTOCOLTIVATORI F13-F14-F16, MOTOCOLTIVATORI L15, TRATTORINI ROMA 38	
<b>02371</b>	184x127mm, 22x18x3,5, 10 cave/splines	Disco frizione rigido in ferodo/Rigid clutch disc lining	<b>POLENTES</b>	TRATTORINO PIERRE	
<b>02365</b>	160x110mm, 19x15,5x3, 10 cave/splines	Disco frizione rigido in ferodo/Rigid clutch disc lining	<b>RANDI</b>	MOTOCOLTIVATORE 2500 - 2500 SU, MOTOCOLTIVATORE 3000-3500-4000, MOTOCOLTIVATORE 6000 JUNIOR	
<b>02366</b>	184x127mm, 19x15,5x3, 10 cave/splines	Disco frizione rigido in ferodo/Rigid clutch disc lining		MOTOCOLTIVATORI 3600Q, TRATTORINI R421 - R424	
<b>02379</b>	110x60mm, 15x12EV, 8 cave/splines	Disco frizione rigido in ferodo/Rigid clutch disc lining	<b>SEP</b>	MOTOFALCIATRICE 150 - 200	210.962
<b>02367</b>	216x152mm, 22x18x3,5, 10 cave/splines	Disco frizione rigido in ferodo/Rigid clutch disc lining	<b>VALPADANA</b>	TRATTORINI 4RM 350 - 4RM 450	104951
<b>02370</b>	155x114mm, 17x14x4, 6 cave/splines	Disco frizione rigido in ferodo/Rigid clutch disc lining		MOTOCOLTIVATORI VMC 14	104337
<b>02371</b>	184x127mm, 22x18x3,5, 10 cave/splines	Disco frizione rigido in ferodo/Rigid clutch disc lining		MOTOCOLTIVATORI PADANO D12-D14, MOTOCOLTIVATORI PADANO VMC 18, TRATTORINI 4RM20	102770
<b>02379</b>	110x60mm, 15x12EV, 8 cave/splines	Disco frizione rigido in ferodo/Rigid clutch disc lining		MOTOCOLTIVATORI VMC160 - VMC12	108783



# 1.7.17 Dischi freno

Brake discs

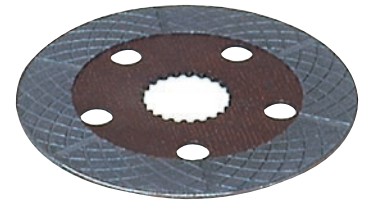

## Ricambi & accessori per macchine agricole

SPARE PARTS & ACCESSORIES FOR AGRICULTURAL MACHINE

Tutti gli articoli della presente sezione, prodotti da AMA SPA e/o da terzi per conto di AMA, sono adattabili ("non originali") alle marche indicate ai sensi di quanto previsto dal REG. CE n. 1400/2002. I diritti sui marchi citati appartengono ai legittimi proprietari ed il loro uso ha l'esclusiva finalità di consentire all'utilizzatore la comparazione dei diversi prodotti. All items of this section, manufactured by AMA SPA and/or any third party on behalf of AMA, are adaptable ("non-original") to the brands listed under the provisions of the REG. CE n. 1400/2002. The rights on the trademarks belong to their respective owners and their usage is only aimed to allow the user to compare different products.

**DISCHI FRENO ADATTABILI**

DISQUES FREIN ADAPTABLE  
BRAKE-DISCS ADAPTABLE TO  
BREMSSCHEIBEN PASSEND ZU  
PLATOS FRENO ADAPTABLE

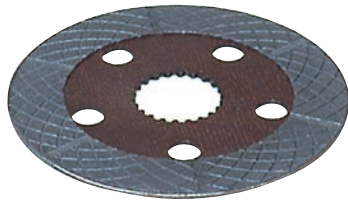

Art./Ref.	Note/Notes	Brand	Applicazione/Application	Rif. Orig./Orig. Ref.
<b>15330</b>	Disco adattabile a rif. orig. Fiat 5159148	<b>FIAT</b>	55.85 FMV-60.85 FMV-62.85 M, 72.85 M -TK65 FV-TK65 FMV, TK76 M-TK85 M-TK95M	5112063, 5159148
<b>10580</b>			45.66, 45.66DT, 45.76, 50.66, 50.66DT, 55.66, 55.76, 55.86, 56.66S, 60.66, 60.76, 60.86, 65.66, 70.66, 70.76, 70.86, 72.86, 80.66, 80.76, 82.86	5159830
<b>10581</b>			45.66-45.66 DT, 45.66S-45.66S DT, 45.76 V, 50.66-50.66 DT, 50.66S-50.66S DT, 50.86 V, 50.86 V DT, 50.86S V, 50.86S V DT, 55.46-55.46 DT, 55.56-55.56 DT, 55.66 DT LP, 55.66 LP, 55.66-55.66 DT, 55.66S-55.66S DT, 55.76 F, 55.76 F DT, 55.76 V, 55.76 V DT, 55.86 F, 55.86 F DT, 55.86 V, 55.86 V DT, 55.86S V, 55.86S V DT, 56.66S-56.66S DT, 60.46-60.46 DT, 60.56-60.56 DT, 60.66 F DT, 60.66 LP, 60.66 LP DT, 60.66-60.66 DT, 60.66F, 60.66S-60.66S DT, 60.76 F, 60.76F DT, 60.86 F, 60.86 F DT, 60.86 V, 60.86 V DT, 60.86S V, 60.86S V DT, 62.86 F, 62.86 F DT, 65.46-65.46 DT, 65.56-65.56 DT, 65.66-65.66 DT, 65.66S-65.66S DT, 70.56-70.56 DT, 70.66 F, 70.66 V, 70.66-70.66 DT, 70.66S-70.66S DT, 70.76 F, 70.76 F DT, 70.76 LP, 70.76 LP DT, 70.76 V, 70.86 V, 70.86 V DT, 70.86S V, 70.86S V DT, 72.86 F, 72.86 F DT, 72.86 LP, 72.86 LP DT, 80.66 F DT, 80.66-80.66 DT, 80.66F DT, 80.66S-80.66S DT, 80.76 F, 80.76 F DT, 82.86 F, 82.86 F DT, 82.86 LP	5119327
<b>12930</b>			100.90, 100.90 DT, 110.90, 110.90 DT, 680, 780, 880, 90.90, 90.90 DT	4993584, 4993585
<b>12931</b>			55.88, 55.88 DT, 55.90, 55.90 DT, 60.88, 60.88 DT, 60.90, 60.90 DT, 60.93, 60.93 DT, 60.94, 60.94 DT, 65.88, 65.88 DT, 65.90, 65.90 DT, 65.93, 65.93 DT, 65.94, 65.94 DT, 680, 70.88, 70.88 DT, 70.90, 70.90 DT, 72.93, 72.93 DT, 72.94, 72.94 DT, 780, 80.88, 80.88 DT, 80.90, 80.90 DT, 82.93, 82.93 DT, 82.94, 82.94 DT, 85.90, 85.90 DT, 88.93, 88.93 DT, 88.94, 88.94 DT, 880	4997208, 4999494, 4999495
<b>12933</b>			850 DTS-1000 DTS-1300 DTS	44011292, 8995071
<b>12934</b>			850 DTS-1000 DTS-1300 DTS	44011293, 8995072
<b>15591</b>			615, 715, 650, 750	44092218, 5160738, 9023259
<b>26162</b>			115.90-115.90 DT, 130.90-130.90 DT, 140.90-140.90 DT, 160.90-160.90 DT, 180.90-180.90 DT	5146315
<b>42266</b>			F100-F100 DT, F110-F110 DT, F115-F115 DT, F120-F120 DT, F130-F130 DT, F140-F140 DT	5146036
<b>16805</b>				44983301
<b>NO5111276M</b>				5111276M
<b>NO4995966M</b>				4995966M
<b>10580</b>			<b>FORD</b>	3010, 3435, 3830, 3935, 4010, 4030, 4135, 4230, 4430
<b>10581</b>		3010S-4010S-5010S, 3435, 3935, 4135, 3830-4030-4230-4430		5119327
<b>12931</b>		4635, 4835, 5635, 6635, 7635		4997208
<b>22219</b>	Ø 9" - 228 mm >05.88	5000, 5110, 5600, 5610, 5900, 6410, 6600, 6610, 6700, 6710, 6810, 7000, 7600, 7610, 7700, 7710, 7810, 7910, 8210		81818854
<b>26162</b>		8430, 8630, 8830		5146315
<b>42266</b>		8160, 8260, 8360, 8560		5146036
<b>42521</b>	Freno a secco principale/ Main dry brake disc	MAJOR, SUPER MAJOR, POWER MAJOR		81717001
<b>42528</b>		2810, 2910, 3910, 4110, 4610, 3230, 3430, 3930, 4130, 4630, 4830, 5030, 3930H		83983209, CSNN2A097B
<b>16020</b>	Disco freno posteriore / Rear brake disc	<b>HURLIMANN</b>	H362, H372, H466, H468, H476, H476.4, H478, H478.4, H488T, H496T, H5116, H6130, H6136, H6160, H6170T, HCLUB 468.4, HELITE 4105, 6115, 6135, HXB ELITE 6115, 6135, HXF 361, 476, 481, 491, MASTER 6165, 6190, MASTER HP/SX 1002, 1350, 1500, PRESTIGE 468, 478, 488, PRESTIGE H468, H478, H488, XT 908, 909, 910.4, 910.6, 911, XT 913	154.5459.0/10
<b>26692</b>	Disco freno posteriore/ Rear brake disc		H362, H372, HXF 361, 476, 481, 491	008.4661.0
<b>26694</b>	Disco freno posteriore/ Rear brake disc		HXE305	008.5267.2
<b>26699</b>			ELITE 4105, H476, H478.4, H488T, HT 908, 909, PRESTIGE 478, 488	009.7067.2

Art./Ref.	Note/Notes	Brand	Applicazione/Application	Rif. Orig./Orig. Ref.
16020	Disco freno posteriore / Rear brake disc	LAMBORGHINI	1106, 1306, 1506, 1706, 674.70N, 674.5, 774.80N, 774.5, R674, 674.70, 674.70GP, R774, 774.80, 874.90GP, R965.100, RACING 150, 165, 190, RACING HI.PER	154.5459.0/10
26692	Disco freno posteriore/ Rear brake disc		700, 600	008.4661.0
26694	Disco freno posteriore/ Rear brake disc		CRONO 554.50	008.5267.2
26699			FORMULA 105P, PREMIUM 774.5, R874.90T, PREMIUM 850, 950, R774, 774.80, PREMIUM 874.90GP, 774.80N	009.7067.2
10580		LANDINI	ATLAS:100, ATLAS:75, ATLAS:80, ATLAS:85, ATLAS:90, GLOBUS: 75, GLOBUS:50, GLOBUS:55, GLOBUS:60, GLOBUS:65, GLOBUS:70, GLOBUS:80	3537089M1
41072	Disco bronzo - Brake disc 13 Cave - Spline	MASSEY FERGUSON	3070 (>B082009), 3075 (>B082009), 3080 (>B082009), 3085, 3090, 3095, 6150, 6160, 6170, 6180, 6190	3617652M91
41087	Disco freno - Brake disc 14 Cave - Spline 350 x 70 x 7,7 mm		2620, 2625, 2640, 2645, 2680, 2685, 3610, 3630, 3680, 6180, 3115 (<B126020), 3120 (<B126020), 3120T (<B126020), 3125 (<B126020), 3140 (<B126020), 3635 (<B126025), 3645 (<B126025), 3655 (<B126025), 3660 (<B126025), 3670 (<B126020), 8110, 8120, 8130, 8140, 8150	3386897M92
41088	Disco freno - Brake disc 13 Cave - Spline 355 x 64 x 7,7 mm		3070 (<B126033), 3080, 3090, 3085 (<B126033), 3095 (<B126033)	3386896M92
43029R				3617653M91
10580		NEW HOLLAND	TD60, TD65, TD70, TD75, TD80, TD85, TD95	5159830
10581			665TL, L620-L630, T4.55-T4.65-T4.75, TD3.50, TD4020F-TD4030F-TD4040F, TD5010, TD5020, TD503, TD5040, TD5050, TD55D-TD60D-TD65D-TD70D-TD75D, TD60-TD70-TD80-TD90-TD95, TD65B, TD65F-TD75F-TD85F, TD80D-TD90D-TD95D, TD85D-TD85F, TK80.66 DT, TT55-TT65-TT65D-TT75	5119327
12931			L60, L65, L70, L75, L85, L95, TL100, TL55F, TL65, TL65A, TL65F, TL70, TL75F, TL80, TL90	4997208
42266			M115, M135, M160, TM110, TM115, TM120, TM125, TM130, TM135, TM140, TM150, TM155, TM165, TM175, TM180, TM190, TM7010, TM7020, TM7030, TM7040	5146036
NH5161748	ORIGINALE			5161748
16020	Disco freno posteriore / Rear brake disc	SAME	ANTARES 100, 110, 130, ANTARES II 110, 130, ASTER 70, CENTAURO 70EX, 70SP, CENTURION 75EX, 750SP, EXPLORER 65.70, 65.70SP, EXPLORER 75.80, 75.80SP, 80SP, EXPLORER 90SP, 90SP/LP, 90T, EXPLORER II 70, 70SP, 80.90	154.5459.0/10
26692	Disco freno posteriore / Rear brake disc		ASTER 60, 70, FRUTTETO II 60, 75, 85, ROW CROP 80, SATURNO 80, 80 SINCR0, TAURUS 60, VIGNERON 60, 70	008.4661.0
26694	Disco freno posteriore / Rear brake disc		ARGON 50	008.5267.2
26699			ANTARES 100, 110, 130, EXPLORER 75.80, 75.80SP, EXPLORER 80.90II, 80.80SP/LP, EXPLORER 90.90SP/LP, 90T, SILVER 80.90	009.7067.2
V0.011.0587.2	ORIGINALE			0.011.0587.2
V0.008.5267.2	ORIGINALE			0.008.5267.2
V0.009.7066.2	ORIGINALE			0.009.7066.2

# 1.7.18 Bandelle freno

Brake flaps



## Ricambi & accessori per macchine agricole

SPARE PARTS & ACCESSORIES FOR AGRICULTURAL MACHINE

Tutti gli articoli della presente sezione, prodotti da AMA SPA e/o da terzi per conto di AMA, sono adattabili ("non originali") alle marche indicate ai sensi di quanto previsto dal REG. CE n. 1400/2002. I diritti sui marchi citati appartengono ai legittimi proprietari ed il loro uso ha l'esclusiva finalità di consentire all'utilizzatore la comparazione dei diversi prodotti. All items of this section, manufactured by AMA SPA and/or any third party on behalf of AMA, are adaptable ("non-original") to the brands listed under the provisions of the REG. CE n. 1400/2002. The rights on the trademarks belong to their respective owners and their usage is only aimed to allow the user to compare different products.

**BANDELLE FRENO ADATTABILI**
*SANGLES DE FREIN ADAPTABLE*
*BRAKE BANDS ADAPTABLE*
*BREMSBÄNDEN PASSEND ZU*
*CINCHO DE FRENO ADAPTABLE*

Art./Ref.	Dimensioni/Sizes	Tipo/Type	Modello/Model	Brand	Applicazione/Application	Rif. Orig./Orig. Ref.
<b>08152</b>	Ø int.227, h.56 - occhio Ø est.25, Ø int.14	Impasto	Incollata	<b>AGRIFULL</b>	55, 55DT, 55.60, 65, 65DT	
<b>26705</b>	Ø int.261, h.50 - occhio Ø est.22, Ø int.14	Tessuto	Rivettata		C60, C70	4965138, 4996577
<b>85548</b>	Ø int.261, h.50 - occhio Ø est.22, Ø int.14	Impasto	Incollata		60C, 70C, 70C SPECIAL	4965138, 4996577, 4996580
<b>91015</b>	Ø int.261, h.50 - occhio Ø est.25, Ø int.14	Tessuto	Rivettata		80.50 C	
<b>08154</b>	Ø int.261, h.50 - occhio Ø est.25, Ø int.14	Impasto	Incollata		55CV-CF, 70C SPECIAL, 80.50C	5155112, 5161640, 5162002
<b>10564</b>	210x50x6,0 - 7 fori	Tessuto	Forato		60C, 70C, 70C SPECIAL, 80.50C	
<b>91016</b>	Ø int.261, h.60 - occhio Ø est.25, Ø int.14	Tessuto	Rivettata		80.76C, 60C, 70C, 80C, 80C, 80.46C, 80.56C, 80.66C	
<b>91017</b>	Ø int.261, h.60 - occhio Ø est.25, Ø int.14	Impasto	Incollata		80.76C, 60C, 70C, 80C, 80C, 80.46C, 80.56C, 80.66C	5161638
<b>08155</b>	Ø int.261, h.65 - occhio Ø est.25, Ø int.14	Impasto	Incollata		60C, 60CL, 70C, 70CL, 80C, 80.46C, 80.56C, 80.66C, 80.76C	5164940
<b>91018</b>	Ø int.261, h.65 - occhio Ø est.25, Ø int.14	Tessuto	Rivettata		80.76C, 60C, 70C, 80C, 80C, 80.46C, 80.56C, 80.66C	
<b>91040</b>	210x60x6,0 - 7 fori	Tessuto	Forato		80.76C, 60C, 70C, 80C, 80C, 80.46C, 80.56C, 80.66C	
<b>91019</b>	Ø int.274, h.90 - occhio Ø est.25, Ø int.14	Tessuto	Rivettata		<b>CARRARO</b>	6300/655
<b>91041</b>	203x90x6,0 - 12 fori	Tessuto	Forato	6300/655		101183
<b>26705</b>	Ø int.261, h.50 - occhio Ø est.22, Ø int.14	Tessuto	Rivettata	450C, 450CL, 455C, 505C, 555C, 655C, 3500C, 4500C		86393
<b>85548</b>	Ø int.261, h.50 - occhio Ø est.22, Ø int.14	Impasto	Incollata	3500C, 4500C, 6300C, 450C, 450CL, 455C, 505C, 555C		83693
<b>10564</b>	210x50x6,0 - 7 fori	Tessuto	Forato	3500C, 4500C, 6300C, 450C, 450CL, 455C, 505C, 555C		
<b>91020</b>	Ø int.241, h.50	Tessuto	Rivettata	50.5, 620,5 (L-M-N-S-V)		660188
<b>91042</b>	210x50x7,0 - 7 fori	Tessuto	Forato	50.5, 620.5 (L-M-N-S-V)		650988
<b>91021</b>	Ø int.157, h.38 - occhio Ø est.17, Ø int.10	Tessuto	Rivettato	<b>FIAT</b>	200R, 211R, 215R, 221R, 231R, 241R, 220	5163621
<b>91022</b>	Ø int.157, h.38 - occhio Ø est.17, Ø int.10	Impasto	Incollata		200R, 211R, 215R, 221R, 231R, 241R, 220	
<b>91043</b>	192x38x5,0 - 7 fori	Tessuto	Forato		200R, 211R, 215R, 221R, 231R, 241R, 220	559594
<b>91023</b>	Ø int.167, h.38 - occhio Ø est.17, Ø int.10	Tessuto	Rivettata		250, 300, 300DT, 350, 350N, 350S, 350NS, 420, 420DT	
<b>08156</b>	Ø int.167, h.38 - occhio Ø est.17, Ø int.10	Impasto	Incollata		250, 250, 300, 300DT, 350, 350N, 30, 40, 300, 350, 420, 350S, 350NS, 420, 420DT	4966601, 4967626, 4973446, 4977668, 4989321, 4989332, 4996426, 4996427, 4996601, 4996602, 5161240, 597873

Art./Ref.	Dimensioni/Sizes	Tipo/Type	Modello/Model	Brand	Applicazione/Application	Rif. Orig./Orig. Ref.
91044	204x38x5,0 - 7 fori	Tessuto	Forato	FIAT	250, 300, 300DT, 350, 350N, 350S, 350NS, 420, 420DT	597871, 597872
91024	Ø int.212, h.50 - occhio Ø est.22, Ø int.14	Tessuto	Rivettata		311R, 312, 315, 331R, 411R-T, 418, 431R	582691
14867	Ø int.212, h.50 - occhio Ø est.22, Ø int.14	Impasto	Incollata		311R, 312, 315, 331R, 411R-T, 418, 431R	5161239
15321	171x50x6,0 - 7 fori	Tessuto	Forato		311R, 312, 315, 331R, 411R-T, 418, 431R	562286
91025	Ø int.227, h.50 - occhio Ø est.22, Ø int.14	Tessuto	Rivettata		450 (DAL 04/80), 450DT (DAL 04/80), 480, 480S, 480 VIGNETO, 480.80, 480.80DT, 480.80 VIGNETO, 500, 500DT, 540, 540DT, 550, 550DT, 600, 600DT, 640, 640DT	4954030, 4963008
91026	Ø int.227, h.50 - occhio Ø est.22, Ø int.14	Impasto	Incollata		450 (DAL 04/80), 450DT (DAL 04/80), 480, 480S, 480 VIGNETO, 480.80, 480.80DT, 480.80 VIGNETO, 500, 500DT, 540, 540DT, 550, 550DT, 600, 600DT, 640, 640DT	4980314, 4996432, 5107956
15389	183x50x6,0 - 7 fori	Tessuto	Forato		450 (DAL 04/80), 450DT (DAL 04/80), 480, 480S, 480 VIGNETO, 480.80, 480.80DT, 480.80 VIGNETO, 500, 500DT, 540, 540DT, 550, 550DT, 600, 600DT, 640, 640DT	596209
91027	Ø int.227, h.56 - occhio Ø est.22, Ø int.14	Tessuto	Rivettata		450 (DAL 04/80), 450DT (DAL 04/80), 480, 480S, 480 VIGNETO, 480.80, 480.80DT, 480.80 VIGNETO, 500, 500DT, 540, 540DT, 640, 640DT	
91028	Ø int.227, h.56 - occhio Ø est.22, Ø int.14	Impasto	Incollata		450 (DAL 04/80), 450DT (DAL 04/80), 480, 480S, 480 VIGNETO, 480.80, 480.80DT, 480.80 VIGNETO, 500, 500DT, 540, 540DT, 640, 640DT	5107958
91045	183x56x6,0 - 7 fori	Tessuto	Forato		450 (DAL 04/80), 450DT (DAL 04/80), 480, 480S, 480 VIGNETO, 480.80, 480.80DT, 480.80 VIGNETO, 500, 500DT, 540, 540DT, 640, 640DT	
17744	Ø int.227, h.50 - occhio Ø est.25, Ø int.14	Impasto	Incollata		440, 440DT, 440 VIGNETO, 450, 450DT, 480S, 480.8, 480.8DT, 480.8 VIGNETO, 550, 550DT, 600, 600DT	4954030, 4954120, 4963008, 4963274, 4965026, 4965029, 4973967, 4975221, 4980110, 4980111, 4980314, 4980315, 4996429, 4996430, 4996432, 4996433, 5102203, 5107956, 5112676, 5160713, 596207
93309	Ø int.227, h.50 - occhio Ø est.25, Ø int.14		Tessuto Incollato			
08152	Ø int.227, h.56 - occhio Ø est.25, Ø int.14	Impasto	Incollata		450, 450DT, 480S, 480.8, 480.8DT, 480.8V, 500, 500DT, 500S, 540, 540DT, 540S, 640, 640DT, 446, 446DT, 55.46DT, 55.46SUPER, 60.46DT, 65.46DT, 65.46	4996436, 5160714
91029	Ø int.241, h.50 - occhio Ø est.22, Ø int.16	Tessuto	Rivettata		25C, 25CL, 25CF, 25CS	44981752
26710	194x50x6,0 - 7 fori	Tessuto	Forato		25C, 25CL, 25CF, 25CS	536464
26705	Ø int.261, h.50 - occhio Ø est.22, Ø int.14	Tessuto	Rivettata		311C, 332C, 351C, 352C, 400C, 411C, 411CL, 451C, 455C SUPER, 455C, 505C, 505C SUPER, 555C, 605C, 605C SUPER	4965138, 4996577, 4996578, 593873
85548	Ø int.261, h.50 - occhio Ø est.22, Ø int.14	Impasto	Incollata		311C, 332C, 351C, 352C, 355C, 400C, 411C, 411CL, 451C, 455C, 455C SUPER, 505C, 505C SUPER	4965138, 4996577
91030	Ø int.261, h.56 - occhio Ø est.22, Ø int.14	Tessuto	Rivettata	555C, 605C, 605C SUPER, FL4 C, FL4 C IDROVERT, FL4 D IDROVERT, FL4 D M, FL55		
91031	Ø int.261, h.56 - occhio Ø est.22, Ø int.14	Impasto	Incollata	555C, 605C, 605C SUPER, FL4 C, FL4 C IDROVERT, FL4 D IDROVERT, FL4 D M, FL55		

Art./Ref.	Dimensioni/Sizes	Tipo/Type	Modello/Model	Brand	Applicazione/Application	Rif. Orig./Orig. Ref.
<b>91015</b>	Ø int.261, h.50 - occhio Ø est.25, Ø int.14	Tessuto	Rivettata	<b>FIAT</b>	355C, 400C, 411C, 411CL, 451C, 455C, 455C SUPER, 505C, 505C SUPER, 55.65 FRUTTETO, 55.65 MONTAGNA, 55.75 VIGNETO, 55.75 FRUTTETO, 55.75 MONTAGNA, 55.75 VIGNETO	
<b>08154</b>	Ø int.261, h.50 - occhio Ø est.25, Ø int.14	Impasto	Incollata		335C, 400C, 411C, 411CL, 451C, 455C, 455C SUPER, 505C, 505C SUPER, 55.65 FRUTTETO, 55.65 MONTAGNA, 55.65 VIGNETO, 55.75 FRUTTETO, 55.75 MONTAGNA, 55.75 VIGNETO, 60.65 VIGNETO, 60.75 VIGNETO	47134120, 4996580, 5155112, 5161640, 5162002
<b>10564</b>	210x50x6,0 - 7 fori	Tessuto	Forato		311C, 332C, 351C, 352C, 355C, 355C, 400C, 411C, 411CL, 451C, 400C, 411C, 411CL, 451C, 455C, 455C SUPER, 505C, 505C SUPER, 455C, 455C SUPER, 505C, 505C SUPER, 55.65 FRUTTETO, 55.65 MONTAGNA, 55.65 VIGNETO, 55.75 FRUTTETO, 55.75 MONTAGNA, 55.75 VIGNETO	569604, 76028900
<b>91016</b>	Ø int.261, h.60 - occhio Ø est.25, Ø int.14	Tessuto	Rivettata		60.65 FRUTTETO, 60.65 MONTAGNA, 60.75 FRUTTETO, 60.75 MONTAGNA, 70.65, 70.65 MONTAGNA, 70.75, 70.75 MONTAGNA, 80.65, 80.75	
<b>91017</b>	Ø int.261, h.60 - occhio Ø est.25, Ø int.14	Impasto	Incollata		60.65 FRUTTETO, 60.65 MONTAGNA, 60.75 FRUTTETO, 60.75 MONTAGNA, 70.65, 70.65 MONTAGNA, 70.75, 70.75 MONTAGNA, 80.65, 80.75	5123188, 5161638
<b>08155</b>	Ø int.261, h.65 - occhio Ø est.25, Ø int.14	Impasto	Incollata		60.65 FRUTTETO, 60.65 MONTAGNA, 60.75 FRUTTETO, 60.75 MONTAGNA, 70.65, 70.65 MONTAGNA, 70.75, 70.75 MONTAGNA, 80.65, 80.75	5164940
<b>91018</b>	Ø int.261, h.65 - occhio Ø est.25, Ø int.14	Tessuto	Rivettata		60.65 FRUTTETO, 60.65 MONTAGNA, 60.75 FRUTTETO, 60.75 MONTAGNA, 70.65, 70.65 MONTAGNA, 70.75, 70.75 MONTAGNA, 80.65, 80.75	
<b>91040</b>	210x60x6,0 - 7 fori	Tessuto	Forato		60.65 FRUTTETO, 60.65 MONTAGNA, 60.75 FRUTTETO, 60.75 MONTAGNA, 70.65, 70.65 MONTAGNA, 70.75, 70.75 MONTAGNA, 80.65, 80.75	
<b>10560</b>	Ø int.261, h.56 - occhio Ø est.25, Ø int.14	Tessuto	Rivettata		FL4 C, FL4 C IDROVERT, FL4 D IDROVERT, FL4 D M, FL55	4992432, 4992433, 4996583, 4996584, 76019960, 76028859, 76037913, 79020415, 79020416
<b>08158</b>	Ø int.261, h.56 - occhio Ø est.25, Ø int.14	Impasto	Incollata		FL4 C, FL4 C IDROVERT, FL4 D IDROVERT, FL4 D M, FL55, FL4C, FL4C IDROVERT, FL4D IDROVERT, FL4 LM	4992432, 4992433, 4996583, 4996584, 76019960, 76028859, 76037913, 79020415, 79020416
<b>91046</b>	210x56x6,0 - 7 fori	Tessuto	Forato		555C, 605C, 605C SUPER, FL4 C, FL4 C IDROVERT, FL4 D IDROVERT, FL4 D M, FL55	
<b>91032</b>	Ø int.309, h.92	Tessuto	Rivettata		100.55, 85.55, 855C, 95.55, 955C	
<b>91047</b>	122x92x6,5 - 6 fori	Tessuto	Forato		100.55, 85.55, 855C, 95.55, 955C	
<b>16435</b>	118x90x6,0 - 6 fori	Tessuto	Forato		FL6, 655C, 805C	
<b>15709</b>	Ø int.343, h.92	Tessuto	Seminastro inferiore - Rivettata		80C, 90C, 100C, 120C, 1355C, FA100, FA150, FL8, FL8 C, 70C	76029182
<b>15710</b>	Ø int.343, h.92	Tessuto	Seminastro superiore - Rivettato		80C, 90C, 100C, 120C, 1355C, FA100, FA150, FL8, FL8 C, 70C	76028871
<b>10565</b>	234x92x6,5 - 6 fori	Tessuto	Forato			76028870
<b>91035</b>	Ø int.341, h.90	Bagno d'olio	Rivettata		FL10 B, FL10 C, FL12, FL14 B, FL14 C, FL14 D, FD175	79004392, 79004393, 84146193
<b>91048</b>	171x90x6,5 - 10 fori	Tessuto	Forato		FL10 B, FL10 C, FL12, FL14 B, FL14 C, FL14 D, FD175	4970722, 84146194
<b>91049</b>	171x90x6,0 - 10 fori	Tessuto	Forato		FL10 B, FL10 C, FL12, FL14 B, FL14 C, FL14 D, FD175	76054807

Art./Ref.	Dimensioni/Sizes	Tipo/Type	Modello/Model	Brand	Applicazione/Application	Rif. Orig./Orig. Ref.
91050	212x90x6,5 - 10 fori	Tessuto	Forato	FIAT	10, 14, FD14, FD14 E, FD145, FD175, FL145, FL175, FL10, FL14, FA200, FP40, PL40, FD175	13852540, 13879740, 76029177, 76032297, 76040320, 76047410, 76048102, 79011420, 84146194
91051	153x120x8,0 - 10 fori	Tessuto	Forato		FD20, FL20, FP60	
14988						5108128, 5161662
N076028870						76028870
12075	Ø int.261 - h.50	Tessuto	Rivettata	LANDINI	C4500, C4830, C5500, C5830, C6500, C6830, CF4830, CF5030, CF5830, CF6030, CF6060, CF6830	1824761M91
10564	210x50x6,0 - 7 fori	Tessuto	Forato		C14000, C4500, C4830 F, C5000, C5500, C5830 F, C6000, C6030F, C6500, C6830 F, CL5000 SPECIAL, CL6000, TL6 C	1423488M1, 3308991M91
12076	Ø int.294, h.60 - occhio Ø est.25, Ø int.14	Tessuto	Rivettato		C7800, C7830	3300299M93
91052	118x60x6,0 - 5 fori	Tessuto	Forato		C7800, C7830	3300302M2, 3309388M1
91038	Ø int.261, h.60	Tessuto	Rivettata		C7800, C7830	3308992M91
91040	210x60x6,0 - 7 fori	Tessuto	Forato		C7800, C7830	3549084M1
91037	Ø int.241, h.50	Tessuto	Rivettata		C230 S, C340	400.5005.5
26710	194x50x6,0 - 7 fori	Tessuto	Forato	C230 S, C340	431.5412.0	
26707	Ø int.241, h.60	Tessuto	Rivettato	C483 C, C483 S, C503, C553, C554 COMPACT, C583, C603, C653, C664 COMPACT, C683	424.5411.4	
26851	188x60x6,0 - 7 fori	Tessuto	Forato	C484 C, C483 S, C503, C553, C554 COMPACT, C583, C603, C653, C664 COMPACT, C683	424.5412.0	
26703	Ø int.261, h.50	Tessuto	Rivettato	C483 L, C483, C503, C553 S, C553, C583, C603, C653	433.5411.4	
10564	210x50x6,0 - 7 fori	Tessuto	Forato	C483 L, C483, C503, C553 S, C483C-C483S, C503-C533-C554 COMPACT, C553, C583, C603, C653, C583-C603-C653, C664 ERGO-MATIC - C683, R230, R230 DT, R340, R340 DT	400.1815.7	
12075	Ø int.261 - h.50	Tessuto	Rivettata	MASSEY FERGUSON	MF134C, MF144C, MF154C, MF164C, MF164, MF174C, MF234CF, MF254C, MF254CF, MF274C, MF274CF	1824761M91
10564	210x50x6,0 - 7 fori	Tessuto	Forato		MF134C, MF144C, MF154C, MF164C, MF164, MF174C, MF234CF, MF254C, MF254CF, MF274C, MF274CF	1423488M1, 3308991M91
12076	Ø int.294, h.60 - occhio Ø est.25, Ø int.14	Tessuto	Rivettato		MF194 C, MF294 C	3300299M93
91052	118x60x6,0 - 5 fori	Tessuto	Forato		MF194 C, MF294 C	3300302M2, 393354X1
91039	Ø int.261, h.60	Tessuto	Rivettata		MF200 C, MF244 C	1452972M91, 2739931M91
91040	210x60x6,0 - 7 fori	Tessuto	Forato		MF200 C, MF244 C	1452976M1, 2739942M1
26700	Ø int.261, h.70	Tessuto	Rivettata	SAME	CENTAURO 55, CENTAURO 60, CENTAURO 65, CORSARO 70, CORSARO 70 SYNCRO	157.5411.3/10
26706	Ø int.261, h.60	Tessuto	Rivettata		CENTAURO 55, CENTAURO 60, CENTAURO 65, CORSARO 70	157.5411.3/10
26740	Ø int.228, h.70	Tessuto	Rivettata		FALCON, MINITAURO 50, MINITAURO 55, MINITAURO 60 FRUTTETO, MINITAURO 60 VIGNETO	146.5411.3/20
26741	210x60x6,0 - 7 fori	Tessuto	Forato		CENTAURO 55, CENTAURO 60, CENTAURO 65, CORSARO 70, CORSARO 70 SYNCRO	135.5412.0
26742	178x60x6,0 - 7 fori	Tessuto	Forato		CENRTAURO 65, CORSARO 70, CENTAURO 55, CENTAURO 60, FALCON, MINITAURO 50, MINITAURO 55, MINITAURO 60 FRUTTETO, MINITAURO 60 VIGNETO	146.5412.0, 157.5412.0
26707	Ø int.241, h.60	Tessuto	Rivettato		CONDOR, FALCON C (DA TEL.4000), SOLAR 55C COMPACT, SOLAR 60C	424.5411.4



Art./Ref.	Dimensioni/Sizes	Tipo/Type	Modello/Model	Brand	Applicazione/Application	Rif. Orig./Orig. Ref.
<b>26851</b>	188x60x6,0 - 7 fori	Tessuto	Forato		CONDOR, FALCON (DA TEL.4000), SOLAR 55C COMPACT, SOLAR 50C	424.5412.0
<b>26705</b>	Ø int.261, h.50 - occhiello Ø est.22, Ø int.14	Tessuto	Rivettata		FALCON C, MINITAURUS 60C, TAURUS C	0.160.5411.2
<b>10564</b>	210x50x6,0 - 7 fori	Tessuto	Forato		FALCON (FINO TEL. 4000), MINITAURUS 60C, TAURUS C	255.2214.6
<b>V0.008.5189.2/1</b>		Originale				0.008.5189.2/10
<b>V0.008.5190.2/1</b>		Originale				0.008.5190.2/10

# 1.7.19 Marmitte, collettori e gomiti

Mufflers, collectors & elbows



## Ricambi & accessori per macchine agricole

SPARE PARTS & ACCESSORIES FOR AGRICULTURAL MACHINE







Tutti gli articoli della presente sezione, prodotti da AMA SPA e/o da terzi per conto di AMA, sono adattabili ("non originali") alle marche indicate ai sensi di quanto previsto dal REG. CE n. 1400/2002. I diritti sui marchi citati appartengono ai legittimi proprietari ed il loro uso ha l'esclusiva finalità di consentire all'utilizzatore la comparazione dei diversi prodotti. All items of this section, manufactured by AMA SPA and/or any third party on behalf of AMA, are adaptable ("non-original") to the brands listed under the provisions of the REG. CE n. 1400/2002. The rights on the trademarks belong to their respective owners and their usage is only aimed to allow the user to compare different products.

**MARMITTE ADATTABILI**

SILENCIEUX ADAPTABLE  
MUFFLERS ADAPTABLE TO  
SCHALLDÄMPFER PASSEND ZU  
SILENCIADORES ADAPTABLE

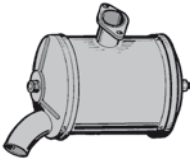
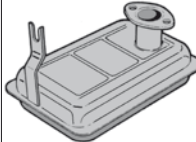
Art./Ref.	Ø Attacco mm/ Attack Ømm	Altezza mm/ Height mm	Note/Notes	Brand	Applicazione/Application	Rif. Orig./Orig. Ref.	Immagine/Image
<b>00561</b>	20	120	Flangia di fissaggio a 2 fori interasse 47 mm//2 holes fixing flange, 47 mm holes distance	<b>ACME</b>	AL 215 HP 5,5, AL 290 HP 7,5, AL 330 HP 10	526.156	
<b>03458</b>	30	290	Flangia a 2 fori interasse 60 mm//2 hole flange 60 mm hole distance		VT 88 - 15 HP (BCS), VT 94	526.104	
<b>91585</b>	<b>55</b>	<b>400</b>	Solo per modelli con cabina Flangia di fissaggio Ø 95,5 con 3 fori Ø 10 mm	<b>CASE</b>	JX1090U, JXU75, JXU85, JXU95,, JXU105, JXU115	47130384	
<b>91586</b>	<b>52</b>	<b>310</b>	Flangia di fissaggio Ø 95,5 con 3 fori Ø 10 mm		QUNATUM 85C, QUANTUM 95C	87744911	
<b>04094</b>	57	1115	Fascetta - Clamp Art. 03387	<b>FENDT</b>	300, 309		
<b>03363</b>	60	820	Tipo quadro lungo/Square type long - Fascetta/Clamp code ama 03387	<b>FIAT</b>	100.90, 1000, 1180, 1280, 1300, 1380, 140, 1580, 180, 1880, 850, 880, 90, 95.55, 955	44905778, 4987847, 4987876, 4997485, 5101709, 5101810, 5109915, 5111563, 5111661, 5112117, 5116897, 5123236, 5134339, 5146414, 5152184	
<b>03402</b>	46	730	Tipo lungo tondo/Round type long - Fascetta/Clamp code ama 03382 - Coperchietto/Cap code ama 05618		30, 300, 350, 40, 420, 440, 45.66, 450, 455, 470, 474, 480, 50, 500, 540, 55.65, 55.66, 570, 60, 60.65, 60.66, 640, 670, 680, 70, 70.65, 70.66, 780, 80.60, 80.65, 80.70	4957068, 4958660, 4980843, 4980847, 4981062, 4981066, 4981162, 4981243, 4981266, 4982306, 4998293, 5011631, 5011632, 5011657, 597983, 597984	
<b>03404</b>	45	500	Tipo corto con parapigioggia - Fascetta Ama cod. 03382 - Coperchietto Ama cod. 05618 - Couvercle Art. 05618/Short type with cap - Clamp ama code 03382		300, 350, 355, 455, 500, 505, 605, 80.50, 80.70	580710	

Art./Ref.	Ø Attacco mm/ Attack Ømm	Altezza mm/ Height mm	Note/Notes	Brand	Applicazione/Application	Rif. Orig./Orig. Ref.	Immagine/Image
04020	60	1050	Flangia quadra a 4 fori interasse 70 mm - 4 hole square flange 70 mm hole distance	FIAT	10 FL, 80, 90, AD 8 - 9 - 10	4964158, 4965720, 4970708, 4970735, 4979464, 4979467, 4981134, 4981139, 592752	
04051	60	530	Con parapioggia/With cap - Fascetta/Clamp ama code 04052		60, 70, 80	554317, 560740	
04054	46	675	Tipo corto con parapioggia - Fascetta Ama cod. 03382 - Coperchietto Ama cod. 05618/Short type with cap - Clamp ama code 03382 - Cap ama code 05618		300, 350, 355, 455, 500, 505, 605, 80.50, 80.70	4981062, 589710	
04055	46	440	Scarico laterale tipo vigneto e frutteto/Side exhaust - Fascetta/Clamp ama code 03382		55.65, 565, 60.65, 65, 665, 70.65, 765, 80.65	5127341	
04075	80	1245	-		1580, 160, 180, 1880, 55, 55.60, 60, 60.66, 70, 70.66, 80, 80.66	5109906, 5109907, 5119906, 5123288	
04092	42	520	Scarico laterale in basso - Prolunga curva art. 03406 - Fascetta art. 02612/Low side exhaust - Bending extension art. 03406 - Clamp art. 02612		45.66, 50, 55.65, 55.66, 60.65, 60.66, 70.65, 70.66, 80.65, 80.66	44905942, 5134942	
04144	46	680	Tipo quadro - Fascetta art. 03382/ Square type - Clamp ama code 03382		446, 45.66, 465, 466, 55, 55.46, 55.66, 565, 566, 570, 580, 60, 60.65, 60.66, 65, 65.46, 65.66, 665, 666, 680, 70, 70.65, 70.66, 765, 766, 780, 80, 80.65, 80.66, 85.55	4997325, 5100920, 5103482, 5122884, 5131866, 5135118, 5157240	
04147	46	680	Fascetta Art. 03382 / Tipo quadro - Super silenziata/Clamp Art. 03382 / Square type - Super silent		446, 45.66, 465, 466, 55, 55.46, 55.66, 565, 566, 570, 580, 60, 60.65, 60.66, 65, 65.46, 65.66, 665, 666, 680, 70, 70.65, 70.66, 765, 766, 780, 80, 80.65, 80.66, 85.55	5100920, 5131866	
04830	44	960	Fascetta Art. 02612/Clamp Art. 02612		AD4FL4, D, FL, L	598384, 79018848	

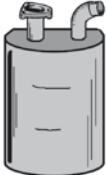





Art./Ref.	Ø Attacco mm/ Attack Ømm	Altezza mm/ Height mm	Note/Notes	Brand	Applicazione/Application	Rif. Orig./Orig. Ref.	Immagine/Image
<b>04846</b>	46	390	Fascetta/Clamp ama code 03382	<b>FIAT</b>	TRATTORI VIGNETO		
<b>14365</b>	60	830	Tipo quadro/Square type - Fascetta/ Clamp ama code 03387		140.90DT, 160.90DT, 180.90DT, 85.90DT, 88.94DT, F130, F140	5146629	
<b>42212</b>	90	1230	Terminale curvo//Curved end	<b>FORD</b>	8630, TW 15, 20	83949806, E4NN5230BA17	
<b>03455</b>	30	250	Flangia a 2 fori interasse a 56 mm / 2 hole flange 56 mm hole distance	<b>JLO</b>	101-152 BETA B210 PER MOTOZAPP		
<b>03456</b>	30	140	Flangia a 2 fori interasse a 56 mm / 2 hole flange 56 mm hole distance		JLO 101-125-152 PER MOTO- ZAPPA		
<b>57926R</b>	52	375		<b>JOHN DEERE</b>	1040, 1640, 1840, 2040, 2050	AL31492	
<b>61447</b>	65		Completa di tubo, fascette e parapioggia		1830, 2020, 2030, 2120, 2130,, 2440, 2640	AL27388	
<b>04059</b>	46	720	Fascetta - Clamp Art. 02612	<b>LANDINI</b>	5000	0973083	
<b>04068</b>	46	530	Flangia triangolare a 3 fori interasse 75 mm - 3 hole triangular flange 75 mm hole distance		CINGOLATI VARI MODELLI	3308555M91	

Art./Ref.	Ø Attacco mm/ Attack Ømm	Altezza mm/ Height mm	Note/Notes	Brand	Applicazione/Application	Rif. Orig./Orig. Ref.	Immagine/Image
<b>04084</b>	55	400	Silenziatore corto altezza cofano/ Short silencer hood height - Fascetta/Clamp ama code 03394	<b>LANDINI</b>	4830, 5500, 5500/R, 5830, 5830/R, 6500, 6500/DT, 6500/R, 6550/DT, 6550/R, 6830, 6830/DT, 7500/DT, 7550/DT, 7830, 7830/DT, 8500/DT, 8550/DT, 8830/DT	894291M2	
<b>04085</b>	55	300	Silenziatore corto altezza cofano - Short silencer hood height Fascetta - Clamp Art. 03394		LANDINI MASSEY FERGUSON		
<b>04088</b>	65	1110	Flangia triangolare interasse 74 mm - Triangular flange 74 mm hole distance		8000 - 9500	1432713M91, 898228M92	
<b>04089</b>	40	750	Flangia triangolare interasse 64 mm/Bride triangulaire, entraxe 64 mm		3000 - 3500	1817867M91	
<b>04090</b>	55	1140	Fascetta art. 03394/Clamp art. 03394		5830, 5860, 5870, 6070, 6870, 6880, 7550, 7830, 7860, 7870, 7880, 8830, 8860, 8870, 8880, ADVANTAGE CAB: 60, ADVANTAGE F.S.: 65, ADVANTAGE F.S.: 75, ADVANTAGE F.S.: 55, ADVANTAGE F.S.: 60, BLIZZARD: 50, BLIZZARD: 60, BLIZZARD: 65, BLIZZARD: 75, BLIZZARD: 85, CINGOLATI: CF6030, CINGOLATI:C6830, CINGOLATI:CF5030, CINGOLATI:CF6830, FRUTTETI 530 F/L/V:4530, FRUTTETI 530 F/L/V:5530, FRUTTETI 530 F/L/V:6530, FRUTTETI 530 F/L/V:7530, FRUTTETI 530 F/L/V:8530, FRUTTETI 560 F/L/V:5560, FRUTTETI 560 F/L/V:6060, FRUTTETI 560 F/L/V:6560, FRUTTETI 560 F/L/V:7560, FRUTTETI 560 F/L/V:8560, NEW SERIE 60: 5860, NEW SERIE 60: 7860, NEW SERIE 60: 8860, SERIE 80, VIGNETI CAB E F.S: 60V	3530335M91	

Art./Ref.	Ø Attacco mm/ Attack Ømm	Altezza mm/ Height mm	Note/Notes	Brand	Applicazione/Application	Rif. Orig./Orig. Ref.	Immagine/Image
<b>04091</b>	50	1040	Fascetta/Clamp ama code 03382	<b>LANDINI</b>	ADATTABILE A VARI MODELLI	1683796M3	
<b>04828</b>	54	1130	Fascetta/Clamp ama code 03394		4830, 5500, 5500/R, 6330/DT, 6500, 6500/R, 6550/R, 6830, 7330, 7500/DT, 7550/DT, 7830/DT, 8500/DT, 8550/DT, 8830/DT, FRUTTETI 530 F/L/V:4530,PRIMA, FRUTTETI 530 F/L/V:5530,PRIMA, FRUTTETI 530 F/L/V:6530,PRIMA, FRUTTETI 530 F/L/V:7530,PRIMA, FRUTTETI 530 F/L/V:8530,PRIMA	1427799M94	
<b>03397</b>	26	160	Flangia a 2 fori interasse 54 mm/ 2 holes flange 54 mm holes distance	<b>LOMBARDINI</b>	503, 520, 522, 530, 6 LD 325, 6 LD 360, LDA 500	5462.089, 5462089	
<b>03398</b>	28	120	Flangia a 2 fori asolati interasse 62 mm/ 2 eyed holes flange 62 mm holes distance		3 LD 510, 4 LD 705, LDA 100, LDA 450, LDA 510, LDA 80, LDA 820, LDA 96, LDA 97	5460.090, 5460090	
<b>03399</b>	28	120	Flangia a 2 fori interasse 56 mm./2 hole flange 56 mm hole distance		3 LD 490, IM490, LDA 400	5460.048, 5460048	
<b>03400</b>	24	150	Flangia a 2 fori interasse 47 mm/ 2 holes flange 47 mm holes distance		IM 300, IM350, LA300, LA350	5460-394	
<b>03460</b>	28	120	Flangia a 2 fori interasse 45 mm - 2 hole flange 45 mm hole distance		C.M. 80, C.M. 90		
<b>04036</b>	46	390	Flangia a 2 fori interasse 70 mm - 2 hole flange 70 mm hole distance Codice 04037 Curva per Art. - Bending for part nr 04036 Ref. Lomb. 9170-028 Fascetta - Clamp Art. 02612		100, 24 LD 640, 5 LD 675, 672, 832, 904, 914 LDA, 96, 97	5461-047	

Art./Ref.	Ø Attacco mm/ Attack Ømm	Altezza mm/ Height mm	Note/Notes	Brand	Applicazione/Application	Rif. Orig./Orig. Ref.	Immagine/Image
04059	46	720	Fascetta - Clamp Art. 02612	MASSEY FERGUSON	200 - 244	0973083	
04068	46	530	Flangia triangolare a 3 fori interasse 75 mm - 3 hole triangular flange 75 mm hole distance		MF 274 CF, MF 367 CF, MF 376 CF, MF 376 XCF, MF 396 CF	3308555M91	
04086	55	1070	Fascetta - Clamp Art. 03394		265, 275, 285, 290, 560, 575, 590, 675 DT, 690	1672994M93, 1699143M92	
04087	55	1385	Fascetta - Clamp Art. 03394		265, 275, 290, 382, 575, 590 FUORI COFANO, DT362	1673835M92, 1675390M92, 3772138M1, 699143M91	
04091	50	1040	Fascetta/Clamp ama code 03382		MF 135, MF 140, MF 148, MF 152, MF 35, MF 550	894291M4	
04828	54	1130	Fascetta/Clamp ama code 03394		133/R, 134/C, 135/R, 154/C, 174/C, 194/C, 234/C, 235/R, 240/R, 245/R, 245DT, 254/C, 254/DT, 274/C, 274/DT, 294/C	1427799M94, 894291M2, 898228M94	
03393	32	130	Flangia a 2 fori interasse 53 mm/2 hole flange 53 mm hole distance		MINARELLI	I190	
03457	30	95	Flangia a 2 fori interasse 53 mm/2 hole flange 53 mm hole distance	PER MOTOZAPPA BENASSI MOD. BL75			



Art./Ref.	Ø Attacco mm/ Attack Ømm	Altezza mm/ Height mm	Note/Notes	Brand	Applicazione/Application	Rif. Orig./Orig. Ref.	Immagine/Image
<b>91585</b>	<b>55</b>	<b>400</b>	Solo per modelli con cabina Flangia di fissaggio Ø 95,5 con 3 fori Ø 10 mm	<b>NEW HOLLAND</b>	T5030, T5040, T5050, T5060,, T5060, TL90A	47130384	
<b>91586</b>	<b>52</b>	<b>310</b>	Flangia di fissaggio Ø 95,5 con 3 fori Ø 10 mm		T4020, T4030, T4040, T4050	87744911 87392493	
<b>04828</b>	54	1130	Fascetta/Clamp ama code 03394	<b>RENAULT</b>	551/45, 651/S, HP 91/DT		
<b>04098</b>	50	1170	Fascetta - Clamp Art. 03394	<b>SAME</b>	TRATTORI VARI SAME		
<b>04099</b>	54	1120	Fascetta - Clamp Art. 03394		TRATTORI VARI SAME		
<b>04100</b>	65	1085	Fascetta Art. 03387/Clamp Art. 03387		TRATTORI VARI SAME		
<b>09857</b>	65	620	Tipo corto - Fascetta Art. 03387/ Short type - Clamp Art. 03387		TRATTORI VARI SAME		

Art./Ref.	Ø Attacco mm/ Attack Ømm	Altezza mm/ Height mm	Note/Notes	Brand	Applicazione/Application	Rif. Orig./Orig. Ref.	Immagine/Image
09858	75	850	Tipo lungo/Long type	SAME	TRATTORI VARI SAME		
V0.190.5657.3			Originale SDF//SDF original			0.190.5657.3	
V0.435.5630.2/1			Originale SDF//SDF original			0.435.5630.2/10	
04061	60	850	Flangia a 2 fori interasse 72 mm/ 2 holes flange 72 mm holes distance	STEYR-	T80	80540048	
04062	46	910	Flangia quadra a 4 fori interasse 60 mm - 4 hole square flange 60 mm hole distance		8060, 8070, 8080, 8090	31100110011, 33700540154, 33700540159, 35700540007	
04095	47	1160	Flangia triangolare a 3 fori interasse 74 mm/3 hole triangular flange 74 mm hole distance		430, 540, 545, 548, 650, 658, 748, 760	192540091	
91586	52-	310	Flangia di fissaggio ø 95,5 con 3 fori ø 10mm		4085 KOMPAKT, 4095 KOMPAKT	87744911	

**KIT SILENZIATORI QUADRI ADATTABILI FIAT**

SILENCIEUX KIT PANNEAU ADAPTABLES FIAT  
 SILENCERS KIT PANEL ADAPTABLES FIAT  
 SILENCER KIT PANEL PASSEND ZU FIAT  
 ESCAPE KIT PANEL ADAPTABLE FIAT

Art./Ref.	Pos.	Note/Notes
84444	1	Kit composto da: 04144 Silenziatore quadro adattabile Fiat 5157240 - 04056 Prolunga curva adattabile Fiat 4997329 - 03382 Collare completo adattabile Fiat 5117613 / Kit Silencer consists of: 04144 Silencer square adaptable Fiat 5157240 - 04056 Curved extension adaptable Fiat 4997329 - 03382 Muffler camp adaptable Fiat 5117613
85444	2	Kit composto da: 04144 Silenziatore quadro adattabile Fiat 5157240 - 04057 Prolunga dritta adattabile Fiat 44905154 - 03382 Collare completo adattabile Fiat 5117613 / Kit Silencer consists of: 04144 Silencer square adaptable Fiat 5157240 - 04057 Straight extension adaptable Fiat 44905154 - 03382 Muffler camp adaptable Fiat 5117613
85496	2	Kit composto da: 03363 Silenziatore quadro adattabile Fiat 5152184 - 04074 Prolunga dritta 750 mm adattabile Fiat 44905774 - 03387 Collare completo adattabile Fiat 5116800 / Kit Silencer consists of: 03363 Silencer square adaptable Fiat 5152184 - 04074 Straight extension adaptable Fiat 44905774 - 03387 Muffler camp adaptable Fiat 5116800
85497	3	Kit composto da: 03363 Silenziatore quadro adattabile Fiat 5152184 - 04072 Prolunga curva 450 mm adattabile Fiat 5100923 - 03387 Collare completo adattabile Fiat 5116800 / Kit Silencer consists of: 03363 Silencer square adaptable Fiat 5152184 - 04072 Curved extension adaptable Fiat 5100923 - 03387 Muffler camp adaptable Fiat 5116800
85498	3	Kit composto da: 03363 Silenziatore quadro adattabile Fiat 5152184 - 04073 Prolunga curva 600 mm adattabile Fiat 4997486 - 03387 Collare completo adattabile Fiat 5116800 / Kit Silencer consists of: 03363 Silencer square adaptable Fiat 5152184 - 04073 Curved extension adaptable Fiat 4997486 - 03387 Muffler camp adaptable Fiat 5116800









**SILENZIATORI SUPERSILENZIATI COMPLETI DI RETE ANTISCOTTATURE**





SILENCIEUX COMPLETS DE GRILLE DE PROTECTION  
 SILENCERS WITH BURNING-SAFE GRILL  
 AUSPUFFE ""SEHR LEISE"" MIT BRANDSCHUTZ  
 SILENCIADORES SUPARSILENCIADOS COMPLETOS CON RED ANTIQUEMADURA

**Caratteristiche:** Questi silenzianti sono dotati di un doppio sistema di silenziamento il quale riduce la rumorosità di oltre 20 dB, facendo rientrare tale valore nei limiti consentiti dalle normative CEE. Inoltre sono forniti completi di rete antiscottatura previste dalle vigenti norme "USL". Tali caratteristiche li rendono conformi alle norme CEE e ne permettono quindi l'applicazione anche nel primo impianto poiché sono omologabili.

**Characteristics:** These silencers are equipped with a double silencing system, reducing noise level by more than 20dB & making them up to the EU norms. They are supplied with protection net, as per "USL" norms. These features allows them to be up to CEE norms. They can, therefore, be used by OEM & be homologated.

Art./Ref.	Note/Notes	Potenza motore/Engine power	Descrizione/Description	Specifiche/Specifications	Altezza mm/Height mm	Immagine/Image
05327	Sezione/Section 118 x 93 mm	50 - 65 cv	Ø interno marmitta 40 mm	Abbattimento sonoro: 23 dB	465	
05328	Sezione/Section 118 x 93 mm	50 - 65 cv	Ø interno marmitta 45 mm	Abbattimento sonoro: 23 dB	465	

Art./Ref.	Note/Notes	Potenza motore/Engine power	Descrizione/Description	Specifiche/Specifications	Altezza mm/Height mm	Immagine/Image
05329	Sezione/Section 118 x 93 mm	60 - 72 cv	Ø interno marmitta 45 mm	Abbattimento sonoro: 25 dB	Silenziatore 685 - Totale 1180	
05330	Sezione/Section 118 x 93 mm	60 - 75 cv	Ø interno marmitta 50 mm	Abbattimento sonoro: 23 dB	465	
05332	Sezione/Section 134 x 109 mm	70 - 85 cv	Ø interno marmitta 55 mm	Abbattimento sonoro: 25 dB	Silenziatore 590 - Totale 1085	
05333	Sezione/Section 118 x 93 mm	70 - 85 cv	Ø interno marmitta 55 mm	Abbattimento sonoro: 25 dB	Silenziatore 685 - Totale 1180	
05336	Sezione/Section 134 x 109 mm	130 - 150 cv	Ø interno marmitta 70 mm	Abbattimento sonoro: 25 dB	Silenziatore 825 - Totale 1320	
05337	Sezione/Section 134 x 109 mm	85 - 120 cv	Ø interno marmitta 60 mm	Abbattimento sonoro: 24 dB	Silenziatore 590 - Totale 1085	
05338	Sezione/Section: 134 x 109 mm	85 - 120 cv	Ø interno marmitta 60 mm	Abbattimento sonoro: 25 dB	Silenziatore 825 - Totale 1320	

Art./Ref.	Note/Notes	Potenza motore/Engine power	Descrizione/Description	Specifiche/Specifications	Altezza mm/Height mm	Immagine/Image
<b>05340</b>	Sezione/Section: 134 x 109 mm	130 - 150 cv	Ø interno marmitta 70 mm	Abbattimento sonoro: 24 dB	Silenziatore 590 - Totale 1085	
<b>05341</b>	Sezione/Section: 192 x 135 mm	150 - 190 cv	Ø interno marmitta 80 mm	Abbattimento sonoro: 25 dB	Silenziatore 960 - Totale 1550	
<b>05342</b>	Sezione/Section: 192 x 135 mm	130 - 165 cv	Ø interno marmitta 76 mm	Abbattimento sonoro: 28 dB	Silenziatore 650	
<b>05343</b>	Sezione/Section: 192 x 135 mm	140 - 180 cv	Ø interno marmitta 80 mm	Abbattimento sonoro: 28 dB	Silenziatore 650	
<b>05344</b>	Sezione/Section: 192 x 135 mm	190 - 240 cv	Ø interno marmitta 89 mm	Abbattimento sonoro: 25 dB	Silenziatore 960 - Totale 1550	

**MARMITTE IN ACCIAIO AL TITANIO RIVESTITE IN ALLUMINIO TIPO DRITTO PICCOLE**

POT D'ÉCHAPPEMENT EN TITANE COFFRÉ EN ALUMINIUM TYPE DROIT PETIT  
 STEEL MUFFLER IN TITANIUM COATED IN ALUMINIUM STRAIGHT TYPE SMALL  
 HNUSPUFFTOPF AUS TITANSTAHL ÜBERZOGEN AUS ALUMINIUM GERADER TYP SMALL  
 TUBO ED ESCAPE EN ACERO AL TITANIO CUBIERTAS EN ALUMINIO TIPO RECTO PEQUEÑO



**Note:** Costruite con speciali acciai al titanio con rivestimento in alluminio. Stampate e aggraffate meccanicamente. Eliminazione delle saldature garantendo maggiore durezza e robustezza. Abbattimento sonoro con elevati rendimenti

**Notes:** Built with special titanium steels with aluminium covering. Mechanically printed and seamed. Higher hardness and strenght guaranteed through the elimination of the welding. Knock down of noise with high efficiency

Art./Ref.	Ø Attacco mm/Attack Ø mm	Potenza motore/Engine power	H mm	Note/Notes
<b>84334</b>	40	50-65	970	Marmitta tubo dritto fascette - Muffler straight pipe clamps diam. 40 mm
<b>59789</b>	45	50-65	970	Marmitta tubo dritto fascette - Muffler straight pipe clamps diam. 45 mm
<b>84336</b>	50	60-75	970	Marmitta tubo dritto fascette - Muffler straight pipe clamps diam. 50 mm
<b>84337</b>	55	70-85	1085	Marmitta tubo dritto fascette - Muffler straight pipe clamps diam. 55 mm
<b>84338</b>	60	85-120	1085	Marmitta tubo dritto fascette - Muffler straight pipe clamps diam. 60 mm
<b>84339</b>	65	110-130	1085	Marmitta tubo dritto fascette - Muffler straight pipe clamps diam. 65 mm
<b>84342</b>	70	130-150	1085	Marmitta tubo dritto fascette - Muffler straight pipe clamps diam. 70 mm

**MARMITTE IN ACCIAIO AL TITANIO RIVESTITE IN ALLUMINIO TIPO DRITTO**

POT D'ÉCHAPPEMENT EN TTANE COFFRÉ EN ALUMINIUM TYPE DROIT

STEEL MUFFLER IN TITANIUM COATED IN ALUMINIUM STRAIGHT

HNUSPUFFTOPF AUS TITANSTAHL ÜBERZOGEN AUS ALUMINIUM GERADER

TUBO ED ESCAPE EN ACERO AL TITANIO CUBIERTAS EN ALUMINIO TIPO RECTO



**Note:** Costruite con speciali acciai al titanio con rivestimento in alluminio. Stampate e aggraffate meccanicamente. Eliminazione delle saldature garantendo maggiore durezza e robustezza. Abbattimento sonoro con elevati rendimenti

**Notes:** Characteristics : Built with special titanium steels with aluminum covering. Mechanically printed and seamed. Higher hardness and strenght guaranteed throught the elimination of the welding. Knock down of noise with high efficiency.

Art./Ref.	Ø Attacco mm/Attack Ø mm	Potenza motore/Engine power	H mm	Note/Notes
59788	45	60-72	1180	Marmitta tubo dritto fascette - Muffler straight pipe clamps diam. 45 mm
59790	50	65-75	1180	Marmitta tubo dritto fascette - Muffler straight pipe clamps diam. 50 mm
84343	55	70-85	1180	Marmitta tubo dritto fascette - Muffler straight pipe clamps diam. 55 mm
59787	60	85-120	1320	Marmitta tubo dritto fascette - Muffler straight pipe clamps diam. 60 mm
84354	65	110-130	1320	Marmitta tubo dritto fascette - Muffler straight pipe clamps diam. 65 mm
84355	70	130-150	1320	Marmitta tubo dritto fascette - Muffler straight pipe clamps diam. 70 mm

**MARMITTE IN ACCIAIO AL TITANIO RIVESTITE IN ALLUMINIO TIPO CURVO PICCOLE**

POT D'ÉCHAPPEMENT EN TTANE COFFRÉ EN ALUMINIUM TYPE COURBE PETIT

STEEL MUFFLER IN TITANIUM COATED IN ALUMINIUM CURVED TYPE SMALL

HNUSPUFFTOPF AUS TITANSTAHL ÜBERZOGEN AUS ALUMINIUM GEKRÜMMTER TYP SMALL

TUBO ED ESCAPE EN ACERO AL TITANIO CUBIERTAS EN ALUMINIO TIPO CURVO PEQUEÑO



**Note:** Costruite con speciali acciai al titanio con rivestimento in alluminio. Stampate e aggraffate meccanicamente. Eliminazione delle saldature garantendo maggiore durezza e robustezza. Abbattimento sonoro con elevati rendimenti

**Notes:** Built with special titanium steels with aluminium covering. Mechanically printed and seamed. Higher hardness and strenght guaranteed throught the elimination of the welding. Knock down of noise with high efficiency.

Art./Ref.	Ø Attacco mm/Attack Ø mm	Potenza motore/Engine power	H mm	Note/Notes
84344	40	50-65	1025	Marmitta tubo curvo fascette - Muffler curved pipe clamps diam. 40 mm
84352	45	50-65	1025	Marmitta tubo curvo fascette - Muffler curved pipe clamps diam. 45 mm
84353	50	60-75	1025	Marmitta tubo curvo fascette - Muffler curved pipe clamps diam. 50 mm
84356	55	70-85	1140	Marmitta tubo curvo fascette - Muffler curved pipe clamps diam. 55 mm
84357	60	85-120	1140	Marmitta tubo curvo fascette - Muffler curved pipe clamps diam. 60 mm
84358	65	110-130	1140	Marmitta tubo curvo fascette - Muffler curved pipe clamps diam. 65 mm
84359	70	130-150	1140	Marmitta tubo curvo fascette - Muffler curved pipe clamps diam. 70 mm

**MARMITTE IN ACCIAIO AL TITANIO RIVESTITE IN ALLUMINIO TIPO CURVO**

POT D'ÉCHAPPEMENT EN TITANE COFFRÉ EN ALUMINIUM TYPE COURBE  
 STEEL MUFFLER IN TITANIUM COATED IN ALUMINIUM CURVED  
 HNSPUFFTOPF AUS TITANSTAHL ÜBERZOGEN AUS ALUMINIUM GEKRÜMMTER TYP  
 TUBO ED ESCAPE EN ACERO AL TITANIO CUBIERTAS EN ALUMINIO TIPO CURVO



**Note:** Costruite con speciali acciai al titanio con rivestimento in alluminio. Stampate e aggraffate meccanicamente. Eliminazione delle saldature garantendo maggiore durezza e robustezza. Abbattimento sonoro con elevati rendimenti

**Notes:** Built with special titanium steels with aluminium covering. Mechanically printed and seamed. Higher hardness and strenght guaranteed throught the elimination of the welding. Knock down of noise with high efficiency

Art./Ref.	Ø Attacco mm/Attack Ø mm	Potenza motore/Engine power	H mm	Note/Notes
84388	45	60-72	1235	Marmitta tubo curvo fascette - Muffler curved pipe clamps diam. 45 mm
84389	50	65-75	1235	Marmitta tubo curvo fascette - Muffler curved pipe clamps diam. 50 mm
84390	55	70-85	1235	Marmitta tubo curvo fascette - Muffler curved pipe clamps diam. 55 mm
84391	60	85-120	1400	Marmitta tubo curvo fascette - Muffler curved pipe clamps diam. 60 mm
84392	65	110-130	1400	Marmitta tubo curvo fascette - Muffler curved pipe clamps diam. 65 mm
84393	70	130-150	1400	Marmitta tubo curvo fascette - Muffler curved pipe clamps diam. 70 mm

**COLLETTORI SCARICO PER MOTORI ADATTABILI FIAT**

COLLECTEURS D'ÉCHAPPEMENT MOTEURS ADAPTABLE FIAT  
 REAR MUFFLER COLLECTOR ADAPTABLE FIAT  
 AUSPUFFSAMMLER PASSEND ZU FIAT MOTOREN  
 COLECTORES DE ESCAPE PARA MOTORES ADAPTABLE FIAT



Art./Ref.	Brand	Applicazione/Application	Rif. Orig./Orig. Ref.
10516	FIAT	350, 40, 420, 440, 446, 45.66, 450, 455, 465, 470, 474, 480, 50, 500, 505C, 540, 55, 55.46, 55.66, 565, 566, 60, 60.65, 60.66, 80.46, 80.50, 80.56, 80.60	4607842, 4768783

**GUARNIZIONI COLLETTORE SCARICO PER MOTORI ADATTABILI FIAT**

JOINT COLLECTEUR ÉCHAPPEMENT POUR MOTEUR ADAPTABLE FIAT  
 COLLECTOR GASKETS ADAPTABLE FIAT ENGINES  
 DICHTUNGEN KOLLEKTORAUSPUFF FEUR PASSEND ZU FIAT MOTOREN  
 GUARNICIONES COLECTOR DE ESCAPE PARA MOTORES ADAPTABLE FIAT



Art./Ref.	Brand	Applicazione/Application	Rif. Orig./Orig. Ref.
10515	FIAT	TUTTI I MODELLI	4601981, 4813566, 4849327, 98428397, 98489690

**COLLETTORI SCARICO PER MOTORI ADATTABILI FIAT**

COLLECTEURS D'ÉCHAPPEMENT MOTEURS ADAPTABLE FIAT  
 REAR MUFFLER COLLECTOR ADAPTABLE FIAT  
 AUSPUFFSAMMLER PASSEND ZU FIAT MOTOREN  
 COLECTORES DE ESCAPE PARA MOTORES ADAPTABLE FIAT



Art./Ref.	Brand	Applicazione/Application	Rif. Orig./Orig. Ref.
10517	FIAT	605C, 640, 65, 65.46, 65.66, 665, 666, 70, 70.65, 765, 766, 80, 80.65, 80.66, 80.70, 80.76, 85.55	4606570

**GUARNIZIONI GOMITO SCARICO PER MOTORI ADATTABILI FIAT**

JOINT COURBE ÉCHAPPEMENT POUR MOTEUR ADAPTABLE FIAT  
 GASKETS FOR EXHAUSTING ELBOW PIPE ADAPTABLE FIAT ENGINES  
 DICHTUNGEN BOGEN AUSPUFF PASSEND ZU FIAT MOTOREN  
 GUARNICIONES CODO DE ESCAPE PARA MOTORES ADAPTABLE FIAT



Art./Ref.	Note/Notes	Brand	Applicazione/Application	Rif. Orig./Orig. Ref.
10675	Guarnizione Rif. 5152380/Sealing Ref. 5152380	FIAT	300, 350, 400, 450, 500, 540, 550, 580, 600, 650	4610742, 5118183, 5152380

**COLLETTORI A GOMITO DI SCARICO ADATTABILI FIAT**

COLLECTEURS D'ÉCHAPPEMENT MOTEURS ADAPTABLE FIAT  
 REAR MUFFLER COLLECTOR ADAPTABLE FIAT  
 AUSPUFFSAMMLER PASSEND ZU FIAT-MOTOREN  
 COLECTORES DE ESCAPE PARA MOTORES ADAPTABLE FIAT



Art./Ref.	Note/Notes	Brand	Applicazione/Application	Rif. Orig./Orig. Ref.
04079	Utilizzabile con silenziatore / Suitable for silencer part ama code 04055	FIAT	45.66, 465, 55.65, 55.66, 60.65, SERIE 66	44905487, 5128108, 5164290

**COLLETTORI A GOMITO DI SCARICO PER MOTORI ADATTABILI FIAT**

COLLECTEURS D'ÉCHAPPEMENT MOTEURS ADAPTABLE FIAT  
 REAR MUFFLER COLLECTOR ADAPTABLE FIAT  
 AUSPUFFSAMMLER PASSEND ZU FIAT MOTOREN  
 COLECTORES DE ESCAPE PARA MOTORES ADAPTABLE FIAT



Art./Ref.	Note/Notes	Brand	Applicazione/Application	Rif. Orig./Orig. Ref.
04082	Curvato ad "U" inclinato in avanti / "U" shaped forward inclined	FIAT	446, 466, 55.46, 566, 60.66, 65.46, 65.66, 666, 70.66, 766, 80.66, SERIE 66	44905153, 5121925, 5164163



**COLLETTORI A GOMITO DI SCARICO PER MOTORI ADATTABILI FIAT**

COLLECTEURS D'ÉCHAPPEMENT MOTEURS ADAPTABLE FIAT  
 REAR MUFFLER COLLECTOR ADAPTABLE FIAT  
 AUSPUFFSAMMLER PASSEND ZU FIAT MOTOREN  
 COLECTORES DE ESCAPE PARA MOTORES ADAPTABLE FIAT



Art./Ref.	Note/Notes	Brand	Applicazione/Application	Rif. Orig./Orig. Ref.
<b>04083</b>	Inclinato in avanti, tipo lungo doppia curva/ Forward inclined long type double bending	<b>FIAT</b>	45.66, 465, 55.65, 55.66, 60.65, SERIE 66	5104820, 5151556, 5164167

**COLLETTORI A GOMITO DI SCARICO PER MOTORI ADATTABILI FIAT**

COLLECTEURS D'ÉCHAPPEMENT MOTEURS ADAPTABLE FIAT  
 REAR MUFFLER COLLECTOR ADAPTABLE FIAT  
 AUSPUFFSAMMLER PASSEND ZU FIAT MOTOREN  
 COLECTORES DE ESCAPE PARA MOTORES ADAPTABLE FIAT



Art./Ref.	Note/Notes	Brand	Applicazione/Application	Rif. Orig./Orig. Ref.
<b>06218</b>	Gomito scarico cingolati e trattori/Exhaust elbow	<b>FIAT</b>	420, 440, 450, 455, 480, 500, 505, 540, 605, 640	4981674, 5011655, 5102917, 598592
<b>14398</b>	Gomito scarico cingolati e trattori - Delivery elbow track & tractors		850	44011746, 4998652

**COLLETTORI A GOMITO DI SCARICO ADATTABILI PER MOTORI FIAT**

COLLECTEURS D'ÉCHAPPEMENT ADAPTABLE MOTEURS FIAT  
 REAR MUFFLER COLLECTOR ADAPTABLE FOR FIAT  
 AUSPUFFSAMMLER PASSEND ZU FIAT MOTOREN  
 COLECTORES DE ESCAPE ADAPTABLE PARA MOTORES FIAT



Art./Ref.	Note/Notes	Brand	Applicazione/Application	Rif. Orig./Orig. Ref.
<b>06261</b>	Gomito curvato ad "U"/Shaped elbow "U"	<b>FIAT</b>	DALLA SERIE 250 ALLA SERIE 670	5101206, 5109917, 598350

**COLLETTORI A GOMITO DI SCARICO ADATTABILI LANDINI**

COLLECTEURS D'ÉCHAPPEMENT MOTEURS ADAPTABLE LANDINI  
 REAR MUFFLER COLLECTOR ADAPTABLE LANDINI  
 AUSPUFFSAMMLER PASSEND ZU LANDINI-MOTOREN  
 COLECTORES DE ESCAPE PARA MOTORES ADAPTABLE LANDINI



Art./Ref.	Note/Notes	Brand	Applicazione/Application
<b>02148</b>	Collettore a gomito prolungato - Elbow long manifold	<b>LANDINI</b>	CINGOLATI

**ADATTATORE DA MARMITTA FIAT A LANDINI**

ADAPTATEUR POUR ECHAPPEMENTS FIAT ET LANDINI

MUFFLER ADAPTOR FOR FIAT AND LANDINI

AUSPUFFADAPTER FIAT-LANDINI TRAKTORE

ADAPTADOR DE TUBO DE ESCAPE FIAT A LANDINI



Art./Ref.	A mm	B mm	Note/Notes
05676	46	56	Riduzione marmitta Fiat/Landini/Reduction muffler Fiat/Landini

**TUBO SCAR.SOTTOCARRO ADATTABILE FIAT 44905168**

POT D'ECHAPPEMENT ADAPTABLE POUR FIAT 44905168

INFERIOR DISCHARGE HOSE ADAPTABLE TO FIAT 44905168

NIEDRIGES AUSSTOSSROHR PASSEND ZU FIAT 44905168

TUBO SCAR.SOTTOCARRO ADAPTABLE PARA FIAT 44905168



Art./Ref.	Ø Attacco mm/ Attack Ø mm	Brand	Applicazione/Application	Rif. Orig./Orig. Ref.	Note/Notes
04077	45	FIAT	1300, 350, 420, 446, 450, 480, 500, 540, 55.46, 640, 65.46	44905168, 4953808, 4956043, 4956048, 4958669, 4959046, 4964092, 4981677, 4982305, 4984214, 5011635, 5011641, 5011845, 5101806, 598314, 598348, 598354	Tipo / Type: Tubo scarico sottocarro Rif. 44905168 / Inferior discharge hose Ref. 44905168

**FLANGE PER TUBO SOTTOCARRO ADATTABILE FIAT**

FLASQUES POUR POT D'ECHAPPEMENT INFERIEUR ADAPTABLE FIAT

FLANGES FOR INFERIOR HOSE ADAPTABLE TO FIAT

FLANSCHEN FUER NIEDRIGES ROHR PASSEND ZU FIAT

COLLARES PARA TUBO INFERIOR ADAPTABLE FIAT



Art./Ref.	Brand	Applicazione/Application	Rif. Orig./Orig. Ref.	Note/Notes
04070	FIAT	DAL 250 AL 670	44905167, 5011638, 596647	Tubo sottocarro - Bottom pipe Art. 04077
04071		OM DAL 650 AL 1000	596752	Tubo sottocarro - Bottom pipe Art. 04077

**GRIGLIE METALLICHE ANTISCOTTATURE**

GRILLES DE PROTECTION

METAL BURNING-SAFE GRILL

BRANDSCHUTZ FÜR AUSPUFF

CRIBAS METÁ LICAS ANTIQUEMADURAS

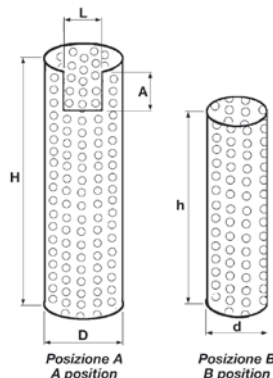

**Note:** Caratteristiche : Complete di 4 bulloni per il fissaggio. Pronte al montaggio e di facile installazione, rispondono alle normative "CEE" ed alle esigenze di sicurezza "USL". Applicabili e adattabili su tutti i tipi silenziatori e su marmitte e prolunghe montate di serie sui motori FIAT.

**TIPO A:** per marmitte con uscita curva.

**TIPO B:** per marmitte con uscita diritta o per prolunghe.

**N.B. Gli articoli 05044 e 05045 sono formati da entrambi i modelli di rete (A+B) ricavati in un unico pezzo, per questo sono applicabili a silenziatori completi di prolunga ma esclusivamente diritta, per permettere alla rete di essere infilata dall'alto nel silenziatore stesso, e successivamente bloccata.**

**Notes:** Characteristics : Supplied with 4 bolts for fixing. Ready for fixing & easy to install, they are up to "CEE" norms & safety norms by "USL". Suitable and adaptable for all sort of silencers & for exhausts + extensions fixed on FIAT engines from factory.

**TYPE A:** for silencers with bended outlet.

**TYPE B:** for silencers with straight outlet or extensions.

**N.B. Part.nr. 05044 & 05045, are made of both net models (A+B). They are made of 1 single pc. That is why they can be fixed on silencer with straight extension only, to allow the net to be lowered around the silencer from above & be fixed afterward.**

Art./Ref.	Pos.	D mm	H mm	Note/Notes	Brand	Applicazione/Application
05040	B	125	350		A.M.A.	ART. 04828-04085-04846
05041	B	125	500			ART. 03404-04059-04054
05042	A	125	800	LxA 90 x 90 mm		ART. 04144-04147-03402
05043	A	140	900	LxA 100 x 100 mm		ART. 03363-04086
05044	A + B	125 pos. A + 68 pos. B	800 pos. A + 600 pos. B	LxA 90 x 90 mm		ART. 04144-04147 + PROL 04057
05045	A + B	140 pos. A - 78 pos. B	900 pos. A - 600 pos. B	LxA 100 x 100 mm		ART. 03363 + PROLUNGA 04074
05046	B	68	320			ART. 03406 E PROLUNGHE D.48-50
05047	B	68	500			ART. 04056 E PROLUNGHE D.48-50
05048	B	68	630			ART. 04057 E PROLUNGHE D.48-50
05049	B	78	300			ART. 04072 E PROLUNGHE D.60-63
05050	B	78	500			ART. 04073 E PROLUNGHE D.60-63
05051	B	78	630			ART. 04074 E PROLUNGHE D.60-63

**GRIGLIE ANTISCOTTATURA PER MARMITTE**

GRILLE DE PROTECTION

PROTECTION GRID

BRANDSCHUTZ

REJILLA DE PROTECCIÓN



Art./Ref.	Note/Notes
59013	Protezione Silenziatore 560x110x120/Muffler protection 560x110x120
59014	Protezione silenziatore 670x133x127/Muffler protection 670x133x127
78820	Protezione Silenziatore 720x150x190/Muffler protection 720x150x190

**COPERCHIETTI PARAPIOGGIA ADATTABILI FIAT**

COUVERCLE PARAPLUIE ADAPTABLE POUR FIAT  
 PROTECTION CUP FOR SILENCER ADAPTABLE TO FIAT  
 SCHUTZDECKEL FÜR AUSPUFFE PASSEND ZU FIAT  
 TAPITAS GUARDALLUVIAS ADAPTABLE FIAT



Art./Ref.	Ø Attacco mm/Attack Ø mm	Note/Notes	Brand	Applicazione/Application	Rif. Orig./Orig. Ref.
05618	46-50	Tipo originale a coperchietto con perno/Cover with pin	FIAT - A.M.A.	ART. 03402-03404-04054, 300, 350, 355, 455, 500, 505, 605, 80.50, 80.70, DAL 250 AL 780, SERIE 66	4953217, 5011654
05639	40-43	Tipo a bilancere con fascetta/Clamp diam. 40-43 mm	A.M.A.	ART. 04095	
05640	48-51	Tipo a bilancere con fascetta/Clamp diam. 48-51 mm	FIAT	TRATTORI FIAT 1580 VARIE	5116904, 5140886
05642	52-55	Tipo a bilancere con fascetta/Clamp diam. 52-55 mm		VARIE	
05643	56-59	Tipo a bilancere con fascetta/Clamp diam. 56-59 mm		VARIE	
05648	60-63	Tipo a bilancere con fascetta/Clamp diam. 60-63 mm		VARIE	5116898, 5123234, 5134341, 5140885
12542	76	Tipo a bilancere con fascetta Ø 76 mm/Clamp diam. 76 mm		VARIE	

**COLLARI PER MARMITTA**

COLLIERS POUR POT D'ÉCHAPPEMENT  
 MUFFLERS CLAMPS  
 AUSPUFFSCHELLE  
 ABRAZADERAS PARA TUBO DE ESCAPE



Art./Ref.	Note/Notes	Brand	Applicazione/Application	Rif. Orig./Orig. Ref.
03382	Tipo ad 2 pezzi - Diam. 46-49 mm - Type 2 pcs - Diam. 46-49 mm Silenziatori - Silencer 04144-03402-03404-04054-04055-04846-04091-04830 Prolunghe - Extension 03406-04056-04057	FIAT	30-40-50-55-60-70, 300-350, 420-440-450-455-470-480, 45.66, 540-570-580, 55.65, 55.66, 60.65, 60.66, 640-670-680-780, 70.65, 70.66, 80.60, 80.65, 80.70	4980842, 4998798, 4998800, 5101436, 5101438, 5102706, 5117613
03387	Tipo ad 2 pezzi - Diam. 60-65 mm - Type 2 pcs - Diam. 60-65 mm Silenziatori - Silencer 03363-04094-04100 Prolunghe - Extension 04072-04073-04074	FIAT	80-90-100-110-115-130-140, 880-995-980-1180-1280-1380	4998799, 5101437, 5116800
03394	Tipo ad 1 pezzo - Diam. 52-55 mm - Type 1 pc - Diam. 52-55 mm Silenziatori - Silencer 04084-04085-04828-04087-04090-04098-04099	FIAT	805	
04052	Tipo ad 1 pezzo - Diam. 63-68 mm - Type 1 pc - Diam. 63-68 mm Silenziatori - Silencer 04051	FIAT	50-60-70	596913

**PROLUNGHE CURVATE PER MARMITTE ADATTABILI FIAT**

RALLONGEMENTS COURBES SILENCIEUX ADAPTABLE FIAT  
 CURVED EXTENSION ADAPTABLE FIAT MUFFLERS  
 GEBogene VERLÄNGERUNGEN PASSEND ZU FIAT-AUSPUFF  
 ALARGADERAS CURVAS PARA TUBO DE ESCAPE ADAPTABLE FIAT

Art./Ref.	Ø Attacco mm/ Attack Ø mm	H mm	Note/Notes	Brand	Applicazione/Application	Rif. Orig./Orig. Ref.
<b>03406</b>	46	650	Silenziatore - Silencer Art. 03402	<b>FIAT</b>	40-420-440-450-480-640, DAL 250 AL 670	4980841, 5011633, 5117022
<b>04056</b>	46	700	Silenziatore - Silencer Art. 04144		465C, 565c, 665C, 765C, DAL 570 AL 780, SERIE 66	4997329
<b>04072</b>	60	450	Silenziatore - Silencer Art. 03363		DAL 850S AL 1380, SERIE 66.90	4987597, 5011668, 5100923
<b>04073</b>	<b>60</b>	<b>600</b>	Silenziatore - Silencer Art. 03363		850-880-980, DAL 850S AL 1380	4997486

**PROLUNGHE DIRITTE PER MARMITTE ADATTABILI FIAT**

RALLONGEMENTS DROITS SILENCIEUX ADAPTABLE FIAT  
 STRAIGHT EXTENSION ADAPTABLE FIAT MUFFLERS  
 RECHTE VERLÄNGERUNGEN PASSEND ZU FIAT-AUSPUFF  
 ALARGADERAS RECTAS PARA TUBO DE ESCAPE ADAPTABLE FIAT



Art./Ref.	Ø Attacco mm/ Attack Ø mm	H mm	Note/Notes	Brand	Applicazione/Application	Rif. Orig./Orig. Ref.
<b>04057</b>	46	600	Silenziatore - Silencer Art. 04144	<b>FIAT</b>	465C, 565c, 663C, 665C, 765C, DAL 570 AL 780, SERIE 66	44905154, 5011645, 5116792, 5117292, 5122888
<b>04074</b>	60	750	Silenziatore - Silencer Art. 03363		DAL 850S AL 1380, SERIE 66.90	44905774, 5111564, 5111566, 5116797, 5123235

**PROLUNGHE DRITTE**

ALLONGEMENTS DROITS  
 EXTENSIONS STRAIGHT  
 EXTENSIONS STRAIGHT  
 EXTENSIONES DE RECTO

Art./Ref.	Ø Attacco mm/ Attack Ø mm	H mm
<b>84372</b>	40	540
<b>84360</b>	48	540
<b>84362</b>	51	540
<b>84364</b>	53	540
<b>84366</b>	58	545
<b>84368</b>	65	545
<b>84370</b>	67	545

**PROLUNGHE CURVE**

COURBES D'EXTENSION  
 EXTENSION CURVES  
 DEHNUNGSKURVEN  
 CURVAS DE EXTENSIÓN

Art./Ref.	Ø Attacco mm/ Attack Ø mm	H mm/H mm
<b>84373</b>	40	600
<b>84361</b>	48	600
<b>84363</b>	51	600
<b>84365</b>	53	600
<b>84367</b>	58	640
<b>84369</b>	65	640
<b>84371</b>	67	640



**FASCETTE**

BANDES  
BANDS  
BANDS  
BANDAS



Art./Ref.	Ø Attacco mm/Attack Ø mm	Note/Notes
82361	43-45	Fascette / Bands 43-45 mm
82362	46-47	Fascette / Bands 46-47 mm
82364	51-52	Fascette / Bands 51-52 mm
82365	53	Fascette / Bands 53 mm
82366	54-55	Fascette / Bands 54-55 mm/
82367	56-57	Fascette / Bands 56-57 mm
82368	58-60	Fascette / Bands 58-60 mm
82369	61-62	Fascette / Bands 61-62 mm/
82370	63-65	Fascette / Bands 63-65 mm
82371	66-67	Fascette / Bands 66-67 mm
82372	68-69	Fascette / Bands 68-69 mm
82373	70-72	Fascette / Bands 70-72 mm/
82374	73-76	Fascette / Bands 73-76 mm
82375	83-85	Fascette / Bands 83-85 mm
82376	86-89	Fascette / Bands 86-89 mm
82377	92-94	Fascette / Bands 92-94 mm
82378	95-98	Fascette / Bands 95-98 mm
82379	105-108	Fascette / Bands 105-108 mm
82380	109-112	Fascette / Bands 109-112 mm
82389	117-120	Fascette / Bands 117-120 mm
82381	121-123	Fascette / Bands 121-123 mm
82382	124-127	Fascette / Bands 124-127 mm
82383	128-131	Fascette / Bands 128-131 mm
82384	133-136	Fascette / Bands 133-136 mm
82385	137-140	Fascette / Bands 137-140 mm

**PARAPIOGGIA TIPO SILENZIATO**

PROTECTION PARAPLUIE TYPE SILENCIEUX  
WATER SAFE SOUND DEAD  
GERÄUSCHARMER SCHUTZ  
PARALLUVIA TIPO SILENCIADO



Art./Ref.	Ø Attacco mm/Attack Ø mm	Note/Notes
82386	40	Parapioggia silenziato/ Water safe sound dead Diam. 40 mm
82387	42	Parapioggia silenziato / Water safe sound dead Diam. 42 mm
82349	45	Parapioggia silenziato / Water safe sound dead Diam. 45 mm
60041	48	Parapioggia silenziato / Water safe sound dead Diam. 48 mm
60042	50	Parapioggia silenziato / Water safe sound dead Diam. 50 mm
82350	55	Parapioggia silenziato / Water safe sound dead Diam. 55 mm

Art./Ref.	Ø Attacco mm/Attack Ø mm	Note/Notes
60043	60	Parapioggia silenziato / Water safe sound dead Diam. 60 mm
82351	65	Parapioggia silenziato / Water safe sound dead Diam. 65 mm
82352	70	Parapioggia silenziato / Water safe sound dead Diam. 70 mm
82353	76	Parapioggia silenziato / Water safe sound dead Diam. 76 mm
82354	80	Parapioggia silenziato / Water safe sound dead Diam. 80 mm
82355	89	Parapioggia silenziato / Water safe sound dead Diam. 89 mm
82388	100	Parapioggia silenziato / Water safe sound dead Diam. 100 mm
82356	102	Parapioggia silenziato / Water safe sound dead Diam. 102 mm
82357	110	Parapioggia silenziato / Water safe sound dead Diam. 110 mm
82358	114	Parapioggia silenziato / Water safe sound dead Diam. 114 mm
82359	121	Parapioggia silenziato / Water safe sound dead Diam. 121 mm
82360	130	Parapioggia silenziato / Water safe sound dead Diam. 130 mm

**FASCETTA A CAVALLOTTO**

PINCE A COLLIER  
CLAMP A CLAMP  
KLEMME EINE CLAMP  
ABRAZADERA

Art./Ref.	Ø Attacco mm/Attack Ø mm
82390	35-37
82391	38-39
82392	40-42
82393	43-44
82394	45-47
82395	48-50
82396	51-53
82397	54-56
82398	57-59
82399	60-62
82400	63-65
82401	66-68
82402	69-71
82403	72-75
82404	76-79
82405	80-85
82406	86-88
82407	89-91
82408	92-97
82409	98-105
82410	106-109
82411	110-117
84332	118-124
84333	128-130



**TUBI FLESSIBILI IN ACCIAIO ZINCATO PER SCARICO MOTORI (ROTOLI DA 6 MT.)**

TUYAU FLEXIBLE EN ACIER GALVANISÉ POUR DÉCHARGÉ MOTEURS (ROULEAUX DE 6 MT.)  
 FLEXIBLE PIPE IN STEEL GALVANIZED FOR UNLOADING MOTOR (ROLLS OF 6 MT.)  
 FLEXIBLES ROHR IN STAHL GALVANISIERT, UM MOTOR AUSZULADEN (ROLLS VON 6 MT.)  
 TUBO FLEXIBLE EN ACERO GALVANIZADO PARA DESCARGAR MOTOR (ROLLOS DE 6 MT.)



**Note:** Lo spessore della regetta e' 0,5 mm.  
 Disponibile su richiesta in materiale inox in 0,4 mm

**Notes:** The thickness is 0,5 mm.

On demand it is also available in stainless steel and 0,4 mm thick

Art./Ref.	Ø Attacco mm/Attack Ø mm	D mm
82337	30	35
82338	35	40
82339	40	45
61540	45	50
61541	50	55
82340	55	60
61542	60	65
82341	65	70
82342	70	75
61536	76	81
82343	80	85
82344	85	90
82345	89	94
61537	102	107
82346	114	119
82347	121	126
82348	130	135

**MANICOTTI MASCHIO**

ACCOUPEMENTS MÂLE  
 MALE COUPLINGS  
 MÄNNLICHE KUPPLUNGEN  
 ACOPLAMIENTOS MACHO

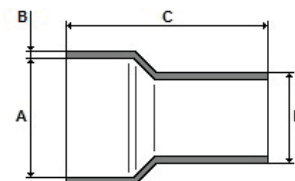

Art./Ref.	A mm	B mm	C mm	D mm
93276	35	1,5	70	30
93277	40	1,5	70	35
93278	45	1,5	70	40
93279	50	1,5	70	45
93280	55	1,5	70	50
93281	60	1,5	80	55
93282	65	1,5	80	60
93283	70	1,5	80	65
93284	75	1,5	80	70
93285	81	1,5	90	76
93286	85	1,5	90	80
93287	90	1,5	90	85
93288	94	1,5	90	89
93289	100	1,5	90	95
93290	107	2	100	102
93291	115	2	100	110

**MANICOTTI FEMMINA**

ACCOUPEMENTS FEMME  
 FEMALE COUPLINGS  
 WEIBLICHE KUPPLUNGEN  
 ACOPLAMIENTOS HEMBRA

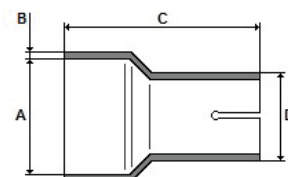

Art./Ref.	A mm	B mm	C mm	D mm
93376	35	1,5	70	30,6
93377	40	1,5	70	35,6
93378	45	1,5	70	40,6
93379	50	1,5	70	45,6
93380	55	1,5	70	50,6
93381	60	1,5	80	55,6
93382	65	1,5	80	60,6
93383	70	1,5	80	65,6
93384	75	1,5	80	70,6
93385	81	1,5	90	76,6
93386	85	1,5	90	80,6
93387	90	1,5	90	85,6
93388	94	1,5	90	89,6
93389	100	1,5	90	95,6
93390	107	2	100	103
93391	115	2	100	111

# 1.7.20 Sistema di raffreddamento

Cooling system



## Ricambi & accessori per macchine agricole

SPARE PARTS & ACCESSORIES FOR AGRICULTURAL MACHINE

Tutti gli articoli della presente sezione, prodotti da AMA SPA e/o da terzi per conto di AMA, sono adattabili ("non originali") alle marche indicate ai sensi di quanto previsto dal REG. CE n. 1400/2002. I diritti sui marchi citati appartengono ai legittimi proprietari ed il loro uso ha l'esclusiva finalità di consentire all'utilizzatore la comparazione dei diversi prodotti. All items of this section, manufactured by AMA SPA and/or any third party on behalf of AMA, are adaptable ("non-original") to the brands listed under the provisions of the REG. CE n. 1400/2002. The rights on the trademarks belong to their respective owners and their usage is only aimed to allow the user to compare different products.



**POMPE ACQUA ADATTABILE**
*POMPEN A EAU ADAPTABLE*
*WATER PUMPS ADAPTABLE*
*WASSERPUMPEN PASSEND ZU*
*BOMBAS DE AGUA ADAPTABLE*
**Note:** Pompe acqua complete di guarnizioni

**Notes:** Water pumps complete with gaskets

Art./Ref.	Brand	Applicazione/Application	Rif. Orig./Orig. Ref.	Immagine/Image
10150	CASE	475	3118125R91	
29705		JX100U, JX1060V, JX1095N, JX1095V, JX55, JX65, JX70U, JX75, JX80U, JX85, JX90U	99454833	
40530		C70, C80, C90, CX80, CX90	293515A1, 328361A1	

05686	FIAT	FL4 - FL5 - FD5 - FB7 - FD7, FL7 - FR7 - FR9 - FR10 - FE12, FR12 - FE14 - FE16 - FE18, S60 - FG65A, 100.90 - 100.90DT, 110.90 - 110.90DT, 115.90 - 115.90DT, 130.90 - 130.90DT, 140.90 - 140.90DT, 45.66 - 45.66DT, 45.76V - 45.76V DT, 480, 50.66 - 50.66DT, 55.46 - 55.46DT, 55.66 - 55.66DT, 55.66F - 55.66F DT, 55.66LP - 55.66LP DT, 55.66V - 55.66V DT, 55.76F - 55.76F DT, 55.88 - 55.88DT, 55.90 - 55.90DT, 60.46 - 60.46DT, 60.66 - 60.66DT, 60.66F - 60.66F DT, 60.66LP - 60.66LP DT, 60.76F - 60.76F DT, 60.88 - 60.88DT, 60.90 - 60.90DT, 640, 65.46 - 65.46DT, 65.66 - 65.66DT, 65.88 - 65.88DT, 65.90 - 65.90DT, 70.66 - 70.66DT, 70.66F - 70.66F DT, 70.66LP - 70.66LP DT, 70.66V - 70.66V DT, 70.76F - 70.76F DT, 70.76LP - 70.76LP DT, 70.76V - 70.76V DT, 70.88 - 70.88DT, 70.90 - 70.90DT, 80.66 - 80.66DT, 80.66F - 80.66F DT, 80.76F - 80.76F DT, 80.88 - 88.88DT, 80.90 - 80.90DT, 85.90 - 85.90DT, 90.90 - 90.90DT, F100 - F100DT, F110 - F110DT, F120 - F120DT, F130 - F130DT, TK55.65F, TK55.65M, TK55.65V, TK55.75F, TK55.75M, TK55.75V, TK55.85F, TK55.85M, TK55.85V, TK60.65, TK60.65M, TK60.65V, TK60.75, TK60.75M, TK60.75V, TK60.85F, TK60.85V, TK70.65, TK70.65M, TK70.75, TK70.75M, TK80.65, TK80.75, TK85.55, TK95.55	4813370, 4784454, 98403015, 98403016, 98497117	
05687		1000, 1000 SUPER, 1000DT, 1000N, 1180, 1180DT, 1280, 1280DT, 1380, 1380DT, 250, 250DT, 255C, 300, 300DT, 300J, 350, 355 C, 400, 400DT, 420, 420DT, 440, 440DT, 446, 446DT, 450, 450DT, 455 SUPER, 455C, 460, 465C, 466, 470, 474, 480, 480.8, 500, 505C, 540, 550, 555C, 565C, 566, 570, 600, 605C, 640, 665C, 666, 670, 765C, 766, 880-5, 980, 980DT	4612675, 4655054, 4679242, 4679303, 82847745, 93191101	
10136		580, 580DT, 680, 680DT, 780, 780DT, 855C	1930925, 4696707, 82847744	
10137		211RB, 215C, 400, 400DT, 411, 411R, 415, 415DT, 421, 431, FL4	566997	
10141		655, SOM650, SOM670, SOM750, SOM800, SOM805C, SOM850	8822883, 8829787	











Art./Ref.	Brand	Applicazione/Application	Rif. Orig./Orig. Ref.	Immagine/Image
15129		SOM35, SOM40, SOM50, SOM511, SOM512, SOM612, SOM615, SOM715	577837	
29705	FIAT	140.90 - 140.90DT, 45.66S - 45.66S DT, 50.66S - 50.66S DT, 50.86S V - 50.86S V DT, 50.86V - 50.86V DT, 55.56 - 55.56DT, 55.66S - 55.66S DT, 55.86F - 55.86F DT, 55.86S V - 55.86S V DT, 55.86V - 55.86V DT, 56.66S - 56.66S DT, 60.56 - 60.56DT, 60.66S - 60.66S DT, 60.86F - 60.86F DT, 60.86S V - 60.86S V DT, 60.86V - 60.86V DT, 62.86F - 62.86F DT, 65.56 - 65.56DT, 65.66S - 65.66S DT, 70.56 - 70.56DT, 70.66S - 70.66S DT, 70.86S V - 70.86S V DT, 70.86V - 70.86V DT, 72.86F - 72.86F DT, 72.86LP - 72.86LP DT, 80.66S - 80.66S DT, 82.86F - 82.86F DT, 82.86LP - 82.86LP DT	8013363, 99454833	
42999		FE16 - FE18 - FA120 - FH120, FL10 - FR10 - FR11 - FE12, FL4 - FD5 - FL5 - FB7 - FD7, FL7 - FR7 - FD9 - FR9 - FD10, FR130 - FH150 - FH200, 100.90 - 100.90DT, 110.90 - 110.90DT, 140.90 - 140.90DT, 45.66S - 45.66S DT, 50.66S - 50.66S DT, 50.86S - 50.86S DT, 50.86V - 50.86V DT, 55.56 - 55.56DT, 55.66 - 55.66 DT, 55.66S - 55.66S DT, 55.86F - 55.86F DT, 55.86S V - 55.86S V DT, 55.86V - 55.86V DT, 56.66S - 56.66S DT, 60.56 - 60.56DT, 60.66S - 60.66S DT, 60.86F - 60.86F DT, 60.86S V - 60.86S V DT, 60.86V - 60.86V DT, 60.93 - 60.93DT, 60.94 - 60.94DT, 62.86F - 62.86F DT, 65.56 - 65.56DT, 65.66S - 65.66S DT, 65.90 - 65.90DT, 65.93 - 65.93DT, 65.94 - 65.94DT, 70.56 - 70.56DT, 70.66S - 70.66S DT, 70.86S V - 70.86S V DT, 70.86V - 70.86V DT, 70.90 - 70.90DT, 72.86F - 72.86F DT, 72.86LP - 72.86LP DT, 72.93 - 72.93DT, 72.94 - 72.94DT, 80.66S - 80.66S DT, 80.90 - 80.90DT, 82.86LP - 82.86LP DT, 82.93 - 82.93DT, 82.94 - 82.94DT, 85.90 - 85.90DT, 88.93 - 88.93DT, 88.94 - 88.94DT, F100 - F100DT, F110 - F110DT, F115 - F115DT, F120 - F120DT, F130 - F130DT, F140 - F140DT, TK100.55, TK55.85F, TK55.85M, TK55.85V, TK60.85F, TK60.85V, TK62.85, TK62.85M, TK75.85, TK75.85M, TK82.85M, TK88.85M	98497117	
10145		MAJOR, POWER MAJOR, SUPER MAJOR, TRADER 590E, TRADER 592E	81411996, 81711727, 81711728, 82847510, E1ADKN8501A, E1ADKN8501B, E1ADKN8501C	
29705		3010S, 3435, 3830, 3935, 4030, 4135, 4230, 4430, 4635, 4835, 5635, 6635, 7635, 8430	99454833	
36197	FORD	2000, 2100, 2110, 2120, 2150, 2190, 2300, 231, 2310, 233, 2600, 2610, 2810, 2910, 3000, 3100, 3120, 3150, 3190, 3230, 3300, 3310, 333, 335, 3400, 3430, 3500, 3600, 3610, 3900, 3930, 4000, 4100, 4110, 4130, 4140, 4190, 420, 4200, 4400, 4450, 4500, 4550, 4600, 4610, 4630, 4830 (<10/88), 5000, 5030 (<10/88), 5110 (<10/88), 5600, 5610 (<10/88), 5700, 5900 (<10/88), 6550, 655D, 6600, 6610 (<10/88), 6700, 6710 (<10/88), 7000, 7100, 7550, 7600, 7700, 7710 (<10/88)	81814205, 81838685, 81863898, 82845215, 83905629, 83912465, 83914023, 83914192, 83919542, 83919560, 83926000, 83926002, 83943914, EAPN8A513F	
40527		DEXTA, SUPER DEXTA	81718104, 957E8501B	
41897		5110 (>11/88), 5610 (>11/88), 6410 (WITH VISCOUS FANS), 6610 (>11/88), 6710 (>11/88), 6810 (>11/88), 7610 (>11/88), 7710 (>11/88)	81863830, 81872289, 83964037, 83964046, 87800123, E7NN8501FB, E7NN8501FE, EJPN8A513FB, FAPN8A513AA	
42999		3010S, 3435 (<C3540), 3830, 3935 (<C3540), 4010S, 4030, 4135 (<C3540), 4230, 4430, 5010S, 8430	98497117	

Art./Ref.	Brand	Applicazione/Application	Rif. Orig./Orig. Ref.	Immagine/Image
93260	JOHN DEERE	1350, 1550, 1750, 1850, 1850N	AR92418, RE26955, RE40151, RE46238, RE546935, RE60489	
93261		4045T, 5715, 5720, 6068H, 6068T, 6110	6005021652, 6005022518, 6005025985, 6005028749, 6005028988, RE500734, RE500737, RE505980, RE505981, RE508566	
10150	LANDINI	6500, 6530F, 6530L, 6550, 6560F, 6560L, 6560V, 6830, 6830V, 6840, 6860, 6860V, 6870, 6880, 6880VM, 7000 SPECIAL, 7500, 7505, 7530F, 7530L, 7550, 7560F, 7560L, 7830, 7860, 7860HC, 7870, 7880, 7880VM, 8500, 8530F, 8530L, 8550, 8560F, 8560L, 8830, 8860, 8860HC, 8870, 8880, 8880HC, ADVANTAGE 65F - 65FP - 65GE, ADVANTAGE 65GT - 65GTP - 65L, ADVANTAGE 65LP - 75F - 75FP, ADVANTAGE 75GE - 75GT - 75GTP, ADVANTAGE 75L - 75LP - 85F, ADVANTAGE 85FP - 85GE - 85GT, ADVANTAGE 85GTP - 85L - 85LP, BLIZZARD :85, BLIZZARD:65, BLIZZARD:75, CINGOLATI :C6500, CINGOLATI :C6830, CINGOLATI :C7800, CINGOLATI :C7830, CINGOLATI :C8860, CINGOLATI: CF 6830, TREKKER 65F - 70F - 75F - 85F, TREKKER :C75, TREKKER :C85, TREKKER :CF75, TREKKER :CF85, TREKKER NG 80F, VIGNETI CAB E F.S.: 75V, VIGNETI CAB E F.S.:65V, VIGNETI FOOTSTEP 65V - 75V	4131A008, 4131A011, 4131A013, 4131A021, 4131A025, 4131A027, 4131A029, 4131A032, 4131A034	
10151		10000, 9500	41312681, 41312703, 41312749, 41312806, 41312807, 41313075	
10153		10000, 10000S, 12500, 13000, 14500, 16000, 16500, 9500	41313027, 41313058, 41313079	
10159		10000, 9500	3641861M91, 41312557, 41313018, 41313045	
10161		4000S, 4530V, 4560V, 5000DT, 5500, 5530F, 5530L, 5530V, 5560F, 5560L, 5560V, 5830, 5840, 5860, 5870, 6030, 6040, ADVANTAGE 55F - 55FP - 55GE, ADVANTAGE 55GT - 55GTP, ADVANTAGE 55L - 55LP, BLIZZARD:50, CINGOLATI: CF5830, CINGOLATI:C4500, CINGOLATI:C4830, CINGOLATI:C5500, CINGOLATI:C5830, CINGOLATI:CF4830, CINGOLATI:CF5030, CINGOLATI:CF6030, GLOBUS:50, TREKKER 50F - 55F, TREKKER CF55, VIGNETI CAB E FOOT STEP:55V	41312161, 41312214, 41312309, 41312357, 41312488, 41312489, 41312504, 41312505, 41312576, 41312589, 41312591, 41312744, 41312768, 41312783, 41312785, 41312786, 41312874, 41312963, 41312964, 41312966, 41312967, 41313403	
40520		5000DT	41312055, 41312154, 41312494, 41312784	
40522		4000 SPECIAL, 4530V, 4560V, 5000DT, 5500, 5530F, 5530L, 5530V, 5560F, 5560L, 5560V, 5830, 5840, 5860, 5870, ADVANTAGE 55F - 55FP - 55GE, ADVANTAGE 55GT - 55GTP - 55L, ADVANTAGE 55LP - 55V, BLIZZARD 50, C4500, C4830, C5500, C5830, CF4830, CF5030, CF5830, GLOBUS 50, TREKKER 50F - 55F, TREKKER CF55	41312159, 41312416, 41312487, 41312495	
40526		6500, 6505, C6000, PRIMA 6000 - 6000 SPECIAL, PRIMA 7000 SPECIAL	41312965, 41312978, 41313458, 41317006, U5MW0010, U5MW0055, U5MW0061, U5MW0089	

Art./Ref.	Brand	Applicazione/Application	Rif. Orig./Orig. Ref.	Immagine/Image
40527	LANDINI	4530V, 4560V, 5500, 5530F, 5530L, 5530V, 5560F, 5560L, 5560V, 5830, 5840, 5860, 5870, 6030, 6040, ADVANTAGE 55F - 55FP - 55GE, ADVANTAGE 55GT - 55GTP, ADVANTAGE 55L - 55LP, BLIZZARD 50, C4500, C4830, C5500, C5830, C6030F, CF4830, CF5030, CF5830, GLOBUS 50, PRIMA 3000R - 3000RV, PRIMA 4000 SPECIAL, PRIMA 5000DT - 5000R-N, PRIMA 5000R-S - 5000 SPECIAL, TREKKER 50F - 55F, TREKKER CF55, VIGNETI 55V, VIGNETI FOOTSTEP 55V	U5MW0057, U5MW0096	
40530		9060, 9080 - 9080HC, 9880 - 9880HC, ADVANTAGE L95GT, BLIZZARD 95, TREKKER C95	41313218, 41313227, 41313237, 41313243, 41313245, 41313252, 41313261	
93264		9060, 9080, 9880, BLIZZARD:95, TREKKER:C95	U5MW0108	

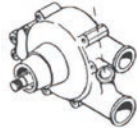
05686	LAVERDA	3300 - 3300R, 3400, 3500 - 3500R, 3550 - 3550R - 3550AL, 3650 - 3650R, 3750 - 3750R	4813370	
05687		3350, 3450, 3600, M112	93191101	
10154		3900	4764156	
10155		MX 240, MX 240 R	4606023	
10156		MX 300, MX 300 R	4710552	
10157		3700, 3790, 3790 R	4796537	
10158		M 150, M 152	8829779	
10159		M120, M132	41313045	

Art./Ref.	Brand	Applicazione/Application	Rif. Orig./Orig. Ref.	Immagine/Image
10160	LAVERDA	M 120, M 132	41313047	
29705		3550AL - 3560AL, L518 - L520	99454833	
42999		3550AL, L517	98497117	
10150	MASSEY FERGUSON	165, 168, 168F, 168S, 174, 174C, 174F, 174S, 174V, 175, 175S, 178, 184, 184F, 184S, 185, 188, 194, 194C, 194F, 194S, 255, 265, 273, 274, 274C, 274CF, 274S, 274SK, 275, 275E, 283, 284, 284S, 285, 290, 290E, 293, 294, 294C, 294S, 3220AP, 3220FP, 3220GE, 3220SP, 3225AP, 3225FP, 3225GE, 3225SP, 3235FP, 3235GE, 3235SP, 362, 362N, 367CF, 372N, 373, 373LX, 373S, 374AP, 374AQ, 374F, 374FP, 374FQ, 374H, 374S, 374SP, 374SQ, 374V, 374VQ, 375E, 376C, 376CF, 376XCF, 377, 382N, 383, 383LX, 383S, 384AP, 384AQ, 384F, 384FP, 384FQ, 384GE, 384S, 384SP, 384SQ, 384V, 384VQ, 387, 390E, 393, 393LX, 393S, 394AP, 394AQ, 394C, 394F, 394FP, 394FQ, 394GE, 394H, 394S, 394SP, 394SQ, 396C, 396CF, 396CT, 397, 565, 575, 590, 675, 690	3637411M91, 3640565M91, 3641219M91, 3641832M91, 4131A008, 4131A011, 4131A013, 4131A021, 4131A025, 4131A027, 4131A029, 4131A032, 4131A034	
10151		1014, 1100, 1104, 1105, 1135, 1200	3641365M91, 41312681, 41312703, 41312749, 41312806, 41312807, 41313075, 4222123M91, 4224118M91, 747611M91	
10152		1004, 1080, 1085, 298, 592, 595, 698	3641364M91, 3641887M91, 41312419, 41312747, 41312828, 41313269, 747446M91	
10153		1014, 1024, 1114, 1134, 2620, 2625, 2640, 2645, 2680, 2685, 2720, 2725, 3080, 3090, 3610, 3630, 3650, 399, 699	3641355M91, 3641859M91, 3641880M91, 41313027, 41313058, 41313079	
10159		500, 507, 510, 515, 520, 525	3641310M91, 3641310R91, 3641861M91, 41312557, 41313018, 41313045	
10160		1250, 24 - 27 - 29 - 29XP, 31 - 31XP -, 530 - 530S, 535, 750, 800 - 805 - 810 - 815	3637466M91, 3638990M91, 3638994M91, 3641314M91, 3641886M91, 41313010, 41313025, 41313033, 41313047, 41313049, 41313059, 41313062, 41313065, 747570M91	
10161		133, 134C, 134V, 135, 135V, 140, 145, 145S, 145V, 148, 150, 152, 152F, 152S, 152V, 154, 154C, 154F, 154S, 154V, 164TF, 164TS, 164TV, 2205, 230, 233, 234C, 234CF, 234S, 235, 240, 244CF, 245, 250, 250X - 250X ADVANCED, 253, 254, 254C, 254CF, 254S, 255, 263T, 264T, 264TCF, 264TS, 3210FP, 3210GE, 3210SP, 333, 334V, 340, 342, 35, 350, 352, 353, 353LX, 353S, 354AP, 354AQ, 354F, 354FP, 354FQ, 354GE, 354S, 354SP, 354SQ, 354V, 354VQ, 355, 356CF, 360, 415, 550	3641338M91, 3641823M91, 41312161, 41312214, 41312309, 41312357, 41312488, 41312489, 41312504, 41312505, 41312576, 41312589, 41312591, 41312744, 41312768, 41312783, 41312785, 41312786, 41312874, 41312963, 41312964, 41312966, 41312967, 41313403, 747542M91	

Art./Ref.	Brand	Applicazione/Application	Rif. Orig./Orig. Ref.	Immagine/Image
40517	MASSEY FERGUSON	135, 35, 835, FE35, TEA20, TED20, TEF20, TEH20	1810369M91, 1881805M91, 1885489M92, 825843M91, 826119M91, 830862M91	
40520		135, 140, 145, 145S, 145V, 203, 205, 2135, 35	41312055, 41312154, 41312494, 41312784	
40522		133, 134C, 134V, 135, 135V, 145, 145S, 145V, 148, 150, 152, 152F, 152S, 152V, 154, 154C, 154F, 154S, 154V, 164TF, 164TS, 164TV, 2205, 230, 233, 234C, 234CF, 234S, 235, 240, 244CF, 245, 250, 253, 254, 254C, 254CF, 254S, 255, 263T, 264T, 264TCF, 264TS, 3210FP, 3210GE, 3210SP, 333, 334V, 340, 342, 350, 352, 353, 353LX, 353S, 354AP, 354AQ, 354F, 354FP, 354FQ, 354GE, 354S, 354SP, 354SQ, 354V, 354VQ, 355, 356CF, 360, 550	41312159, 41312416, 41312487, 41312495	
40526		155, 158, 158F, 158S, 158V, 165, 260, 560, 65, 765, 865	3637372M91, 3641250M91, 41312965, 41312978, 41313458, 41317006, U5MW0010, U5MW0055, U5MW0061, U5MW0089	
40530		1004T, 1007, 3050, 3055, 3060, 3065, 3065S, 3070, 3075, 365, 375, 390 - 390T, 393TLX, 394TAQ, 396CT, 397T, 398, 4225 - 4225HV, 4235 - 4235HV, 4240, 4245 - 4245HV, 4255 - 4255HV, 5275, 5285, 5290, 5300, 5310, 6110, 6120, 6130, 6140, 6150, 698T	3637468M91, 3638998M91, 3638999M91, 3641035M91, 3641263M91, 41313218, 41313227, 41313237, 41313243, 41313245, 41313252, 41313261, 4222002M91	
40532		285, 298	3641363M91	
40543		29 - 29XP - 31 - 31XP, 560, 565, 660, 665, 750, 760, 820, 825, 830, 835, 840, 845, 850, 855, 860	3637467M91, 41313048, 4222001M91	
93263		3640, 399, 560, 6845, 8110	3243C001, 3243C002, 4131E002, 4131E004, 4131E005, 4131E006, 4131E007, 4131E011, 4131E012, 4131E015, 4131E019, 4131E025, 4131E103, 4223566M91, U5MW0065, U5MW0092, U5MW0144, U5MW0151, U5MW0157, U5MW0159, U7LW0071, U7LW0149	
93264	385, 390, 398, 3050	02101379, 293515A1, 3637468M91, 41313218, 41313227, 41313278, 422002M91, 743166M91, U5MW0108		
29705	NEW HOLLAND	L60, L65, L75, L85, L95, TD55D - 7TD65D - 7D75D, TD85D - 7TD95D, TK100.55, TK55.85F, TK55.85M, TK55.85V, TK60.85F, TK60.85V, TK62.85, TK62.85M, TK65F, TK65V, TK72.85, TK72.85M, TK75F, TK75M, TK75V, TK76, TK76M, TK82.85M, TK85, TK85M, TK88.85M, TK95M, TL65 - TL70 - TL80, TL90 - TL100, TN55 - TN65 - TN70 - TN75, TN55D - TN65D - TN70D - TN75D, TN55S - TN65S - TN70S - TN75S, TN55V - TN65V - TN75V, TN60VA - TN95VA, TN65F - TN70F - TN75F, TN65N, TN75N, TN80F - TN90F - TN95F, TN95NA	99454833	

Art./Ref.	Brand	Applicazione/Application	Rif. Orig./Orig. Ref.	Immagine/Image
10150	PERKINS	A4.212, A4.236, A4.248, AT4.236, T4.236	4131A008, 4131A011, 4131A013, 4131A021, 4131A025, 4131A027, 4131A029, 4131A032, 4131A034, U5MW0064, U5MW0104, U7LW0032, U7LW0054, U7LW0068, U7LW0085, U7LW0100	
10151		A6.354, A6.354.1, A6.354.4, AT6.354, AT6.354.1	41312681, 41312703, 41312749, 41312806, 41312807, 41313075, U5MW0018, U5MW0183	
10152		A4.318, A4.318.2	41312419, 41312747, 41312828, 41313269, U5MW0014, U5MW0147	
10153		A6.354.1, A6.354.4, AT6.354.4	41313027, 41313058, 41313079, U5MW0133	
10159		MOTORI 6.354 E 6.372	41312557, 41313018, 41313045, U5MW0111	
10160		A6.354.4, AT6.354.4	41313010, 41313025, 41313033, 41313047, 41313049, 41313059, 41313062, 41313065, U5MW0129	
10161		A3.144, A3.152, AD3.152, AG3.152, AT3.152.4	41312161, 41312214, 41312309, 41312357, 41312488, 41312489, 41312504, 41312505, 41312576, 41312589, 41312591, 41312744, 41312768, 41312783, 41312785, 41312786, 41312874, 41312963, 41312964, 41312966, 41312967, 41313403, U5MW0023, U5MW0097	
40520		A3.144, A3.152, AD3.152	41312055, 41312154, 41312494, 41312784	
40522		A3.144, AD3.152, AG3.152, AT3.152.4, AT4.236	41312159, 41312416, 41312487, 41312495	
40526		A4.192, A4.203, A4.236, AD4.203	41312965, 41312978, 41313458, 41317006, U5MW0010, U5MW0055, U5MW0061, U5MW0089	

Art./Ref.	Brand	Applicazione/Application	Rif. Orig./Orig. Ref.	Immagine/Image
40527	PERKINS	APPLICAZIONI DIVERSE AGRICOLE, APPLICAZIONI DIVERSE INDUSTRIA	U5MW0057, U5MW0096	
40530		A4.236, A4.248, AT4.236, T4.236	41313218, 41313227, 41313237, 41313243, 41313245, 41313252, 41313261, UMSW0095, UMSW0105, UMSW0108	
40532		A4.318, A4.318.2	41313272, U5MW0009	
40543		AT6.354.4	41313048, U5MW00132	
93263		AS 950 (PHASER 90-160T)	3637249M91, 3638694M91, 3641860M91, 4131E011, 4131E101, 4131E105, 41331E103, 4222028M91, 4222028R91, U5MW0092, U5MW0160	
93264		ADVANTAGE CAB:L95	U5MW0108	
<b>ORIGINALI</b> PKU5MW0088			U5MW0088	
<b>ORIGINALI</b> PKU5MW0182			U5MW0182	

**POMPE ACQUA ALTA QUALITA'**

POMPES À EAU HAUTE QUALITÉ  
 WATER PUMPS HIGH QUALITY  
 WASSERPUMPEN HOHER QUALITÄT  
 BOMBAS DE AGUA DE ALTA CALIDAD

**Note:** complete di guarnizioni.

**Notes:** water pumps high quality complete with seals

Art./Ref.	Descrizione estesa/Extended Description	Note/Notes	Immagine/Image
05686TOP	Pompa acqua adattabile al rif. Fiat 4813370 ad alta qualità	Riferimenti originali e applicazioni vedere codice ama 05686/ Original references and applications watch ama code 05686	
05687TOP	Pompa acqua adattabile al rif. Fiat 4679242 ad alta qualità	Riferimenti originali e applicazioni vedere codice ama 05687/ Original references and applications see ama code 05687	

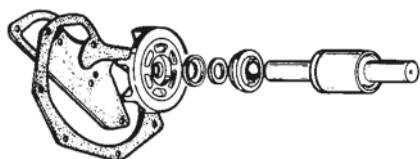

Art./Ref.	Descrizione estesa/Extended Description	Note/Notes	Immagine/Image
<b>10150TOP</b>	Pompa acqua adattabile al rif. Perkins U5MW0104 ad alta qualità	Riferimenti originali e applicazioni vedere codice ama 10150/ Original references and applications see ama code 10150	
<b>10161TOP</b>	Pompa acqua adattabile al rif. Perkins U5MW0097 ad alta qualità	Riferimenti originali e applicazioni vedere codice ama 10161/ Original references and applications see ama code 10161	
<b>29705TOP</b>	Pompa acqua adattabile al rif. Fiat 99454833 ad alta qualità	Riferimenti originali e applicazioni vedere codice ama 29705/ Original references and applications see ama code 29705	
<b>42999TOP</b>	Pompa acqua adattabile al rif. Fiat 98497117 ad alta qualità	Riferimenti originali e applicazioni vedere codice ama 42999/ Original references and applications see ama code 42999	
<b>10136TOP</b>	Pompa acqua adattabile al rif. Fiat 1930925 ad alta qualità	Riferimenti originali e applicazioni vedere codice ama 10136/ Original references and applications watch ama code 10136	
<b>10159TOP</b>	Pompa acqua adattabile al rif. Laverda 41313045 ad alta qualità	Riferimenti originali e applicazioni vedere codice ama 10159/ Original references and applications watch ama code 10159	
<b>36197TOP</b>	Pompa acqua adattabile al rif. CNH 82845215 ad alta qualità	Riferimenti originali e applicazioni vedere codice ama 36197/ Original references and applications watch ama code 36197	
<b>40522TOP</b>	Pompa acqua adattabile al rif. orig. Landini 3641823M91 ad alta qualità	Riferimenti originali e applicazioni vedere codice ama 40522/ Original references and applications watch ama code 40522	
<b>40526TOP</b>	Pompa acqua adattabile al rif. orig. Landini 3641250M91 ad alta qualità	Riferimenti originali e applicazioni vedere codice ama 40526/ Original references and applications watch ama code 40526	
<b>40530TOP</b>	Pompa acqua adattabile al rif. orig. Landini 3637468M91 ad alta qualità	Riferimenti originali e applicazioni vedere codice ama 40530/ Original references and applications watch ama code 40530	

**KIT RIPARAZIONE POMPA ACQUA ADATTABILE**
*REPARATION KIT PUR POMPES À EAU ADAPTABLE*
*WATER PUMP REPAIR KIT ADAPTABLE*
*WASSERPUMPEN REPARTURSATZ PASSEND ZU*
*KIT DE REPARACIÓN POR BOMBAS DE AGUA ADAPTABLE*

Art./Ref.	Brand	Applicazione/Application	Rif. Orig./Orig. Ref.
<b>14199</b>	<b>FIAT</b>	580R, 780R, 855C	1909627, 1940104
<b>41892</b>	<b>FORD</b>	2310, 2600, 2610, 2810, 2910, 3600, 3610, 3900, 4100, 4110, 4600, 4610, 5600, 5700, 6600, 5110 (<10/88), 5610 (<10/88), 555C, 655C, 555D, 575D, 655D, 555E, 575E, 655E, 675D, 675E, 5900 (<10/88), 6610 (<10/88), 6700, 7600, 7700, 6710 (<10/88), 7610 (<10/88), 7710 (<10/88)	81863952, 83923679, 83926012, 83949170, 83956725, 83965725, EAPN8591D, EFPN8591BA, EGN8591CA

Art./Ref.	Brand	Applicazione/Application	Rif. Orig./Orig. Ref.
41947	FORD	5640, 6640, 66400, 7740, 77400, 7840, 8240, 8340	81866491, FBPN8591B
41945		5640, 6640, 66400, 7740, 77400	81866488, FBPN8591A
41866		DEXTA, SUPER DEXTA	81717184, 81844417, E158Z9, E2169T9
41896		5110 (>11/88), 5610 (>11/88), 5610S, 6410, 6610S, 6810, 5900 (>11/88), 6610 (>11/88), 6710 (>11/88), 7610 (>11/88), 6810S, 7010, 7610S, 7710 (>11/88)	81863983, 83964036, EJPN8591EB, FAPN8591DD
41935		5110 (>11/88), 5610 (>11/88), 5900 (>11/88), 6610 (>11/88), 6410 (WITH VISCOUS FANS), 6710 (>11/88), 7610 (>11/88), 7710 (>11/88)	81864001, 83964035, EJPN8591FB, FAPN8591GG
41957		7810, 78100, 7910, 8210, 8530, 8630, 8730, 8830, TW5, TW15, TW25, TW35	83961311, EJPN8591AA
40525	LANDINI	6000, 6000 SPECIAL, 6500, 6505, 7000 SPECIAL, C6000	59140, 59652, 89024, U7LW0027, U7LW0045, U7LW0076, U7LW0092, U7LW0101
40539	LANDINI MASSEY FERGUSON	9500, 10000, 10000S, 1014, 1100, 1104, 1105, 1130, 1135, 1200	89007, U7LW0024, U7LW0123, 3641382M91, 748164M91, 89007, U7LW0024, U7LW0123
40548		6500, 6505, C6000, 6000, 6000SPEC., 7000SPEC., 155, 158, 165, 260, 65, 560, 765, 865, 158F - 158S - 158V, 560, 65, 765, 155, 158, 165, 260	59140, 59652, 89024, U7LW0027, U7LW0045, U7LW0076, U7LW0092, U7LW0101, 3637615M91, 3639521M1, 3640324M91, 3641351M91, 3641393M91, 59140, 59652, 732591M91, 741657M91, 89024, U7LW0027, U7LW0045, U7LW0076, U7LW0092, U7LW0101
40523	MASSEY FERGUSON	122, 25, 30, 130, 825	748709M91, 89020, 89029, 89030, U7LW0003
40541		1250	3637480M91, 3640328M91, 3641332M91, 68572, 68576, 68584, 747891M91, U7LW0060, U7LW0080, U7LW0097
40534		APPLICAZIONI VARIE	59093

### KIT GUARNIZIONI PER POMPE ACQUA

SEALS KIT POUR POMPES A' EAU

GASKET KIT FOR WATER PUMP

SEALS KIT FÜR WASSERPUMPEN

KIT DE JUNTAS PARA BOMBAS DE AGUA

Art./Ref.	Descrizione estesa/Extended Description
85602	Kit guarnizioni per pompe acqua codice AMA 05686 e 05686TOP (adattabile FIAT rif. orig. 4813370)
85601	Kit guarnizioni per pompe acqua codice AMA 05687 e 05687TOP (adattabile FIAT rif. orig. 4679242)
91311	Kit guarnizioni per pompe acqua codice AMA 10136 e 10136TOP (adattabile FIAT rif. orig. 1930925)
85605	Kit guarnizioni per pompe acqua codice AMA 10150 e 10150TOP (adattabile LANDINI rif. orig. U5MW0104)
91312	Kit guarnizioni per pompe acqua codice AMA 10159 e 10159TOP (adattabile Perkins rif. orig. 41313045)
85606	Kit guarnizioni per pompe acqua codice AMA 10161 e 10161TOP (adattabile LANDINI rif. orig. U5MW0097)
85604	Kit guarnizioni per pompe acqua codice AMA 29705 e 29705TOP (adattabile FIAT rif. orig. 99454833)
91313	Kit guarnizioni per pompe acqua codice AMA 36197 e 36197TOP (adattabile FIAT rif. orig. 82845215)
91315	Kit guarnizioni per pompe acqua codice AMA 40526 e 40526TOP (adattabile Landini rif. orig. 3641250M91)
91316	Kit guarnizioni per pompe acqua codice AMA 40530 e 40530TOP (adattabile Landini rif. orig. 3637468M91)
85603	Kit guarnizioni per pompe acqua codice AMA 42999 e 42999TOP (adattabile FIAT rif. orig. 98497117)





### GUARNIZIONI POMPE ACQUA ADATTABILI

SEALS EAU POMPES ADAPTABLE

SEALS WATER PUMPS ADAPTABLE

SEALS WASSERPUMPEN PASSEND ZU

SELLOS DE AGUA BOMBAS ADAPTABLE

Art./Ref.	Brand	Applicazione/Application	Rif. Orig./Orig. Ref.	Immagine/Image
12970	BRAUD	1620 - 1620S	4848840	
14190		1620, SERIE SB	98418621	

Art./Ref.	Brand	Applicazione/Application	Rif. Orig./Orig. Ref.	Immagine/Image
14606	BRAUD	1620 - 1620S, SERIE SB	98400776	
16809		SB65	14457780	
29507		SB52 - SB54	14457880	
12970	FIAT	100.90 - 100.90 DT, 110.90 - 110.90 DT, 115.90 - 115.90 DT, 130.90 - 130.90 DT, 140.90 - 140.90 DT, 45.66 - 45.66 DT, 45.76 V, 50.66 - 50.66 DT, 50.86 V - 50.86 V DT, 50.86S V DT - 50.86S V DT, 55.56 - 55.56 DT, 55.66 - 55.66 DT, 55.75 F-M-V, 55.76 F - 55.76 F DT, 55.76 V - 55.76 V DT, 55.86 F - 55.86 F DT, 55.86 V DT - 55.86 V DT, 55.86S V DT - 55.86S V DT, 55.88 - 55.88 DT, 55.90 - 55.90 DT, 60.56 DT, 60.66 - 60.66 DT, 60.66 F - 60.66 F DT, 60.66 LP - 60.66 LP DT, 60.75 M-V, 60.76 F - 60.76 F DT, 60.86 F - 60.86 F DT, 60.86 V DT, 60.86S V DT - 60.86S V DT, 60.88 - 60.88 DT, 60.90 - 60.90 DT, 62.86 F - 62.86 F DT, 65.56 - 65.56 DT, 65.66 - 65.66 DT, 65.88 - 65.88 DT, 65.90 - 65.90 DT, 70.56 - 70.56 DT, 70.66 - 70.66 DT, 70.66 F - 70.66 F DT, 70.66 LP - 70.66 LP DT, 70.66 V, 70.75 M, 70.76 F - 70.76 F DT, 70.76 LP - 70.76 LP DT, 70.76 V, 70.86 V - 70.86 V DT, 70.86S V DT - 70.86S V DT, 70.88 - 70.88 DT, 70.90 - 70.90 DT, 72.86 F - 72.86 F DT, 72.86 LP - 72.86 LP DT, 80.66 - 80.66 DT, 80.75, 80.76 F - 80.76 F DT, 80.88 - 80.88 DT, 80.90 - 80.90 DT, 82.86 F - 82.86 F DT, 82.86 LP - 82.86 LP DT, 85.90 - 85.90 DT, 90.90 - 90.90 DT	14462882, 4770435, 4848840	
14053		100.55, 100.90, 110.90, 115.90, 130.90, 140.90, 45.66, 50.66, 250, 350, 300, 420, 450, 466, 480, 500, 540, 480S, 500S, 540S, 605C-S, 55.46, 55.56, 55.66, 566, 580, 640, 780, 766, 880/S, 680, 880S, 1000S, 980, 1000, 1180, 1280, 1380	4673810	
14190		100.55C, 100.90, 100.90DT, 1000, 1000S, 110.90, 110.90DT, 115.90, 1180, 1280, 130.90, 1380, 140.90, 250, 300, 350, 420, 45.66, 450, 466, 480, 480S, 500S, 540S, 605C-S, 50.66, 50.66S, 500, 540, 55.46, 55.56, 55.66, 566, 580, 60.66S, 60.90, 640, 680, 70.66S, 766, 780, 80.66, 80.90, 880S, 980, F100, F115, F120, F130, F140	4599562, 4852556, 4854716, 98418621	
14606		100.90 - 100.90DT, 1000S, 880S, 980, 1180, 1280, 110.90 - 110.90DT, 1380, 140.90 - 140.90DT, 250, 300, 350, 420, 480S, 500S, 540S, 605C-S, 50.66 - 50.66DT, 55.56 - 55.56DT, 55.66 - 55.66DT, 55.88 - 55.88DT, 55.90 - 55.90DT, 60.56 - 60.56DT, 60.66 - 60.66DT, 60.88 - 60.88DT, 60.90 - 60.90DT, 60.93 - 60.93DT, 60.94 - 60.94DT, 640, 580, 680, 780, 65.56 - 65.56DT, 65.66 - 65.66DT, 65.88 - 65.88DT, 65.90 - 65.90DT, 65.93 - 65.93DT, 65.94 - 65.94DT, 70.56 - 70.56DT, 70.66 - 70.66DT, 70.66S - 70.66S DT, 70.88 - 70.88DT, 70.90 - 70.90DT, 72.93 - 72.93DT, 72.94 - 72.94DT, 80.66 - 80.66DT, 80.66S - 80.66S DT, 80.88 - 80.88DT, 80.90 - 80.90DT, 82.93 - 82.93DT, 82.94 - 82.94DT, 85.90 - 85.90DT, 88.93 - 88.93DT, 88.94 - 88.94DT, 90.90 - 90.90DT, F100, F115, F120, F130, F140, F110 - F110DT	4599561, 4858073, 98400776	
16809		55.66 DT, 60.93 DT - 60.94 DT, 65.93 DT - 65.94 DT, 72.93 DT - 72.94 DT, 82.93 DT - 82.94 DT, 88.93 DT - 88.94 DT	14457780, 5135740, 583198	
29507		100.55, 100.90 - 100.90 DT, 110.90 - 110.90 DT, 140.90 - 140.90 DT, 45.66 - 45.66 DT, 45.76 V, 50.66 - 50.66 DT, 55.56 - 55.56 DT, 55.65 F-M-V, 55.66 - 55.66 DT, 55.75 F-M-V, 55.76F - 55.76F DT, 55.76V - 55.76V DT, 55.85 F-M-V, 55.88 - 55.88 DT, 60.56 DT, 60.65 M-V, 60.66 - 60.66 DT, 60.75 M-V, 60.76F - 60.76F DT, 60.85 F-V, 60.88 - 60.88 DT, 60.93 - 60.93 DT, 60.94 - 60.94 DT, 62.85 M, 65.56 - 65.56 DT, 65.66 - 65.66 DT, 65.88 - 65.88 DT, 65.90 - 65.90 DT, 65.93 - 65.93 DT, 65.94 - 65.94 DT, 70.56 - 70.56 DT, 70.65 M, 70.66 - 70.66 DT, 70.75 M, 70.76 LP - 70.76 LP DT, 70.76 V, 70.76F - 70.76F DT, 70.88 - 70.88 DT, 70.90 - 70.90 DT, 72.85 M, 72.93 - 72.93 DT, 72.94 - 72.94 DT, 80.65, 80.66 - 80.66 DT, 80.75, 80.76F - 80.76F DT, 80.88 - 80.88 DT, 80.98 - 80.98 DT, 82.85 M, 82.93 - 82.93 DT, 82.94 - 82.94 DT, 85.55, 85.98 - 85.90 DT, 88.85 M, 88.93 - 88.93 DT, 88.94 - 88.94 DT, 90.90 - 90.90 DT, 95.55, F100 - F100 DT, F110 - F110 DT, F115 - F115 DT, F120 - F120 DT, F130 - F130 DT, F140 - F140 DT	14457880, 350358153, 44004518, 79040133, 98458443	

Art./Ref.	Brand	Applicazione/Application	Rif. Orig./Orig. Ref.	Immagine/Image
12970	FORD	3830 - 4030 - 4230 - 4430	4848840	
14190		3010S, 3435, 3830, 3935, 4010S, 4030, 4135, 4230, 4430, 4635, 4835, 5010S, 5635, 6635, 7635, 8430	98418621	
14606		3010S, 3435, 3830, 3935, 4010S, 4030, 4135, 4230, 4430, 4635, 4835, 5010S, 5635, 6635, 7635, 8430	98400776	
29507		3010S - 4010S, 4635 - 4835, 5010S, 5635, 6635, 7635, 8430	14457880	
12970	LAVERDA	3300AL, 3400 - 3400R, 3550AL, 3650 - 3650R, 3750 - 3750R	4848840	
14053		3300AL	4673810	
14190		3400,3550,3560,3650,3750,L517	98418621	
14606		3400 - 3400R, 3550AL - 3650AL, 3650 - 3650R, 3750 - 3750R, L517 - L518 - L520	98400776	
16809		3500 - 3550 - 3550AR - 3560AL, L517 - L521, L523 INTEGRALE - L523 MCS, L524, L525 INTEGRALE - L525 MCS, L624 - L625 - L626, L627 INTEGRALE - L627 MCS, TL58 I	14457780	
29507		3400 - 3400R - 3550AL, MX240 - MX240R, MX300 - MX300R	14457880	
14190	NEW HOLLAND	L60, L65, L75, L85, L95, LB75, SERIE, SERIE TN, TNA, TND, TNF, TNS, TNSA, SERIE TNV, TNVA, TELESCOPICO/TELEHANDLER LM, TL70,	98418621	
14606		SERIE L, SERIE TD - TDD - TDF, SERIE TK, SERIE TL, SERIE TT, SERIE-TN, SERIE-TNN, SERIE-TND, SERIE-TNS, SERIE-TNF, SERIE-TNDA, SERIE-TNFA, SERIE-TNNA, SERIE-TNA, SERIE-TNSA, SERIE-TNVA	98400776	
16809		T4020 - T4030 - T4040 - T4050, T6010 - T6020 - T6030 - T6040, T6050 - T6060 - T6070, T7030 - T7040 - T7050 - T7060, TD55D - TD60D, TD65B, TD65D - TD70D - TD75D, TD80D - TD85D - TD90D - TD95D, TL100 - TL100A, TL60 - TL60E - TL65, TL70 - TL70A, TL75 - TL75E, TL80 - TL80A, TL85 - TL85E, TL90 - TL90A, TL95 - TL95E, TN60DA - TN70DA - TN75DA, TN85DA - TN85SA - TN95DA, VL5060 - VL5070, VL5080 - VL5090, VL530 - VL540 - VL550 - VL570, VM3080 - VM3080AL, VM3090, VM340 - VM370, VN2090, VN240 - VN260 - VN300	14457780	





Art./Ref.	Brand	Applicazione/Application	Rif. Orig./Orig. Ref.	Immagine/Image
<b>29507</b>	<b>NEW HOLLAND</b>	L60 - L65 - L75 - L85 - L95, T4020 - T4020V, T4030 - T4030F, T4030N - T4030V, T4040 - T4020F, T4040N - T4040V, T4050 - T4050F, T4050N - T4050V, T5030 - T5040 - T5050, T5060 - T5070, T7.220 - T7.235 - T7.250, T7.260 - T7.270, T7030 - T7040 - T7050, T7060 - T7070, TK100A, TK4020F - TK4020V, TK4030 - TK4030F - TK4030V, TK4040 - TK4040M, TK4050 - TK4050M, TK4060, TK65F - TK65V, TK70FA - TK70VA, TK75F - TK75FA, TK75M - TK75MA, TK75V - TK75VA, TK76 - TK76M, TK80A - TK80MA, TK85 - TK85M, TK90A - TK90MA, TK95M, TL100 - TL100A, TL65 - TL70 - TL70A, TL80 - TL80A - TL90 - TL90A, TM115 - TM120 - TM125, TM130 - TM135 - TM140, TM150 - TM155 - TM165 - TM180, TM7010 - TM7020, TM7030 - TM7040, TN55D - TN55S - TN55V, TN60DA - TN60SA - TN60VA, TN65D - TN65F - TN65N, TN65S - TN65V, TN70D - TN70DA, TN70F - TN70NA, TN70S - TN70SA - TN70VA, TN75D - TN75DA, TN75F - TN75FA, TN75N - TN75NA, TN75S - TN75SA, TN75V - TN75VA, TN80F, TN85DA - TN85FA - TN85SA, TN90F, TN95DA, TN95F - TN95FA, TN95NA - TN95VA	14457880	

**RACCORDI PER POMPE ACQUA ADATTABILI**
*RACCORD POMPE A EAU ADAPTABLE*
*WATER PUMPS CONNECTIONS ADAPTABLE*
*ANSCHLUSS WASSERPUMPE PASSEND ZU*
*RACOR PARA BOMBA DE AGUA ADAPTABLE*

Art./Ref.	Note/Notes	Brand	Applicazione/Application	Rif. Orig./Orig. Ref.	Immagine/Image
<b>16692</b>	Raccordo in plastica adattabile a rif. orig. 98464616/ Plastic pipe for water pump 42999	<b>BRAUD</b>	SERIE SB	98464616	
<b>17700</b>	Raccordo metallico adattabile a rif. orig. Fiat 4859907		1620,1620S	4859907	
<b>19074</b>	Tubo rigido adattabile a rif. orig. Fiat 4762764		1214	4762764	
<b>10485</b>	Tubazione sopra termostato/Upper thermostat pipe	<b>CASE IH</b>	JX1060C, JX1075C, JX1060V, JX1070V, JX1070C, JX1095, JX1070N, JX1075N, JX1095N, JX55, JX60, JX70, JX75, JX90, JX95, JX55T, JX75T	153625832, 4599810, 4661543, 82982280	
<b>14561</b>	Tubo rigido da pompa a manicotto intermedio/ Rigid pipe from pump to intermediate hose		JX100U, JX1060C, JX70U, JX80U, JX90U, JX1075C, JX55, JX60, JX70, JX75, JX80, JX90, JX85	4697838	
<b>08635</b>	Raccordo per 05687/Raccord pour Art. 05687/Fitting for Code 05687/ANSCHLUSS FUER ART. 05687/Racor para art. 05687	<b>FIAT</b>	1000, 1000S, 1180, 1280, 1380, 250, 300, 420, 450, 460, 466, 480, 480S, 500S, 540S, 605C-S, 500, 540, 550, 566, 570, 580, 600, 640, 666, 680, 760, 766, 780, 880-5, 880S, 980	4673807	

Art./Ref.	Note/Notes	Brand	Applicazione/Application	Rif. Orig./Orig. Ref.	Immagine/Image
10485	Tubazione sopra termostato/Tube supérieur pour thermostat/Upper thermostat pipe/ROHR AUF DEM THERMOSTAT/Tuberia sobre el termostato		100.55C, 100.90, 100.90DT, 1000S, 880S, 980, 1180, 1280, 115.90, 115.90DT, 130.90, 130.90DT, 1380, 140.90, 140.90DT, 45.66, 45.66DT, 450, 480, 480S, 50.66, 50.66DT, 500S, 540S, 55.46, 55.46DT, 55.56, 55.56DT, 55.65M, 55.66DT, 55.66DT-F-LP, 55.66S, 55.75M, 55.85M, 55.88DT, 55.90, 55.90DT, 580, 60.46, 60.46DT, 60.65M, 60.66S, 60.75M, 60.86, 60.90, 60.90DT, 60.93, 60.93DT, 60.94, 60.94DT, 605C-S, 62.85M, 62.86F-DT, 640, 65.46DT, 65.56, 65.56DT, 65.66-S-DT, 65.88, 65.88DT, 65.90, 65.90DT, 65.93, 65.94, 666, 680, 70.56, 70.56DT, 70.66, 70.66DT, 70.66S, 70.75M, 70.90, 70.90DT, 72-85M, 72.86F-DT, 72.93, 72.94, 780, 780DT, 80.66, 80.75, 80.88, 80.90, 85.90, 88.93, 88.94, 90.90, 95.55, F100, F110, F115, F120, F130, F140	4599810, 4661543	
12969	Raccordo per 05686//Fitting for code 05686/AN-SCHLUSS FUER 05686/Racor para art. 05686		100.90, 100.90DT, 110.90, 110.90DT, 115.90, 115.90DT, 130.90, 130.90DT, 140.90, 140.90DT, 45.66, 45.66DT, 50.66, 50.66DT, 55.46, 55.46DT, 55.56, 55.56DT, 55.65, 55.66, 55.66DT, 55.66S, 55.75, 55.88, 55.88DT, 55.90, 55.90DT, 60.46, 60.46DT, 60.65M, 60.66, 60.66DT, 60.66S, 60.75, 60.76F, 60.86, 60.86DT, 60.86S, 60.88, 60.88DT, 60.90, 60.90DT, 65.46, 65.46DT, 65.56, 65.56DT, 65.66, 65.66DT, 65.88, 65.88DT, 65.90, 65.90DT, 70.56, 70.56DT, 70.65, 70.65M, 70.66, 70.66DT, 70.66S, 70.75, 70.75M, 70.76, 70.76DT, 70.86S, 70.90, 70.90DT, 80.65, 80.66, 80.66DT, 80.66S, 80.75, 80.76F, 80.88, 80.88DT, 80.90, 80.90DT, 85.55, 85.90, 85.90DT, 90.90, 90.90DT, 95.55	4770247	
14349	-/-/-/-	FIAT	1000S, 480S, 500S, 540S, 605C-S, 500,600,900,1000,480, 55.66F,55.76F,55.86F, 640, 580, 680, 780	4606663, 4614162, 4614165, 4956119	
14561	Tubo rigido da pompa a manicotto intermedio - Rigid pipe from pump to intermediate hose/Tubo rigido da pompa a manicotto intermedio - Rigid pipe from pump to intermediate hose/Rigid pipe from pump to intermediate hose./Tubo rigido da pompa a manicotto intermedio - Rigid pipe from pump to intermediate hose/Tubo rigido da pompa a manicotto intermedio - Rigid pipe from pump to intermediate hose		1000S, 880S, 980, 1180, 1280, 1380, 250, 300, 350, 420, 480, 500S, 540S, 605C-S, 640, 50.66,56.66,60.66,65.66,70.66, 50.86,55.86,60.86,62.86,70.86, 55.46,60.46,65.46, 55.56,60.56,65.56,70.56, 55.65,55.76,60.76,70.76,80.76, 580,, 70.88,80.88,60.93,65.93,72.93, 72.86,82.86,55.88,60.88,65.88, 80.66, 60.90, 80.90, 82.93,88.93,60.94,65.94,72.94, 82.94,88.94, L60,L65,L75,L85,L95	4614160, 4697838	
16692	Raccordo in plastica adattabile a rif. orig. 98464616//Plastic pipe for water pump 42999		45.66, 56.66S, 60.66S, 70.66S, 50.86,55.86,60.86,62.86,70.86, 55.85,60.85,62.86,72.85,82.85, 55.88,60.88,65.88,70.88,80.88, 72.86,82.86, 80.66S, 60.90, 80.90, 88.85,100.55, F100, F115, F120, F130, F140	98464616	
17700	Raccordo metallico adattabile a rif. orig. Fiat 4859907		45.66, 55.66S, 60.66S, 70.66S, 45.76,50.86,70.76,80.76,60.86, 50.66,65.66,80.66,, 55.56,60.56,65.56,70.56, 55.75,60.75,70.75,80.75, 55.85,60.85,100.90,110-90, 60.88,65.88,70.88,80.88, 62.86,82.86,70.86,72.86, 80.66S, 60.90, 80.90, F100, F115, F120, F130, F140	4859907	
19074	Tubo rigido adattabile a rif. orig. Fiat 4762764		115-90,130-90,140-90, F100, F115, F120, F130, F140	4762764	
10485	Tubazione sopra termostato/Upper thermostat pipe	FORD	3435, 3830, 3935, 4010S, 4030, 4135, 4430, 4635, 4835, 5635, 6635, 7635, 5010S	4661543	

Art./Ref.	Note/Notes	Brand	Applicazione/Application	Rif. Orig./Orig. Ref.	Immagine/Image
14349	-	<b>FORD</b>	3830	4614162	
14561	Tubo rigido da pompa a maniccotto intermedio/Rigid pipe from pump to intermediate hose		3010S, 3435, 3830, 3935, 4010S, 4030, 4135, 4230, 4450, 4635, 4835, 5635, 6635, 7635, 8430	4697838	
16692	Raccordo in plastica adattabile a rif. orig. 98464616/ Plastic pipe for water pump 42999		3435 (<C3540), 3935 (<C3540), 4135 (<C3540), 4635, 4835, 5635, 6635, 7635	98464616	
17700	Raccordo metallico adattabile a rif. orig. Fiat 4859907		3435(<D3350) ,3935(<D3350), 3830,4030,4230,4430, 4135(<D3350)	4859907	
42040	Tubazione sopra termostato/ Upper thermostat pipeline		2000, 2310, 2600, 2610, 2810, 2910, 3000, 3055, 3230, 3430, 3930, 4130, 4630, 3600, 3610, 3910, 4000, 4100, 4110, 4600, 4610, 5000, 5600, 5700, 6700, 5110, 5610, 5900, 6410, 6610, 555B, 655, 655A, 6600, 6710, 6810, 7410, 7610, 7710, 7000, 7600, 7700, 8000, 8200, 8600, TW10,TW20,TW30	C7NN 8594A	
08635	Raccordo per 05687/Fitting for Code 05687	<b>LAVERDA</b>	3300AL	4673807	
10485	Tubazione sopra termostato/Upper thermostat pipe		3300,3400,3750,L517,L518,L520, 3500,3550,3560,3650,3750	4661543	
12969	Raccordo per 05686//Fitting for code 05686/AN-SCHLUSS FUER 05686/Racor para art. 05686		3300,3400,3500,3550,3650,3750	4770247	
16692	Raccordo in plastica adattabile a rif. orig. 98464616//Plastic pipe for water pump 42999		3400,3500	98464616	
17700	Raccordo metallico adattabile a rif. orig. Fiat 4859907		3400,3550,L517	4859907	
19074	Tubo rigido adattabile a rif. orig. Fiat 4762764		3300,3400,3500,3550,3650,3750	4762764	
10485	Tubazione sopra termostato/Upper thermostat pipe	<b>NEW HOLLAND</b>	LB75, SERIE, SERIE TD,TDD,TDF,TT, SERIE TNA,TND,TNDA,TNFA,TNNA, SERIE TND,SERIE,TNS,SERIE,TNF, SERIE TNS,TNSA,TNV,TNVA, TELESCOPICO/ TELEHANDLER LM	4661543	
14561	Tubo rigido da pompa a maniccotto intermedio/Rigid pipe from pump to intermediate hose		SERIE TND, SERIE TNS,SERIE TNF, TL70,, TL70,TL80,TL90,TL100	4697838	

Art./Ref.	Note/Notes	Brand	Applicazione/Application	Rif. Orig./Orig. Ref.	Immagine/Image
42040	Tubazione sopra termostato/Upper thermostat pipeline	<b>NEW HOLLAND</b>	L781,L783,L785,L865, LX865,LX885	81817129	
14561	Tubo rigido da pompa a manicotto intermedio/Rigid pipe from pump to intermediate hose	<b>STEYR</b>	KOMPAKT 360,KOMPAKT 370, KOMPAKT 375	4697838	
08635	Raccordo per 05687/Fitting for Code 05687	<b>UNIVERSAL</b>	300,340,445,453,530,533	11511144	
10485	Tubazione sopra termostato/Upper thermostat pipe		300,320,340,350,353,445,453, 500,530,533	11511138	

**PULEGGE PER POMPE ACQUA ADATTABILI**

POULIE POUR POMPES A EAU ADAPTABLE  
 PULLEYS FOR WATER PUMPS ADAPTABLE  
 SCHEIBE FUER WASSERPUMPE PASSEND ZU  
 POLEA PARA BOMBA AGUA ADAPTABLE



Art./Ref.	Brand	Applicazione/Application	Rif. Orig./Orig. Ref.
37021	<b>FIAT - FORD</b>	60.66,80.66,60.76,80.76,55.86, 62.86,72.86,82.86, L60,L65,L75,L85,L95, SERIE DIAMANTE, SERIE ORO, 3435, 3830, 3935, 4030, 4135, 4430	4615467, 4736987, 4655014, E0558005MD15
40319	<b>LANDINI MASSEY FERGUSON</b>	4000S, 5500, 5830, 5840, 5860, 5870, 6030, 6040, 6060, 6070, ADVANTAGE CAB E FOOT STEP:55, ADVANTAGE CAB E FOOT STEP:60, BLIZZARD:50, BLIZZARD:60, CINGOLATI: CF5830, CINGOLATI:C4500, CINGOLATI:C4830, CINGOLATI:C5000, CINGOLATI:C5500, CINGOLATI:C5830, CINGOLATI:CF4830, CINGOLATI:CF5030, CINGOLATI:CF6030, CINGOLATI:CF6060, FRUTTETI 530F/L/V:6030, FRUTTETI 560 F/L/V:4560, FRUTTETI 560 F/L/V:5560, FRUTTETI 560F/L/V:6060, FRUTTETI:530F/L/V:4530, FRUTTETI:530F/L/V:5530, GLOBUS:50, TREKKER:CF55, TREKKER:CF60, VIGNETI CAB E FOOT STEP:55V, VIGNETI CAB E FOOT STEP:60V, 135, 148	31145741
40320		135, 35, 35X	31145631, 731280M1



**RADIATORI IN RAME ADATTABILI**

RADIATEUR CUIVRE ADAPTABLE  
 RADIATOR COPPER ADAPTABLE  
 KÜHLER COPPER PASSEND ZU  
 RADIADOR DE COBRE ADAPTABLE



**Note:** Tutti i modelli sono forniti completi di tappo

**Notes:** All models supplied with plug

Art./Ref.	Brand	Applicazione/Application	Rif. Orig./Orig. Ref.
09591	FIAT	411, 451C	576976
09592		650, 715, 750, FL6	44089044, 4950225, 4951831
16060		45.66-45.66 DT, 45.66S-45.66S DT, 50.66-50.66 DT, 50.66S-50.66S DT, 55.66LP-55.66L DT, 56.66S-56.66S DT, 60.66F-60.66F DT, 60.66LP-60.66LP DT, 60.76F-60.76F DT, 62.86F-62.86F DT	5128854, 5156033
16344		1180, 1280, 1380	5103110, 5109294
16581		311, 312	576975
16583		315, 415, 415R	588156, 595568
85538		60-75 V, 60-85 V, SERIE 76 F - V, SERIE 86 F - V	44908541
16584			4954504, 4977095
N05167369			5167369
16060		FORD	3435-3935-4135, 4030
17092	2000, 2100, 2110, 2120, 2150, 2300, 2310, 2600, 2610, 2810, 2910, 3000, 3055, 3100, 3110, 3120, 3150, 3300, 3310, 3330, 3400, 3500, 3550, 3600, 3610, 3900, 3910, 4000, 4100, 4110, 4140, 4200, 4330, 4340, 4400, 4410, 4500, 4600, 4610, 5000, 5100, 5200, 5340, 5600, 5700, 6600, 7000, 7100, 7200, 7600, 7700		81875325, 87687383, E0558005MD15, E0NN8005MD15M
17093	231-233, 2600-2600N-2600R-2600V, 333-335, 3600-3600N-3600NO-3600R-3600V, 3900-4000-4100-4110-4140-420, 4200-4330-4340-4400-4410-4500, 5100-515-5200-531-532-5340-535, 5600-5700-6600-6600C-66000, 6700-7000-7100-7200, 7600-7600C-7700		81817280
42068	5110, 5610, 6410, 6610-66100, 6710, 6810, 7410, 7610-76100, 7710		83993346, E0NN8005GC15M
85538	4230 - 4430		44908541
85539	4635, 4835, 5635, 6635, 7635		5169275
09595	LANDINI	5500, 5830, 5840, 6500, 6550, 6830, 6840, 7500, 7550, 7830, 8500, 8550, 8830, CINGOLATI :C6830(FINO A 320B01, CINGOLATI:C4500, CINGOLATI:C4830, CINGOLATI:C5500, CINGOLATI:C5830, CINGOLATI:C6500, CINGOLATI:C7800	1824627M91, 1824627M93
71301		5830, 5860, 5870, 6030, 6040, 6060, 6070, 6550, 6830, 6860, 6870, 6880, 7830, 7860, 7870, 7880, 8830, 8860, 8870, 8880, BLIZZARD:50, BLIZZARD:60, BLIZZARD:65, BLIZZARD:75, BLIZZARD:85, CINGOLATI: C6830, CINGOLATI: C7830, CINGOLATI:C8860, CINGOLATI:CF4830, CINGOLATI:CF5030, CINGOLATI:CF5830, CINGOLATI:CF6030, CINGOLATI:CF6060, CINGOLATI:CF6830, FRUTTETI 530 F/L/V:8530F, NEW SERIE 60:5860, TREKKER C:C75, TREKKER C:C85, TREKKER CF:CF65, TREKKER CF:CF75, TREKKER CF:CF85, TREKKER NEW:70C/F/L, TREKKER NEW:80C/F/L	3666234M91
LN3658383M91			3658383M91
09595	MASSEY FERGUSON	134C - 154 - 154C - 174 - 174C, 194 - 194C, 233 - 234C - 234S - 253, 254 - 254C - 254S - 273, 274 - 274C - 274S - 274SK, 283 - 284 - 284S, 293 - 294 - 294S	1824627M91, 1824627M93
11258		165, 50	885411M93, 897357M92, 897358M4
11288		133, 135, 135V, 140, 145, 145S, 145V, 148, 152, 152F, 152S, 152V, 40	1660498M91, 1660499M92, 1871721M91, 885856M94, 962071M93
11289		20B - 20E - 20F, 230, 240, 250, 30E - 30H - 40E	1672862M91, 1680547M91, 1680547M92
40561		35	894319M92
40571		FE35	894357M92
40578		265, 275, 285, 565	1876606M4, 1876607M1
16060		NEW HOLLAND	TK55.65 F - V - M, TK55.75 F - V - M
85539	L60 - L65 - L75 - L85 - L95, TK100A, TK65F - TK65V, TK70FA - TK70VA, TK75F - TK75FA, TK75M - TK75MA, TK75V - TK75VA, TK76 - TK76M, TK80A - TK80MA, TK85 - TK85M, TK90A - TK90MA, TK95M, TL70 - TL80 - TL90 - TL100		5169275, S5169275

**ORIGINALE**

**RADIATORI IN ALLUMINIO**

RADIATEURS EN ALUMINIUM  
ALUMINUM RADIATORS  
ALUMINIUM-KUHLER  
RADIADORES DE ALUMINIO



**Note:** Tutti i modelli sono forniti completi di tappo

**Notes:** All models supplied with plug

Art./Ref.	Note/Notes
<b>09593A</b>	NEW ALUMINUM - TOP QUALITY - RIF ORIGINALI E APPLICAZIONI VEDERE CODICE 09593/NEW ALUMINUM - TOP QUALITY - REF. OEM AND APPLICATIONS SEE CODE 09593
<b>09594A</b>	NEW ALUMINUM - TOP QUALITY - RIF ORIGINALI E APPLICAZIONI VEDERE CODICE 09594/NEW ALUMINUM - TOP QUALITY - REF. OEM AND APPLICATIONS SEE CODE 09594
<b>16576A</b>	NEW ALUMINUM - TOP QUALITY - RIF ORIGINALI E APPLICAZIONI VEDERE CODICE 16576/NEW ALUMINUM - TOP QUALITY - REF. OEM AND APPLICATIONS SEE CODE 16576

**MANICOTTI IN BARRE DA 1 MT.**

MANCHONS EN BARRE DE 1 MT.  
HOSE 1 MT. LONG  
SCHLAUCHEN - LAENGE 1 MT.  
MANGOS EN BARRAS DE 1 MT.

**Note:** Con inserti in tessuto. Temperatura d'impiego da -40° a +120°

**Notes:** With tissue inserts. Usage temperature from -40° to + 120°

Art./Ref.	A mm	B mm	Bar	Note/Notes
<b>52669</b>	16	24	5	Tubo radiatore/Radiator hose
<b>52672</b>	20	27		
<b>52675</b>	22	29		
<b>52678</b>	25	32		
<b>52683</b>	28	36		
<b>52686</b>	32	40		
<b>52688</b>	35	43		
<b>52691</b>	38	48		
<b>52694</b>	45	55		

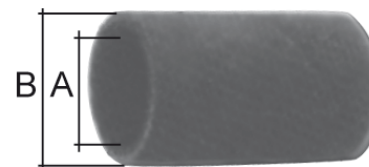

**MANICOTTI SUPERIORI ADATTABILI**

MANCHONS ADAPTABLE

HOSE ADAPTABLE

KUEHLERSCHLAHUELSE PASSEND ZU

MANGOS ADAPTABLE



Art./Ref.	Brand	Applicazione/Application	Rif. Orig./Orig. Ref.
08571	FIAT	100.90-100.90 DT, 110.90-110.90 DT, 55.90-55.90 DT, 580, 60.90-60.90 DT, 65.90-65.90 DT, 65.94-65.94 DT, 680, 70.90-70.90 DT, 72.94-72.94 DT, 780, 80.90-80.90 DT, 82.94-82.94 DT, 85.90-85.90 DT, 88.94-88.94 DT, 880-5, 90.90-90.90 DT, 980	4997263, 5111527
08572		446 - 446 DT, 465, 466 - 466 DT, 55.46-55.46 DT, 55.56-55.56 DT, 55.66-55.66 DT, 566, 570, 60.46-60.46 DT, 60.56-60.56 DT, 60.65M - 60.65V, 60.66-60.66 DT, 65.46-65.46 DT, 65.56-65.56 DT, 65.66-65.66 DT, 666, 670, 70.56-70.56 DT, 70.66-70.66 DT, 766, 80.66-80.66 DT	5104825
08632		450, 450 DT, 480, 480 DT, 500, 500 DT, 540, 540 DT, 540S, 550, 600, 640	4950088
12982		115.90-115.90 DT, 1180, 1180 DT, 1280, 1280 DT, 130.90-130.90 DT, 1380, 1380 DT, 140.90-140.90 DT, 980	5107001
35052		250, 300, 350, 420	597704
36410		55-66, 55-76, 55-86 (V+F), 60/86 (V+F)	44901505, 9955610
35119			5166580
35053			5143791
08568			4955472
08530			10139686
21820	FORD	2000, 2100, 2110, 2120, 2150, 2300, 231 - 233 - 333 - 335 - 420, 2310, 2600, 2610, 2810, 2910, 3000, 3100, 3120, 3150, 3190, 3300, 3400, 3500, 3600, 3610, 3900, 3910, 4000, 4100, 4110, 4130, 4140, 4190, 4200, 4400, 4450, 4500, 4550, 4600, 4610, 5000, 5100, 5110, 5190, 5200, 5550, 5600, 5610, 5900, 6550, 6600, 6610 (=>07.87) CON ARIA COND, 6610 SENZA ARIA COND., 7000, 7100, 7550, 7600, 7610	81805628, 83907414, C5NN8260A, C5NN8260B, D5NN8260D
42147		5110 (>08.87), 5610 (>08.87), 5610S, 5900 (>08.87), 6410, 6610 (>08.87), 6610S, 6810, 6810S, 7010, 7410, 7610 (>08.87), 7610S	83959443, E6NN8260CA
42148		5610, 5700, 5900, 6700, 6710 (<07.87 NO AC), 7700, 7710 (<07.87 NO AC)	83905554, D5NN8260C
42153		6710, 7700, 7710 (<07.87 AC)	83905570, D4NN8260C
42155		7710 C/ARIA COND (08.87=>), 7710 C/ARIA COND (>08.87)	83959442, E6NN8260BA
42158		7840, 8240, 8340	81862935, F0NN8260DA
42159		7910, 8210	83929875, E0NN8260AA
42162		8530, 8630, 8730, 8830, TW5-15-25-35	83933451, 83934898, E2NN8333AA, E3NN8333AA
42163		8700, 9700	83914013, D8NN8260CA
42167		8530 - 8630 - 8730 - 8830, TW30-TW35, TW5-TW10-TW15-TW20-TW25	83913315, 83918850, 83934898, D8NN8260BA, D8NN8260BB
42955	3230, 3430, 3930, 4130, 4630, 4830, 5030	82015118	
08530	7635		
38292	JOHN DEERE	2250, 2355, 2450, 2450F, 2555CS, 2555TSS, 2650, 2650CS, 2650F, 2650N, 2650TSS, 2755, 2850, 2855N	L56296
71014	LANDINI	VIGNETI REX CAB TIER 2:75V, VIGNETI REX CAB TIER 2:85V	3678913M1
40540	MASSEY FERGUSON	3085, 3095, 3115, 3120, 3120T	3582179M1
40596		35	890195M1
40598		133, 135, 135V, 140, 145, 145S, 145V, 148, 152, 152F, 152S, 152V, 20B-20D-20E-20F-30E-30H-40-40E, 230, 235, 240, 245, 253, 255, 263, 263T	1869514M1, 897455M1
40602		340, 342, 350, 352, 355, 360	1696559M1
40605		TEA20, TED20, TEF20, TEH20	1568
40607		FE35	827496M1
40610		65, 765, 865	827930M1
40612		165, 50	194738M1, 898064M1
40614		165, 168 - 168F - 168S, 175S, 178, 185 - 188, 265, 275, 275E, 285, 290, 30D - 50 - 50B, 375E, 575 - 575 - 590	885564M1, 899144M1
40616		175, 178	194739M1, 894793M1
40619		362	3611652M1
40628		675, 690	1681509M1
40629		1004, 298, 698	1669805M1
40633		699	1692871M1
40639		3050, 3060, 3065	3382976M1
40643	3080, 3090	3387747M1	

**MANICOTTI INTERMEDI ADATTABILI**

MANCHONS ADAPTABLE

HOSE ADAPTABLE

KUEHLERSCHLAHUELSE PASSEND ZU

MANGOS ADAPTABLE



Art./Ref.	Brand	Applicazione/Application	Rif. Orig./Orig. Ref.
<b>08626</b>	<b>CASE</b>	AVJ55 - AVJ60 - AVJ70, JX100U-JX1060C-JX1060V, JX1070C-JX1070N-JX1070V, JX1075C-JX1075N-JX1075V, JX1095N-JX1095V, JX55-JX60-JX65-JX70, JX70U-JX75-JX80-JX80U, JX85-JX90-JX90U-JX95, VJ60 - VJ70 - VJ80	596152
<b>08579</b>		750, 850, 880	8819913
<b>08626</b>	<b>FIAT</b>	100.90-100.90DT, 1000, 110.90-110.90 DT, 115.90-115.90 DT, 1180, 130.90-130.90 DT, 140.90-140.90 DT, 35.66-35.66DT, 45.66-45.66DT, 45.66S-45.66S DT, 450, 450R, 450V, 455C, 480, 480V, 50.66-50.66DT, 50.66S-50.66S DT, 500, 500S, 505C, 540, 540V, 55.46-55.46DT, 55.56-55.56DT, 55.66-55.66DT, 55.66LP-55.66LP DT, 55.66S-55.66S DT, 55.88-55.88DT, 55.90-55.90DT, 550, 555C, 56.66S-56.66S DT, 580, 60.46-60.46 DT, 60.56-60.56 DT, 60.66-60.66 DT, 60.66F-60.66F DT, 60.66LP-60.66LP DT, 60.66S-60.66S DT, 60.76F-60.76F DT, 60.88-60.88 DT, 60.90-60.90DT, 60.93-60.93DT, 60.94-60.94 DT, 600, 605C, 62.86F-62.86F DT, 640, 65.46-65.46DT, 65.56-65.56DT, 65.66-65.66DT, 65.66S-65.66S DT, 65.88-65.88DT, 65.90-65.90DT, 65.93-65.93 DT, 65.94-65.94 DT, 680, 70.56-70.56DT, 70.66-70.66DT, 70.66F-70.66F DT, 70.66LP-70.66LP DT, 70.66S-70.66S DT, 70.66V-70.66V DT, 70.76F-70.76F DT, 70.76LP-70.76LP DT, 70.76V-70.76V DT, 70.88-70.88DT, 70.90-70.90DT, 72.86F-72.86F DT, 72.86LP-72.86LP DT, 72.93-72.93DT, 72.94-72.94DT, 780, 80.66-80.66DT, 80.66F-80.66F DT, 80.66S-80.66S DT, 80.76F-80.76F DT, 80.88-80.88DT, 80.90-80.90DT, 82.86F-82.86F DT, 82.86LP-82.86LP DT, 82.93-82.93DT, 82.94-82.94DT, 85.90-85.90DT, 855C, 88.93-88.93DT, 88.94-88.94DT, 880/5, 90.90-90.90DT, 955C, 980, F100-F100DT, F110-F110DT, F115-F115DT, F120-F120DT, F130-F130DT, F140-F140DT	5096235, 596152, 77902285
<b>40584</b>		DEXTA - SUPER DEXTA	81716947
<b>40585</b>	<b>FORD</b>	DEXTA, SUPER DEXTA	81716946
<b>42131</b>		MAJOR, POWER MAJOR, SUPER MAJOR	81718097, E1ADKN8333
<b>40584</b>		4000 SPECIAL, 4530V-5530F-5530L-5530V, 4560V-5560F-5560L-5560V, 5000DT, 5500, 5830-6030-6030F-6030L-6030V, 5840 - 6040, 5860-6060-6060F-6060L-6060V, 5870 - 6070, ADVANTAGE 55F-55FP-55GE, ADVANTAGE 55GT-55GTP-55L-55LP, ADVANTAGE 55V-60F-60GT-60L, BLIZZARD:50, BLIZZARD:60, CINGOLATI: CF5830, CINGOLATI:C4500, CINGOLATI:C4830, CINGOLATI:C5000, CINGOLATI:C5500, CINGOLATI:C5830, CINGOLATI:CF4830, CINGOLATI:CF5030, CINGOLATI:CF6030, REX 60FP-60GE-60GTP-60LP, TREKKER:CF55, TREKKER:CF60	U5MH0006
<b>40585</b>	<b>LANDINI</b>	4000SPECIAL - 5000DT, 4530V-5530F-5530L-5530V, 4560V-5560F-5560L-5560V, 5500, 5830-6030-6030F-6030L-6030V, 5840 - 6040, 5860-6060-6060F-6060L-6060V, 5870 - 6070, ADVANTAGE 55F-55FP-55GE-55GT, ADVANTAGE 55GTP-55L-55LP, ADVANTAGE 60F-60GT-60L, BLIZZARD:50, BLIZZARD:60, CINGOLATI: CF5830, CINGOLATI: CF6030, CINGOLATI:C4500, CINGOLATI:C4830, CINGOLATI:C5000, CINGOLATI:C5500, CINGOLATI:C5830, CINGOLATI:CF4830, CINGOLATI:CF5030, GLOBUS:50, GLOBUS:55, REX 60FP-60GE-60GTP-60LP, REX 60V - 65V, REX CAB E FOOT STEP:60, TREKKER:CF55, TREKKER:CF60, VIGNETI CAB E FOOT STEP:55V, VIGNETI REX CAB:60V	U5MH0001
<b>40589</b>		6000-6000SPECIAL-7000SPECIAL, 6500, 6505, C6000	U5MH0011, U5MH0065
<b>40584</b>		133, 134C, 134V, 135, 135V, 140, 145, 145S, 145V, 148, 150, 152, 152F, 152S, 152V, 154, 154C, 154F, 154S, 154V, 164TF, 164TS, 164TV, 20, 203, 205, 20B, 20C, 20D, 20E, 20F, 2135, 2203, 2205, 230, 233, 234C, 234CF, 234S, 235, 240, 244CF, 245, 24T, 250, 250X, 253, 254, 254C, 254CF, 254S, 263T, 264T, 264TCF, 264TS, 30B, 30E, 30H, 3210FP, 3210GE, 3210SP, 333, 334V, 340, 342, 35, 350, 352, 353, 353LX, 353S, 354AP, 354AQ, 354F, 354FP, 354FQ, 354GE, 354S, 354SP, 354SQ, 354V, 354VQ, 355, 356CF, 360, 40, 40E, 415, 550	731256M1, 747936M91, 976731M1, U5MH0006
<b>40585</b>		133, 134C, 134V, 135V, 140, 145, 145S, 145V, 150, 152, 152F, 152S, 152V, 154, 154C, 154F, 154S, 154V, 20, 203, 205, 20B, 20C, 20D, 20E, 20F, 2135, 2203, 2205, 233, 234C, 234CF, 234S, 235, 244CF, 245, 24T, 250X, 253, 254, 254C, 254CF, 254S, 255, 340, 342, 350, 30B, 30E, 30H, 3210FP - 3210GE - 3210SP, 333, 334V, 35, 135, 148, 230, 240, 250, 353, 353LX, 353S, 354AP, 354AQ, 354F, 354FP, 354FQ, 354GE, 354S, 354SP, 354SQ, 354V, 354VQ, 356CF, 40, 415, 550	732443M1, 747939M91, U5MH0001
<b>40588</b>	<b>MASSEY FERGUSON</b>	702, 835, FE35	826199M1
<b>40589</b>		155, 158, 158F, 158S, 158V, 165, 260, 30, 302, 304, 3165, 3303, 3305, 356, 40B, 50, 560, 65, 765, 865	3637426M91, 4223777M91, U5MH0011, U5MH0065
<b>40592</b>		164TF - 164TS - 164TV, 253 - 263T, 264T - 264TCF - 264TS, 352 - 355 - 360 - 363, 364AP-364AQ-364CF-364F-364FP, 364FQ-364GE-364S-364SP-364SQ, 364V - 364VQ - 366CF, 40E	3637574M91, U5MH0017
<b>40593</b>		1004T, 265, 292, 365, 375, 390, 390T, 398, 425, 460, 610 TURBO - 620, 698T	3637572M1, 3638251M91, U5MH0052
<b>40594</b>		1004T, 292, 365, 375, 390, 390T, 398, 698T, 460, 5275 - 5285 - 5290, 5340, 610 TURBO - 620	3637573M91, U5MH0047
<b>40595</b>		1014 - 1024 - 1114, 2620, 2625, 2640, 2645, 2675, 2680, 2685, 2705, 2720, 2725, 3080, 3090, 3610, 3630, 3650, 399, 699	3637427M91, U5MH0028

Art./Ref.	Brand	Applicazione/Application	Rif. Orig./Orig. Ref.
<b>08626</b>	<b>NEW HOLLAND</b>	L60, L65, L75, L85, L95, SERIE TL, TK100.55, TK100A, TK55, TK55.65 F, TK55.65 M, TK55.65 V, TK55.75 F, TK55.75 M, TK55.75 V, TK55.85 F, TK55.85 M, TK55.85 V, TK60.65, TK60.65 M, TK60.65 V, TK60.75 F, TK60.75 M, TK60.75 V, TK60.85 F, TK60.85 M, TK60.85 V, TK62.85, TK62.85 M, TK62.85 V, TK65, TK65F, TK65V, TK70, TK70.65, TK70.65 M, TK70.65 V, TK70.75 F, TK70.75 M, TK70.75 V, TK72.85, TK72.85 M, TK75, TK75A, TK75F, TK75FA, TK75M, TK75MA, TK75V, TK75VA, TK76, TK76M, TK80.65, TK80.66 DT, TK80.75, TK80A, TK80MA, TK82.85 M, TK85, TK85.55, TK85M, TK88.85 M, TK90A, TK90MA, TK95.55, TK95M, TL65, TL70, TL80, TL90, TL100, TN55D, TN55S, TN55V, TN60DA, TN60SA, TN60VA, TN65D, TN65F, TN65N, TN65S, TN65V, TN70D, TN70DA, TN70F, TN70NA, TN70S, TN70SA, TN70VA, TN75D, TN75DA, TN75F, TN75FA, TN75N, TN75NA, TN75S, TN75SA, TN75V, TN75VA, TN80F, TN85FA, TN90F, TN95F, TN95FA, TN95NA, TN95VA	5096235, 596152, 77902285

**MANICOTTI INFERIORI ADATTABILI**

MANCHONS ADAPTABLE

HOSE ADAPTABLE

KUEHLERSCHLAHUELSE PASSEND ZU

MANGOS ADAPTABLE



Art./Ref.	Brand	Applicazione/Application	Rif. Orig./Orig. Ref.
<b>08626</b>	<b>CASE</b>	AVJ55 - AVJ60 - AVJ70, JX100U-JX1060C-JX1060V, JX1070C-JX1070N-JX1070V, JX1075C-JX1075N-JX1075V, JX1095N-JX1095V, JX55-JX60-JX65-JX70, JX70U-JX75-JX80-JX80U, JX85-JX90-JX90U-JX95, VJ60 - VJ70 - VJ80	596152
<b>28504</b>		JX100U, JX70U, JX80U, JX90U	4997262

<b>08562</b>	<b>FIAT</b>	411R, 415	10134986
<b>08626</b>		100.90-100.90DT, 1000, 110.90-110.90 DT, 115.90-115.90 DT, 1180, 130.90-130.90 DT, 140.90-140.90 DT, 35.66-35.66DT, 45.66-45.66DT, 45.66S-45.66S DT, 450, 450R, 450V, 455C, 480, 480V, 50.66-50.66DT, 50.66S-50.66S DT, 500, 500S, 505C, 540, 540V, 55.46-55.46DT, 55.56-55.56DT, 55.66-55.66DT, 55.66LP-55.66LP DT, 55.66S-55.66S DT, 55.88-55.88DT, 55.90-55.90DT, 550, 555C, 56.66S-56.66S DT, 580, 60.46-60.46 DT, 60.56-60.56 DT, 60.66-60.66 DT, 60.66F-60.66F DT, 60.66LP-60.66LP DT, 60.66S-60.66S DT, 60.76F-60.76F DT, 60.88-60.88 DT, 60.90-60.90DT, 60.93-60.93DT, 60.94-60.94 DT, 600, 605C, 62.86F-62.86F DT, 640, 65.46-65.46DT, 65.56-65.56DT, 65.66-65.66DT, 65.66S-65.66S DT, 65.88-65.88DT, 65.90-65.90DT, 65.93-65.93 DT, 65.94-65.94 DT, 680, 70.56-70.56DT, 70.66-70.66DT, 70.66F-70.66F DT, 70.66LP-70.66LP DT, 70.66S-70.66S DT, 70.66V-70.66V DT, 70.76F-70.76F DT, 70.76LP-70.76LP DT, 70.76V-70.76V DT, 70.88-70.88DT, 70.90-70.90DT, 72.86F-72.86F DT, 72.86LP-72.86LP DT, 72.93-72.93DT, 72.94-72.94DT, 780, 80.66-80.66DT, 80.66F-80.66F DT, 80.66S-80.66S DT, 80.76F-80.76F DT, 80.88-80.88DT, 80.90-80.90DT, 82.86F-82.86F DT, 82.86LP-82.86LP DT, 82.93-82.93DT, 82.94-82.94DT, 85.90-85.90DT, 855C, 88.93-88.93DT, 88.94-88.94DT, 880/5, 90.90-90.90DT, 955C, 980, F100-F100DT, F110-F110DT, F115-F115DT, F120-F120DT, F130-F130DT, F140-F140DT	5096235, 596152, 77902285
<b>28504</b>		100.90-100.90DT, 110.90-110.90DT, 55.90-55.90DT, 570, 580, 60.90-60.90DT, 65.90-65.90DT, 65.94-65.94DT, 670, 680, 70.90-70.90DT, 72.94-72.94DT, 80.90-80.90DT, 82.94-82.94DT, 90.90-90.90DT	4997262
<b>36414</b>		SOM880/4	4997337

<b>08626</b>	<b>FORD</b>	3010S - 4010S - 5010S, 3435, 3935, 4030 - 4230 - 4430 - 8430, 4135, 4635, 4835, 5635, 6635, 7635	596152, 77902285
<b>21821</b>		2000, 2100, 2110, 2120, 2150, 2300, 231 - 233 - 333 - 335 - 420, 2310, 2600, 2610, 2810, 2910, 3000, 3100, 3120, 3150, 3190, 3230, 3300, 3310, 3400, 3430, 3500, 3600, 3610, 3900, 3910, 3930, 4000, 4100, 4110, 4130, 4140, 4190, 4200, 4400, 4450, 4500, 4550, 4600, 4610, 4630, 4830, 5030	81805637, C5NN8286B
<b>21822</b>		5000, 5100, 5110, 5190, 5200, 5550, 5600, 5610, 5900, 6550, 6600, 6610 SENZA ARIA CONDIZIONATA, 7000, 7100, 7550, 7600	81805638, C5NN8286C
<b>28504</b>		4635, 4835, 5635, 7635	4997262
<b>41888</b>		8530, 8630, 8730, 8830, TW 15, TW 25, TW 35, TW 5	83933452, D8NN8B298AB
<b>41889</b>		7910, 8210	83929876, E1NN8291AA
<b>42152</b>		5640, 6640, 7740, 7840, 8240, 8340	81862945, 81863336, 81868754, F0NN8286AA, F0NN8286AB
<b>42161</b>		8000, 8200, 8600	81820455, C7NN8286A

<b>38752</b>	<b>JOHN DEERE</b>	1020, 1030, 10300U, 1030VU, 1035, 1035EF, 1035EV, 1040, 1040V, 1120, 1130, 1140, 1140F, 1140V, 1350, 1520, 1550, 1630, 16300U, 1630VU, 1635, 1635EF, 1635EV, 1750, 1750V, 1830, 1850, 1850F, 1850N, 1850V, 2020, 2030, 20300U, 2035, 2035EF, 2040, 2120, 2130, 2135, 2150, 2155, 2240, 2440, 820, 830, 840, 920, 930, 930VU, 940, 940V	T22500
<b>38755</b>		2940, 2950, 3040, 3140, 3150, 3340, 3640, 3640S, 4040	L34922

<b>40618</b>	<b>LANDINI</b>	6550, 7550, 8550	1427275M1
<b>40638</b>		16000, 16500	3040882M92

Art./Ref.	Brand	Applicazione/Application	Rif. Orig./Orig. Ref.
40555	MASSEY FERGUSON	3125, 3140, 3635, 3645, 3655, 3660	3581959M1
40597		35	828147M1
40599		133, 135, 135V, 140, 145, 145S, 145V, 148, 152, 152F, 152S, 152V, 40	186968M1, 414136M1
40600		135, 135V, 148, 20B, 20E, 230, 235, 240, 245, 250, 255	1860374M2
40603		340, 342, 350, 352, 355, 360	1694711M3
40604		20D, 550	1662089M1
40606		TEA20, TED20, TEH20	7126
40608		FE35	826988M1
40609		TEF20	2413
40611		35, 65, 765, 865	826775M1
40613		165, 50	898065M1
40615		165, 168, 168F, 168S, 175S, 185, 265, 275, 275E, 30D,50,50B,50B MKII,50D,50E, 375E, 50EX,50H,50H-S,50HX,50HX-S, 565, 60H,60H-S, 675	194737M1, 898748M1
40618		284S, 294S	1427275M1
40620		362, 362N, 372N, 382N	1695868M1
40622		365, 375, 390, 390T, 398	1695562M1
40624		399	1695564M1
40630		1004, 298, 698	1669806M1
40638		2620, 2625, 2640, 2645, 2680, 2685, 2720, 2725, 3610, 3630, 3650	3040882M92
40640		3050, 3060, 3065, 3065S	3382984M1
40644		3080, 3090	3382985M1

08626	NEW HOLLAND	L60, L65, L75, L85, L95, SERIE TL, TK100.55, TK100A, TK55, TK55.65 F, TK55.65 M, TK55.65 V, TK55.75 F, TK55.75 M, TK55.75 V, TK55.85 F, TK55.85 M, TK55.85 V, TK60.65, TK60.65 M, TK60.65 V, TK60.75, TK60.75 F, TK60.75 M, TK60.75 V, TK60.85 F, TK60.85 V, TK60A, TK62.85, TK62.85 M, TK65, TK65F, TK65V, TK70, TK70.65, TK70.65 M, TK70.75, TK70.75 M, TK70A, TK70FA, TK70VA, TK72.85, TK72.85 M, TK75, TK75A, TK75F, TK75FA, TK75M, TK75MA, TK75V, TK75VA, TK76, TK76M, TK80.65, TK80.66 DT, TK80.75, TK80A, TK80MA, TK82.85 M, TK85, TK85.55, TK85M, TK88.85 M, TK90A, TK90MA, TK95.55, TK95M, TL65, TL70, TL80, TL90, TL100, TN55D, TN55S, TN55V, TN60DA, TN60SA, TN60VA, TN65D, TN65F, TN65N, TN65S, TN65V, TN70D, TN70DA, TN70F, TN70NA, TN70S, TN70SA, TN70VA, TN75D, TN75DA, TN75F, TN75FA, TN75N, TN75NA, TN75S, TN75SA, TN75V, TN75VA, TN80F, TN85FA, TN90F, TN95F, TN95FA, TN95NA, TN95VA	5096235, 596152, 77902285
28504		L60, L65, L75, L85, L95, TL100, TL70, TL80, TL90	4997262
42152		TS120 (BRASIL), TS80, TS90, TS100, TS110, TS115, TS90E, TS100E, TS115E	81862945, 81863336, 81868754

**TAPPI RADIATORI ADATTABILI**

BOUCHONS RADIATEUR ADAPTABLE

RADIATOR PLUGS ADAPTABLE

CAPS KÜHLER PASSEND ZU

TAPONES DE RADIADOR ADAPTABLE



Art./Ref.	Brand	Applicazione/Application	Rif. Orig./Orig. Ref.
08487	FIAT	100.90-100.90 DT, 110.90-110.90 DT, 1300, 1380, 1580, 1880, 35.66-35.66 DT, 45.66-45.66 DT, 45.66S-45.66S DT, 45.76V-45.76V DT, 470, 474, 580, 680, 780, 855, 50.66-50.66 DT, 50.66S-50.66S DT, 50.86S V-50.86S V DT, 50.86V-50.86V DT, 55.46-55.46 DT, 55.56-55.56 DT, 55.66-55.66 DT, 55.66F-55.66F DT, 55.66S-55.66S DT, 55.66V-55.66V DT, 55.76F-55.76F DT, 55.76V-55.76V DT, 55.86F-55.86F DT, 55.86S V-55.86S V DT, 55.86V-55.86V DT, 55.88-55.88 DT, 55.90-55.90 DT, 56.66S-56.66S DT, 60.46-60.46 DT, 60.56-60.56 DT, 60.66-60.66 DT, 60.66S-60.66S DT, 60.76F-60.76F DT, 60.86F-60.86F DT, 60.86S V-60.86S V DT, 60.86V-60.86V DT, 60.88-60.88 DT, 60.90-60.90 DT, 60.93-60.93 DT, 60.94-60.94 DT, 62.86F-62.86F DT, 65.46-65.46 DT, 65.56-65.56 DT, 65.66S-65.66S DT, 65.88-65.88 DT, 65.90-65.90 DT, 65.93-65.93 DT, 65.94-65.94 DT, 70.56-70.56 DT, 70.66-70.66 DT, 70.66S-70.66S DT, 70.76F-70.76F DT, 70.76LP-70.76LP DT, 70.76V-70.76V DT, 70.86S V-70.86S V DT, 70.86V-70.86V DT, 70.88-70.88 DT, 70.90-70.90 DT, 72.86F-72.86F DT, 72.86LP-72.86LP DT, 72.93-72.93 DT, 72.94-72.94 DT, 80.66-80.66 DT, 80.66S-80.66S DT, 80.76F-80.76F DT, 80.76F.80.76F DT, 80.88-80.88 DT, 80.90-80.90 DT, 82.86F-82.86F DT, 82.86LP-82.86LP DT, 82.93-82.93 DT, 82.94-82.94 DT, 85.90-85.90 DT, 88.93-88.93 DT, 88.94-88.94 DT, 880, 955, 980, 1180, 1280, 90.90-90.90 DT, F100 - F100DT, F110 - F110DT, F115 - F115DT, F120 - F120DT, F130 - F130DT, F140 - F140DT	4999682

Art./Ref.	Brand	Applicazione/Application	Rif. Orig./Orig. Ref.
<b>08497</b>	<b>FIAT</b>	100.90-100.90 DT, 1000, 110.90-110.90 DT, 1180, 1280, 1300, 1355C, 1380, 1580, 1880, 200R, 211RB, 215C, 221, 250, 255, 300, 311, 312, 315, 321, 331, 332, 35.66-35.66 DT, 350, 351, 352C, 355C, 366, 400, 411, 412, 415, 420, 421, 431, 440, 441, 446, 45.66-45.66 DT, 450, 451, 455C, 460, 465, 466, 470, 474, 480, 50.66-50.66 DT, 50.86-50.86 DT, 500, 500 ST, 505C, 540, 55.46-55.46 DT, 55.56-55.56 DT, 55.66-55.66 DT, 55.66S-55.66S DT, 55.86-55.86 DT, 55.88-55.88 DT, 55.90-55.90 DT, 550, 565C, 566, 570, 580, 60.46-60.46 DT, 60.56-60.56 DT, 60.66-60.66 DT, 60.88-60.88 DT, 60.90-60.90 DT, 60.93-60.93 DT, 60.94-60.94 DT, 600, 605C, 640, 65.46-65.46 DT, 65.56-65.56 DT, 65.66-65.66 DT, 65.88-65.88 DT, 65.90-65.90 DT, 65.93-65.93 DT, 65.94-65.94 DT, 650, 655, 655C, 666, 670, 680, 70.56-70.56 DT, 70.66-70.66 DT, 70.88-70.88 DT, 70.90-70.90 DT, 72.93-72.93 DT, 72.94-72.94 DT, 750, 765, 766, 780, 80.66-80.66 DT, 80.88-80.88 DT, 80.90-80.90 DT, 805, 82.93-82.93 DT, 82.94-82.94 DT, 850, 855C, 88.93-88.93 DT, 88.94-88.94 DT, 880, 880-5, 90.90-90.90 DT, 900, 95.55-95.55 DT, 980, 995C, A100SDT-A110-A110SDT, A140-A140DT-A90SDT, F100-F110-F115-F120-F130, G170-G190-G210-G240	4988491, 590054, 9966958
<b>14025</b>		1355C, FL14E-FR10-FR10B-FR15B, FR20-FR20B-FR20B TURBO, FR7-FR8-FR9-FD14E	4957787, 4959324, 576992, 76008464, 76027863, 8512472, 76008464, 76027863
<b>14492</b>		100.90-100.90 DT, 110.90-110.90 DT, 55.90-55.90 DT, 60.90-60.90 DT, 65.90-65.90 DT, 65.94-65.94 DT, 70.66-70.66 DT, 70.66S-70.66S DT, 70.90-70.90 DT, 72.94-72.94 DT, 80.66-80.66 DT, 80.66S-80.66S DT, 80.90-80.90 DT, 82.94-82.94 DT, 85.90-85.90 DT, 88.94-88.94 DT, 90.90-90.90 DT, F100-F100 DT, F110-F110 DT, F115-F115 DT, F120-F120 DT, F130-F130 DT, F140-F140 DT	4274034
<b>26775</b>		115.90, 115.90DT, 130.90, 130.90DT, 140.90, 140.90DT, 160.90, 160.90DT, 180.90, 180.90DT, TK160.55	5129231
<b>08487</b>	<b>FORD</b>	3435, 4135, 4635, 4835, 5635, 3830, 4030, 4230, 4430, 6635, 7635	4999682
<b>08497</b>		4635-4835-5635-6635-7635	4988491, 590054, 9966958
<b>14492</b>		4635, 4835, 5635, 6635, 7635	4274034
<b>21817</b>		2000, 2310, 2600, 2610, 2810, 2100-2300-3100-3300-4200-4400, 2110-3310-6410-6610-6710-6810, 2120-231-233-3120-333-335, 2150, 3150, 2910, 3000, 3055, 3600, 3610, 3190, 4190, 5190, 3230, 3400-3500-4140-420-4450-4500, 3430, 3900, 3910, 4000, 4100, 4110, 3930, 4130, 4550-5550-6550-7550, 4600, 4610, 5000, 5110, 5610, 4630, 4830, 5030, 5100-5200-5600-5700-5900, 5610S, 5640, 6410, 6610, 7000, 7410, 5600, 6600, 7610, 7710, 6600-6700-7100-7600-7700, 6610S, 6640, 7000, 8000, 9000, 7010, 7410-7610-7710-7910-8210, 7610S, 7740, 7810, 7810S, 7840, 7910, 8210, 8530, 8630, 8730, 8010, 8240, 8340, 8530, 8630, 8730, 8830, 8600-8700-9200-9600-9700, 8670, 8770, 8830, TW5, TW15, TW25, TW35, 8870, 8970, TW10, TW20, TW30	211E8100A1, 81854756, 83917658, 83935905, D2AE8100A1A, E2NN8100BA
<b>26775</b>	8430, 8630, 8830	5129231	
<b>42056</b>	DEXTA, MAJOR, POWER MAJOR, SUPER DEXTA, SUPER MAJOR	81711544, 81711545, 87712917, E62A8100A	
<b>08497</b>	<b>LANDINI</b>	10000, 12500, 13000, 14500, 4000/DT, 4000R, 4000S, 4500R, 5000/DT, 5000/N, 5000/S, 5000R, 5500, 5830, 5840, 5860, 5870, 6030, 6040, 6060, 6070, 6500, 6550, 6830, 6840, 6860, 6870, 6880, 7500, 7550, 7830, 7860, 7870, 7880, 8500, 8550, 8830, 8860, 8870, 8880, 9060, 9080, 9880, ADVANTAGE CAB E FOOT STEP: 60, ADVANTAGE CAB E FOOT STEP: 75, ADVANTAGE CAB E FOOT STEP: 85, ADVANTAGE CAB E FOOT STEP: 55, ADVANTAGE CAB E FOOT STEP: 60, ADVANTAGE CAB E FOOT STEP: 65, ADVANTAGE CAB: 85, CLIMA TROPICA, ADVANTAGE: L95GT, ATLAS: 70, ATLAS: 75, ATLAS: 80, ATLAS: 100, ATLAS: 85, ATLAS: 90, BLIZZARD: 50, BLIZZARD: 60, BLIZZARD: 65, BLIZZARD: 75, BLIZZARD: 85, BLIZZARD: 95, CINGOLATI :C6830(FINO A 320B01, CINGOLATI: C6830, CINGOLATI: C7830, CINGOLATI: C4500, CINGOLATI: C4830, CINGOLATI: C5500, CINGOLATI: C5830, CINGOLATI: C6500, CINGOLATI: C7800, CINGOLATI: C8860, CINGOLATI: CF4830, CINGOLATI: CF5030, CINGOLATI: CF5830, CINGOLATI: CF6030, CINGOLATI: CF6060, CINGOLATI: CF6830, FRUTTETI 530 F/L/V: 6030F/L, FRUTTETI 530 F/L/V: 4530V, FRUTTETI 530 F/L/V: 5530F/L, FRUTTETI 530 F/L/V: 5530V, FRUTTETI 530 F/L/V: 6030F/L, CLI, FRUTTETI 530 F/L/V: 6030V, FRUTTETI 530 F/L/V: 6030V, CLIMA, FRUTTETI 530 F/L/V: 6530F/L/V, FRUTTETI 530 F/L/V: 6530F/V, FRUTTETI 530 F/L/V: 6530L, FRUTTETI 530 F/L/V: 7530F, FRUTTETI 530 F/L/V: 7530F/L, FRUTTETI 530 F/L/V: 7530L, FRUTTETI 530 F/L/V: 8530F, FRUTTETI 530 F/L/V: 8530L, FRUTTETI 530 F/L/V: 8530L, CLIMA, FRUTTETI 560 F/L/V: 5560F/L, FRUTTETI 560 F/L/V: 5560V, FRUTTETI 560 F/L/V: 6060F/L, FRUTTETI 560 F/L/V: 6060V, FRUTTETI 560 F/L/V: 6060V, CLIM, FRUTTETI 560 F/L/V: 6560F/L, FRUTTETI 560 F/L/V: 7560F/L, FRUTTETI 560 F/L/V: 8560F/L, CL, FRUTTETI 560F/L/V: 6560V, FRUTTETI 560F/L/V: 8560 F/L, NEW SERIE 60: 5860, NEW SERIE 60: 6860, NEW SERIE 60: 7860, NEW SERIE 60: 8860, REX CAB E F.S: 100, REX CAB E F.S: 70, REX CAB E F.S: 80, REX CAB E F.S: 90, REX CAB E F.S: 60, REX CAB E F.S: 60, SENZA ARIA CO, TEKKER CF: CF55, TEKKER CF: CF60, VIGNETI CAB E F.S: 60V, VIGNETI CAB E F.S: 55V, VIGNETI CAB E F.S: 60V, CLIMA TR, VIGNETI CAB E F.S: 65V, VIGNETI CAB E F.S: 75V, VIGNETI REX CAB TIER 2: 75V, VIGNETI REX CAB TIER 2: 85V, VIGNETI REX CAB: 60V, VIGNETI REX CAB: 65V, VIGNETI REX CAB: 65V, SENZA ARI, VIGNETI REX CAB: 70V, VIGNETI REX CAB: 80V	1824628M91
<b>08497</b>	<b>MASSEY FERGUSON</b>	1007-1014-1024, 1104-1114-1134, 134C-134V, 154-154C-154F-154S-154V, 164TF-164TS-164TV, 174-174C-174F-174S-174V, 184-184F-184S-194S, 233-234C-234CF-234S-244CF, 253-254-254C-254CF-254S, 263T-264T-264TCF-264TS, 274CF-274S-274SK, 283-284-284S, 293-294-294C-294S, 3210FP-3210GE-3210SP, 3220AP-3220FP-3220GE-3220SP, 3225AP-3225FP-3225GE-3225SP, 3235AP-3235FP-3235GE-3235SP, 333-334V-353-353LX-353S, 354AP-354AQ-354FP-354FQ, 354GE-354S-354SP-354VQ, 356CF-363-363LX-363S, 364AP-364AQ-364CF-364FP-364FQ, 364GE-364S-364SP-364SQ-364V, 364VQ-366CF-367CF, 373-373LX-373S-374AP-374AQ, 374F-374FP-374FQ-374S-374SP, 374SQ-374V-374VQ-376C-376CF, 376XCF-377, 383-383LX-383S-384AP-384AQ, 384F-384FP-384FQ-384GE-384S, 384SP-384SQ-384V-384VQ, 393LX-393S-393TLX, 394AP-394AQ-394C-394F-394FP, 394FQ-394H-394S-394SP-394SQ, 394TAQ-396C-396CF-396CT, 397-397T	1824628M91
<b>11291</b>		133, 135, 135V, 140, 145, 145S, 165, 168, 168F, 168S, 175S, 178, 185, 188	24850017, 24850020, 3637301M1, 3637939M1, 885344M1
<b>11292</b>		230, 235, 240, 245, 253, 255, 260, 263, 263T, 265, 275, 275E, 285, 290, 290E, 298, 375E, 390E, 550, 560, 565, 575, 590	1874445M93, 1874445M94

Art./Ref.	Brand	Applicazione/Application	Rif. Orig./Orig. Ref.
11890	MASSEY FERGUSON	133, 135, 135V, 140, 145, 145S, 145V, 148, 152, 152F, 152S, 152V, 155, 158, 158F, 158S, 158V, 165, 175, 35, 65, 765, 865, FE35	3475308M1, 826772M1, 968976M2
40582		1080 - 1085, 592 - 595	531505M91
08487	NEW HOLLAND	L60-L65-L75-L85-L95, TD4020F-TD4030F-TD4040F, TD55D-TD65D-TD75D-TD85D, TD60-TD70-TD80-TD90-TD95, TD65F-TD75F-TD85F, TK100A, TK65F, TK65V, TK70FA, TK70VA, TK75F, TK75FA, TK75M, TK75MA, TK75V, TK75VA, TK76, TK76M, TK80A, TK80MA, TK85, TK85M, TK90A, TK90MA, TK95M, TL70-TL80-TL90-TL100, TL70A-TL80A-TL90A-TL100A, TN55-TN65-TN70-TN75, TN55D-TN65D-TN70D-TN75D, TN55S-TN65S-TN70S-TN75S, TN55V-TN65V-TN75V, TN60A-TN70A-TN75A-TN85A-TN95A, TN60DA, TN60SA-TN70SA-TN75SA-TN75SA, TN60VA-TN70VA-TN75VA-TN95VA, TN65F, TN65F-TN70F-TN75F, TN65N, TN70DA, TN70F, TN70NA-TN95NA, TN75DA, TN75F, TN75FA, TN75FA-TN85FA-TN95FA, TN75N, TN75NA, TN80F, TN80F-TN90F-TN95F, TN85DA, TN90F, TN95DA, TN95F, TN95FA, TT50-TT55-TT65-TT75	4999682
08497		L411-L413-L416-L516, L60-L65-L75-L80, L85-L90-L95-L115, M100-M115-M135-M160, TD55D-TD65D-TD75D-TD85D-TD95D, TK65F-TD65V, TK76-TK76M, TK85-TK85M, TL70-TL80-TL90-TL100, TN55-TN65-TN70-TN75-TN90, TN55D-TN65D-TN70D-TN75D, TN55S-TN65S-TN70S-TN75S, TN55V-TN65V, TN65F-TN70F-TN75F, TN65N, TN80F-TN90F-TN95F	4988491, 590054, 9966958
14492		L60-L65-L75-L85-L95, T4.105N-T4.95N-T4.95V, T4.105V-T4.85V-T4.85N, T4.55-T4.65-T4.75, T4.75F-T4.85F-T4.95F-T4.105F, T4.75V-T4.65V-T4.75N, T4020-T4030-T4040-T4050, T4020V-T4030V-T4040V, T4030F-T4040F-T4050F-T4060F, T4030N-T4040N-T4050N-T4060N, T4050V-T4060V, T5030-T5040-T5050-T5060-T5070, TC45A, TD4020F-TD4030F-TD4040F, TD5.100-TD5.105-TD5.110, TD5.115, TD5.65-TD5.75-TD5.80-TD5.85, TD5.90-TD5.95, TD5010-TD5020-TD5030, TD5040-TD5050, TD60-TD70-TD80-TD90-TD95, TD60D-TD70D-TD80D-TD90D-TD95D, TD65F-TD75F-TD85F, TK100-55, TK100A, TK4020F, TK4020V, TK4030, TK4030F, TK4030V, TK4040, TK4040M, TK4050, TK4050M, TK4060, TK70FA, TK70VA, TK75F, TK75FA, TK75M, TK75MA, TK75V, TK75VA, TK85.55, TK90A, TK90MA, TK95.55, TK95M, TL100, TL60-TL65-TL70-TL75, TL60E-TL75E-TL85E-TL95E, TL70A-TL80A-TL90A-TL100A, TL80-TL85-TL90-TL95, TN55-TN65-TN70-TN75, TN55D-TN65D-TN70D-TN75D, TN55S-TN65S-TN70S-TN75S, TN60A-TN70A-TN75A-TN85A-TN95A, TN65F-TN75F-TN90F, TN65F-TN75F-TN90F-TN95F, TN70DA-TN75DA-TN85DA-TN95DA, TN70NA-TN95NA, TN70SA-TN75SA-TN85SA, TN70VA-TN75VA-TN95VA, TN75N, TN75NA, TN75V, TN85FA-TN95FA, TN95F-TN95FA	4274034
21817		TD5010-TD5020-TD5030, TD5040-TD5050, TD55D-TD60D-TD65D-TD70D, TD65B, TD75D-TD80D-TD85D-TD90D-TD95D, TT65D	83935905

## VENTOLE DI RAFFREDDAMENTO ADATTABILI

VENTILATEUR REFRAICHISSEMENT ADAPTABLE

COOLING FANS ADAPTABLE

KUHLENTILATOREN PASSEND ZU

VENTALLES DE INFRIAMIENTO ADAPTABLE



Art./Ref.	Brand	Applicazione/Application	Rif. Orig./Orig. Ref.	Note/Notes
14240	FIAT	100.90-100.90DT, 1000S, 110.90-110.90DT, 115.90-115.90DT, 1180, 1280, 1380, 90.90-90.90DT, 980	4705372	4 Pale aspirate/4 Wheel aspirated
14244		440V, 450, 540S, 55.46-55.46DT, 55.56-55.56DT, 55.66-55.66DT, 55.66S-55.66S DT, 55.88-55.88DT, 550, 566, 570V/F/DT, 60.46-60.46DT, 60.56-60.56DT, 60.66-60.66DT, 60.66S-60.66S DT, 60.88-60.88DT, 60.93-60.93DT, 60.94-60.94DT, 600DT, 640, 65.46-65.46DT, 65.56-65.56DT, 65.66-65.66DT, 65.66S-65.66S DT, 65.88-65.88DT, 65.93-65.93DT, 666, 70.56-70.56DT, 70.66-70.66DT, 70.66S-70.66S DT, 70.88-70.88DT, 72.93-72.93DT, 766, 80.66-80.66DT, 80.66S-80.66S DT, 80.88-80.88DT, 82.93-82.93DT, 88.93-88.93DT		4 Pale aspirate/4 Wheel aspirated
14246		1300S	4698308, 8827731, 8829763	4 Pale aspirate/4 Wheel aspirated
14331		1280, 130.90-130.90DT, 1380	4720206, 4796434, 4796435, 5171295	6 Pale aspirate/6 Wheel aspirated
14249				
14250				
14245R		450R, FL4D	4606454	
14244	FORD	3010S - 4010S - 5010S	4593320	4 Pale aspirate/4 Wheel aspirated
14331		4635, 4835, 5635, 6635, 7635	4796435	6 Pale aspirate/6 Wheel aspirated



Art./Ref.	Brand	Applicazione/Application	Rif. Orig./Orig. Ref.	Note/Notes
<b>42050</b>	<b>FORD</b>	2000, 2100, 2110, 2120, 2300, 230A, 231, 2310, 233, 234, 2600, 2600N, 2600R, 2600V, 2610, 2610V, 2810, 2910, 3000, 3055, 3100, 3120, 3230, 3300, 3310, 333, 3330, 334, 335, 3400, 3430, 345C, 345D, 3500, 3550, 3600, 3600N, 3600NO, 3600R, 3600V, 3610, 3610NO, 3610V, 3900, 3910, 3910H, 3910N, 3910R, 3910V, 3930, 3930H, 3930N, 3930NO, 4000, 4100, 4110, 4110N, 4110NO, 4110O, 4110V, 4130, 4130N, 4130NO, 4140, 420, 4200, 4330, 4340, 4400, 4410, 445C, 445D, 4500, 4600, 4600NO, 4600O, 4600SU, 4610, 4610NO, 4610SU, 4630, 4630N, 4630NO, 4630O, 4830, 4830N, 4830O, 5000, 5030, 5030O, 5100, 515, 5200, 530A, 531, 532, 5340, 535, 545C, 545D, 550, 5500, 555, 555A, 555B, 555C, 555D, 5600, 5640, 5700, 575D, 655, 655A, 655C, 655D, 6600, 6600C, 6600O, 6700, 675D, 7000, 7100, 7200, 7600, 7600C, 7700	83918898	6 Pale aspirate/6 Wheel aspirated
<b>11293</b>	<b>LANDINI</b>	5830	825181M91	4 Pale aspirate/4 Wheel aspirated
<b>11294</b>		4530V, 4560V, 5500, 5505, 5530-5530F-5530L-5530V, 5560F-5560L-5560V, 5830, 5840, 5860, 5870, 6030-6030F-6030L-6030V, 6040, 6060-6060F-6060L-6060V, 6070, 6505, ADVANTAGE 55F-FP-GE-GT-GTP, ADVANTAGE 55L-LP, ADVANTAGE 60F-FP-GE-GT-GTP, ADVANTAGE 60L-LP, BLIZZARD 50 - 60, C4500, C4830, C5500, C5830, C6030F, CF4830, CF5030, CF5830, CF6060, GLOBUS 50, REX 60FP - 60GE - 60LP, REX 60V, REX CAB 60, TREKKER CF55 - CF60, VIGNETI 55V, VIGNETI FOOTSTEP 55V, VIGNETI REX CAB 60V	3539008M91	Pala singola/Single blade
<b>11295</b>		4530V, 4560V, 5500, 5505, 5530-5530F-5530L-5530V, 5560F-5560L-5560V, 5830, 5840, 5860, 5870, 6030-6030F-6030L-6030V, 6040, 6060-6060F-6060L-6060V, 6070, 6505, ADVANTAGE 55F-FP-GE-GT-GTP, ADVANTAGE 55L-LP, ADVANTAGE 60F-FP-GE-GT-GTP, ADVANTAGE 60L-LP, BLIZZARD 50 - 60, C4500, C4830, C5500, C5830, C6030F, CF4830, CF5030, CF5830, CF6060, GLOBUS 50, REX 60FP - 60GE - 60LP, REX 60V, REX CAB 60, TREKKER CF55 - CF60, VIGNETI 55V, VIGNETI FOOTSTEP 55V, VIGNETI REX CAB 60V	3539007M91	Pala singola/Single blade
<b>11296</b>		6500, 6530F, 6530L, 6530V, 6550, 6830, 6840, 7500, 7505, 7530F, 7530L, 7550, 7830, 8500, 8530F, 8530L, 8550, 8830, C6500, C6830, C7800	1885172M1, 894729M1	Pala singola superiore/Single blade top
<b>11297</b>		6500, 6530F, 6530L, 6530V, 6550, 6830, 6840, 7500, 7505, 7530F, 7530L, 7550, 7830, 8500, 8530F, 8530L, 8550, 8830, C6500, C6830, C7800	1885173M1, 894730M1	Pala singola inferiore/Shovel single bottom
<b>40556</b>		6500, 6530L - 6530V, 6550, 6560F - 6560L - 6560V, 6830, 6840, 6860, 6870, 6880, 7500, 7530F - 7530L, 7550, 7560F - 7560L - 7560V, 7830, 7860, 7870, 7880, 8500, 8530F - 8530L, 8550, 8560F - 8560L, 8830, 8860, 8870, 8880, ADVANTAGE:65GTP, ADVANTAGE:75GTP, ADVANTAGE:85GTP, ATLAS:70, ATLAS:75, ATLAS:80, BLIZZARD:65, BLIZZARD:75, BLIZZARD:85, BLIZZARD:95, CINGOLATI:C6500, CINGOLATI:C6830, CINGOLATI:C7800, CINGOLATI:C7830, CINGOLATI:C8860, CINGOLATI:CF6830, GLOBUS:55, GLOBUS:60, GLOBUS:70, REX 60V, REX 65V, REX CAB E FOOT STEP:60, REX CAB E FOOT STEP:70, REX CAB E FOOT STEP:80, TREKKER NEW TIER 2:75, TREKKER NEW TIER 2:85, TREKKER:C70, TREKKER:C75, TREKKER:C85, TREKKER:C95, TREKKER:CF70, TREKKER:CF75, TREKKER:CF80, TREKKER:CF85, TREKKER:CF95, VIGNETI CAB E FOOT STEP:65V, VIGNETI CAB E FOOT STEP:75V, VIGNETI REX CAB :60V, VIGNETI REX CAB :65V, VIGNETI REX CAB :70V, VIGNETI REX CAB :80V	1874995M92	6 Pale aspirate/6 Wheel aspirated
<b>11293</b>	<b>MASSEY FERGUSON</b>	135, 145, 148, 152, 20 - 20B - 20D - 20E - 20F, 230, 240, 250, 253, 30 - 30E - 30H - 40 - 40E, 342, 35 - 35EX - FE35, 350, 355, 360, 550, TE20 - TEA20 - TED20 - TEF20	3638342M91, 825181M91	4 Pale aspirate/4 Wheel aspirated
<b>11294</b>		133, 134C-134V, 135, 135V, 140, 145, 145S-145V, 148, 150, 152, 152F-152S-152V, 154, 154C-154F-154S-154V, 155, 158, 158F-158S-158V, 164TF-164TS-164TV, 165, 2205, 230, 233, 234C-234CF-234S, 235, 240, 243, 244CF, 245, 250, 253, 254, 254C-254CF-254S, 255, 260, 263T, 264T-264TCF-264TS, 3210FP-3210GE-3210SP, 333, 334V, 340, 342, 350, 352, 353-353LX-353S, 354AP-354AQ-354F-354FP-354FQ, 354GE-354S-354SP-354SQ, 354V-354VQ, 355, 356CF, 360, 363-363LX-363S, 364AP-364AQ-364CF, 364F-364FP-364FQ-364GE, 364S-364SP-364SQ-364V-364VQ, 366CF, 550, 560, 65, 765	1884777M1, 897051M1, 963930M1	Pala singola/Single blade
<b>11295</b>		133, 134C-134V, 135, 135V, 140, 145, 145S-145V, 148, 150, 152, 152F-152S-152V, 154, 154C-154F-154S-154V, 155, 158, 158F-158S-158V, 164TF-164TS-164TV, 165, 2205, 230, 233, 234C-234CF-234S, 235, 240, 243, 244CF, 245, 250, 253, 254, 254C-254CF-254S, 255, 260, 263T, 264T-264TCF-264TS, 3210FP-3210GE-3210SP, 333, 334V, 340, 342, 350, 352, 353-353LX-353S, 354AP-354AQ-354F-354FP-354FQ, 354GE-354S-354SP-354SQ, 354V-354VQ, 355, 356CF, 360, 363-363LX-363S, 364AP-364AQ-364CF, 364F-364FP-364FQ-364GE, 364S-364SP-364SQ-364V-364VQ, 366CF, 550, 560, 65, 765	1884738M1, 897050M1, 963929M1	Pala singola/Single blade
<b>11296</b>		165, 168, 168F-168S, 174-174C-174F-174S-174V, 175, 175S, 178, 184-184F-184S, 185, 188, 194-194C-194F-194S, 265, 273, 274-274C-274CF-274S-274SK, 275, 283, 285, 293, 294S, 565, 575, 675	1885172M1, 894729M1	Pala singola superiore/Single blade top
<b>11297</b>		165, 168, 168F-168S, 174-174C-174F-174S-174V, 175, 175S, 178, 184-184F-184S, 185, 188, 194-194C-194F-194S, 265, 273, 274-274C-274CF-274S-274SK, 275, 283, 285, 293, 294S, 565, 575, 675	1885173M1, 894730M1	Pala singola inferiore/Shovel single bottom
<b>40556</b>		174-174C-174F-174S-174V, 194-194C-194F-194S, 265, 273, 274-274C-274CF-274S-274SK, 275, 275E, 283, 284-284S, 290, 290E, 293, 294-294C-294S, 375E, 390E, 394C-394H, 590, 675, 690	1874995M92, 3538983M91	6 Pale aspirate/6 Wheel aspirated
<b>14240</b>	<b>NEW HOLLAND</b>	TK100.55, TK95.55	4705372	4 Pale aspirate/4 Wheel aspirated
<b>14244</b>		TD55D, TD65D, TD75D, TD85D, TK60.65, TK60.65M, TK60.65V, TK60.75, TK60.75M, TK60.75V, TK62.85, TK62.85M, TK70.65, TK70.65M, TK70.75, TK70.75M, TK72.85, TK72.85M, TK80.65, TK80.66DT, TK80.75, TK82.85M, TK88.85M	4593320	4 Pale aspirate/4 Wheel aspirated

Art./Ref.	Brand	Applicazione/Application	Rif. Orig./Orig. Ref.	Note/Notes
14331	NEW HOLLAND	L60 - L65 - L75 - L85 - L95, TD55D, TD60, TD60D, TD65D, TD70, TD70D, TD75D, TD80, TD80D, TD85D, TD90, TD90D, TD95, TD95D, TK100A, TK65F, TK65M, TK70FA, TK70VA, TK75F, TK75FA, TK75M, TK75MA, TK75V, TK75VA, TK76, TK76-M, TK80A, TK80MA, TK85, TK85-M, TK90A, TK90MA, TK95, TK95M, TL70 - TL80 - TL90 - TL100	4796434	6 Pale aspirate/6 Wheel aspirated
NH9971637 <b>ORIGINALE</b>		VN240, VN260	9971637	Elettroventilatore 12V - ORIGINALE CNH//Electric fan 12V - CNH ORIGINAL

**RUBINETTO RADIATORE ADATTABILE**

ROBINET RADIATEUR ADAPTABLE

RADIATOR TAP ADAPTABLE

KUHLERHAHN PASSEND ZU

LLAVE RADIADOR ADAPTABLE



Art./Ref.	Brand	Applicazione/Application	Rif. Orig./Orig. Ref.
08484	FIAT	1000, 100C, 120C, 1300, 1355C, 350, 420, 440, 45.76V, 450, 455C, 470, 474, 480, 50.86S VDT, 50.86V, 500, 505C, 540, 55.66FDT - 55.66V - 55.66VDT, 55.76F - 55.76FDT, 55.76V - 55.76VDT, 55.86F - 55.86FDT, 55.86SV - 55.86V - 55.86VDT, 570, 580, 60.86F - 60.86FDT, 60.86SV - 60.86SVDT, 60.86V - 60.86VDT, 605C, 640, 650, 655C, 670, 70.86SV - 70.86SVDT, 70.86V - 70.86VDT, 70C, 750, 780, 80C, 850, 880S, 980, 1180, 1280, 1380	4573802, 5118499, 8802992
15341		250, 300, 350, 420	568561
15396		415	990254
08484		3830	5118499
11290	FORD	2000, 2100, 2110, 2120, 2150, 2300, 231-233-333-335-420, 2310, 2600, 2610, 2810, 2910, 3000, 3100, 3120, 3150, 3190, 3230, 3300, 3310, 3400, 3430, 3500, 3600, 3610, 3900, 3910, 3930, 4000, 4100, 4110, 4130, 4140, 4190, 4200, 4400, 4450, 4500, 4550, 4600, 4610, 4630, 4830, 5000, 5030, 5100, 5110, 5190, 5200, 5550, 5600, 5610, 5610S, 5700, 5900, 6410, 6550, 6600, 6610, 6610S, 6700, 6710, 6810, 6810S, 7000, 7010, 7100, 7410, 7550, 7600, 7610, 7610S, 7700, 7710, 7810S, 7910, 8000, 8010, 8200, 8210, 8530, 8600, 8630, 8700, 8730, 8830, 9000, 9200, 9600, 9700, DEXTA, SUPER DEXTA, MAJOR, POWER MAJOR, SUPER MAJOR, TW10, TW20, TW30, TW5, TW15, TW25, TW35	81465471, 81821817, 81859483
11290	JOHN DEERE	1020, 1030, 1030VU, 1035EV, 1040, 1040V, 1120, 1130, 1140, 1140F - 1140V, 1350, 1520, 1530, 1550, 1630, 16300U - 1630VU, 1635, 1635EF, 1635EV, 1640, 1640F, 1750, 1750V, 1830, 1840, 1840F, 1850, 1850F - 1850N - 1850V, 2020, 2030, 20300U, 2035, 2035EF, 2040, 2040S, 2120, 2130, 2135, 2140, 2150, 2155, 2240, 2250, 2350, 2355, 2440, 2450, 2450F, 2550, 2555CS - 2555TSS, 2650, 2650CS - 2650F - 2650N, 2650TSS, 2750, 2755, 2840, 2850, 2855N, 2940, 2950, 2955, 3030, 3040, 3050, 3130, 3135, 3140, 3150, 3340, 3350, 3640, 3640S, 3650, 4040, 4040S, 5103, 5200, 5203, 5210, 5215, 5215F - 5215V, 5220, 5300, 5300N, 5303, 5310, 5310N, 5315, 5315F - 5315V, 5320, 5320N, 5400, 5400N, 5403, 5410, 5410N, 5415, 5415F - 5415V, 5415H - 5415N, 5420, 5420N, 5500, 5500N, 5510, 5510N, 5515, 5515F - 5515HC - 5515V, 5520, 5520N, 5605, 5615, 5615F - 5615V, 5705, 5715, 5715HC, 7600, 7610, 7700, 7710, 7800, 7810, 820, 830, 840, 930, 930VU, 940, 940V	AT13740, AT27653
11290	LANDINI	10000, 10000S, 12500, 13000, 14500, 3000R, 3000RV, 4000/DI, 4000R, 4000S, 4500R, 5000DT, 5000R, 5000R-N, 5000R-S, 5000S, 5500, 5505, 5830, 5840, 5860, 5870, 6000, 6000S, 6030, 6040, 6060, 6070, 6500, 6505, 6550, 6830, 6840, 6870, 6880, 7000S, 7500, 7505, 7550, 7830, 7860, 7870, 7880, 8000DT, 8000R, 8500, 8550, 8830, 8860, 8880, 9500, 9880, 9880HC, ADVANTAGE 55F-55L-55V, ADVANTAGE 60F-60L, ADVANTAGE 65L-65LP-65V, ADVANTAGE 75L-75LP-75V, BLIZZARD:50, BLIZZARD:60, BLIZZARD:65, BLIZZARD:75, CINGOLATI: C10500, CINGOLATI: C4500, CINGOLATI: C4830, CINGOLATI: C5000, CINGOLATI: C5830, CINGOLATI: C6000, CINGOLATI: C6830, CINGOLATI: C7800, CINGOLATI: C7830, CINGOLATI: C4500, CINGOLATI: C4830, CINGOLATI: C5500, CINGOLATI: C5830, CINGOLATI: C6500, CINGOLATI: C7800, CINGOLATI: C8860, CINGOLATI: CF4830, CINGOLATI: CF5030, CINGOLATI: CF5830, CINGOLATI: CF6060, CINGOLATI: CF6830, FRUTTETI 530 F/L/V: 6030F/L, FRUTTETI 530 F/L/V: 4530V, FRUTTETI 530 F/L/V: 5530F/L, FRUTTETI 530 F/L/V: 5530V, FRUTTETI 530 F/L/V: 6030F/L, CLI, FRUTTETI 530 F/L/V: 6030V, FRUTTETI 530 F/L/V: 6030V, CLIMA, FRUTTETI 530 F/L/V: 6530F/L/V, FRUTTETI 530 F/L/V: 6530F/V, FRUTTETI 530 F/L/V: 6530L, FRUTTETI 530 F/L/V: 7530F, FRUTTETI 530 F/L/V: 7530F/L, FRUTTETI 530 F/L/V: 7530L, FRUTTETI 530 F/L/V: 8530F, FRUTTETI 530 F/L/V: 8530L, FRUTTETI 530 F/L/V: 8530L, CLIMA, FRUTTETI 560 F/L/V: 5560F/L, FRUTTETI 560 F/L/V: 5560V, FRUTTETI 560 F/L/V: 6060F/L, FRUTTETI 560 F/L/V: 6060V, FRUTTETI 560 F/L/V: 6060V, CLIM, FRUTTETI 560 F/L/V: 6560F/L, FRUTTETI 560 F/L/V: 7560F/L, FRUTTETI 560 F/L/V: 8560F/L, CL, FRUTTETI 560F/L/V: 6560V, FRUTTETI 560F/L/V: 8560 F/L, REX 60V - 65V, TREKKER 55F - 60F - 65F - 75F, TREKKER 70C - 70F - 70L, TREKKER 80C - 80F - 80L, TREKKER 90C - 90F - 90L, TREKKER CF75, VIGNETI 55V - 60V - 65V - 75V	2461104

Art./Ref.	Brand	Applicazione/Application	Rif. Orig./Orig. Ref.
11290	MASSEY FERGUSON	1004 - 1004T, 1007, 1014, 1024, 1080, 1085, 1100, 1104, 1105, 1114, 1130, 1134, 1200, 122, 1250, 130, 133, 134C - 134V, 135, 135V, 140, 145, 145S - 145V, 148, 150, 152, 152F - 152S - 152V, 154, 154C - 154F - 154S - 154V, 155, 158, 158F - 158S - 158V, 164TF - 164TS - 164TS, 165, 168, 168F - 168S, 174, 174C - 174F - 174S - 174V, 175, 175S, 178, 184, 184F - 184S, 185, 188, 194, 194C - 194F - 194S, 2205, 2210, 2220, 2230, 230, 233, 234C - 234CF - 234S, 235, 240, 244CF, 245, 25, 250, 253, 254, 254C - 254CF - 254S, 255, 2620, 2625, 263T, 2640, 264T - 264TCF - 264TS, 265, 2675, 2680, 2685, 2705, 2720, 2725, 273, 274, 274C - 274CF - 274S - 274SK, 275, 275E, 283, 284, 284S, 285, 290, 290E, 293, 294, 294C - 294S, 298, 3050, 3055, 3060, 3065, 3065S, 3070, 3075, 3080, 3085, 3090, 3095, 3115, 3120, 3120T, 3125, 3140, 3210FP - 3210GE - 3210SP, 3220AP - 3220FP - 3220GE, 3220SP, 3225AP - 3225FP - 3225GE, 3225SP, 3235AP - 3235FP - 3235GE, 3235SP, 3315, 3315F/FE - 3315GE - 3315S, 3315V, 3325, 3325F/FE - 3325GE - 3325V, 333, 3330, 3330F/FE - 3330GE - 3330S, 3330V, 3340, 3340F/FE - 3340GE - 3340S, 3340V, 334V, 3350, 3350F/FE - 3350GE - 3350S, 3355, 3355F/FE - 3355GE - 3355S, 340, 342, 35, 350, 352, 353, 353LX - 353S, 354AP - 354AQ, 354F - 354FP - 354FQ - 354GE, 354S - 354SP - 354SQ, 354V - 354VQ, 355, 356CF, 360, 3610, 362, 362N, 363, 3630, 3635, 363LX - 363S, 3645, 364AP - 364AQ - 364CF - 364F, 364FP - 364FQ - 364GE, 364S - 364SP - 364SQ, 364V - 364VQ, 365, 3650, 3655, 3660, 366CF, 367CF, 372, 372N, 373, 373LX - 373S, 374AP - 374AQ - 374F - 374FP, 374FQ - 374GE - 374H - 374S, 374SP - 374SQ - 374V - 374VQ, 375, 375E, 376C - 376CF - 376XCF, 377, 382N, 383, 383LX - 383S, 384AP - 384AQ - 384F - 384FP, 384FQ - 384GE - 384S - 384SP, 384SP - 384SQ - 384V - 384VQ, 387, 390, 390E, 390T, 393, 393LX - 393S - 393TLX, 394AP - 394C - 394F - 394FP, 394FQ - 394GE - 394H - 394S, 394SP - 394SQ - 394TAQ, 396, 396C - 396CF - 396CT, 397, 397T, 398, 399, 4215, 4220, 4225, 4225HV, 4235, 4235HV, 4240, 4245, 4245HV, 4255, 4255HV, 4260, 4265, 4270, 4315, 4320, 4325, 4325HV, 4335, 4335HV, 4345, 4345HV, 4355, 4355HV, 4360, 4365, 4370, 550, 560, 565, 575, 590, 592, 595, 6110, 6120, 6130, 6140, 6150, 6160, 6170, 6180, 6190, 6235, 6235HV, 6245, 6245HV, 6255, 6255HV, 6260, 6265, 6270, 6280, 6290, 65, 675, 690, 698, 698T, 699, 765, 8110, 8120, 8130, 8210, 8220, 825, 835, 865, FE35, TEA20, TED20, TEF20, TEH20	1851095M2, 1851764M1, 828140M1

**TERMOSTATI ADATTABILE**

THERMOSTATS ADAPTABLE  
THERMOSTAT ADAPTABLE  
THERMOSTAT PASSEND ZU  
THERMOSTATOS ADAPTABLE



Art./Ref.	Brand	Applicazione/Application	Rif. Orig./Orig. Ref.
42042	CASE	MXM120, MXM130, MXM135, MXM140, MXM150, MXM155, MXM165, MXM175, MXM180, MXM190	87800842, 87803664
09301		1300S, 1300SDT	8829564
09302	FIAT	100.90 - 100.90DT, 1000S, 110.90 - 110.90DT, 115.90 - 115.90DT, 1180, 1280, 130.90 - 130.90DT, 1300S, 1380, 140.90 - 140.90DT, 1580, 1880, 250, 300DT, 420, 440V-DT, 45.66S - 45.66S DT, 450, 470, 470 SP, 474, 50.66S - 50.66S DT, 50.86S V - 50.86S V DT, 50.86V - 50.86V DT, 540S-DT, 55.56 - 55.56 DT, 55.66S - 55.66S DT, 55.86F - 55.86F DT, 55.86S V - 55.86S V DT, 55.86V - 55.86V DT, 55.90 - 55.90 DT, 550, 56.66S - 56.66S DT, 566, 570V-DT, 60.56 - 60.56 DT, 60.66S - 60.66S DT, 60.86F - 60.86F DT, 60.86S V - 60.86S V DT, 60.86V - 60.86V DT, 60.90 - 60.90 DT, 60.93 - 60.93 DT, 60.94 - 60.94 DT, 600DT, 62.86F - 62.86F DT, 640, 65.56 - 65.56 DT, 65.66S - 65.66S DT, 65.90 - 65.90 DT, 65.93 - 65.93 DT, 65.94 - 65.94 DT, 666, 680, 70.56 - 70.56 DT, 70.66S - 70.66S DT, 70.86 V - 70.86 V DT, 70.86S V - 70.86S V DT, 70.90 - 70.90 DT, 72.86 F - 72.86 F DT, 72.86 LP - 72.86 LP DT, 72.93 - 72.93 DT, 72.94 - 72.94 DT, 766, 780, 80.66S - 80.66S DT, 80.90 - 80.90 DT, 82.86 F - 82.86 F DT, 82.86 LP - 82.86 LP DT, 82.93 - 82.93 DT, 82.94 - 82.94 DT, 85.90 - 85.90 DT, 88.93 - 88.93 DT, 88.94 - 88.94 DT, 880S, 90.90 - 90.90 DT, 980, F100 - F100DT, F110 - F110DT, F115 - F115DT, F120 - F120DT, F130 - F130DT, F140 - F140DT	4569187, 4610509, 4610510, 4630916, 4655782, 4674169, 4684390, 4703088, 4703089, 4703624, 4703625, 4823210, 4823211, 4823226, 98463637
09304		650, 650DT, 750, 750DT, 880, 880DT	8812039, 8819129, 8822893, 8826010, 8830331
42042		G170, G190, G210, G240	87800842
27769		1180, 1280, 1380, 140.90, 1580, 160.90, 180.90, 1880, 680, 780, 8430, 8630, 8830, 980	5114575
09302		3010S, 3300, 3400, 3435, 3500, 3550, 3830, 3935, 4010S, 4030, 4135, 4230, 4430, 4635, 4835, 5010S, 5635, 6635, 7635, 8210, 8430	4569187, 4823210, 4823211, 4823226, 98463637
21762	FORD	2000, 2100, 2110, 2120, 2150, 2300, 231, 233, 333, 335, 420, 2310, 2600, 2610, 2810, 2910, 3000, 3100, 3120, 3150, 3190, 3300, 3310, 3400, 3500, 3600, 3610, 3910, 4000, 4100, 4110, 4140, 4190, 4200, 4400, 4450, 4500, 4550, 4600, 4610, 5000, 5100, 5110, 5190, 5200, 5550, 5600, 5610, 5700, 5900, 6410, 6550, 6600, 6610, 6700, 6710, 6810, 7000, 7100, 7410, 7550, 7600, 7610, 7700, 7710, 8000, 8200, 8600, 8700, 9000, 9200, 9600, 9700, DEXTA, SUPER DEXTA	81805714, 81814071, 81822100, 83913835, C5NE8575D, C9NN8575A, C9NN8575C, D8NN8575AA

Art./Ref.	Brand	Applicazione/Application	Rif. Orig./Orig. Ref.
21763	FORD	2000, 2100, 2110, 2120, 2150, 2300, 231, 233, 333, 335, 420, 2310, 2600, 2610, 2810, 2910, 3000, 3100, 3120, 3150, 3190, 3300, 3310, 3400, 3500, 3600, 3610, 3910, 4000, 4100, 4110, 4140, 4190, 4200, 4400, 4450, 4500, 4550, 4600, 4610, 5000, 5100, 5110, 5190, 5200, 5550, 5600, 5610, 5700, 5900, 6410, 6550, 6600, 6610, 6700, 6710, 6810, 7000, 7100, 7410, 7550, 7600, 7610, 7700, 7710, 8000, 8200, 8600, 8700, 9200, 9600, 9700, MAJOR, POWER MAJOR, SUPER MAJOR	81859451, 83910123, 83916917, C9NN8575B, D8NN8575CA
21764		2000, 2100, 2110, 2120, 2150, 2300, 231, 233, 333, 335, 420, 2310, 2600, 2610, 2810, 2910, 3000, 3100, 3120, 3150, 3190, 3300, 3310, 3400, 3500, 3600, 3610, 3910, 4000, 4100, 4110, 4140, 4190, 4200, 4400, 4450, 4500, 4550, 4600, 4610, 5000, 5100, 5110, 5190, 5200, 5550, 5600, 5610, 5700, 5900, 6410, 6550, 6600, 6610, 6700, 6710, 6810, 7000, 7100, 7410, 7550, 7600, 7610, 7700, 7710, 8000, 8200, 8600, 8700, 9000, 9200, 9600, 9700	81821482, 83916916, C5NE8575A, C9NN8575A, D8NN8575BA
42042		2310, 2610, 2810, 2910, 3230, 3430, 3930, 4130, 4630, 3610, 3910, 4110, 4610, 4830, 5030, 5610S, 5640, 6610S, 4830N, 4830O, 5030O, 5110, 5610, 5900, 6410, 6610, 6610O, 6640, 6810S, 7740, 7010, 7610S, 6710, 6810, 7410, 7610, 7610O, 7710, 7810, 7810S, 7840, 7910, 8010, 8160, 8210, 8240, 8260, 8340, 8340, 8360, 8530, 8560, 8630, 8670, 8730, 8770, 8830, 8870, 8670A, 8770A, 8870A, 8970, 8970A, TW25, TW30, TW35, TW5, TW10, TW15, TW20	83916340, 87800842, 87802743, 87803664, D8NN8575FB
40549	LANDINI	1000, 1000S, 12500, 13000, 14500, 16000, 16550, 3000/RV, 3000R, 4000/DT, 4000R, 4000S, 4500R, 4530F, 4530L, 4530V, 4560F, 4560L, 4560V, 5000/DT, 5000/S, 5000R, 5000R-N, 5500, 5530F, 5530L, 5530V, 5560F, 5560L, 5560V, 5830, 5840, 5860, 5870, 6030, 6030F, 6030L, 6030V, 6040, 6500, 6530F, 6530L, 6530V, 6550, 6560F, 6560L, 6560V, 6830, 6840, 6860, 6860V, 6870, 6880, 6880VM, 7500, 7505, 7530F, 7530L, 7550, 7560F, 7560L, 7560V, 7830, 7860, 7860HC, 7870, 7870V, 7880, 7880VM, 8500, 8530F, 8530L, 8530V, 8550, 8560L, 8560V, 8830, 8860, 8860HC, 8870, 8870V, 8880, 8880HC, ADVANTAGE 55F, 55FP, 55GE, ADVANTAGE 55GT, 55GTP, 55L, 55LP, ADVANTAGE 65F, 65FP, 65GE, 65GT, ADVANTAGE 65GTP, 65L, 65LP, ADVANTAGE 75F, 75FP, 75GE, 75GT, ADVANTAGE 75GTP, 75L, 75LP, ADVANTAGE 85F, 85FP, 85GE, 85GT, ADVANTAGE 85GTP, 85L, 85LP, BLIZZARD 50 - 65 - 75 - 85, CINGOLATI: CF5830, CINGOLATI: CF6830, CINGOLATI: C4500, CINGOLATI: C4830, CINGOLATI: C5000, CINGOLATI: C5500, CINGOLATI: C5830, CINGOLATI: C6500, CINGOLATI: C6830, CINGOLATI: C7800, CINGOLATI: C7830, CINGOLATI: C8860, CINGOLATI: CF4830, CINGOLATI: CF5030, CINGOLATI: CF6030, GLOBUS 50, GLOBUS: 50, LEGEND 130BLU - 160BLU, POWER 115BLU-130BLU-160BLU, REX 90GE, TREKKER 50F - 55F - 65F - 70F, TREKKER 75 - 85 NG TIER3, TREKKER 75F - 85F, TREKKER 80F, TREKKER 95C, TREKKER C75 - C85, TREKKER CF75 - CF85, VIGNETI 55V, 65V, 75V, VIGNETI FOOTSTEP 65V - 75V	2485635, 2485645, 2485648, 2485653, 2485666
40553		3000R - 3000RV, 4560V, 5000 SPECIAL, 5000DT - 5000R - 5000R-N, 5500, 5530F, 5530L, 5530V, 5560F, 5560L, 5560V, 5830, 5840, 5860, 5870, 6030, 6030F, 6030L, 6030V, 6040, 6500, 6530F, 6530L, 6530V, 6550, 6560F, 6560L, 6560V, 6830, 6840, 6860, 6860V, 6870, 6880, 6880VM, 7000 SPECIAL, 7500, 7505, 7530F, 7530L, 7550, 7560F, 7560L, 7830, 7860, 7860HC, 7870, 7870V, 7880, 7880VM, 8500, 8530F, 8530L, 8550, 8560F, 8560L, 8830, 8860, 8870, 8870V, 8880, 8880HC, ADVANTAGE 55F, 55FP, 55GE, ADVANTAGE 55GT, 55GTP, 55L, ADVANTAGE 55LP, 65F, 65FP, ADVANTAGE 65GE, 65GT, 65GTP, ADVANTAGE 65L, 65LP, 75F, 75FP, ADVANTAGE 75GE, 75GT, 75GTP, ADVANTAGE 75L, 75LP, 85F, ADVANTAGE 85FP, 85GE, 85GT, ADVANTAGE 85GTP, 85L, 85LP, BLIZZARD :50, BLIZZARD :85, BLIZZARD:65, BLIZZARD:75, CINGOLATI :C4500, CINGOLATI :C4830, CINGOLATI :C5000, CINGOLATI :C5500, CINGOLATI :C5830, CINGOLATI :C6830, CINGOLATI :C7800, CINGOLATI :C7830, CINGOLATI :C8860, CINGOLATI: C6500, CINGOLATI: CF 4830, CINGOLATI: CF 5030, CINGOLATI: CF 5830, CINGOLATI: CF 6830, FOOTSTEP 65V - 75V, GLOBUS 50, LARGE 12500 - 14500, LARGE 13000 - 16000 - 16550, LEGEND 130BLU - 160BLU, POWER 115BLU-130BLU-160BLU, REX 90GE, TREKKER 50F - 55F - 65F - 70F, TREKKER 75F - 85F, TREKKER C75 - C85, TREKKER CF75 - CF85, TREKKER NG 80F, TREKKER NH TIER 2 95C, VIGNETI 55V - 65V - 75V	2485644, 2485657, 2485659
40558		10000, 10000S, 12500, 13000, 14500, 16000, 16500, 6060, 6060F, 6060L, 6060V, 6070, 7860, 8860, 9060, 9080, 9080HC, 9500, 9550, 9880, 9880HC, ADVANTAGE 60F, 60FP, 60GE, ADVANTAGE 60GT, 60GTP, 60L, ADVANTAGE 60LP, ADVANTAGE 95GT, L95GT, ATLANTIS 75, ATLANTIS 85, ATLAS:75, ATLAS:85, BLIZZARD:60, BLIZZARD:95, CF6060, FOOTSTEP 60V, GLOBUS 55 - 60 - 70, LEGEND 115 NG, LEGEND NH TDI 130BLU-160BLU, LEGEND:105, LEGEND:115, LEGEND:130, LEGEND:145, LEGEND:165, POWER 115BLU-130BLU-160BLU, REX NEW TIER 2 95GTP, TREKKER 60F, TREKKER C95, TREKKER CF60, TREKKER NG TIER 3 95, VIGNETI 60V	2485605, 2485613
40549	MASSEY FERGUSON	1004, 1014, 1080, 1085, 1100, 1104, 1105, 1130, 1135, 1200, 122, 130, 133, 134C, 134V, 135, 140, 145, 145S, 145V, 148, 150, 152, 152F, 152S, 152V, 154, 154C, 154F, 154S, 154V, 2205, 230, 233, 234C, 234CF, 234S, 235, 240, 244CF, 245, 25, 250, 250X, 250X ADVANCED, 253, 254, 254C, 254CF, 254S, 255, 263T, 264T, 264TFC, 264TS, 265, 265 ADVANCED, 275, 275 ADVANCED, 283, 283 ADVANCED, 290X, 290X ADVANCED, 298, 30, 3210FP, 3210GE, 3210SP, 333, 334V, 340, 342, 35, 350, 352, 353, 353LX, 353S, 354AP, 354AQ, 354F, 354FQ, 354GE, 354S, 354SP, 354SQ, 354V, 354VQ, 355, 356CF, 360, 362, 362N, 372N, 382N, 415, 425, 435, 440, 445, 550, 592, 595, 675, 690, 698, 825, 835, TEF20	1446165M91, 828139M1
40553		165, 168, 168F, 168S, 174, 174C, 174F, 174S, 174V, 175, 175S, 178, 184, 184F, 184S, 185, 188, 194, 194C, 194F, 194S, 265, 273, 274, 274C, 274CF, 274S, 274SK, 275, 275E, 283, 284, 284S, 285, 290, 290E, 294, 294C, 294S, 3220AP, 3220FP, 3220GE, 3220SP, 3225AP, 3225FP, 3225GE, 3225SP, 3235AP, 3235FP, 3235GE, 3235SP, 367CF, 373, 373LX, 373S, 374AP, 374AQ, 374F, 374FP, 374FQ, 374GE, 374H, 374S, 374SP, 374SQ, 374V, 374VQ, 375E, 376C, 376CF, 376XCF, 377, 383, 383LX, 383S, 384AP, 384AQ, 384F, 384FP, 384FQ, 384GE, 384S, 384SP, 384SQ, 384V, 384VQ, 387, 390E, 393, 393LX, 393S, 394AP, 394AQ, 394C, 394F, 394FP, 394FQ, 394GE, 394H, 394S, 394SP, 394SQ, 396C, 396CF, 397, 565, 575, 590, TED20 - TEH20	1446127M91, 826306M1
40558		1004T, 1007, 1014, 1024, 1100, 1104, 1105, 1114, 1130, 1134, 1135, 1200, 1250, 2620, 2625, 2640, 2645, 2675, 2680, 2685, 2705, 2720, 2725, 275E, 290E, 297, 299, 3050, 3055, 3060, 3065, 3065S, 3070, 3075, 3080, 3085, 3090, 3095, 3115, 3120, 3120T, 3125, 3140, 3610, 3630, 3635, 3645, 365, 3650, 3655, 3660, 375, 375E, 390, 390/T, 390E, 393TLX, 394TAQ, 396, 396CT, 397T, 398, 399, 4225, 4225HV, 4235, 4235HV, 4240, 4245, 4245HV, 4255, 4255HV, 4260, 4270, 4360, 4370, 5275, 5285, 5290, 5300, 5310, 5320, 6110, 6120, 6130, 6140, 6150, 6160, 6170, 6180, 6190, 630, 640, 650, 660, 680, 698T, 699, 8110, 8120, 8130	1447384M1
09302	NEW HOLLAND	L60, L65, L75, L85, L95, TD55D, TD60D, TD65D, TD70D, TD60, TD70, TD80, TD90, TD95, TD65F, TD75F, TD85F, TD75D, TD80D, TD85D, TD90D, TD95D, TK100A, TK65F, TK65V, TK70FA, TK70VA, TK75F, TK75FA, TK75M, TK75MA, TK75V, TK75VA, TK76, TK76M, TK80A, TK80MA, TK85, TK85M, TK90A, TK90MA, TK95M, TL70, TL80, TL90, TL100, TN55, TN65, TN70, TN75, TN55D, TN65D, TN70D, TN75D, TN55S, TN65S, TN70S, TN75S, TN55V, TN65V, TN75V, TN60A, TN70A, TN75A, TN60DA, TN70DA, TN75DA, TN60SA, TN70SA, TN75SA, TN60VA, TN70VA, TN75VA, TN95VA, TN65F, TN70F, TN75F, TN65N, TN70F, TN70NA, TN95NA, TN75F, TN75FA, TN75FA, TN85FA, TN95FA, TN75N, TN75NA, TN80F, TN80F, TN90F, TN95F, TN90F, TN95F, TN95F	98463637

Art./Ref.	Brand	Applicazione/Application	Rif. Orig./Orig. Ref.
42042	NEW HOLLAND	75TLB, 95TLB, LB110, LB115 - LB115B, LB115CP, LB75B, LB85, LB90, LB95, M100, M115, M135, M160, TC54 - TC56, TF76, TM110, TM115, TM120, TM125, TM130, TM135, TM140, TM150, TM155, TM165, TM175, TM180, TM190, TR86 - TR88 - TR89, TR96 - TR97 - TR98 - TR99, TS100, TS110, TS115, TS80, TS90, TV140, TX62 - TX63 - TX64 - TX65, TX66 - TX67 - TX68	83916340, 87800842, 87802743, 87803664

**CINGHIE ADATTABILI**

CEINTURES ADAPTABLE

BELTS ADAPTABLE

GÜRTEL PASSEND ZU

CINTURONES ADAPTABLE

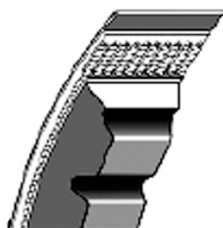

Art./Ref.	Brand	Note/Notes	Applicazione/Application	Rif. Orig./Orig. Ref.
27471	CASE	Cinghia alternatore Con aria condizionata/ Alternator fan belt - With air conditioning	JX55 - JX60 - JX65 - JX70, JX75 - JX80 - JX85, JX90 - JX95	5140009
40649		Cinghia /Belt	353 - 383 - 423 - 453, 433 - 533 - 633 - 733 - 833, 475 - 533 - 654 - 724 - 824, 644 - 744, 743 - 743XL, 745S - 745XL, 844 - 844S - 844XL, D323	3055715R1, 3116685R1
42951		Cinghia pompa acqua/Water pump fan belt	JX100U - JX1060C - JX1070C, JX1075C - JX55 - JX60 - JX65, JX70 - JX70U - JX80U - JX90U	98432119, 98473705
42952		Cinghia pompa acqua/Water pump fan belt	JX55 - JX60 - JX65 - JX70, JX75 - JX80 - JX85, JX90 - JX95	5140010
12860		Cinghia alternatore Con aria condizionata/ Alternator fan belt - With air conditioning	JX55, JX60, JX65, JX70, JX75, JX80, JX85, JX90, JX95	K605030, K903050
12861			383,423,453 (DYNAMO 11A), 440,540,640,740,840,940, 743, 745,845,856, 844S, D323	3144678R1
12863			1294,1394,1494, DGD4, JX100, JX1060, JX1075, JX55, JX60, JX65, JX70, JX80, JX90	K68073
27467		Coppia cinghie/Pair of fan belts	JX1060C, JX1070C, JX1075C, JX60, JX70, JX80, JX85, JX90, JX95, JX70U, JX80U, JX90U, JX100U	4796328, 500369112
12860	DAVID BROWN	Cinghia alternatore Con aria condizionata/ Alternator fan belt - With air conditioning	1210, 1212, 850, 880, 890, 990, 950, 990, 995, 996	K903050
12863			1200, 1210, 1212, 1410, 1412, 1490, 1494, 850, 880, 885, 1190, 1290, 1390, 990, 995, 996, 1194, 1294, 1394	K68073
12860	DEUTZ	Cinghia alternatore Con aria condizionata/ Alternator fan belt - With air conditioning	10006, 8006, AGROPRIMA 4.31, AGROXTRA 3.57, 4.07, 4.17, DX3.10SC, DX3.30SC, DX3.50SC, DX3.10VC, DX3.30VC, DX3.50VC, DX3.60SC, DX3.65SC, DX3.70SC, DX3.60VC, DX3.65VC, DX3.70VC, DX3.75VC, DX3.90VC, DX3.80SC, DX3.90SC, DX4.10, DX4.11, DX4.30, DX6.10, DX6.30, DX85, DX90, DX110, DX120	01175765, 01179566, 02235180, 02235264
12863			2807, 3006, 3607, DX36	02231579, 02235181
12863	FENDT		5S, 106LS/LSA/S/SA, F345GTM, F360GTF, F360GTH	X696615001000
27467		Coppia cinghie/Pair of fan belts	102, 102LS, 102LSA, 102S, 102SA, 103, 103LS, 103LSA, 103S, 103SA, 104LS, 104LSA, 104S, 104SA, 105, 105LS, 105LSA, 105S, 105SA, 106LS, 106LSA, 106S, 106SA, 108LS, 108LSA, 108S, 108SA, 200S, 200SA, 200V, 200VA, 201S, 201SA, 203P, 203P/II, 203PA, 204P, 204PA, 204V, 204VA, 205P, 205PA, 240S, 250K, 250KA, 250LE, 250S, 250SA, 250V, 260P, 260PA, 260S, 260SA, 260V, 270PA, 270V, 270VA, 275SA, 275V, 275VA, 280P, 280PA	X696615000000, X696615200000
40660		Cinghia/Belt	300LSA, 303LS, 304LS, 304LSA, 305LS, 305LSA, 306LS, 306LSA, 307, 307C, 307LS, 307LSA, 308, 308C, 308LS, 308LSA, 309, 309C, 309LS, 309LSA, 310, 310LSA, 311, 311LSA, 312, 312LSA	X696616800000
12860	FIAT	Cinghia alternatore Con aria condizionata/ Alternator fan belt - With air conditioning	1000, 1180, 880-5, 250, 300DT, 450, 440V DT, 640, 300, 350, 420, 446, 450, 466, 480, 500, 540, 550, 566, 570, 600, 640, 55.46, 65.46DT, 70.56, 65.56, 62.86, 70.86, 72.86, L60, L65, L85, 666, 670, 766, 900, 1000, 70.76F DT, 80.76F DT, 72.94, 82.94, 88.94	4615470, 4615473, 4618920, 4620361, 4620363, 4624736, 4624737, 4688853, 4796327, 920016251, 98473706

Art./Ref.	Brand	Note/Notes	Applicazione/Application	Rif. Orig./Orig. Ref.
12861	FIAT		650, 750, 850S	44010698, 8818153
12863			100.90,110.90,115.90,130.90, 140.90, 580,880-5,980,1180, 60.93, 60.94DT, 65.93, 72.93, 680, 780, 55.90, 60.90, 65.90, 70.90, 80.90, 85.90DT, 72.94, 82.93, 88.93, 65.94, 82.94, 88.94, 90.90, L60,L65,L75,L85,L95	4696714, 4796650, 4796652
14959			140.90 - 160.90 - 180.90	98490936
27467		Coppia cinghie/Pair of fan belts	110.90, 115.90, 130.90, 1180, 1180DT, 580, 680, 780, 65-94, 65-94DT, 72-94, 72-94DT, 82-93, 82-93DT, 88-93, 88-93DT, 82-94, 82-94DT, 88-94, 88-94DT, 880-5,980, 90.90, 880S, 980, 1180, 100.90	4688855, 4796325, 4796328, 500369112
27468		Cinghia/Belt	50.86,55.86,60.86,62.86, 55.56L, 45.66S, 50.66S, 45.76V, 55.65,60.65,55.75,60.75,88.85, 55.76V/F DT, 60.76V/F DT	4809679, 4809680, 5186232, 98437415
27471		Cinghia alternatore Con aria condizionata/ Alternator fan belt - With air conditioning	65.94 - 65.94DT, 72.94 - 72.94DT, 82.94 - 82.94DT, 88.94 - 88.94DT	5140009
40660		Cinghia/Belt	1580,1880, 160-55,160-90,180-90	4696442, 4796442
42952		Cinghia pompa acqua con aria condizionata/Water pump fan belt with air conditioning	65.94 - 65.94DT, 72.94 - 72.94DT, 82.94 - 82.94DT, 88.94 - 88.94DT	5140010

12860	FORD	Cinghia alternatore Con aria condizionata/ Alternator fan belt - With air conditioning	3010S - 4010S - 5010S, 4030 - 4230 - 4430, 4635 - 4835 - 5635, 6635 - 7635	4796327, 98473706
16899		Cinghia pompa acqua con aria condizionata/Water pump fan belt with air conditioning	2310, 2600, 2610, 2810, 2910, 3600, 3610, 3910, 4100, 4110, 4600, 4610, 5110, 5600, 5610, 5700, 6410, 6600, 6610, 6700, 6710, 6810, 7410, 7600, 7610, 7700, 7710, 7810	80443634, 81843821, 83910824, D6NN8620AA
27468		Cinghia/Belt	3435,3935, 3830,4030	4809680
27471		Cinghia alternatore Con aria condizionata/ Alternator fan belt - With air conditioning	4635, 4835, 5635, 6635, 7635	5140009
41988		Cinghia pompa acqua/Water pump fan belt	DEXTA, MAJOR, POWER MAJOR, SUPER DEXTA, SUPER MAJOR	81718146, E1ADKN8620C
41995		Cinghia pompa acqua/Water pump fan belt	2310 - 2610 - 2810 - 2910, 2600 - 8000, 3230 - 3430 - 3930 - 4130, 3600 - 4100 - 4600 - 5600, 3610 - 3910 - 4110 - 4610, 4630 - 4830 - 5030, 5110 - 5610 - 5610S - 6410, 5700 - 6600 - 6700, 6610 - 6610S - 6710 - 6810S, 7010 - 7610S - 7810S - 7910, 8010 - 8210, 8200 - 8600	81822583, 81836785, 81845757, 83976999, 87800127, D3NN10C318C
42013		Cinghia alternatore Con aria condizionata/ Alternator fan belt - With air conditioning	2310 - 2610 - 2810 - 2910, 2600, 3600 - 4100 - 4600, 3610 - 3910 - 4110 - 4610	83908004, 86518903, D6NN10C318A
42015		Cinghia alternatore Con aria condizionata/ Alternator fan belt - With air conditioning	2310 - 2610 - 2810 - 2910, 2600, 3600 - 4100 - 4600 - 5600, 3610 - 3910 - 4110 - 4610, 5110 - 5610 - 6410 - 6610, 5700 - 6600 - 6700, 6710 - 6810 - 7410, 7600 - 7700, 7610 - 7710 - 7810	83949803, E4NN-10C318AA
42017		Cinghia pompa acqua/Water pump fan belt	5110, 5600, 5610, 5700, 6410, 6600, 6610, 6700, 6710, 6810, 7410, 7600, 7610, 7700, 7710, 7810	83963768, 86514611, E7NN8620AA
42022		Cinghia pompa acqua/Water pump fan belt	5640 (NO AC), 6640 (NO AC)	81865048, 82850751, F0NN8620FA
42023		Cinghia pompa acqua con aria condizionata/Water pump fan belt with air conditioning	5640(AC), 6640(AC), 7740(AC), 7840(AC), 8240(AC), 8340(AC)	81865047, 82850752, 86518908, 87309963, F2NN8620AA
42024		Cinghia pompa acqua/Water pump fan belt	7740(NO AC), 7840(NO AC), 8240(NO AC), 8340(NO AC)	81865046, 82850750, 87316556, F0NN-8620GA
42030		Cinghia pompa acqua/Water pump fan belt	TW30, TW35, 7810, 78100, 7910, 8210, 8530, 8630, 8700, 8730, 8830, 9700, 9000, 9200, 9600, 9700, TW5, TW10, TW15, TW20, TW25	89625879, 9625879, E9NN10C318AB
42031		Cinghia alternatore/Alternator fan belt	7910 - 8210, 8530 - 8630 - 8730 - 8830, TW10 - TW15 - TW20 - TW25, TW30 - TW35 - TW5	83912574, D8NN-10C318AA
42951		Cinghia pompa acqua/Water pump fan belt	4635, 4835, 5635, 6635, 7635	98432119, 98473705
42952		Cinghia pompa acqua con aria condizionata/Water pump fan belt with air conditioning	4635, 4835, 5635, 6635, 7635	5140010

12860	LAVERDA	Cinghia alternatore Con aria condizionata/ Alternator fan belt - With air conditioning	3300,3400,3500,3550,3650,3750	4796327
42023		Cinghia pompa acqua con aria condizionata/Water pump fan belt with air conditioning	L411,L413,L416,L516	87309963
LV344311226		Cinghia trasmissione /Transmission belt		3443112260
LV3404351550		Cinghia/Belt		3404351550

Art./Ref.	Brand	Note/Notes	Applicazione/Application	Rif. Orig./Orig. Ref.
<b>40646</b>	<b>LANDINI</b>	Cinghia /Belt	16000,16500, ADVANTAGE CABINATO: 65L, ADVANTAGE CABINATO:55F, ADVANTAGE CABINATO:55GT, ADVANTAGE CABINATO:55L, ADVANTAGE CABINATO:60F, ADVANTAGE CABINATO:60GT, ADVANTAGE CABINATO:60L, ADVANTAGE CABINATO:65F, ADVANTAGE CABINATO:65GT, ADVANTAGE CABINATO:75F, ADVANTAGE CABINATO:75GT, ADVANTAGE CABINATO:75L, ADVANTAGE CABINATO:85F, ADVANTAGE CABINATO:85GT, ADVANTAGE CABINATO:85L, ADVANTAGE FOOT STEP:55FP-LP-GT, ADVANTAGE FOOT STEP:60FP-LP-GT, ADVANTAGE FOOT STEP:65FP-LP-GT, ADVANTAGE FOOT STEP:75FP-LP-GT, ADVANTAGE FOOT STEP:85FP-LP-GT, BLIZZARD:50, BLIZZARD:60, BLIZZARD:65, BLIZZARD:75, BLIZZARD:85, CINGOLATI C.F: 4830, CINGOLATI C.F: 5030, CINGOLATI C.F: 5830, CINGOLATI C.F: 6030, CINGOLATI C.F: 6060, CINGOLATI C.F: 6830, CINGOLATI C6830, CINGOLATI C7830, CINGOLATI C8860, FRUTTETI 5560 F/L/V, FRUTTETI 560 F/L/V:4560V, FRUTTETI 6060 F/L/V, FRUTTETI 6560F, FRUTTETI 6560L/V, FRUTTETI 7560F, FRUTTETI 7560L, FRUTTETI 8560F, FRUTTETI 8560L, FRUTTETI 8530F, GLOBUS:50, REX CABINATI:60, REX FOOT STEP :60FP-LP-GE, SERIE 60 NEW: 5860, SERIE 60:5860, SERIE 60:6060, SERIE 60:6860, SERIE 60:7860, SERIE 60:7860HC, SERIE 60:8860, SERIE 60:8860HC, SERIE 70:5870, SERIE 70:6070, SERIE 70:6870, SERIE 70:7870, SERIE 70:8870, SERIE 80: 7880, SERIE 80:6880, SERIE 80:8880, SERIE 80:8880HC, TREKKER C.F: CF55, TREKKER C.F: CF60, TREKKER C.F: CF65, TREKKER C.F: CF70, TREKKER C.F: CF75, TREKKER C.F: CF85, TREKKER C: C75, TREKKER C: C85, VIGNETI CABINA V.Q: 60V, VIGNETI CABINA V.Q: 65V, VIGNETI CABINA V.Q: 75V, VIGNETI CABINA V.Q:55V, VIGNETI FOOT STEP:55V, VIGNETI FOOT STEP:60V, VIGNETI FOOT STEP:65V, VIGNETI FOOT STEP:75V, VIGNETI REX CABINATI:60V, VIGNETI REX CABINATI:65V	1693746M1, 1810548M1, 1851749M1, 1851751M1, 2614B042, 2614B142, 2614B560, 2614B642, 3637595M1
<b>40658</b>		Cinghia/ Belt	16000, 16500	2614B667, 2614B677
<b>40646</b>	<b>MCCORMICK</b>	Cinghia/Belt	F60,F75,F80,F85,T70,T80,T90, T100,V60,V65	2614B042, 2614B142, 2614B560, 2614B642
<b>12861</b>	<b>MASSEY FERGUSON</b>		1014, 20B,20C,20E,20F,30E,30H,40E, 375E,390E, 50E,5EX,50HS,50HT,50HX,50HXS, 60HS	1687531M1, 2614B154, 2614B654, 3639686M1, 531371M1
<b>12863</b>			362N,372N,382N (AIRCOND.)	3761507M91
<b>40626</b>		Cinghia/ Belt	230 - 240 - 250, 4215 - 4220 - 4225HV, 4235HV - 4245HV - 4255HV, 4315 - 4320	1688988M1, 2641B050
<b>40646</b>		Cinghia/ Belt	2640,2645,2680,2685,2725, 3225,3235, 333,334,340,342,350,352,353, 35 (<304621), 354,355,356,360,363,364,366, 367,373,374,376,377,383,384, 387,393,394,396,397,3210,3220, 65 (<241900), 765 (<241900)	1693746M1, 1810548M1, 1851749M1, 1851751M1, 2614B042, 2614B142, 2614B560, 2614B642, 3637595M1
<b>40647</b>		Cinghia/ Belt	133,135,140,145,152,165,185, 148, 230, 65(>2419001), 154,164,174,184,194, 188,234,253,254,263,264,273, 194C,244,264, 274,283,284,293,294,333,353, 340,342,350,352,355,360,362, 35 (>304622), 133, 135, 140, 35,765,2205,134C,154C,174C, 354,363,364,373,374,377,383, 356,366,367,376, 372,382,396,3125,3645, 384,387,393,394,397, 765(>2419001), 155, 158, 165	1447784M91, 2612418, 2612419, 2614B043, 2614B143, 2614B145, 2614B645, 3637597M1, 890982M1, 962184M1
<b>40649</b>		Cinghia/ Belt	235 - 240 - 245 - 250 - 255, 550	1876670M1
<b>40650</b>		Cinghia/ Belt	230 - 275E - 290E, 240(>513538), 250, 375E - 390E, 550(>6206621)	1687531M1, 2612465
<b>40655</b>		Cinghia/ Belt	365, 375, 390, 390T, 398, 698T	1693745M1
<b>40658</b>		Cinghia/ Belt	1100 - 1300, 2640 - 2675 - 2680 - 2685, 2705 - 2720 - 2725, 3085 - 3095, 3115, 3630 - 3650, 6160 - 6170 - 6180, 8240 - 8240XTRA, 8250 - 8250XTRA, 8260	3040949M1, 3040950M91, 3045111M91, 3386190M91, 3617180M91
<b>40659</b>		Cinghia/ Belt	265 - 275 - 285 - 290, 3050, 575 - 590, 675 - 690	2641B559, 3038899M1, 3387562M2, 3581611M1
<b>40660</b>		Cinghia/ Belt	3050,3055,3060,3065,3070,3080, 3060, 3065, 3070	3383044M91
<b>40661</b>		Cinghia/ Belt	1114 - 1134, 2640 - 2645, 3080 - 3090, 3610, 396 - 399, 8260 - 8260XTRA	1447419M91, 2612481, 2614670, 2614B170, 3381364M91, 3614706M92

Art./Ref.	Brand	Note/Notes	Applicazione/Application	Rif. Orig./Orig. Ref.
12860	NEW HOLLAND	Cinghia alternatore con aria condizionata/ Alternator fan belt With air conditioning	L60,L65,L75,L85,L95, L75,L95,TL70,TL80,TL90,TL100, TD55D,TD60D,TD70D,TD75D,TD80D, TD85D,TD90D,TD95D, TL70,TL80,TL90,TL100, TN55,TN65,TN70,TN75, VN240,VN260	98473706
16899		Cinghia pompa acqua con aria condizionata /Water pump fan belt with air conditioning	TF42,TF44,TF46,TX30,TX32,TX36	80443634
27467		Coppia cinghie/Pair of fan belts	TD60D,TD70D,TD80D,TD90D,TD95D, TD80,TD90,TD95, TL70,TL80,TL90,TL100, TN65F, TN70F	4796328, 500369112
27468		Cinghia / Belt	TL70,TL80,TL90,TL100	4809680
27471		Cinghia alternatore con aria condizionata/ Alternator fan belt With air conditioning	L60 - L65 - L75 - L85 - L95,TD55D - TD60D - TD65D - TD70D,TD75D - TD80D - TD85D, TD90D - TD95D, TL70 - TL80 - TL90 - TL100	5140009
42017		Cinghia pompa acqua/Water pump fan belt	L779,L783,L785	86514611
42022		Cinghia pompa acqua/Water pump fan belt	TS100 (NO AC), TS80, TS90 (NO AC)	81865048, 82850751
42023		Cinghia pompa acqua con aria condizionata /Water pump fan belt with air conditioning	TC52,TC54,TC56, TS115(AC), TS90(AC), TS100(AC), TS110(AC)	81865047, 86518908, 87309963
42024		Cinghia pompa acqua/Water pump fan belt	TS110 (NO AC), TS115 (NO AC)	81865046, 82850750, 87316556
42951		Cinghia pompa acqua/Water pump fan belt	L60 - L65 - L75 - L85 - L95, TD60 - TD70 - TD60D - TD70D, TK100A, TK65F, TK65V, TK70FA, TK70VA, TK75F, TK75FA, TK75M, TK75MA, TK75V, TK75VA, TK76, TK76M, TK80A, TK80MA, TK85 - TK85M, TK90A, TK90MA, TK95M, TL65 - TL70 - TL80, TL90 - TL100, TN55 - TN65 - TN70 - TN75, TN55D - TN65D - TN70D - TN75D, TN55S - TN65S - TN70S - TN75S, TN60A - TN70A - TN75A, TN60SA - TN70SA - TN75SA, TN65F - TN70F - TN75F, TN65F - TN70F - TN75F - TN75FA, TN75FA - TN85FA - TN95FA, TN80F - TN90F - TN95F, TN80F - TN90F - TN95F - TN95FA	98432119, 98473705
42952		Cinghia pompa acqua con aria condizionata /Water pump fan belt with air conditioning	L60 - L65 - L75 - L85 - L95, TD55D - TD60D - TD65D - TD70D, TD75D - TD80D - TD85D, TD90D - TD95D, TL70 - TL80 - TL90 - TL100	5140010
<b>ORIGINALI</b> NH181055C1		Cinghia/Belt		181055C1
<b>ORIGINALI</b> NH191290C1		Cinghia/Belt		191290C1
<b>ORIGINALI</b> NH1347160C1				1347160C1
12861	PERKINS		A6.354.1	2614B154, 2614B654
40626		Cinghia/Belt	1004.4T, 903-27, 903-27T, A4.236, A4.41, AD3.152, AT4.236	2641B050
40646		Cinghia/Belt	AD3.152,A6.354.4,AT6.354.4, T6.354.4	2614B042, 2614B142, 2614B560, 2614B642
40650		Cinghia/Belt	A4.236, A4.248, A4.41, A6.372.4, AD3.152, AT6.354.4	2612465
40655		Cinghia/Belt	A4.236, A4.248, AT4.236	1693745M1
40658		Cinghia/Belt	1006.6,A6.354.4,1006.6T, AT6.354.4,A6.354.1	2614B667, 2614B677
40659		Cinghia/Belt	A4.236, A4.248	2641B559
40661		Cinghia/Belt	1006.6, A6.354.4, AT6.354.4	2612481, 2614670, 2614B170
12863	STEYR		360,370,375	K68073
27467		Coppia cinghie/ Pair of fan belts	KOMPAKT 360/370/375	4796328
42951		Cinghia pompa acqua /Water pump fan belt	360 - 370 - 375	98432119, 98473705
12861	VALTRA		311DS,320D,320DS,420D,420DS, 365,465,505,565,600,665,700, 6000,6100,6300,6400,6600	V684121325



# 1.7.21 Alimentazione

Alimentation



## Ricambi & accessori per macchine agricole

### SPARE PARTS & ACCESSORIES FOR AGRICULTURAL MACHINE

Tutti gli articoli della presente sezione, prodotti da AMA SPA e/o da terzi per conto di AMA, sono adattabili ("non originali") alle marche indicate ai sensi di quanto previsto dal REG. CE n. 1400/2002. I diritti sui marchi citati appartengono ai legittimi proprietari ed il loro uso ha l'esclusiva finalità di consentire all'utilizzatore la comparazione dei diversi prodotti. All items of this section, manufactured by AMA SPA and/or any third party on behalf of AMA, are adaptable ("non-original") to the brands listed under the provisions of the REG. CE n. 1400/2002. The rights on the trademarks belong to their respective owners and their usage is only aimed to allow the user to compare different products.

**CORPO DISTRIBUTORE LEVA CORTA SINISTRA**

DISTRIBUTEUR LEVIER COURT, GAUCHE  
 SHORT LEFT LEVER DISTRIBUTOR  
 KURZE, LINKE HEBEL STEUERGERÄT  
 CUERPO DISTRIBUIDORE PALANCA CORTA IZQUIERDA



**Note:** Per prese a pressione supplementari del sollevatore adattabili a trattori FIAT "SERIE ORO".

**Notes:** Additional valve suitable FIAT tractor "SERIE ORO".

Art./Ref.	Note/Notes	Brand	Applicazione/Application	Rif. Orig./Orig. Ref.
<b>04281</b>	Leva corta sinistra/Short left lever	<b>FIAT</b>	300, 400, 420, 450, 460, 480, 500, 540, 550, 605, 640	588771

**LEVA LUNGA DESTRA**

LEVIER LONG DROITE  
 LONG RIGHT LEVER  
 LANGE RECHTE HEBEL  
 PALANCA LARGA DERECHA



Art./Ref.	Note/Notes	Brand
<b>04867</b>	Kit ricambio leva lunga dx/Replacement long right lever	<b>FIAT</b>

**PROLUNGA DE - SE PER DISTRIBUTORI LEVA LUNGA E CORTA**

BOUCHON DE - SE POUR DISTRIBUTEUR  
 DE - SE EXTENSION FOR LONG AND SHORT LEVER DISTRIBUTORS  
 DE - SE STÖPSEL  
 PROLONGADOR PARA DISTRIBUIDORES PALANCA LARGA E CORTA



Art./Ref.	Note/Notes	Brand
<b>04866</b>	Per distributori leva lunga e corta./For long and short lever distributors	<b>FIAT</b>

**RICAMBIO MOLLA PER DISTRIBUTORI LEVA LUNGA E CORTA**

RESSORT DE RECHANGE POUR DISTRIBUTEUR  
 REPLACEMENT SPRING FOR LONG AND SHORT LEVER DISTRIBUTORS  
 ERSATZFEDER STEUERGERAT KURZEN - LANGE HEBEL  
 RECAMBIO MUELLE



Art./Ref.	Note/Notes	Brand	Rif. Orig./Orig. Ref.
04865	Molla per distributori leva lunga e corta adattabile/for long and short lever distributors	FIAT	588779

**KIT COMPLETO PER L'APPLICAZIONE DEI DISTRIBUTORI ADATTABILE PER TRATTORI FIAT ""SERIE ORO"" LEVA SIN. E LEVA DX.**

KIT POUR L'APPLICATION DES DISTRIBUTEURS ADAPTABLE FIAT JUSQU'AU 640, LEVIERS DR. OU G.  
 HYDRAULIC COMPLETE SET FPR DISTRIBUTORS ADAPTABLE FIAT TRACTORS UP TO 640'S  
 KPL. HYDRAULIKSATZ MIT STEUERGERÄT PASSEND ZU FIAT SCHLEPPER BIS SERIE 640  
 KIT PARA APLICACIÓN DEL DISTRIBUIDOR ADAPTABLE TRACTORES ""FIAT""

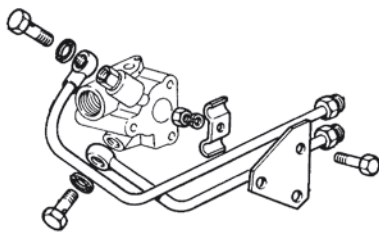

Art./Ref.	Note/Notes	Brand
04280	Adattabile a trattori FIAT "serie oro" leva sx e leva dx /Adaptable to FIAT'S ""oro"" line tractors, left and right lever	FIAT

**CORPO DISTRIBUTORE KONTAK 1° ELEMENTO**

DISTRIBUTEUR KONTAK 1ER ELEMENT  
 1ST ELEMENT FOR KONTAK DISTRIBUTOR  
 1 ELEMENT KONTAK STEUERGERÄT  
 DISTRIBUIDOR KONTAK 1° ELEMENTO

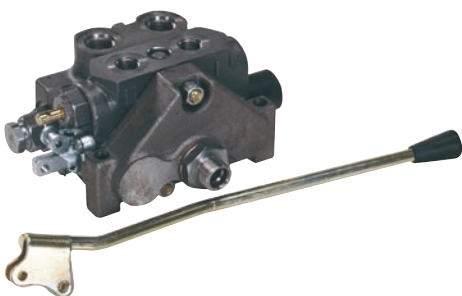

**Note:** Per presa a pressione supplementare del sollevatore adattabile a trattori FIAT.

**Notes:** Additional valve suitable for FIAT tractors.P

Art./Ref.	Note/Notes	Brand	Applicazione/Application
04285	Corpo distributore, 1° elemento/First element for distributor	FIAT	1000, 850

**SECONDO E TERZO ELEMENTO AGGIUNTIVO KONTAK ADATTABILE FIAT**

DEUXIEME ET TROISIEME ELEMENT KONTAK ADAPTABLE FIAT  
 SECOND AND THIRD KONTAK ELEMENTS SUITABLE FIAT  
 2 UND 3 ELEMENT KONTAK - STEUERGERÄT PASSEND ZU FIAT  
 DISTRIBUIDOR KONTAK 2° Y 3° ELEMENTO COMPATIBLE FIAT

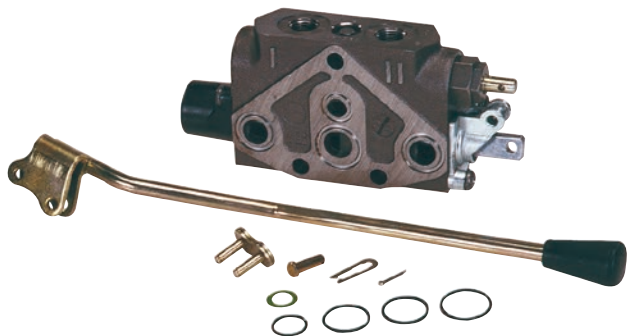

Art./Ref.	Note/Notes	Brand	Applicazione/Application	Rif. Orig./Orig. Ref.
<b>04290</b>	Doppio effetto/Double effect		55.65 F, 55.65 M, 55.65 V, 55.66, 55.66 DT, 55.66 DTL, 60.65, 60.65 M, 60.65 V, 60.66, 60.66 DT, 65.66, 65.66 DT, 70.65, 70.65 DT, 70.66, 80.65, 80.66, 80.66 DT, 85.55, 95.55	5116876, 5146658
<b>08652</b>	Doppio effetto flottante/ Flotating double effect	<b>FIAT</b>	100.55, 100.90-100.90DT, 110.90-110.90DT, 45.66-45.66DT, 45.66S-45.66S DT, 50.66-50.66DT, 50.66S-50.66S DT, 55.56-55.56DT, 55.65F-55.65M-55.65V-55.65 DT, 55.66S-55.66S DT, 55.66S-55.66S DT, 55.75F-55.75M-55.75V, 55.85F-55.85M-55.85V, 55.90-55.90DT, 60.56 DT, 60.65-60.65M, 60.66-60.66 DT-60.66S, 60.75-60.75M-60.75V, 60.76F DT, 60.85F-60.85V, 60.88-60.88 DT, 60.90-60.90 DT, 60.93, 60.94-60.94 DT, 62.85-62.85M, 62.86F-62.86F DT, 65.56-65.56 DT, 65.66-65.66 DT, 65.66S DT, 65.88-65.88 DT, 65.90-65.90 DT, 65.93-65.93 DT, 65.94-65.94 DT, 70.56-70.56 DT, 70.65M, 70.66-70.66V-70.66S, 70.75-70.75M, 70.76F DT, 70.88-70.88 DT, 70.90-70.90 DT, 72.85-72.85M, 72.86F DT, 72.93 DT, 72.94 DT, 80.65, 80.66-80.66 DT, 80.66S-80.66S DT, 80.75, 80.76F-80.76F DT, 80.88-80.88 DT, 80.90-80.90 DT, 82.86 DT, 82.93 DT, 82.94-82.94 DT, 85.55, 85.90 DT, 88.93-88.93 DT, 88.94-88.94 DT, 90.90-90.90 DT, 95.55, F100-F100 DT, F110-F110 DT, F115 DT, F120 DT, F130 DT, F140-F140 DT	5118355, 5136348, 5154669
<b>08652</b>	Doppio effetto flottante/ Flotating double effect	<b>FORD</b>	3435 2WD, 3935 2WD, 4030 2WD, 4135 2WD, 4230 2WD, 4430 2WD, 4635, 4835, 5635, 6635, 7635, 8160, 8260	-
<b>08652</b>	Doppio effetto flottante/ Flotating double effect	<b>NEW HOLLAND</b>	L60-L65-L75-L85-L95, M100-M115-M135, TK65F-TK75F, TK75M-TK75V, TK76-TK76M, TK85-TK85M, TK95M, TL70-TL80-TL90-TL100, TM115-TM120-TM125-TM130-TM140, TN55-TN55D-TN55S-TN55V, TN65-TN65D-TN65F-TN65N-TN65S, TN65V, TN70-TN70D-TN70F-TN70S, TN75-TN75D-TN75F-TN75N-TN75S, TN75V, TN80F, TN90F, TN95F	

**INNESTO RAPIDO ORIGINALE FASTER ADATTABILE GRUPPO SDF**

CONNEXION RAPIDE FEMELE D'ORIGINE FASTER PUSH-PULL ADAPTABLE

QUICK CONNECTION FASTER ORIGINAL SUITABLE SDF BRAND

KUPPLUNG WEIBLICH, UNTER DRUCK KUPPELBAR, ORIGINAL FASTER

CONEXIÓN RAPIDA ORIGINAL FASTER HEMBRA DE VAIVÉN

**Note:** Connessione spingendo la parte maschio.  
 Disconnessione tirando la parte maschio.  
 Innestabile con maschio (ISO A) in pressione.  
 Disconnessione in pressione solo come manovra di emergenza.  
 Intercambiabilita' secondo norme ISO 7241-1 parte A.

**Notes:** Connection by pushing the male coupling.  
 Disconnection by pulling the male part.  
 Connectable with male part (ISO A) under pressure.  
 Disconnection under pressure only as breakaway.  
 Interchangeability according to ISO 7241-1 part A

Art./Ref.	Descrizione/Description	Note/Notes	Brand	Applicazione/Application	Rif. Orig./Orig. Ref.	Immagine/Image
17091	Innesto rapido originale Faster femmina push-pull 1/2" - 1/2" BSP/Original ""Faster"" female 1/2"" - 1/2"" BSP push-pull quick coupling	Faster ref. 3CFPV 12 GAS F	LAMBORGHINI - DEUTZ - HURLIMANN - SAME	VARI MODELLI	-	
			FIAT	100.90-100.90 DT, 110.90-110.90 DT, 55.88-55.88 DT, 55.90-55.90 DT, 60.88-60.88 DT, 60.90-60.90 DT, 60.93-60.93 DT, 60.94-60.94 DT, 65.88, 65.90 DT, 65.93-65.93 DT, 65.94-65.94 DT, 70.76F DT, 70.76LP-70.76LP DT, 70.88-70.88 DT, 80.90-80.90 DT, F100 DT, F110-F110 DT, F115-F115 DT, F120-F120 DT, F130-F130 DT, F140-F140 DT	5152185, 5152194	
			FORD	5635-6635-4635-4835	-	
			NEW HOLLAND	L60-L65-L75-L85-L95, M100-M115-M135-M160, T5030-T5040-T5050-T5060-T5070, TK4020F-TK4020V, TK4030-TK4030F-TK4030V, TK4040-TK4040M, TK4050-TK4050M, TK4060	5152194	
75949	Innesto rapido originale Faster femmina push-pull M22x1,5/ Original ""Faster"" quick female push-pull coupling M22x1.5	Faster ref. 3CFPV 1/2215F	AGRITALIA	VARI MODELLI	-	
			NEW HOLLAND CASE	VARI MODELLI		
			CHALLENGER	MT425B-MT445B-MT455B, MT465B-MT475B, MT545B	3794298M2	
			JOHN DEERE	VARI MODELLI		
			LANDINI	VARI MODELLI		
			MASSEY FERGUSON	240-243-253-263-275-290, 2655-2855, 375-390, 410-420-430, 4215-4220, 4225-4235-4240, 4245-4255-4265, 4260-4270, 4265-4365, 4315-4320, 4325-4335, 4345-4355, 4360-4370, 6235-6245-6255, 6260-6265-6270-6280-6290, LT75A-LT85A-LT90A-LT95A, SERIE 5400, SERIE 6400, SERIE 7400	3794298M1, 3794298M2	
RENAULT	VARI MODELLI					
84442	Innesto rapido originale Faster femmina push-pull 1/2" - 1/2" NPT/Original "Faster" female push-pull 1/2" - 1/2" NPT quick coupling	Faster ref. 3CFPV 12 NPT F	NEW HOLLAND	VARI MODELLI		
84443	Innesto rapido originale Faster femmina push-pull 1/2" - 3/4" NPT/Original "Faster" female push-pull 1/2" - 3/4" NPT quick coupling	Faster ref. 3CFPV 34 UNF F	LANDINI	VARI MODELLI		

**FILTRO COMPLETO TIPO CAV CON SUPPORTO ADATTABILE**

COMPLETE FILTER TYPE CAV WITH SUPPORT

COMPLETE FILTER TYPE CAV WITH SUPPORT ADAPTABLE

CAV FILTER KPLT. MIT ANSCHLUSSPLATTE PASSEND ZU

FILTROS COMPLETOS TIPO "CAV" ADAPTABLE

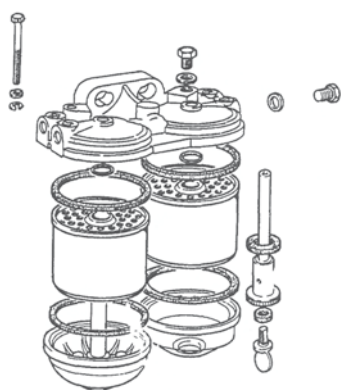

Pos.1



Pos.2

Art./Ref.	Pos.	Tipo/Type	Filettatura/Thread	Brand	Applicazione/Application	Rif. Orig./Orig. Ref.
<b>06271</b>	1	Singolo/Single	1/2" UNF.	<b>FENDT</b>	VARI MODELLI	
<b>11084</b>	2	Doppio/Double				
<b>06270</b>	1	Singolo/Single	Metrico M 14 x 1,5	<b>FIAT</b>	300-340-350, 500-550-640, 55.65 - 60.65, 55.66 - 60.66, 55.90 - 60.90	4612229, 4616707, 4776811, 9927913
<b>11085</b>	2	Doppio/Double	Metrico M 14 x 1,5			65.46, 65.66 - 70.66 - 80.66, 65.88 - 70.88 - 80.88, 70.65 - 80.65, 70.76 - 80.76, 1020-1120-2020-2120-3120, 1830-2030-2130
<b>06271</b>	1	Singolo/Single	1/2" UNF.	<b>FORD</b>	VARI MODELLI	
<b>11084</b>	2	Doppio/Double				83929882, EBPN9N166AA
<b>11084</b>	2	Doppio/Double	1/2" UNF.	<b>JOHN DEERE</b>	VARI MODELLI	
<b>11085</b>	2	Doppio/Double	Metrico M 14 x 1,5			1020-1120-2020-2120-3120, 1830-2030-2130
<b>06271</b>	1	Singolo/Single	1/2" UNF.	<b>LANDINI</b>	VARI MODELLI	883786M91
<b>11084</b>	2	Doppio/Double				1446891M91, 894976M91
<b>06271</b>	1	Singolo/Single	1/2" UNF.	<b>MASSEY FERGUSON</b>	VARI MODELLI	883786M91
<b>11084</b>	2	Doppio/Double				1446891M91, 894976M91
<b>06271</b>	1	Singolo/Single	1/2" UNF.	<b>PERKINS</b>	VARI MODELLI	2656615
<b>11084</b>	2	Doppio/Double				2656804, 2656811

**RICAMBI PER FILTRI COMPLETI ADATTABILI**

RECHANGES POUR FILTRE TYPE ADAPTABLE

PARTS FOR COMPLETE FILTERS ADAPTABLE

ERSATZTEILE FILTER PASSEND ZU

RECAMBIOS PARA FILTROS COMPLETOS ADAPTABLE

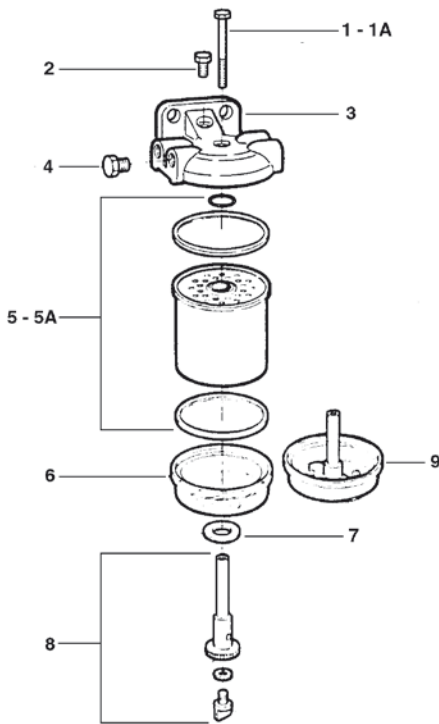

Art./Ref.	Pos.	Note/Notes	Brand	Applicazione/Application	Rif. Orig./Orig. Ref.
02731	5	Tipo CAV 296 basso - rif. orig. CAV 7111-296/Type CAV 296 short - orig. ref. CAV 7111-296	FENDT	108LSA, 108S, 200S, 201S, 203V, 204P, 205P, 240S, 250SA, 250VA, 275VA, 280PA	F278201060040
06272	3	Supporto per una vasca passo decimale - rif. orig. CAV 7111-353BV/Support for decimal plug - orig. ref. CAV 7111-353BV		-	9918117, 9927918
06273	3	Supporto per una vasca passo pollice - rif. orig. CAV 7111-353AS/Support for inch pluch - orig. ref. CAV 7111-353AS		-	9927916
02731		Tipo CAV 296 basso - rif. orig. CAV 7111-296/Type CAV 296 short - orig. ref. CAV 7111-296	FIAT	3300 MIETITREBBIA LAVERDA, 3300AL MIETITREBBIA LAVERDA, 3300R MIETITREBBIA LAVERDA, 3400 MIETITREBBIA LAVERDA, 3400R MIETITREBBIA LAVERDA, 3500 MIETITREBBIA LAVERDA, 3500AL MIETITREBBIA LAVERDA, 3500R MIETITREBBIA LAVERDA, 3550 MIETITREBBIA LAVERDA, 3550R MIETITREBBIA LAVERDA, 355C, 3650 MIETITREBBIA LAVERDA, 3650R MIETITREBBIA LAVERDA, 3750 MIETITREBBIA LAVERDA, 3750R MIETITREBBIA LAVERDA, 455C, 465C, 465C/V/F, 505C, 555c, 565c, 605c, 765c, 805c, 80C, 855c, 90C, L517 MIETITREBBIA LAVERDA, SERIE 55 85.55.00, SERIE 65 80.65C, SERIE 65 60.65C, SERIE 65 70.65C, SERIE 66 65.66, SERIE 66 80.66, SERIE 66 80.66/F, SERIE 66 55.66, SERIE 66 60.66, SERIE 66 70.66, SERIE 66 70.66/LP-F, SERIE 66 55.66/LP, SERIE 75 70.75C, SERIE 75 80.75C, SERIE 76 70.76/LP-VF, SERIE 76 80.76/F, SERIE 85 88.85C, SERIE 85 72.85C, SERIE 85 82.85C, SERIE 88 70.88, SERIE 88 80.88, SERIE 90 115.90, SERIE 90 70.90, SERIE 90 85.90, SERIE 90 140.90, SERIE 90 55.90, SERIE 90 60.90, SERIE 90 65.90, SERIE 90 130.90, SERIE 90 80.90, SERIE 93 72.93, SERIE 93 88.93, SERIE 93 65.93, SERIE 93 82.93, SERIE 94 82.94, SERIE 94 88.94, SERIE 94 65.94, SERIE 94 72.94	1901687, 1909100, 4621740, 4651986, 4669551, 4669556, 4680444, 4787696, 70251397, 84535312, 9918114, 9924318
02742		Tipo Cav Lungo - rif. orig. CAV 7111-796/Gasoil adapt. CAV long CAV 7111-796/		555C - 655C TERNA GOMMATA, 555D - 575D - 655D TERNA GOMMA	1930277
02721		Vasca Decantatore Vetro - rif. orig. CAV 7111-429/Glass Fuel Filter Bowl - orig. ref. CAV 7111-429			9918123
06275	6	Vasca decantatore in alluminio - rif. orig. CAV 7111-493/ Aluminum fuel filter bowl - orig. ref. CAV 7111-493			9918123
08471	7	Gommino grande perno centrale/Large rubber center pin			9918124

Art./Ref.	Pos.	Note/Notes	Brand	Applicazione/Application	Rif. Orig./Orig. Ref.
<b>06273</b>	3	Supporto per una vasca passo pollice - rif. orig. CAV 7111-353AS/Support for inch pluch - orig. ref. CAV 7111-353AS	<b>FORD</b>		83919133
<b>02731</b>		Tipo CAV 296 basso - rif. orig. CAV 7111-296/Type CAV 296 short - orig. ref. CAV 7111-296		2000 BSD 326, 2310 BSD 326, 2600 BSD 326, 2610>01.81 BSD 329, 2610>01.82 BSD 329, 2810 BSD 326, 2910 BSD 329, 3000 BSD 329, 3055 BSD 331, 3230 BSD 332, 3430 BSD 332, 3435 8035.06, 3600 BSD 329, 3610>01.81 BSD 332, 3610>01.82 BSD 332, 3900 BSD 332, 3910 BSD 332, 3910 H BSD 332, 3930 BSD 333, 3930 H BSD 332, 3935 8035.06, 4000 BSD 333, 4100 BSD 331, 4110>01.81 BSD 333H, 4110>01.82 BSD 333H, 4130 BSD 333, 4130 H BSD 333, 4135 8035.06, 4330 BSD 333, 4600 BSD 333H, 4610 H BSD 333, 4610>01.81 BSD 333H, 4610>01.82 BSD 333H, 4630 BSD 333H, 4635 L60 8035.05, 4830 BSD 442, 4835 L65 8045.06, 5000 4/68< BSD 442, 5000 <3/68 BSD 348, 5030 BSD 442, 5110 BSD 444, 550 BSD 333H, 555 BSD 333H, 555 A BSD 333, 555 B BSD 333, 555 C BSD 444, 5600 10/80< BSD 444, 5600<09/80 BSD 442, 5610 BSD 444, 5635 L75 8045.06, 5640 P.S. 4.4, 5700 10/80< BSD 444, 5700<09/80 BSD 442, 5900 BSD 444, 6410 BSD 444, 655 BSD 444, 655 A BSD 444, 655 C BSD 444, 655 D BSD 444, 6600 10.80> BSD 444, 6600>09.80 BSD 444, 6610 BSD 444, 6635 L85 8045.25, 6640 P.S. 5.0, 6700 BSD 444, 6710>09.80 BSD 444, 6710>10.80 BSD 444, 6810 BSD 444TS, 7000 BSD 444T, 7410 BSD 444T, 7600 BSD 444TS, 7610 BSD 444TS, 7635 L95 8045.25, 7700 BSD 444TS, 7710 BSD 444TS, 7740 P.S. 5.0T, 7810 BSD 666, 7840 P.S. 6.6, 7910 BSD 666, 8000 BSD 666, 8100 BSD 380, 8160 M100 P.S. 7.5, 8200 BSD 666, 8210 BSD 666, 8240 P.S. 7.5, 8260 M115 P.S. 7.5, 8340 9/93< P.S. 7.5T, 8340<8/93 P.S. 7.5, 8360 M135 P.S. 7.5T, 8401 BSD 666, 8530 BSD 666, 8560 M160 P.S. 7.5TI, 8600 BSD 666, 8630 BSD 666T, 8670 G170 P.S. 7.5T, 8700 BSD 666, 8730 BSD 666T, 8770 G190 P.S. 7.5T, 8830 BSD 666TI, 8870 G210 P.S. 7.5TI, 8970 G240 P.S. 7.5TI, 9000 BSD 666T, 9200 BSD 666T, 9600 BSD 666T, 9700 BSD 666T, TW 10, TW 15, TW 20, TW 25, TW 30, TW 35, TW 5	83937061, 84535312
<b>02742</b>		Tipo Cav Lungo - rif. orig. CAV 7111-796/Gasoil adapt. CAV long/Naptha, Cav long - orig. ref. CAV 7111-796		3230 - 3430, 3930, 3930H - 3930N - 3930NO, 4130 - 4130N - 4130NO, 4630 - 46300 - 4630N - 4630NO, 4830 - 4830N - 48300, 5030 - 50300, 5110 - 5610, 6410 - 6610 - 6710 - 6810, 66100 - 76100, 7410 - 7610 - 7710, TW10 - TW20 - TW30	1930277, 83917626, 86570171
<b>06277</b>	9	Vasca decantatore in alluminio con perno - rif. orig. CAV 7111-542A/Aluminum fuel filter bowl with pin - orig. ref. CAV 7111-542A			
<b>02731</b>	5	Tipo CAV 296 basso - rif. orig. CAV 7111-296/Type CAV 296 short - orig. ref. CAV 7111-296	<b>JOHN DEERE</b>	1020, 1030, 1120, 1130, 1630, 2020, 2030, 3020, 3130, 4020, 820, 830, 920, 930	AT17387
<b>02731</b>	5	Tipo CAV 296 basso - rif. orig. CAV 7111-296/Type CAV 296 short - orig. ref. CAV 7111-296	<b>KUBOTA</b>		15451-43560



Art./Ref.	Pos.	Note/Notes	Brand	Applicazione/Application	Rif. Orig./Orig. Ref.
02731		Tipo CAV 296 basso - rif. orig. CAV 7111-296/Type CAV 296 short - orig. ref. CAV 7111-296	LANDINI	ADVANTAGE CABINATO: 55F, ADVANTAGE CABINATO: 55GT, ADVANTAGE CABINATO: 55L, ADVANTAGE CABINATO: 60F, ADVANTAGE CABINATO: 60GT, ADVANTAGE CABINATO: 60L, ADVANTAGE CABINATO: 65F, ADVANTAGE CABINATO: 65GT, ADVANTAGE CABINATO: 65L, ADVANTAGE CABINATO: 75F, ADVANTAGE CABINATO: 75GT, ADVANTAGE CABINATO: 75L, ADVANTAGE CABINATO: 85F, ADVANTAGE CABINATO: 85GT, ADVANTAGE CABINATO: 85L, ADVANTAGE CABINATO: L95GT, ADVANTAGE F.S: 55FP/LP/GT, ADVANTAGE F.S: 60FP/LP/GT, ADVANTAGE F.S: 65FP/LP/GT, ADVANTAGE F.S: 75FP/LP/GT, ADVANTAGE F.S: 85FP/LP/GT, ATLAS: 100, ATLAS: 70, ATLAS: 75, ATLAS: 80, ATLAS: 85, ATLAS: 90, BLIZZARD: 50, BLIZZARD: 60, BLIZZARD: 65, BLIZZARD: 75, BLIZZARD: 85, BLIZZARD: 95, CINGOLATI C:C4500, CINGOLATI C:C4830, CINGOLATI C:C5500, CINGOLATI C:C5830, CINGOLATI C:C6500, CINGOLATI C:C6830, CINGOLATI C:C7800, CINGOLATI C:C7830, CINGOLATI C:C8860, CINGOLATI: C5000, CINGOLATI: C6000, CINGOLATI: CF4830, CINGOLATI: CF5030, CINGOLATI: CF5830, CINGOLATI: CF6030, CINGOLATI: CF6060, CINGOLATI: CF6830, FRUTTETI 530 F/L/V: 4530V, FRUTTETI 530 F/L/V: 5530 F/L/V, FRUTTETI 530 F/L/V: 6030 F/L/V, FRUTTETI 530 F/L/V: 6530 F/L/V, FRUTTETI 530 F/L/V: 7530 F/L, FRUTTETI 560 F/L/V: 4560V, FRUTTETI 560 F/L/V: 5560 F/L/V, FRUTTETI 560 F/L/V: 6060 F/L/V, FRUTTETI 560 F/L/V: 6560 F/L/V, FRUTTETI 560 F/L/V: 7560 F/L, FRUTTETI 560 F/L/V: 8560 F/L, GHIBLI: 100, GHIBLI: 90, GHIBLI:80, GLOBUS: 55, GLOBUS: 60, GLOBUS: 65, GLOBUS: 70, LARGE: 10000, LARGE: 10000S, LARGE: 12500, LARGE: 13000, LARGE: 14500, LEGEND N/G: 115, LEGEND N/G: 120, LEGEND N/G: 130, LEGEND N/G: 140, LEGEND N/G: 160, LEGEND N/G: 180, LEGEND: 105, LEGEND: 115, LEGEND: 130, LEGEND: 145, LEGEND: 165, MYTHOS: 110, PRIMI MODELLI 5000R-DT-S-N, PRIMI MODELLI 6000R-DT-S, PRIMI MODELLI 7000 SPECIAL, PRIMI MODELLI 7000R-DT, PRIMI MODELLI 8000R-DT-S, REX CABINATI: 100, REX CABINATI: 60, REX CABINATI: 70, REX CABINATI: 80, REX CABINATI: 90, REX FOOT STEP: 100FP-LP-GTP-GE, REX FOOT STEP: 60FP-LP-GE, REX FOOT STEP: 70FP-LP-GTP-GE, REX FOOT STEP: 80FP-LP-GTP-GE, REX FOOT STEP: 90FP-LP-GTP-GE, SERIE 30: 5830, SERIE 30: 6030, SERIE 30: 6830, SERIE 30: 7830, SERIE 30: 8830, SERIE 40: 5840, SERIE 40: 6040, SERIE 40: 6840, SERIE 500: 5500, SERIE 500: 6500, SERIE 500: 7500, SERIE 500: 8500, SERIE 500: 9500R-DT, SERIE 50: 6550, SERIE 50: 7550, SERIE 50: 8550, SERIE 60 NEW: 5860, SERIE 60 NEW: 6860, SERIE 60 NEW: 7860, SERIE 60 NEW: 8860, SERIE 60: 5860, SERIE 60: 6060, SERIE 60: 6860, SERIE 60: 7860-7860HC, SERIE 60: 8860-8860HC, SERIE 60: 9060, SERIE 70: 5870, SERIE 70: 6070, SERIE 70: 6870, SERIE 70: 7870, SERIE 70: 8870, SERIE 80: 6880, SERIE 80: 7880, SERIE 80: 8880-8880HC, SERIE 80: 9080-9080HC, SERIE 80: 9880-9880HC, TREKKER NEW 100C, TREKKER NEW 70 C/F/L, TREKKER NEW 80 C/F/L, TREKKER NEW 90 C/F/L, TREKKER: C75, TREKKER: C85, TREKKER: C95, TREKKER: CF55, TREKKER: CF60, TREKKER: CF65, TREKKER: CF70, TREKKER: CF75, TREKKER: CF85, VIGNETI CABINA V.Q: 55V, VIGNETI CABINA V.Q: 60V, VIGNETI CABINA V.Q: 65V, VIGNETI CABINA V.Q: 75V, VIGNETI F.S: 55V, VIGNETI F.S: 60V, VIGNETI F.S: 65V, VIGNETI FOOT STEP: 75V, VIGNETI REX CAB: 60V, VIGNETI REX CAB: 65V, VIGNETI REX CAB: 70V, VIGNETI REX CAB: 80V, VISION: 100, VISION: 80, VISION: 90	E3541160M1
02742		Tipo Cav Lungo - rif. orig. CAV 7111-796/Gasoil adapt. CAV long/Naphtha, Cav long - orig. ref. CAV 7111-796		CINGOLATI: C10500, LARGE: 16000, LARGE: 16500	1896287M91, E3541382M1
02731	5	Tipo CAV 296 basso - rif. orig. CAV 7111-296/Type CAV 296 short - orig. ref. CAV 7111-296	LOMBARDINI	673, 825, LDA 670, SLD675	2175.042

Art./Ref.	Pos.	Note/Notes	Brand	Applicazione/Application	Rif. Orig./Orig. Ref.
<b>02731</b>	5	Tipo CAV 296 basso - rif. orig. CAV 7111-296/Type CAV 296 short - orig. ref. CAV 7111-296	<b>MASSEY FERGUSON</b>	1080 A4.318, 1100 A6.354.1, 1105 A6.354.4, 1135 A6.354.4, 1200 A6.354.1, 1250 A6.354.4, 135 AD3.152, 148 AD3.152, 155 AD4.203, 158 AD4.203, 165 A4.212, 165 AD4.203, 168 A4.236, 175 A4.236, 178 A4.248, 185 A4.248, 230 AD3.152, 235 AD3.152, 240 AD3.152, 250 AD3.152, 255 AD3.152, 260 AD4.203, 2620 A6.354.4, 2625 A6.354.4, 2640 A6.354.4, 2645 A6.354.4, 265 A4.236, 2680 AT6.354.4, 2685 AT6.354.4, 2720 AT6.354.4, 2725 AT6.354.4, 275 A4.236, 285 A4.248, 285 A4.318, 290 A4.248, 294 A4.248, 296, 298 A4.318, 3050 A4.236, 3060 A4.248, 3065 A4.236, 3070 A4.236, 3075 1004.4, 3075 A4.236, 3080 A6.354.4, 3085 1006.6, 3090 A6.354.4, 3095 1006.6, 3115 1006.6, 3120 1006.6T, 3120T 1006.6T, 3125 1006.6T, 3140 1006.6T, 340 AD3.152, 342 AD3.152, 35 A3.152, 350 AD3.152, 352 AT3.152, 355 AT3.152, 360 AT3.152, 3610 A6.354.4, 362 A4.236, 3630 AT6.534.4, 3635 1006.6T, 3645 1006.6T, 3645 AT6.354.4, 365 A4.236, 3650 AT6.354.4, 3655 1006.6T, 3660 1006.6T, 372 A4.236, 375 A4.236, 382 A4.248, 390 A4.248, 390T A4.236, 398 A4.236, 399 1006.6, 399 A6.354.4, 4225 1004.4, 4225 4.41, 4235 1004.4, 4235 4.41, 4245 1004.4T, 4255 1004.4T, 4255 4.41, 4260 1006.6, 4270 1006.6, 550 AD3.152, 560 AD4.203, 565 A4.236, 575 A4.236, 590 A4.248, 595 A4.318, 6110 4.41, 6120 4.41, 6130 1004.4T, 6140 1004.4T, 6150 1004.4T, 6160 1006.6, 6160 1006.6T, 6170 1006.6, 6170 1006.6T, 6180 1006.6T, 6190 1006.6T, 65 A4.203, 65 AD4.203, 675 A4.236, 690 A4.248, 698 A4.318, 698T A4.236, 699 A6.354.4, 765 AD4.203, 8110 1006.6T, 8120 1006.6T <F, 8120 1006.6T FO, 8130 1006.6T	1049939M91, 151890M1, 1640997M91, 1802271M1, 1841890M1, 1951890M1, 2871492M1, 3405418M1, 835994M92, 836218M91, 851890M1
<b>02742</b>	5	Tipo Cav Lungo - rif. orig. CAV 7111-796/Gasoil adapt. CAV long/Naphtha, Cav long - orig. ref. CAV 7111-796		1080 A4.318, 1100 A6.354.1, 1105 A6.354.4, 1135 A6.354.4, 1200 A6.354.1, 1250 A6.354.4, 135 AD3.152, 148 AD3.152, 155 AD4.203, 158 AD4.203, 165 A4.212, 165 AD4.203, 168 A4.236, 175 A4.236, 178 A4.248, 185 A4.248, 230 AD3.152, 235 AD3.152, 240 AD3.152, 250 AD3.152, 255 AD3.152, 260 AD4.203, 2620 A6.354.4, 2625 A6.354.4, 2640 A6.354.4, 2645 A6.354.4, 265 A4.236, 2680 AT6.354.4, 2685 AT6.354.4, 2720 AT6.354.4, 2725 AT6.354.4, 275 A4.236, 285 A4.248, 285 A4.318, 290 A4.248, 294 A4.248, 298 A4.318, 3050 A4.236, 3060 A4.248, 3065 A4.236, 3070 A4.236, 3080 A6.354.4, 3090 A6.354.4, 340 AD3.152, 342 AD3.152, 350 AD3.152, 352 AT3.152, 355 AT3.152, 360 AT3.152, 3610 A6.354.4, 362 A4.236, 3630 AT6.534.4, 3645 AT6.354.4, 365 A4.236, 3650 AT6.354.4, 372 A4.236, 375 A4.236, 382 A4.248, 390 A4.248, 390T A4.236, 398 A4.236, 550 AD3.152, 560 AD4.203, 565 A4.236, 575 A4.236, 590 A4.248, 595 A4.318, 675 A4.236, 690 A4.248, 698 A4.318, 698T A4.236, 699 A6.354.4, 765 AD4.203, 796, 8120 1006.6T FO	1896287M1, 3405419M1
<b>02721</b>	6	Vasca Decantatore Vetro - rif. orig. CAV 7111-429/Glass Fuel Filter Bowl - orig. ref. CAV 7111-429		-	1039071M1
<b>02731</b>	5	Tipo CAV 296 basso - rif. orig. CAV 7111-296/Type CAV 296 short - orig. ref. CAV 7111-296	<b>NEW HOLLAND</b>	L454 MINI PALE, L455 MINI PALE, L553 MINI PALE, L555 MINI PALE, L778 MINI PALE, L779 MINI PALE, L781 MINI PALE, L783 MINI PALE, L785 MINI PALE, L865 MINI PALE, LX865, LX885, SB33 BRAUD VENDEMMIATRICI, SB52 BRAUD VENDEMMIATRICI, SB53 BRAUD VENDEMMIATRICI, SB54 BRAUD VENDEMMIATRICI, SB56 BRAUD VENDEMMIATRICI, SB58 BRAUD VENDEMMIATRICI, TS 100, TS 110, TS 115, TS 80, TS 90	1909100, 84535312
<b>02731</b>	5	Tipo CAV 296 basso - rif. orig. CAV 7111-296/Type CAV 296 short - orig. ref. CAV 7111-296	<b>PERKINS</b>	1004.40, 1004.40T, 1004.42, 3.152.2, 3.152.4, 4.108, 4.236, 403D-11, 403D-15, 404D-22, 6.354.4, D3.152, T4.236, T6.354.4	26560017, 26561117
<b>02742</b>	5	Tipo Cav Lungo - rif. orig. CAV 7111-796/Gasoil adapt. CAV long/Naphtha, Cav long - orig. ref. CAV 7111-796		6.354 - T6.354, 6.354.4 - T6.354.4, V8.540 - TV8.540	26560602, 26566602
<b>02721</b>	6	Vasca Decantatore Vetro - rif. orig. CAV 7111-429/Glass Fuel Filter Bowl - orig. ref. CAV 7111-429		-	26560111, 26560601
<b>06275</b>	6	Vasca decantatore in alluminio - rif. orig. CAV 7111-493/ Aluminum fuel filter bowl - orig. ref. CAV 7111-493		-	26560111

Art./Ref.	Pos.	Note/Notes	Brand	Applicazione/Application	Rif. Orig./Orig. Ref.
02731	5	Tipo CAV 296 basso - rif. orig. CAV 7111-296/Type CAV 296 short - orig. ref. CAV 7111-296	RENAULT	103.12RS/TX, 103.14RS/TX, 103.54TM/TX, 106-14SP, 110-14RE/TA/TE/TX, 106.14RS/TX, 106.54TL, 110.54T, 106.54 MWM, 110-54TA/TE/TX/TZ, 120-54TA, 113.14TX, 133.14TS/TX, 145.14T, 1151 1151-4, 1181 1181-4, 1451-4 (R7694), 155.54TZ, 155.54TX/TZ/Nectra,, 301, 351M, 32-5032-60, 321-4, 451-4, 571-4, 42-70F/V, 44-70F/V, 421 M, 421M, 456 M, 460 M, 461, 461M/Spezial, 462 M, 466S, 480S/V, 486 M, 489 M, 490 (R7398-4-L), 496 M, 498 M, 50 (7211) MWN 325-2, 50 S/SV MWN D327-2, 50.12LB, 55.12LB, 58.32MX, 58., 501-4, 601-4, 51 (7256) 56 (7251), 53 (7213) MWN 325-2, 55 (7231) 57 (7241), 551 551-4, 551-43, 556 556S, 58-12LS, 58-14LS, 61-12RA/RS,, 58-32MA/ME/MS/MX, 58-34MA/ME/M, 60 (7253) 61 (7254), 600M, 600MI, 60S MWN 325-3, 61.12RS, 61.14S/RS MWN 325-3, 65.12LS, 65.32MX, 65.34MX D22, 651, 651-4, 652, 656, 656S, 68, 68-12RA/RS, 68-14RA/RS, 75-12L, 68.12RS 68.14RS, 70 MWM D305-3R, 70 (7252) MWM, 70-12SP, 70-14SP, 70-32PA/PE/PS/PX, 70-34PA/PE/P, 70.12LB, 70.14LB, 70.34PX/Trac, 700M/H, 720M/H, 704M/H, 724M/H, 701-4, 701-4F, 75-32MA/ME/MS/MX/TX, 75-34ME/M, 750MI, 745MI, 800M, 804M, 850M, 751, 751S, 751-4, 752, 781, 78, 80 MWM D305-3R, 80 MWM D325-3R, 80 (7282) 86 (7281), 80-12, 80-14, 85.34MX, 85.34TX, 80-12SP, 80-14SP, 80-12TX, 80-14TX, 80-32PA/PE/PS/PX, 80-34PA/PE/P, 80S/V MWM D327, 85-12LS/TS/TX, 85-14LS/TS/TX, 85-32MA/ME/MS/MX/TX, 85-34MA/M, 85.12LS 85.14LS, 851, 851-4, 851-4S, 86, 88 598-, 89 MWM D226-3, 891, 891-4, 90.34MX/Tracfor, 90.34TX91TP91, 900MIH, 904MIH, 90S/V/Conf, 92, 921 921-4, 95-12RE/RS/TS/TX, 95-14RE/RS/T, 95.12TX 95.14TX, 981 981-4, Ceres65, Ceres70, Ceres70X, Ce, Ceres85, Ceres85X, Ceres95, Ce, Master 1, Master 1 TP, Master, MWM D325-4R, 226-4, 325-4, D22, R301, R351M, R32-50EV-SV-V, R32-60F-V(A/B),, R361, R421-421M, R461, R461M,, R42-70V, R44-70F, R90S Verger,, R50, R51, R56, R60, R70, R80,, R50S, R53, R55, R551, R551S, R551-4, R551-4S,, R651, R651S, R651-4, R651-4S,, R751, R751S, R751-4, R751-4S,, R782, R782-4, R851, R851-4, R8, R89, R92, R489, R891, R891S, R891-4S, R951, R9, R91, R94, R96, R98, R496, R498, Super 5D, Super 7, Super 7D	6005000894, 6005007409
02742	5	Tipo Cav Lungo - rif. orig. CAV 7111-796/Gasoil adapt. CAV long/Naphtha, Cav long - orig. ref. CAV 7111-796		110-54TA/TE/TS/TX/TZ, 120-54TA, 133-12TS/TX, 133-14RE/TA/TS/TX, 58-12LS, 58-14LS, 61-12RA/RS,, 58-32MA/ME/MS/MX, 58-34MA/ME/M, 650MI	6005000895, 6005007410
02731	5	Tipo CAV 296 basso - rif. orig. CAV 7111-296/Type CAV 296 short - orig. ref. CAV 7111-296	RUGGERINI	833	
02731		Tipo CAV 296 basso - rif. orig. CAV 7111-296/Type CAV 296 short - orig. ref. CAV 7111-296	SAME	ANTARES 100, ASTER 60, ASTER 70, AURORA 45, BUFFALO 120, CENTAURO 70 EXPLORER, CENTAURO 70 SPECIAL, CENTURION 75, CENTURION 75 EXPLORER, CENTURION 75 SPECIAL, CONDOR 55, CONDOR C, CORSARO 70 FRUTTETO, CORSARO 70 SYNCRO, DELFINO 35, DELFINO 35 FRUTTETO, DRAGO 100, EXPLORER 70 C, EXPLORER 55, EXPLORER 60, EXPLORER 60 SPECIAL, EXPLORER 65, EXPLORER 65 C, EXPLORER 65 SPECIAL, EXPLORER 70, EXPLORER 70 SPECIAL, EXPLORER 75, EXPLORER 75 C, EXPLORER 75 SPECIAL, EXPLORER 80, EXPLORER 80 C, EXPLORER 90 C, EXPLORER 90 II SPECIAL, EXPLORER 90 SPECIAL, EXPLORER II 60, EXPLORER II 60 SPECIAL, EXPLORER II 70, EXPLORER II 70 SPECIAL, EXPLORER II 70 SPECIAL B, FRUTTETO 60, FRUTTETO 60 II, FRUTTETO 75, FRUTTETO 75 II, FRUTTETO 85 II, LEOPARD 85, LEOPARD 85 EXPLORER, LEOPARD C, MERCURY 85 EXPLORER, MERCURY 85 SPECIAL, MINITAURO 60, MINITAURO 60 FRUTTETO, MINITAURO C, MINITAURUS 60 FRUTTETO, MINITAURUS 60 SYNCRO, PANTHER 95, RANGER 45, RANGER 45 FRUTTETO, ROW CROP 80, ROW CROP 85, ROW CROP 90, SAME ROCK 55, SAME ROCK 60, SAME ROCK 70, SATURNO 80, SATURNO 80 SYNCRO, SOLAR 50, SOLAR 55 C, SOLAR 60, SOLAR 60 C	2.4319.060.1
02742		Tipo Cav Lungo - rif. orig. CAV 7111-796/Gasoil adapt. CAV long/Naphtha, Cav long - orig. ref. CAV 7111-796		ANTARES 110 - 110 II, ANTARES 130 - 130 II, BUFFALO 3000, DRAGO 100 - 120, GALAXI 170, JAGUAR 95 - 100 EXPORT, LASER 100, LASER 110, LASER 125, LASER 130, LASER 150, LASER 90, LEOPARD 90 TURBO, PANTHER 90 - 95, SUPERTITAN, TIGER 100, TIGER SIX 105 EXPORT, TITAN 145, TITAN 150, TITAN 160, TITAN 165, TITAN 190, TRIDENT 130 EXPORT	2.4319.130.1
02742		Tipo Cav Lungo - rif. orig. CAV 7111-796/Gasoil adapt. CAV long/Naphtha, Cav long - orig. ref. CAV 7111-796	STEYR	M9078A, Valmet 420.81, 420., M9086 Valmet 420.81, 420.82,, M9094 Valmet 420.81, 420.	P945X

**RICAMBI PER FILTRI COMPLETI ADATTABILI VARI BRAND**

RECHANGES POUR FILTRE TYPE ADAPTABLE MARQUES DIVERS  
 PARTS FOR COMPLETE FILTERS ADAPTABLE VARIOUS BRANDS  
 ERSATZTEILE FILTER PASSEND ZU VIELZAHL VON MARKEN  
 RECAMBIOS PARA FILTROS COMPLETOS ADAPTABLE DIFERENTES MARCAS

Art./Ref.	Pos.	Note/Notes
06281	1	Prigioniero coperchio filtro tipo "ALTO"/Filter head bolt "HIGH" type
06279	4	Tappo chiusura lat. coperchio passo decimale/Lat. closing decimal filter head bl/ing plug
06280	4	Tappo chiusura lat. coperchio passo pollice/Lat. Closing inch filter head bl/ing plug
40506	10	Raccordo 1/2 Unf - Fitting 1/2 Unf
40507	11	Raccordo 90°/Fitting 90°

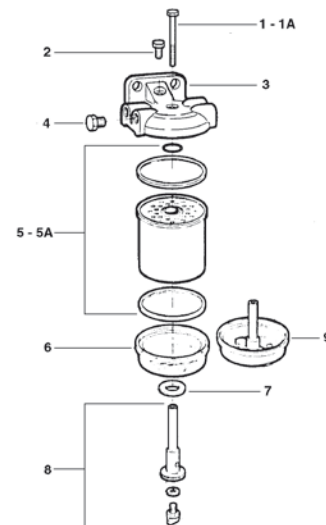
**VASCHETTA ALIMENTAZIONE CARBURANTE GRUPPO FILTRANTE ADATTABILE**

RESERVOIR ALIMENTATION GASOIL GROUPE FILTRANT ADAPTABLE  
 FUEL INJECTION TANK FOR FILTERING GROUP ADAPTABLE  
 KRAFTSTOF SPEISUNGS BECHER FUER FILTER TYP CAV PASSEND ZU  
 SUMIDERO ALIMENTACION CARBURANTE PARA FILTRO ADAPTABLE

Art./Ref.	Brand	Applicazione/Application	Rif. Orig./Orig. Ref.
03064	FIAT	1000, 1100, 1300, 1355, 1380, 1580, 160.90-160.90 DT, 650, 655, 700, 750, 800, 850, 900	705599, 75204389, 766875, 772163, 79047888
	FORD	8630	772163
	LAVERDA	3300AL-3400-3400R, 3500-3500R-3550-3550R, 3550AL - MX240 - MX240R, 3650-3650R-3750-3750R	766875, 772163
	NEW HOLLAND	TK160-55	772163

**POMPE NAFTA A MEMBRANA ORIGINALI BCD**

POMPES GASOIL A MEMBRANE ORIGINAL BCD  
 DIAPHRAGM FUEL PUMP ORIGINAL BCD  
 DIESELKRAFTSTOFFPUMPE ORIGINAL BCD  
 BOMBA NAFTA DE MEMBRANA ORIGINAL BCD

Art./Ref.	Tipo BCD/Type BCD	Note/Notes
BCD1949/5	1949/5	rif. AMA - 03612 / 03612TOP
BCD1930/5	1930/5	rif. AMA - 02110 / 02110TOP
BCD2518/5	2518/5	
BCD1947/6	1947/6	rif. AMA - 00754 / 00754TOP
BCD1948/6	1948/6	
BCD1969/5	1969/5	
BCD2625/1	2625/1	rif. AMA - 03674 / 03674TOP



**POMPE NAFTA A MEMBRANA ADATTABILI**

POMPES GASOIL A MEMBRANE ADAPTABLE  
 DIAPHRAGM FUEL PUMP ADAPTABLE  
 DIESELKRAFTSTOFFPUMPE PASSEND ZU  
 BOMBA NAFTA DE MEMBRANA ADAPTABLE



Art./Ref.	Tipo BCD/Type BCD	Brand	Applicazione/Application	Rif. Orig./Orig. Ref.
03612	1949/5	BRAUD	1214, SB52, SB54, SB56, SB58, SB60, SB62, SB64	4757884
02106	2567	CARRARO	600 MOT. PERKINS 4.236, 700 MOT. PERKINS 4.236, 800 MOT. PERKINS 4.248	910602, AK-063/0
03613	2558		315, 340, 425, 430, 452 DT, 454 455 C, 504, 515, 575, 604 MOT. 315, 655 CL MOT. 425, 704 MOT. 505, 954 MOT. 575, CARRO 4500 CS MOT. 285, MOT. 285, MOT. 450 DT, TR. 502, TR. 602, TR. 650 DT, TR. 702, TR. 952, VICTORY 7100 N & 4RM MOT. 425, VICTORY 7500 N & 4RM MOT. 505, VICTORY 8800N MOT 575, VICTORY 9800DF	30332, 30333
40431	2697	CASE	CX100, CX70, CX80, CX90	295976A1, 427309A1
92936	2695		INDUSTRIAL	87800194
92937	2723		100 TL, 105A, P70(TIER2,TIER3), 580M, 580SM, 590SM (serie 2), JX1080U, JX1090U, JX1100U,, JX1085C, JX1095C	2830266, 84268475
03680	1662/7	DEUTZ	13006, 15, 2505, 2506, 2807, 30, 3005, 3006, 3006F, 3607, 3607F, 40, 40/2, 4005, 4006, 4006F/S, 4006U, 4007, 4007F, 4007U, 40964, 4505, 4506, 4506F, 4506US, 4507, 4507A, 4507C, 4507F, 4807, 4807A, 4807C, 4807F, 50, 5005, 5006, 5006F, 5006U, 5206, 5206F, 5206U, 5207, 5207A, 5207C, 5207F, 55, 5505, 5506, 5506F, 5506U, 6006, 6006F, 6006U, 6007, 6007A, 6007C, 6007F, 6206, 6206F, 6206U, 6207, 6207A, 6207C, 6207F, 6507, 6507A, 6507C, 6507F, 6806, 6806F, 6806U, 6807, 6807A, 6807C, 6907, 6907C, 7006, 7006F, 7006U, 7007, 7007A, 7007C, 7206, 7206A, 7206F, 7206U, 7207, 7207A, 7207C, 7505, 7505F, 7505U, 7506, 7506F, 7506U, 7807, 7807A, 7807C, 80, 9005, 9005F, 9005U, 9006, 9006A, 9006F, 9006U, AGROCOMPACT 3.30V/F, AGROCOMPACT 3.50S, AGROCOMPACT 3.50V/F, AGROCOMPACT 3.70V/F, AGROCOMPACT 3.90F, AGROCOMPACT 3.90S, AGROLUX 60, AGROLUX 70, AGROLUX 90, AGROPLUS 60, AGROPLUS 70, AGROPRIMA 4.31, AGROPRIMA 4.36, AGROPRIMA 4.46, AGROPRIMA 4.56, AGROPRIMA 6.06, AGROPRIMA 6.16, AGROSTAR 4.61, AGROSTAR 4.71, AGROSTAR 6.11, AGROSTAR 6.31, AGROSTAR 6.61, AGROSUN 100, AGROSUN 120, AGROSUN 140, AGROXTRA 3.57, AGROXTRA 4.07, AGROXTRA 4.17, AGROXTRA 4.47, AGROXTRA 4.57, AGROXTRA 6.07, AGROXTRA 6.17, BF4L 913, BF4L 913T, BF6L 912, BF6L 913, BF6L 913T, DX110, DX110A, DX120, DX120A, DX140, DX140A, DX145, DX145A, DX160, DX160A, DX230, DX230A, DX250, DX250A, DX250V, DX3, DX3.10SC, DX3.10V, DX3.10VC, DX3.3.50V/F, DX3.30SC, DX3.30VC, DX3.50S, DX3.50SC, DX3.50VC, DX3.60SC, DX3.60VC, DX3.65SC, DX3.65VC, DX3.70SC, DX3.70V/F, DX3.70VC, DX3.75VC, DX3.80SC, DX3.90F, DX3.90S, DX3.90SC, DX3.90VC, DX3500, DX36, DX3700, DX3900, DX4.10, DX4.11, DX4.30, DX4.31, DX4.50, DX4.51, DX4.61, DX4.70, DX4.71, DX50, DX55, DX6.05, DX6.06, DX6.10, DX6.30, DX6.50, DX7.10, DX80, DX80A, DX85, DX85A, DX86, DX86A, DX90, DX90A, DX92, DX92A, DXAB 110, DXAB 120, DXAB 145, DXAB 160, DXAB 80, DXAB 85, DXAB 86, DXAB 90, DXAB 92, DXBIS 110, DXBIS 120, DXBIS 140, DXBIS 145, DXBIS 160, DXBIS 85, DXBIS 90, F1L 812, F2L 812, F2L 912, F3L 812, F3L 812D MOT., F3L 812S, F3L 912/912W, F3L 913, F4L 812S, F4L 912, F4L 912/912W MOT., F4L 913, F4L812D MOT., F5L 912/912W, F6L 812D MOT., F6L 912/912W, F6L 913, HOPFEN DX4.17, HOPFEN DX4.57, INTRAC 2002, INTRAC 2003, INTRAC 2004, INTRAC 2005, INTRAC 2006, INTRAC 6.30, INTRAC 6.30T, INTRAC 6.60	04231021, 2100087, 2134511, 2239550, 3363174, 4150197, 4157603, 4167698, 4230294, 4230566, 4231021, KZ0150-17, UC0150-17
93151	52001005		AGROCLIMBER 100,, AGROCLIMBER 105,, AGROCLIMBER 310,, AGROCLIMBER 400,, AGROCLIMBER 410 SIX,, AGROCLIMBER 410,, AGROCLIMBER 70,, AGROCLIMBER 80,, AGROCLIMBER 90,, AGROCOMPACT 70F3,, AGROCOMPACT F100,, AGROCOMPACT F75,, AGROCOMPACT F90,, AGROFARM 100G, AGROFARM 115G,, AGROFARM 410, AGROFARM 415,, AGROFARM 415, AGROFARM 420,, AGROFARM 425, AGROFARM 430,, AGROFARM 80C, AGROFARM 90C,, AGROFARM 85G, AGROFARM 100C,, AGROLUX 100, AGROLUX 4.75,, AGROLUX 4.80, AGROLUX 57,, AGROLUX 67, AGROLUX 77,, AGROLUX 80, AGROLUX 85,, AGROLUX 87, AGROLUX 90,, AGROLUX 95, AGROLUX 97,, AGROMAXX 60, AGROMAXX,, AGROTRAC 100, AGROTRAC 110, AGROTRAC 115, AGROTRAC 130, AGROTRAC 150, AGROTRAC 170,, AGROTRAC 610, AGROTRAC 620, MODELLI AGROPLUS,	2.4519.330.0, 2.4519.330.0/10, 2.4519.330.0/20, 2.4519.330.0/30, 2.4519.330.0/40, 2.4519.330.0/50

Art./Ref.	Tipo BCD/Type BCD	Brand	Applicazione/Application	Rif. Orig./Orig. Ref.
<b>00754</b>	1947/5	<b>FIAT</b>	350, 355, 400, 420, 45-66, 45-66DT, 45-66S, 45-66SDT, 45-76V, 450, 450 DT, 455, 455C, 470, 480, 50-66, 50-66DT, 50-66S, 50-66SDT, 50-86SV, 50-86SVDT, 50-86V, 50-86VDT, 500, 500 DT, 500 DT SPECIAL, 505, 505C, 540, 55-46, 55-46DT, 55-56, 55-56DT, 55-65F, 55-65M, 55-65V, 55-66, 55-66DT LP, 55-66F, 55-66FDT, 55-66LP, 55-66S, 55-66SDT, 55-66V, 55-66VDT, 55-75F, 55-75M, 55-75V, 55-76FDT, 55-76V, 55-76VDT, 55-85F, 55-85M, 55-85V, 55-86F, 55-86FDT, 55-86SV, 55-86SVDT, 55-86V, 55-86VDT, 55-88, 55-88DT, 55-90, 55-90DT, 550, 550 DT, 555, 56-66S, 56-66SDT, 580, 60-46, 60-46DT, 60-56DT, 60-65, 60-65M, 60-65V, 60-66, 60-66DT, 60-66F, 60-66FDT, 60-66LP, 60-66LPDT, 60-66S, 60-66SDT, 60-75, 60-75M, 60-75V, 60-76F, 60-76FDT, 60-85F, 60-85V, 60-86F, 60-86FDT, 60-86SV, 60-86SVDT, 60-86V, 60-86VDT, 60-88, 60-88DT, 60-90, 60-90DT, 60-93, 60-93DT, 60-94, 60-94DT, 600 DT, 600 DT3, 605, 605C, 62-85, 62-85M, 62-86F, 62-86FDT, 640, 640 DT, 65-46, 65-46DT, 65-56, 65-56DT, 65-66, 65-66DT, 65-66S, 65-66SDT, 65-88, 65-88DT, 65-90, 65-90DT, 65-93, 65-93DT, 65-94, 65-94DT, 70-56, 70-56DT, 70-65, 70-65M, 70-66, 70-66DT, 70-66F, 70-66FDT, 70-66LP, 70-66LPDT, 70-66S, 70-66SDT, 70-66V, 70-75, 70-75M, 70-76F, 70-76FDT, 70-76LP, 70-76LPDT, 70-76V, 70-86SV, 70-86SVDT, 70-86V, 70-86VDT, 70-88, 70-88DT, 70-90, 70-90DT, 72-85, 72-85M, 72-86F, 72-86FDT, 72-86LP, 72-86LPDT, 72-93, 72-93DT, 72-94, 72-94DT, 80-65, 80-66, 80-66DT, 80-66F, 80-66FDT, 80-66S, 80-66SDT, 80-75, 80-76F, 80-76FDT, 80-88, 80-88DT, 80-90, 80-90DT, 82-85M, 82-86F, 82-86FDT, 82-86LP, 82-86LPDT, 82-93, 82-93DT, 82-94, 82-94DT, 85-55, 85-90, 85-90DT, 88-85M, 88-93, 88-93DT, 88-94, 88-94DT, OM CARRELLI DI12 - DI15 3 CIL, OM CARRELLI DI20 - DI25 3 CIL, OM CARRELLI DI20C 3 CIL, OM CARRELLI DI25C 3 CIL, OM CARRELLI DI30 - DI35 4 CIL, OM CARRELLI DI30C 3 CIL, OM CARRELLI DI30CH 4 CIL, OM CARRELLI DI35C - DI50 4 CIL, OM CARRELLI DI40 - DI40C 4 CIL, IDROVERT S60, IDROVERT SH 150 8045.25.380, IDROVERT TL5 - TL5H, AD4, FL4, FL4/C, FL4/C MOT. 8035.01.265, FL4/D, FL4/L, IDROVERT TL5, PALA MEC. FL4/D, S60, TL5H	4609596, 4660068, 4667510, 4709283, 4740717, 4740718, 4756678, 4757883, 4757883, 4609596, 4660068, 4667510, 4709283, 4740717, 4740718, 4756678, 4757223, 4757883
<b>03612</b>	1949/5		100-90, 100-90DT, 1000, 1000 SUPER, 1000DT, 1000N, 1000S, 110-90, 110-90DT, 1180, 1180DT, 1280, 1280DT, 666, 670, 680, 780, 805, 855 (6 CIL.), 880, 880-5, 90-90, 90-90DT, 95-55 CRAWLER TRACTOR, 955, 980	4673618, 4709284, 4740719, 4757884
<b>03629</b>	2591		35.66, 35.66 DT	9963402
<b>15395</b>	50043040		FL4	79047864, 8313527, 8331527, MOD763150

<b>00754</b>	1947/5	<b>FORD</b>	3010S, 3435, 3830, 3935, 4010S, 4030, 4135, 4230, 4430, 4635, 4835, 5010S, 5635, 6635, 7635	4757883
<b>03630</b>	1533/2A		D1000 SERIE V8.511 & 511, MOT. 4CIL. CON SIMMS P4594P463, MOT. 4CIL. CON SIMMS P4632/33/, TR. 3000, 5000, 8000, 9000, TR. SUPER DEXTA, SUPER MAJOR 5	510E9350
<b>03639</b>	1858		1118, 2150, 220, 3000, 3055, 3100, 3110, 3120, 3150, 3190, 3300, 3310, 333, 3330, 335, 3400, 3500, 3550, 3600, 5000, 5100, 5110, 5190, 5200, 5340, 5500, 5600, 5610, 5900, 6410, 655, 6550, 655A, 6600, 6600C, 66000, 6610, 66100, 6700, 6710, 6810, 7000, 7100, 7200, 7410, 7550, 7600, 7600C, 7610, 76100, 7700, 7710, 7810, 78100, 7910, 8000, 8200, 8210, 8530, 8600, 8630, 8700, 8730, 8830, 9000, 9200, 9600, 9700, BSD329, BSD438, BSD442, BSD442T, BSD444, BSD444T, BSD666, BSD666T, BSD666TI, MAJOR (DIESEL), POWER MAJOR (DIESEL), SUPER MAJOR (DIESEL), TW10, TW15, TW25, TW35, TW5	83991467, D8NN9350AB
<b>03655</b>	1796		1118, 2150, 220 ENGINE, 3000, 3100, 3120 INDUSTRIAL, 3150, 3150 RICE VERSION, 3190, 3300, 3310, 333 INDUSTRIAL, 3330, 335 INDUSTRIAL, 3400 INDUSTRIAL, 3500, 3500 INDUSTRIAL, 3550, 3600, 5000, 5100, 5110, 5190, 5200, 5340, 5500 BACKHOE LOADER, 5550 INDUSTRIAL, 5610, 5900, 6410, 655 INDUSTRIAL, 6550 INDUSTRIAL, 655A INDUSTRIAL, 6600, 6600C, 6610, 66100, 6700, 6710, 6810, 7000, 7100, 7200, 7410, 7550 INDUSTRIAL, 7600, 7600C, 7610, 76100, 7700, 7710, 7810, 78100, 7910, 8000, 8200, 8210, 8530, 8600, 8630, 8700, 8730, 8830, 9000, 9200, 9600, 9700, BSD329 ENGINE, BSD438 ENGINE, BSD442 ENGINE, BSD442T ENGINE, BSD444 ENGINE, BSD444T ENGINE, BSD666 ENGINE, BSD666T ENGINE, BSD666TI ENGINE, MAJOR, POWER MAJOR, SUPER MAJOR, TW10, TW15, TW20, TW25, TW30, TW35, TW5	510E9350, 81846098, 81859378, 83912071, 83991467, 84749024, D3NN9350A, D8NN9350A, D8NN9350AA, D8NN9350AB

<b>02110</b>	1930/5	<b>HURLIMANN</b>	H6160	2.4519.220.2, 2.4519.230/10, 2.4519.290.0
<b>03674</b>	1991/5 - 2625/1		H305XE, H306XE, H307XE, H356, H358, H358 PRESTIGE, H358.4 CLUB, H361, H361XF, H362, H372, H4105 ELITE, H466, H468, H468 PRESTIGE, H468.4 CLUB, H476, H476 XF, H478, H478 PRESTIGE, H478.4, H481 XF, H486, H488, H488T PRESTIGE, H491 XF, XA606, XA607, XT908, XT909, XT910.4, XT910.6	2.4519.300.0, 2.4519.310.0

<b>03631</b>	1780	<b>INTERMOTOR</b>	MOT. LA400 E DERIVATI, MOT. LA490 E DERIVATI	6585.006
--------------	------	-------------------	--	----------

<b>00754</b>	1947/5	<b>IVECO</b>	8045.06.200 TRATTORE, AIFO 8041.25.200, D.8031.05.30 INDUSTRIAL, D.8035.05.200 INDUSTRIAL, D.8035.05.208 INDUSTRIAL, D.8035.05.265 INDUSTRIAL, D.8035.05.308 INDUSTRIAL, D.8035.05.359 INDUSTRIAL, D.8035.06.240 INDUSTRIAL, D.8035.06.309 INDUSTRIAL, D.8035.06.340 INDUSTRIAL, D.8035.06.342 INDUSTRIAL, D.8035.06.343 INDUSTRIAL, D.8041.05.200 INDUSTRIAL, D.8041.05.206 INDUSTRIAL, D.8041.05.306 INDUSTRIAL, D.8045.05.200 INDUSTRIAL, D.8045.05.201 INDUSTRIAL, D.8045.05.204 INDUSTRIAL, D.8045.05.206 INDUSTRIAL, D.8045.05.207 INDUSTRIAL, D.8045.05.209 INDUSTRIAL, D.8045.05.307 INDUSTRIAL, D.8045.05.322 INDUSTRIAL, D.8045.05.346 INDUSTRIAL, D.8045.05.359 INDUSTRIAL, D.8045.05.370 INDUSTRIAL, D.8045.05.389 INDUSTRIAL, D.8045.06.206 INDUSTRIAL, D.8045.06.320 INDUSTRIAL, D.8045.25.305 INDUSTRIAL, D.8045.25.370 INDUSTRIAL, D.8045.25.375 INDUSTRIAL	4757883
<b>03612</b>	1949/5		8055.05.200 - 8065.05.200, 8055.25.200 (5 CIL.), 8061.25.200 (6 CIL.), 8065.06.200, 8065.25.200 TURBODIESEL, AIFO 8051.05.200	4757884
<b>92937</b>	2723		N45 MNA M10, SERIE NEF	-

Art./Ref.	Tipo BCD/Type BCD	Brand	Applicazione/Application	Rif. Orig./Orig. Ref.
<b>03632</b>	1943	<b>JOHN DEERE</b>	1020 (MOT.3152D ->085099), 1020 (MOT.3164D 085100->), 1030VU, 1035, 1035EF, 1035EV, 1040V, 1130, 1140F, 1140V, 1350, 1445F, 1550, 16300U, 1630VU, 1635, 1635EF, 1635EV, 1640F, 1745F, 1750, 1750V, 1830, 1840F, 1845F, 1850F, 1850N, 1850V, 1950F, 1950N, 2020, 20300U, 2035, 2035EF, 2040F, 2120, 2135, 2150, 2155, 2255, 2345F, 2355, 2450F, 2550, 2555CS, 2555TSS, 2650, 2650CS, 2650F, 2650N, 2650TSS, 2750, 2755, 2840, 2855N, 2940, 2950, 2955, 3030, 3040, 3050, 3055, 3100, 3120, 3155, 3164D, 3179T, 3340, 3640, 3640S, 3650, 4040S, 4202D, 4239D, 510, 6359T, 710, 820, 840, 920, 930, 940V, MOT.3152D, MOT.4202D, MOT.4219D, MOT.6303D, MOT.6359D	461/66, 5507919, AJ52379, AR34415, AR76030, AR77914, AR92776, AR92777, DD13483, DD14195, DD14292, DE16748, DE17836, DE19070, RE37482, RE527115
<b>92928</b>	-	<b>JOHN DEERE</b>	2254, 2256, 2258, L51, L514,, L524, L534, MOTORI POWERTECH 4 CIL.	RE502513
<b>02107</b>	1910/5	<b>LAMBORGHINI</b>	C362, C453, C553, C653 MOT. SAME 3 CIL., C684, C754, C784, R235 MOT. SAME 2 CIL., R654, R660, R854 MOT. SAME 4 CIL.	0.003.8319.6/10, 2.4519.160.0, 2.4519.190.0/10
<b>02110</b>	1930/5		R1056, R653, R754, R854	2.4519.220.2, 2.4519.230/10, 2.4519.290.0
<b>03633</b>	1911/5		R1056 MOT. SAME 6 CIL.	2.4519.140.0, 2.4519.150.0, 2.4519.180.0, 2.4519.200.0/10
<b>03674</b>	1991/5 - 2625/1		105 FORMULA, 1050 PREMIUM, 1060 PREMIUM, 574-60N CROSS, 660-F PLUS, 674-70, 674-70 CROSS, 674-70 GRAND PRIX, 674.5, 774-80, 774-80 GRAND PRIX, 775-F PLUS, 850 PREMIUM, 874-90T, 874-90T GRAND PRIX, 880-F PLUS, 950 PREMIUM, 956-100, 990-F PLUS, C674, C674-70 ERGOMATIC, C774-80 ERGOMATIC, C874-90 ERGOMATIC, CRONO 554-40, CRONO 564-60, CRONO 574-70, HIGH CLEARANCE 90, R1106, R1306, R600, R674, R700, R774, SPRINT 664-60, SPRINT 674-70	2.4519.300.0, 2.4519.310.0
<b>93151</b>	52001005	C110 SIX, CF100, CF100, CF78,, C90, C95, C105, C100, C110,, CF80, CF88, CF90, CF98,, CRONO 55, CRONO 70, CRONO 65,, CRONO 75, CRONO 80, CROSS 100,, CROSS 80, CROSS 90, CV70, CV80, GRAND PRIX 75, GRAND PRIX 95,, PLUS 100F, PLUS 55F, PLUS 70F,, PLUS 75F, PLUS 90F,, R2.56 TARGET, R2.66 TARGET,, R2.56, R2.66, R2.76, R2.86,, R2.60 TARGET, R2.70 TARGET,, R2.76 TARGET, R2.86 TARGET,, R2.80 TARGET, R2.90 TARGET,, R3.100, R3.75, R3.80, R3.85,, R3.90 T TARGET, R3.90 TREND, R3.90, R3.95, R3.105 TB,, R3.95 TB, R3.105T TARGET,, R4.105, R4.110, R4.85, R4.95,, R5.150, R5.140 EVO, R5.160 EVO, REKORD 60, REKORD 70,, REKORD 65, REKORD 75,, REKORD 75.4, REKORD 80.4,, RF100, RF55, RF70, RF75, RF90,, RF80.4, RF60, RF80, RS100,, RS70, RS75, RS90, RS110, RS80,, RV100, RV70, RV75, RV90, RV110, SPIRE 70, SPIRE 80, SPIRE 85	2.4519.330.0, 2.4519.330.0/10, 2.4519.330.0/20, 2.4519.330.0/30, 2.4519.330.0/40, 2.4519.330.0/50	
<b>02106</b>	2567	<b>LANDINI</b>	6550, 6830, 6860, 7830, 7860, 8550, 8830, ADVANTAGE CAB E F.S: 65, ADVANTAGE CAB E F.S: 75, BLIZZARD: 65, BLIZZARD: 75, CINGOLATI: C7830, CINGOLATI:C6830, CINGOLATI:CF6830, FRUTTETI 530 F/L/V: 7530, FRUTTETI 530 F/L/V:6530, FRUTTETI 530 F/L/V:8530, FRUTTETI 560 F/L/V: 6560L/V, FRUTTETI 560 F/L/V: 7560L, R7500 MOT. PERKINS 4.236, TR. R6500, TR. R6550MOT. PERKINS 4.236, TREKKER: C75, TREKKER: CF65, TREKKER: CF70, TREKKER: CF75, VIGNETI CAB E F.S: 65V, VIGNETI CAB E F.S: 75V	3637290M91
<b>02108</b>	1812		4000/DT, 4000R, 4000S, 4500R, 5000/DT, 5000/N, 5000/S, 5000R, 5500, 5500 4RM MOT. PERKINS 3.152, 5830, 5840, 5860, 5870, 6030, 6040, 6060, 6070, ADVANTAGE CAB E F.S: 55, ADVANTAGE CAB E F.S: 60, BLIZZARD: 50, BLIZZARD: 60, C5000, CINGOLATI: C5000, CINGOLATI: C5500, CINGOLATI: C5830, CINGOLATI: CF4830, CINGOLATI: CF5830, CINGOLATI: CF6030, CINGOLATI: CF6060, CINGOLATI:C4500, CINGOLATI:CF5030, FRUTTETI 530/F/L/V: 4530, FRUTTETI 530/F/L/V: 5530, FRUTTETI 530/F/L/V: 6030, FRUTTETI 560 F/L/V: 4560, FRUTTETI 560 F/L/V: 5560, FRUTTETI 560 F/L/V: 6060, GLOBUS: 50, GLOBUS: 55, NEW SERIE 60: 5860, PERKINS D3.152 C5500, REX CAB E F.S: 60, TR. 4500, TREKKER: CF55, TREKKER: CF60, VIGNETI CAB E F.S: 55V, VIGNETI CAB E F.S: 60V, VIGNETI REX CAB: 60V, VIGNETI REX CAB: 65V	3637307M91, 4222111M91
<b>02111</b>	1987		4530V-5530F-5530L-5530-5830, 5500, 5560F-5560L-5560V, 5840-6040, 5860, 5870-6070, 6030-6030F-6030L-6030V, 6060-6060F-6060L-6060V, ADVANTAGE55F-FP-GE-GT-GTP-L-LP, ADVANTAGE60F-FP-GE-GT-GTP-L-LP, BLIZZARD 60, C4830-CF4830, C6030F, CF5030, CF5830, CF6060, GLOBUS 55, TREKKER 60F, VIGNETI 60V	994183, 994295, ULPK0004
<b>03634</b>	1695/1		4000, 4000 SPECIAL, 4530V, 4560V, 5000, 5000 R-S, 5000 SPECIAL, 5000DT, 5000R-N, 5500, 5530F, 5530L, 5530V, 5560F, 5560L, 5560V, 5830, 5840, 5860, 5870, ADVANTAGE 55F, ADVANTAGE 55FP, ADVANTAGE 55GE, ADVANTAGE 55GT, ADVANTAGE 55GTP, ADVANTAGE 55L, ADVANTAGE 55LP, ADVANTAGE 55V, BLIZZARD 50, C4500, C4830, C5500, C5830, CF4830, CF5030, CF5830, GLOBUS 50, MF 244, TREKKER 50F, TREKKER 55F, TREKKER CF55	25061520, ULPK0018
<b>03635</b>	1752/1		6000, 6000 SPECIAL, 6500, 6505, C6000, TR. 6500 MOT. PERKINS 4.203, TR. TL16N MOT. PERKINS D4.203	ULPK0010
<b>03638</b>	1942/1		10000, 12500, 13000, 14500, 16500, 9500, LEGEND 105, LEGEND 115, LEGEND 130, LEGEND 130 BLU, LEGEND 145, LEGEND 160 BLU, LEGEND 165, LEGEND N/G: 115, LEGEND N/G: 120, LEGEND N/G: 130, LEGEND N/G: 180, MYTHOS 110, TR. 10500, 12500, 13500 MOT. P, TR. 12500, 14500, 14500 4RM MO, TR. MF 1100, 1134, 14500 MOT., TR. R9000 MK II, R9500 MK II 4	2641719, 2641720, 2641729, 2641A070, 3641400M91, ULPK0002
<b>03639</b>	1858		6500, 7000 SPECIAL, 8000/DT, 8000R, C6500, TR. 8000 MOT. PERKINS 4.248	ULPK0011
<b>03643</b>	1529/1		4A/203, 6000DT, 6000R, 6000S, 7000R, C6000, TR. 6000 MOT. PERKINS 4A/192	ULPK0009
<b>03646</b>	1687/1		LARGE 10000, TR. MF 1104, R9500 MOT. PERKIN, TR. TL19N/A, R9500 MOT. PERKIN	ULPK0007

Art./Ref.	Tipo BCD/Type BCD	Brand	Applicazione/Application	Rif. Orig./Orig. Ref.
<b>03652</b>	2522/5	<b>LANDINI</b>		ULPK0008
<b>03659</b>	2563		12500, 14500	ULPK0022
<b>14239</b>	1873/5		6500, 6530F, 6530L, 6530V, 6550, 6560L, 6560V, 65F, 65FP, 65GE, 65GT, 65GTP, 65L, 65LP, 6840, 6860, 6870, 6880, 6880VM, 68CV, 7000S, 7500, 7505, 7530F, 7530L, 7550, 7560L, 7560V, 75F, 75FP, 75GE, 75GT, 75GTP, 75L, 75LP, 7830, 7860, 7860HC, 7870, 7880, 7880VM, 78CV, 8500, 8530L, 8550, 8560L, 85FP, 85GE, 85GT, 85LP, 8830, 8860, 8870, 8880, 8880HC, 88CV, 9060, 9080, 9080HC, 9880, 9880HC, ADVANTAGE CAB :L95, ADVANTAGE CAB E F.S:85, BLIZZARD 65, BLIZZARD 75, BLIZZARD:85, BLIZZARD:95, C6830, C7830, CF6830, CINGOLATI :C8860, CINGOLATI: C7800, CINGOLATI:C6500, FRUTTETI 530 F/L/V:8530F, FRUTTETI 560 F/L/V:8560, FRUTTETI 560:6560F, FRUTTETI 560:7560F, GLOBUS 55, GLOBUS 60, GLOBUS 70, REX 90GE, TR. 6400, 6500 MKII, MKII 4RM,, TR. 6830, TR. 7500, TR. 7500 4RM, TR. 8500, TR. 85004RM, TREKKER 65F, TREKKER 70F, TREKKER 75F, TREKKER 80F, TREKKER C75, TREKKER C85, TREKKER CF60, TREKKER CF70, TREKKER CF75, TREKKER CF85, TREKKER:C 95, VIGNETO 65V, VIGNETO 75V	1447017M91, 1447688M91, 2641A053, 2641A073, ULPK0003
<b>40431</b>	2697	6860NG, 7860NG, 8860NG, ATLANTIS 100, ATLANTIS 70, ATLANTIS 75, ATLANTIS 80, ATLANTIS 85, ATLANTIS 90, ATLAS 100, ATLAS 70, ATLAS 75, ATLAS 80, ATLAS 85, ATLAS 90, GHIBLI 100, GHIBLI 80, GHIBLI 90, GLOBUS 65, GLOBUS 75, GLOBUS 80, MHYTOS 100, MHYTOS 90, REX 100FP, REX 100GE, REX 100GTP, REX 70FP, REX 70GE, REX 70GTP, REX 70LP, REX 70V, REX 80FP, REX 80GE, REX 80GTP, REX 80LP, REX 80V, REX 90FP, REX 90GE, REX 90GTP, REX CAB 100, REX CAB 70, REX CAB 80, REX CAB 90, TREKKER 100C, TREKKER 70C, TREKKER 70F, TREKKER 70L, TREKKER 80C, TREKKER 80F, TREKKER 80L, TREKKER 90C, TREKKER 90F, VIGNETI 70V CAB, VIGNETI 80V CAB, VISION 100, VISION 80, VISION 90	2641A052, 2641A067, ULPK0005, ULPK0034	
<b>03612</b>	1949/5	<b>LAVERDA</b>	3300AL, 3560AL	4757884
<b>15395</b>	50043040		3300AL	MOD763150
<b>02109</b>	1927/5	<b>LOMBARDINI</b>	MOT. DIESEL (GR. 5, 7, 9, 10,, MOT. DIESEL LDA 672, LDA 673, MOT. DIESEL LDA 832, LDA 833	276.6585.11, 276.6585.30, 6416.6585.07, 6585.030, 672.6585.030
<b>03616</b>	1928/5		MOT. DIESEL 3LD 450, MOT. DIESEL 500, 503, 505, 507, MOT. DIESEL 520, 523, 525, 527, MOT. DIESEL LD450 GR. 3-4, MOT. DIESEL LDA 80, LDA 80B, M, MOT. DIESEL LDA 96	283.6585.031
<b>03640</b>	1899/5		MOT. DIESEL 8LD 600, 8LD 602 (, MOT. DIESEL 904 E DERIVATI	6585022, 904.6585.022, 904.6585.22
<b>03641</b>	1929/5		MOT. DIESEL 500, 520, 530, (GR, MOT. DIESEL 6LD 260 (GRUPPO 6)	500.6585.032, 6416.6585.27, 6585032
<b>03629</b>	2591			1.046.585.066, 1.046.585.095
<b>02106</b>	2567	<b>MASSEY FERGUSON</b>	11 SHOVEL LOADER MOT. 4.248, 165 COMBINE MOT. 4.212, 168, 168 MK III/168F MOT. 4.236, 168 NARROW MOT. 4.236, 175 175S, 175/178 MOT. 4.236, 178 MOT. 4.248, 178/175S, 185/188 ENG. 248UA71961, 186 COMBINEMOT. 4.212 (, 188, 194 MOT. 4.248, 206, 265, 274, 275 MOT. 4.236, 285, 290 MOT. 4.248, 300, 307 COMB.HARVESTER MOT. 4.236, 33 MOT. 4.248 (2641725), 487 MOT. 4.248 (2641725), 50, 50 PHASE II SKIDMOT. 4., 50B INDUST. TDL, 565, 575 MOT. 4.236, 590 MOT. 4.248, 600 MOT. 4.236, 675, 690, ESCAVATORE MF350, INDUST. MF 30/50 MOT. 4.21, INDUST. MF50 MOT. 4.212, MF 184, MF 194 23 MOT. PERKINS 4.236, TR. MF 174, W350	1447688M91, 3637290M91, 3641402M91, 4222108M91
<b>02108</b>	1812		122, MF 133/135 VIGNETO MO, 134C, 134V, 135 MOT. 3.144, D3.152, 135, 135ET, 135MK III/1, 140, 140/140V/140 MK III/145, 145, 145S, 145V, 148 MK III/152152ET, 152, 148, MF 148/148V MOT. D, 150, 203, 2200 MOT. 3AD, 152, 152F, 152S, 154, 154C, 154F, 154S, 154V, 20, 205, 20B, 20C, 20D, 20E, 2135, 2203, 2205, 230, 233, 234C, 234CF, 234S, 235, 245, 255 MOT. D3.1, 240, 250, 550 MOT.D3.15, 244CF, 253 ITALY, 254, 254C, 254CF, 254S, 30B, 30H, 35, DX35, DX40 HX210 MOT. 3AD., I.C.M. APRILIA MF100C MOT.	3637307M91, 4222111M91, 886062M1
<b>02111</b>	1987		122 MOT. D3.152 O.E. N. 26, 133/135 MOT. D3.152, 135, MF135/2135 MOT. D3, 148 MOT. D3.152, 155, 158F, 158S, 158V, 235, 245, 255 MOT. D3.1, 244, 260, 40B INDUSTRIAL, 550 MOT. D3.152, 560, I.C.M. APRILIA MF 100C MOT, IND. MF 2203-7,2205-7 MOT., TR. MF 244 MOT. PERKINS D3.152	3637322M91, 4222090M91, 4222121M91
<b>03634</b>	1695/1		122 MOT. 3.152, 133, 135 MOT. 3.152, 152UA38570, 135, 203, 205 MOT. A3.152, 135/135ET135MK III/135V, 140, 145, 145S, 148, 150, 152, 152F, 152S, 152V, 154, 154C, 154F, 154S, 154V, 20 INDU-STRIAL, 2135 INDUSTRIAL, 2203 INDUSTRIAL, 2205, 30B INDUSTRIAL, 35, 35X, MF 244	3637288M91, 4222094M91, 885363M91, 890960M1
<b>03635</b>	1752/1		1004, 1080, 1085, 155 AD4.203, 155/158 MOT. 4.318, 158F, 158S, 158V, 165, 195 MOT.4A.318 TR.MF 26, 260, 298, 300, E302F 304, 365, 302, 304, MF 365 MOT. 4AD.20, 3165, 3303, MF3305 MOT. 4AD.20, 3305, 356, 40B, 50, 560 MOT. 4.203, 560 MOT. D4.203, 592 MOT. 4.318, 595 MOT. 4.318, 4.318.2, 598 MOT. 4.318, 65, 698, 70, 765 MOT. 4AD.203, 4AD203	1446155M91, 1447693M91, 2641328, 3637286M91, 3639013M1, 4222107M91, 886100M91
<b>03637</b>	1829/1		630 MOT. 4.107	2641702, 3637979M91
<b>03638</b>	1942/1		1014, 1024, 1114 (U711700L->), 1134, 1250, 2720, MF 350 MOT., 2620, MF 2640, MF 2680, 2625, 2645, 2675, 2685, 2705, 2725, 297, 299, 3080, 3085, 3090, 3095, 3115, 3120, 3120T, 3125, 3140, 3610, 3630, 3635, 3645, 3650, 3660, 396, 399, 4260, 4270, 4360, 6160, 6170, 6180, 6190, 6260, 6270, 6280, 6290, 699, 8110, 8120, 8130, 8220, RX8533C 530, 2620, 2680	1446951M91, 1447535M91, 3641400M91, 4222105M91
<b>03639</b>	1858		165 COMBINE MOT. 4.212, 178, MF185/188 MOT. 4.2, 487 COMBINE MOT. 4.248 MF 5, COMBINE MF 186 MOT. 4.212, DX65 MOT. 4A. 236, INDUST. MF 50 MOT. 4.212, MACCHINA AGRICOLA MF 33 MOT. 4, MACCHINA AGRICOLA MOT. 4.248	1447381M91, 3637287M91, 3637289M91, 4222104M91, 4223471M91



Art./Ref.	Tipo BCD/Type BCD	Brand	Applicazione/Application	Rif. Orig./Orig. Ref.
<b>03643</b>	1529/1	<b>MASSEY FERGUSON</b>	155, 158, 158F, 158S, 158V, 165 MOT. AD4 203, 30 INDUSTRIAL, 302 INDUSTRIAL, 304 INDUSTRIAL, 3165 INDUSTRIAL, 3303 INDUSTRIAL, 3305 INDUSTRIAL, 356 INDUSTRIAL, 50 INDUSTRIAL, 65, MK I-II MOT. P4-4.2, 765, 86-6 COMBINE MOT. 4AD 20, 865, CX65 MOT. 4AD/236	3637338M91, 4222121M91, 4222452M91, 890955M91, 892630M91, 986444
<b>03644</b>	1647/1		155, 158, 158F, 158S, 158V, 165, 30, 302, 304, 3165, 3303, 3305, 356, 400, 410, 50, 65, 765, 865, TR & COMBINES TE 20 MOT. 3.144	35275
<b>03645</b>	1660/1		130 MOT. PERKINS A4/107- A, 25, 30, 825	1446146M91, 1641103M91, 35205, 3637414M91, 4222174M91, 893159M91
<b>03646</b>	1687/1		1014, 1104, 1105, 1135, 1200, 500 COMBINE, 500, MF507, MF525MOT. 6., 515, 520, 620, 625, 740, 750, 760, D400C, MF1200 4 RUOTE MOTR, ESCAVATORE 450C MOT. 6.354/1, ESCAVATORE MF 5400, 620/5, 336, MACCHINA AGRICOLA MF400X/507,	3637309M91, 4222093M91, 892632M91
<b>03652</b>	2522/5		155, 158F, 158S, 158V, 260, 40B INDUSTRIAL, 560	3053177
<b>03655</b>	1796		309D SISU/VALMET, 310B SISU/VALMET, 310D SISU/VALMET, 311C SISU/VALMET, 311CS SISU/VALMET, 411AS SISU/VALMET, 411BS SISU/VALMET, 411C SISU/VALMET, 411CS SISU/VALMET, 411CX SISU/VALMET, 411DS SISU/VALMET	1446184M91, 1446681M91, 1447566M91, 3637289M91, 4223471M91
<b>03659</b>	2563		1114, MF 1134	2641701, 2641710, 2641715, 3637729M91, 4223583M91
<b>14239</b>	1873/5		1007, 168, 168F, 168S, 174, 174C, 174F, 174S, 174V, 175S, 184, 184F, 184S, 185, 188, 194, 194C, 194F, 194S, 273, 284, 284S, 285, 290, 373, 373LX, 373S, 374AP, 374AQ, 377, 383, 387, 393, 394, 396, 397, 50 INDUSTRIAL, 50B INDUSTRIAL, 50B MKII INDUSTRIAL, 50C INDUSTRIAL, 50E, 565, 575, 590, MF 175 DALLA SERIE 236UA57083, MF180 DALLA SERIE 236UA57265, MF184-4, MF255, MF265, MF270MF274-4 TR. SERIE 221N009, MF275, MF294-4 TR. SERIE 223000321, MF670, MF690; INDUSTRIALE:31DALLA SER	1447017M91, 1447688M91, 3637300M91, 3641408M91, 4222091M91
<b>40418</b>			FE35, TEF20	826154M91
<b>40431</b>	2697		2230, 3075, 3220, 3330, 3330V, 3340, 3340GE, 3340S, 3340V, 3350, 3350F/FE, 3350GE, 3350S, 3355, 3355F/FE, 3355GE, 3355S, 374APX, 374FPX, 374GEX, 374SPX, 394APX, 394FPX, 394GEX, 394SPX, 4225, 4225HV, 4235, 4235HV, 4240, 4245, 4245HV, 4255, 4255HV, 4260, 4265, 4325, 4325HV, 4335, 4335HV, 4345, 4345HV, 4355, 4355HV, 4365, 5275, 5285, 5290, 6110, 6120, 6130, 6140, 6150, 6235, 6235HV, 6245, 6245HV, 6255, 6255HV, 6265, 750 FERMEC, 760 FERMEC, 860 FERMEC, 8925 LOADER, 8925T LOADER, 8926 LOADER, 8926T LOADER, 8937 LOADER, 8937T LOADER, 8939 LOADER, 8939T LOADER, 960 FERMEC, 965 FERMEC	2010877, 3055623, 3639696M1, 3641308M91, 4222106M91, 4224451M91, 549553, 601824, 72081, 72111
<b>03638</b>	1942/1	<b>MCCORMICK</b>	MTX110, MTX125, MTX140, MTX155, MTX175, MTX200	ULPK0002
<b>40431</b>	2697		-	295976A1, ULPK0005, ULPK0034
<b>00754</b>	1947/5	<b>NEW HOLLAND</b>	L60, L65, L75, L85, L95, TD55D, TD65D, TD75D, TD85D, TD95D, TK65F, TK65V, TK75F, TK75M, TK75V, TK76, TK76M, TK85, TK85M, TK95M, TL100, TL65, TL70, TL80, TL90, TN55, TN55D, TN55S, TN55V, TN60A, TN60DA, TN60SA, TN65, TN65D, TN65F, TN65N, TN65S, TN65V, TN70D, TN70DA, TN70F, TN70SA, TN75, TN75A, TN75D, TN75DA, TN75F, TN75N, TN75S, TN75SA, TN75V, TN80F, TN90F, TN95F, TN95NA, TN95VA	4757883, 504090935
<b>03612</b>	1949/5		1214 BRAUD, SB52 BRAUD, SB54 BRAUD, SB56 BRAUD, SB58 BRAUD, SB60 BRAUD, SB62 BRAUD, SB64 BRAUD, TK100-55, TK95-55	4757884
<b>92937</b>	2723		T6000 DELTA, T6000 PLUS, TK4060, TL100A, TL70A, TL80A,, TL90A, TN85A, TN85DA, TN85SA,, TN95A, TN95DA, TS100A, TS110A, TS115A, TS130A	84268475
<b>92934</b>	2568	<b>PERKINS</b>	G4.236 PETROL	25061616, 25066419, 2641726, 93151295
<b>02108</b>	1812		3.152, 3AD.152, D3.152, 7 MOT. D3.152	2641309, 2641310, 2641311, 2641317, 2641A063, ULPK0006
<b>02111</b>	1987		AD4.203, D3.152, D3.152 INDUSTRIAL	2641704, 2641712, 2641808, ULPK0004
<b>03634</b>	1695/1		3A.144, 3.152.1, 3.152TA,, A3.144, A3.152, A4.236, AD3.152, MOT. PERKINS 3.152	2641406, 2641408, 35273, ULPK0018
<b>03635</b>	1752/1		A4.318, MOT.4.203, 4.203., A4.318.2, APPLICAZIONI VARIE	2641328, 2641333, 2641336, 32518, ULPK0010
<b>03637</b>	1829/1		4.108 MARINE, A4.108, 4.1	2641702, 2641A058
<b>03638</b>	1942/1		1006.6, 1006.60, 1006.60T, 1006.6T, 6.354.4 - T.6.354.4, A6.354.1	2641719, 2641720, 2641729, 2641A070, ULPK0002
<b>03639</b>	1858		11 MOT. 4.248, 4.212, 4.236, 4.248 (C/PO, APPLICAZIONI VARIE	2641338, 2641477, 2641478, 2641720, ULPK0011
<b>03643</b>	1529/1		A4.192, A4.203, A4.300, AD4.203	2641345, 2641346, 2641A065, 32589, ULPK0009
<b>03644</b>	1647/1		F3 CON SIMMS P4442, P4588, P46, MOT.A4.192, MOT.A4.203, MOT.A4.300, MOT.AD4.203, P3 CON SIMMS P4609 (SPAGNA), P3, P3/144, P3/144TA, 3B/152 V	25061501, 25066421, 258862, 2641A077, ULPK0031

Art./Ref.	Tipo BCD/Type BCD	Brand	Applicazione/Application	Rif. Orig./Orig. Ref.	
<b>03645</b>	1660/1	<b>PERKINS</b>	4/99 A4/107	2641304, 2641305, 2641314, 2641A059, ULPK0017	
<b>03646</b>	1687/1		4/99 MARINE, 6.288, 6.305, 6.354, 6.372, A4.248, A6.354.1, AT6.354.1, AT6.354.4	2641372, 2641374, 2641375, 2641377, 2641A064, ULPK0007	
<b>03652</b>	2522/5		4.203.2, D4.203	2641722, 2641A054, ULPK0008	
<b>03655</b>	1796		V8.510, V8.540, P710	2641469, 2641473 - 2641476, 2641479 - 2641507, 2641481, ULPK0013	
<b>03658</b>	1941/5		4.165 (SPAGNA), 4.165 ALLESTIMENTO VOLKSW	2641706, 2641723, 2641809	
<b>03659</b>	2563		6.354, 6.354.2, T6.354.3, A6.354.4, AT6.354.4	2641701, 2641710, 2641715, 2641A056, ULPK0022	
<b>03660</b>	1796		V8.510, V8.540, P710	2641473 - 2641476, 2641479 - 2641507	
<b>14239</b>	1873/5		A4.212, A4.236, 4.238, A4.248, AT3.152.4, AT4.236	2641711, 2641A053, 2641A073, 7990178, ULPK0003	
<b>40431</b>	2697		1004 4.40	2641A052, 2641A057, 2641A067, ULPK0005, ULPK0034	
<b>03663</b>	1966/5	<b>RUGGERINI</b>	MOT. RD/1, CRD/1, MOT.MOTORIZZATI "FIDO"	652.11, 652.24	
<b>03664</b>	1967/5		MD350, MOT MOTORIZZATI "FIDO P.D.I.", MOT. RD/2, CRD/2, RD180, RD952	652.12, 652.25	
<b>92935</b>	2544		MD 150,151 2a SERIE, MM 190/1	00652R0260, 652.26, 652.27, 652R.026	
<b>02107</b>	1910/5	<b>SAME</b>	AURORA 45, CENTURION 75 EXPORT, CORSARO 70, CORSARO 70 SYNCHRO, CORSARO 70F, DELFINO 32, DELFINO 35, FALCON, MINITAURO, MINITAURO 60, MINITAURO 60 C, SATURNO 80, SATURNO 80 SYNCHRO, SIRENETTA, SIRENETTA 32	0.003.8319.6/10, 2.4519.160.0, 2.4519.190.0/10	
<b>02110</b>	1930/5		BUFFALO 130, CENTURION 75 EXPORT, CONDOR 55 - CONDOR 55 SYNCHRO, CONDOR C, CORSARO 70 - CORSARO 70 FRUTT, CORSARO 70 SYNCHRO, DRAGO 120, JAGUAR 95, LASER 90-100-110-130-150, LEOPARD 85 - LEOPARD 85 EXPORT, LEOPARD 90, MERCURY 85 - MERCURY 85SP, MINITAURO 60 - MINITAURO 60 C, MINITAURUS 60, PANTHER 90, TAURUS 60 - TAURUS C, TIGER SIX 105 - TIGER 100	2.4519.220.0, 2.4519.230.0/10, 2.4519.290.0	
<b>03633</b>	1911/5		BUFFALO 120 - BUFFALO 130, CORSARO 70 - CORSARO 70 FRUTT, CORSARO 70 SYNCHRO, DRAGO 100 - DRAGO 120, LEOPARD 85 - LEOPARD 85 EXPORT, LEOPARD 90, MINITAURO - MINITAURO 60, MINITAURO 60 C, PANTHER 88 - PANTHER 90, PANTHER 95, SATURNO 80 - SATURNO 80 SY, TIGER 50 - TIGER 60, TIGER 70 - TIGER 100	2.4519.120.0, 2.4519.140.0, 2.4519.150.0, 2.4519.180.0, 2.4519.200.0/10	
<b>03670</b>	1681/5		TR. ATLANTA 45, TR. CENTAURO 60, LEONE 70	2.4519.130.0	
<b>03671</b>	1770/5		ATLANTA 45, CENTAURO 55 - 60, CENTAURO 70 EXPORT, CENTAURO 70 SPECIAL, ITALIA 35, LEONE 70 - 75	2.4519.010.0	
<b>03672</b>	1771/5		TR. SAMETTO, SAMITALIA	2.4519.020.0	
<b>03674</b>	1991/5 - 2625/1		ANTARES 110, ANTARES 110 II, ANTARES 130, ANTARES 130 II, ARGON 50, ARGON 60, ARGON 70, ASTER 60, ASTER 70, DORADO 60, DORADO 70, EXPLORER 55, EXPLORER 60, EXPLORER 60 II, EXPLORER 60 SPECIAL, EXPLORER 60SPECIAL II, EXPLORER 65, EXPLORER 65 SPECIAL, EXPLORER 70, EXPLORER 70 II, EXPLORER 70 SPECIAL, EXPLORER 70C, EXPLORER 70SPECIAL II, EXPLORER 75, EXPLORER 75 SPECIAL, EXPLORER 80, EXPLORER 80 II, EXPLORER 80 SPECIAL, EXPLORER 80C, EXPLORER 80SPECIAL II, EXPLORER 85, EXPLORER 90, EXPLORER 90 SPECIAL, EXPLORER 90C, EXPLORER 90T II, EXPLORER 95, FRUTTETO 60, FRUTTETO 60 II, FRUTTETO 75 II, FRUTTETO 85 II, GOLDEN 60, GOLDEN 65, GOLDEN 75, GOLDEN 85, MOT. 916.A-W, 065.1600.0, ROWCROP 100, ROWCROP 100.6, ROWCROP 90, RUBIN 120, RUBIN 135, RUBIN 150, RUBIN 160, RUBIN 180, RUBIN 200, SILVER 100.4, SILVER 100.6, SILVER 80, SILVER 90, TITAN 150, TITAN 160, TITAN 165, TITAN 190, VIGNERON 62, VIGNERON 75	2.4519.300.0, 2.4519.310.0	
<b>93151</b>	52001005		ARGON 55 CLASSIC, ARGON 55F, ARGON 70 CLASSIC, ARGON 70F, ARGON3 65, ARGON3 75, ARGON3 75P, DORADO 56, DORADO 100F, DORADO 55F, DORADO 66 CLASSIC, DORADO 66, DORADO 76, DORADO 70F, DORADO 75F, DORADO 70S, DORADO 75S, DORADO 70V, DORADO 75V, DORADO 76 CLASSIC, DORADO 86 CLASSIC, DORADO 86, DORADO 56 CLASSIC, DORADO 90F, DORADO 100S, DORADO 90S, DORADO 100V, DORADO 90V, DORADO3 100 HILINE, DORADO3 60, DORADO3 80, DORADO3 70 CLASSIC, DORADO3 80 CLASSIC, DORADO3 90 CLASSIC, DORADO3 90, DORADO3 60 CLASSIC, EXPLORER 100, EXPLORER 75, EXPLORER 75T, EXPLORER 75TB, EXPLORER 80, EXPLORER 85, EXPLORER 85T, EXPLORER 85TB, EXPLORER 90, EXPLORER 95, EXPLORER 95T, EXPLORER 95TB, EXPLORER3 105T, EXPLORER3 90T, FRUTTETO 3 S100, FRUTTETO3 S90, FRUTTETO II 100, FRUTTETO II 55, FRUTTETO II 70, FRUTTETO II 75, FRUTTETO II 90, FRUTTETO3 100 CLASSIC, FRUTTETO3 100, FRUTTETO3 80, FRUTTETO3 60 CLASSIC, FRUTTETO3 70 CLASSIC, FRUTTETO3 80 CLASSIC, FRUTTETO3 80.4 CLASSIC, FRUTTETO3 90 CLASSIC, FRUTTETO3 90, FRUTTETO3 V100, FRUTTETO3 V80, FRUTTETO3 V90, KRYPTON 100, KRYPTON 105, KRYPTON 90, KRYPTON 95, KRYPTON F100, KRYPTON F78, KRYPTON F80, KRYPTON F88, KRYPTON F90, KRYPTON F98, KRYPTON V70, KRYPTON V80, LASER 100, LASER 110, LASER 130, LASER 150, SILVER 105, SILVER 110, SILVER 115, SILVER 130, SILVER 85, SILVER 95, TIGER 60, TIGER 70, TIGER 75.4, TIGER 65,	2.4519.330.0, 2.4519.330.0/10, 2.4519.330.0/20, 2.4519.330.0/30, 2.4519.330.0/40, 2.4519.330.0/50	
<b>V2.4519.500.0</b>					2.4519.500.0

Art./Ref.	Tipo BCD/Type BCD	Brand	Applicazione/Application	Rif. Orig./Orig. Ref.
03675	1666/5	SLANZI	DVA 1000	
03676	1837/5		DVA 1550, DVA 460	4850.030, 4850.037
03677	1838/5		DVA 1550 S2, 1750S, 2700,, DVA 3600 TB, 2350, DVA 460, 515, 1500, 1750	4850.034, 4850.038, 4850.041, 4850.046, 4850.34 - 4850.38, 4850.41 - 4850.46
03678	1839/5		DVA 700, 790, 920, 1030	4850.036, 4850.039, 4850.042

03675	1666/5	VMMOTORI	MOT. 100 SL, MOT. 104, 106 SU, MOT. 954, 956 SU	1.518.004, 3.518.0002A, 3.518.001
03681	1860/5		MOT. 295 E DERIVATI, MOT. 395 E DERIVATI, MOT. 395 INDUSTRIALE	1.518.0007, 1.518.0009, 1.518.007, 1.518.009, 8.500.128
03682	1861/5		MOT. 102 SU-103 SU, MOT. 104 SU/T, 2, 3, 4 CIL., MOT. 952 SU, 953 SU	1.518.0010, 1.518.003, 1.518.006, 1.518.010, 8.500.121
03683	1920/5		MOT. HR 488, HR 488H, HR 488HT, MOT. HR 588, HR 588H, HR 588 H, MOT. HR494HPT,494HID,494HT	1.518.0015A, 1.518.014, 1.518.015
03684	1921/5		MOT. HR 292, HR 392H, HR 288,	1.518.0016A, 1.518.012, 1.518.016
03685	2521/5		MOT. HR 292, HR 292H, HR 292HT, MOT. HR 294, HR 294H, HR 294HT	1.518.2001A
03691	1958/5		MOT. 298 S.U.	1.518.0018A
03692	1959/5		MOT. 2, 3, 4 CIL. S.U. -SUN	1.518.0017A
03693	1971/5		MOT. HR 388, HR 388H, HR 388HT, MOT. HR 392, HR 392H, HR 392HT, MOT. HR 492 LEYLAND	1.518.0019A

**POMPE NAFTA ALTA QUALITA'**

POMPE GASOIL HAUTE QUALITE'  
 NAPHTHA PUMP HIGH QUALITY  
 DIESELKRAFTSTOFFPUMPE HIGH QUALITY  
 BOMBA NAFTA ALTA CALIDAD



Art./Ref.	Descrizione estesa/Extended Description	Note/Notes
00754TOP	Pompa nafta a membrana adattabile al rif. Fiat 4757883 ad alta qualità	Riferimenti originali e applicazioni vedere codice ama 00754/ Original references and applications see ama code 00754
02106TOP	Pompa nafta a membrana adattabile al rif. Massey Ferguson 3637290M91 ad alta qualità	Riferimenti originali e applicazioni vedere codice ama 02106/ Original references and applications see ama code 02106
02107TOP	Pompa nafta a membrana adattabile al rif. Same 0.003.8319.6/10 ad alta qualità	Riferimenti originali e applicazioni vedere codice ama 02107/ Original references and applications see ama code 02107
02108TOP	Pompa nafta a membrana adattabile Perkins 2641311 alta qualità	Riferimenti originali e applicazioni vedere codice ama 02108/ Original references and applications see ama code 02108
02109TOP	Pompa nafta a membrana adattabile Lombardini 6585.030 alta qualità	Riferimenti originali e applicazioni vedere codice ama 02109/ Original references and applications see ama code 02109
02110TOP	Pompa nafta a membrana adattabile al rif. Same 2.4519.230.0/10 ad alta qualità	Riferimenti originali e applicazioni vedere codice ama 02110/ Original references and applications see ama code 02110
02111TOP	Pompa nafta a membrana adattabile Perkins 2641311 alta qualità	Riferimenti originali e applicazioni vedere codice ama 02111/ Original references and applications see ama code 02111
03612TOP	Pompa nafta a membrana adattabile al rif. Fiat 4757884 ad alta qualità	Riferimenti originali e applicazioni vedere codice ama 03612/ Original references and applications see ama code 03612
03613TOP	Pompa nafta a membrana adattabile al rif. Carraro 30332/30333 ad alta qualità	Riferimenti originali e applicazioni vedere codice ama 03613/ Original references and applications see ama code 03613

Art./Ref.	Descrizione estesa/Extended Description	Note/Notes
<b>03616TOP</b>	Pompa nafta a membrana adattabile Lombardini 6585.031 alta qualità	Riferimenti originali e applicazioni vedere codice ama 03616/ Original references and applications see ama code 03616
<b>03629TOP</b>	Pompa nafta a membrana adattabile a Fiat rif. 9963402 alta qualità	Riferimenti originali e applicazioni vedere codice ama 03629/ Original references and applications see ama code 03629
<b>03630TOP</b>	Pompa nafta a membrana adattabile a Ford rif. 510E350 alta qualità	Riferimenti originali e applicazioni vedere codice ama 03630/ Original references and applications see ama code 03630
<b>03631TOP</b>	Pompa nafta a membrana adattabile a Intermotor rif. 6585.006 alta qualità	Riferimenti originali e applicazioni vedere codice ama 03631/ Original references and applications see ama code 03631
<b>03632TOP</b>	Pompa nafta a membrana adattabile J.Deere AR92777 alta qualità	Riferimenti originali e applicazioni vedere codice ama 03632/ Original references and applications see ama code 03632
<b>03633TOP</b>	Pompa nafta a membrana adattabile Same 2.4519.120.0 alta qualità	Riferimenti originali e applicazioni vedere codice ama 03633/ Original references and applications see ama code 03633
<b>03634TOP</b>	Pompa nafta a membrana adattabile Perkins 2641406 alta qualità	Riferimenti originali e applicazioni vedere codice ama 03634/ Original references and applications see ama code 03634
<b>03635TOP</b>	Pompa nafta a membrana adattabile Perkins 2641328 alta qualità	Riferimenti originali e applicazioni vedere codice ama 03635/ Original references and applications see ama code 03635
<b>03637TOP</b>	Pompa nafta a membrana adattabile Perkins 2641702 alta qualità	Riferimenti originali e applicazioni vedere codice ama 03637/ Original references and applications see ama code 03637
<b>03638TOP</b>	Pompa nafta a membrana adattabile Perkins 2641720 alta qualità	Riferimenti originali e applicazioni vedere codice ama 03638/ Original references and applications see ama code 03638
<b>03639TOP</b>	Pompa nafta a membrana adattabile a Perkins rif. 2641478 alta qualità	Riferimenti originali e applicazioni vedere codice ama 03639/ Original references and applications see ama code 03639
<b>03640TOP</b>	Pompa nafta a membrana adattabile Lombardini 6585.022 alta qualità	Riferimenti originali e applicazioni vedere codice ama 03640/ Original references and applications see ama code 03640
<b>03641TOP</b>	Pompa nafta a membrana adattabile Lombardini 6585.032 alta qualità	Riferimenti originali e applicazioni vedere codice ama 03641/ Original references and applications see ama code 03641
<b>03643TOP</b>	Pompa nafta a membrana adattabile Perkins ULPK0009 alta qualità	Riferimenti originali e applicazioni vedere codice ama 03643/ Original references and applications see ama code 03643
<b>03644TOP</b>	Pompa nafta a membrana adattabile Perkins ULPK0031 alta qualità	Riferimenti originali e applicazioni vedere codice ama 03644/ Original references and applications see ama code 03644
<b>03645TOP</b>	Pompa nafta a membrana adattabile Massey F: 35205 alta qualità	Riferimenti originali e applicazioni vedere codice ama 03645/ Original references and applications see ama code 03645
<b>03646TOP</b>	Pompa nafta a membrana adattabile Perkins ULPK0007 alta qualità	Riferimenti originali e applicazioni vedere codice ama 03646/ Original references and applications see ama code 03646
<b>03652TOP</b>	Pompa nafta a membrana adattabile Perkins 2641722 alta qualità	Riferimenti originali e applicazioni vedere codice ama 03652/ Original references and applications see ama code 03652
<b>03655TOP</b>	Pompa nafta a membrana adattabile a Perkins rif. ULPK0013 alta qualità	Riferimenti originali e applicazioni vedere codice ama 03655/ Original references and applications see ama code 03655
<b>03658TOP</b>	Pompa nafta a membrana adattabile Perkins 2641809 alta qualità	Riferimenti originali e applicazioni vedere codice ama 03658/ Original references and applications see ama code 03658
<b>03659TOP</b>	Pompa nafta a membrana adattabile Perkins 2641710 alta qualità	Riferimenti originali e applicazioni vedere codice ama 03659/ Original references and applications see ama code 03659
<b>03663TOP</b>	Pompa nafta a membrana adattabile Lombardini 652.11 alta qualità	Riferimenti originali e applicazioni vedere codice ama 03663/ Original references and applications see ama code 03663
<b>03664TOP</b>	Pompa nafta a membrana adattabile Ruggerini 652.12 alta qualità	Riferimenti originali e applicazioni vedere codice ama 03664/ Original references and applications see ama code 03664
<b>03670TOP</b>	Pompa nafta a membrana adattabile Same 2.4519.130.0 alta qualità	Riferimenti originali e applicazioni vedere codice ama 03670/ Original references and applications see ama code 03670
<b>03671TOP</b>	Pompa nafta a membrana adattabile Same 2.4519.010.0 alta qualità	Riferimenti originali e applicazioni vedere codice ama 03671/ Original references and applications see ama code 03671
<b>03672TOP</b>	Pompa nafta a membrana adattabile Same 2.4519.020.0 alta qualità	Riferimenti originali e applicazioni vedere codice ama 03672/ Original references and applications see ama code 03672
<b>03674TOP</b>	Pompa nafta a membrana adattabile a rif. Same 2.4519.310.0 ad alta qualità	Riferimenti originali e applicazioni vedere codice ama 03674/ Original references and applications see ama code 03674
<b>03675TOP</b>	Pompa nafta a membrana adattabile VM 3.518.00002A alta qualità	Riferimenti originali e applicazioni vedere codice ama 03675/ Original references and applications see ama code 03675
<b>03676TOP</b>	Pompa nafta a membrana adattabile al rif. Fiat 4850.037 ad alta qualità	Riferimenti originali e applicazioni vedere codice ama 03676/ Original references and applications see ama code 03676
<b>03677TOP</b>	Pompa nafta a membrana adattabile Slanzi 4850.041 alta qualità	Riferimenti originali e applicazioni vedere codice ama 03677/ Original references and applications see ama code 03677
<b>03678TOP</b>	Pompa nafta a membrana adattabile Slanzi 4850.039 alta qualità	Riferimenti originali e applicazioni vedere codice ama 03678/ Original references and applications see ama code 03678

Art./Ref.	Descrizione estesa/Extended Description	Note/Notes
<b>03680TOP</b>	Pompa nafta a membrana adattabile al rif. VM Motori 1.518.2005A alta qualità	Riferimenti originali e applicazioni vedere codice ama 03680/ Original references and applications see ama code 03680
<b>03681TOP</b>	Pompa nafta a membrana adattabile VM 1.518.0009 alta qualità	Riferimenti originali e applicazioni vedere codice ama 03681/ Original references and applications see ama 03681
<b>03682TOP</b>	Pompa nafta a membrana adattabile VM 1.518.0010 alta qualità	Riferimenti originali e applicazioni vedere codice ama 03682/ Original references and applications see ama 03682
<b>03683TOP</b>	Pompa nafta a membrana adattabile VM 1.518.0015a alta qualità	Riferimenti originali e applicazioni vedere codice ama 03683/ Original references and applications see ama 03683
<b>03684TOP</b>	Pompa nafta a membrana adattabile VM 1.518.0016A alta qualità	Riferimenti originali e applicazioni vedere codice ama 03684/ Original references and applications see ama 03684
<b>03685TOP</b>	Pompa nafta a membrana adattabile VM 1.5182001A alta qualità	Riferimenti originali e applicazioni vedere codice ama 03685/ Original references and applications see ama 03685
<b>03691TOP</b>	Pompa nafta a membrana adattabile VM 1.518.0018A alta qualità	Riferimenti originali e applicazioni vedere codice ama 03691/ Original references and applications see ama 03691
<b>03692TOP</b>	Pompa nafta a membrana adattabile VM 1.518.0017A alta qualità	Riferimenti originali e applicazioni vedere codice ama 03692/ Original references and applications see ama 03692
<b>03693TOP</b>	Pompa nafta a membrana adattabile VM 1.518.0019A alta qualità	Riferimenti originali e applicazioni vedere codice ama 03693/ Original references and applications see ama 03693
<b>14239TOP</b>	Pompa nafta a membrana adattabile Perkins 2641A053 alta qualità	Riferimenti originali e applicazioni vedere codice ama 14239/ Original references and applications see ama code 14239
<b>40431TOP</b>	Pompa nafta a membrana adattabile al rif. Massey Ferguson 4222106M91 ad alta qualità	Riferimenti originali e applicazioni vedere codice ama 40431/ Original references and applications see ama code 40431





### POMPE CARBURANTE ELETTRICHE

POMPES ÉLECTRIQUES CARBURANT

ELECTRIC FUEL PUMPS

ELEKTRISCHE KRAFTSTOFFPUMPEN

BOMBAS DE COMBUSTIBLE ELÉCTRICAS

Art./Ref.	Volt	Bar	Portata lt/min/Lt/Min flow rate	Attacco IN/IN Connection	Attacco OUT/OUT Connection	Immagine/Image
<b>92929</b>	12	0,4	2,16	1/8 x 18 NPTF	1/8 x 18 NPTF	
<b>92930</b>	12	0,4	2,16	1/4 x 18 NPTF	1/4 x 18 NPTF	
<b>92931</b>	24	0,30	2,08	8 mm - girevole di circa 220°	8 mm - girevole di circa 220°	
<b>92932</b>	24	0,15	2,25	8 mm - girevole di circa 220°	8 mm - girevole di circa 220°	

**POMPE NAFTA ELETTRICHE ADATTABILI**

POMPES GASOIL ÉLECTRIQUE ADAPTABLE  
ELECTRIC FUEL PUMP ADAPTABLE  
ELEKTRISCH KRAFTSTOFFPUMPE PASSEND ZU  
BOMBAS NAFTA ELÉTRICA ADAPTABLE

Art./Ref.	Bar/Bar	Brand	Applicazione/Application	Rif. Orig./Orig. Ref.	
92925	0,69	<b>CASE</b>	MXM120, MXM130, MXM135, MXM140, MXM150, MXM155, MXM165, MXM175, MXM180, MXM190	8732768	
		<b>FIAT</b>	M100, M115, M135, M160	87802202	
		<b>NEW HOLLAND</b>	7010S, 7610S, 8010S, 8160,, 8260, 8360, TM110, TM115, TM120, TM125,, TM130, TM135, TM140, TM150,, TM155, TM165, TM175, TM180,, TM190, TS90, TS100, TS110,, TS115, TS115, 5610S, 6610S, 6810S,	87802202	

Art./Ref.	Volt	Bar	Portata lt/min/Lt/Min flow rate	Attacco IN/IN Connection	Attacco OUT/OUT Connection	Lunghezza mm/Lenght mm	Ø mm/Ø mm	Brand	Applicazione/Application	Rif. Orig./Orig. Ref.	Immagine/Image
92926	12	0,24	1,75	19 mm	9 mm	97	36	<b>JOHN DEERE</b>	6010, 6020, 6100, 6110L, 6200,, 6120, 6210, 6220, 6310, 6320,, 6300, 6215, 6310L, 6310S, 6400, 6410L, 6410S, 6500L, 6506,, 6510, 6520, 6610, 6620, 6810,, 6510L, 6510S, 6600, 6605, 6800, 6820, 6910, 6910S, 6920, 6920S, 6900	AL113125, AL78405, AL81173	

Art./Ref.	Portata lt/min/Lt/Min flow rate	Volt	Brand	Applicazione/Application	Rif. Orig./Orig. Ref.	
92927	2,33	13,5	<b>LANDINI</b>	POWERMONDIAL 100,, POWERMONDIAL 105,, POWERMONDIAL 110,, POWERMONDIAL 115, TREKKER 100F, TREKKER 105F, TREKKER 80F, TREKKER 90F,	4132A014, 4132A018, 4226484M1, ULPK0038	
		13,5	<b>PERKINS</b>	MOTORI SERIE 1104 TIPO NK, NL,, NM, RE, RF, RG, RH, RJ, RK, RR, RS, RT	ULPK0038	
PK4132A012	-	-	<b>PERKINS</b>	DC - 1103C -33, DD - 1103C - 33T	4132A012, ULPK0039	

**SERBATOIO NAFTA ADATTABILE E ORIGINALE**

RESERVOIR ADAPTABLE E ORIGINAL  
FUEL TANK ADAPTABLE AND ORIGINAL  
KRAFTSTOFFTANK PASSEND ZU UND ORIGINAL  
TANQUE DE COMBUSTIBLE ADAPTABLE Y ORIGINALE



Art./Ref.	Brand	Applicazione/Application	Rif. Orig./Orig. Ref.
93014	<b>FIAT</b>	450, 480/R, 605C, 640, 640/R	4952764, 4979546, 5011577, 5101893
11272	<b>MASSEY FERGUSON</b>	SERIE 135	897390M91, 897401M92
<b>ORIGINAL</b> V0.170.6673.4	<b>SAME</b>		0.170.6673.4

## TAPPO SERBATOIO CARBURANTE ADATTABILE

BUCHON RESERVOIR CARBURANT ADAPTABLE

FUEL TANK PLUG ADAPTABLE TO

KRAFTSTOFFTANK PFROPFEN PASSEND ZU

TAPON DEPOSITO CARBURANTE ADAPTABLE

Art./Ref.	Brand	Applicazione/Application	Rif. Orig./Orig. Ref.	Immagine/Image
08486		300, 440, 450, 455, 480, 500, 505, 540, 605, 640, 650, 655, 750, 805	4062251, 4062252, 4117122, 44901657, 4988782, 5118532	
08488		100, 110, 115, 1180, 1280, 130, 1300, 1380, 140, 1580, 160, 180, 1880, 446, 565, 570, 580, 665, 670, 680, 72.86, 765, 780, 855, 880, 955, 980, SERIE 66, SERIE 76, SERIE 86, SERIE 88, SERIE 90, SERIE 93, SERIE 94	4181662, 5105346, 700706814, 9960827, 5105346	
08485	FIAT	1000, 215, 315, 415, 446, 465, 466, 55.46-55.46 DT, 55.56-55.56 DT, 55.66-55.66 DT, 55.66S-55.66S DT, 565, 566, 60.46-60.46 DT, 60.56-60.56 DT, 60.66-60.66 DT, 60.66S-60.66S DT, 615, 65.46-65.46 DT, 65.56-65.56 DT, 65.66-65.66 DT, 65.66S-65.66S DT, 665, 666, 70.56-70.56 DT, 70.66-70.66 DT, 70.66S-70.66S DT, 715, 765, 766, 80.66-80.66 DT, 80.66S-80.66S DT, 850	5123779, 5139618, 588974, 592145	
15108		211, 250, 300, 311C, 355C, 411, 411C, 450, 480, 500, 540, 550, 555C, 605C, 640, 640.DT, 650, 655C, 750	4117122, 563366	
27571		115.90-115.90 DT, 130.90-130.90 DT, 140.90-140.90 DT, 160.90-160.90 DT, 180.90-180.90 DT, 35.66-35.66 DT	5115440, 5115440	
08488		4030-4230-4430	5105346	
17187	FORD	2000,2310,2600,2610,2810,2910, 3000,3055,3600,3610,3900,3910, 4100,4110 SENZA CABINA, 5000,5600,5610,5900,6600,6610, 7000,7600,7610 SENZA CABUNA	83961128, E7NN9030AA	
71433	LANDINI	10000, 13000, 6550, 7550, 8550 (DAL 22500086), 8550 (FINO A 22500085), CINGOLATI:C4830, CINGOLATI:C5830, CINGOLATI:C6830, CINGOLATI:C7830, CINGOLATI:C8860, CINGOLATI:CF4830, CINGOLATI:CF5030, CINGOLATI:CF5830, CINGOLATI:CF6030, CINGOLATI:CF6060, CINGOLATI:CF6830, FRUTTETI 530 F/L/V: 7530F PRIM, FRUTTETI 530 F/L/V:5530F PRIMA, FRUTTETI 530 F/L/V:6530F PRIMA, FRUTTETI 530 F/L/V:8530F PRIMA	3300019M91	
11276	MASSEY FERGUSON	1100 A6.354, 1200 A6.354.1, 135,148,230,240 AD3.152, 155,158,165 AD4.203, 165 A4.212, 168,175,265,275,565, A4.236, 178,185,188,285, A4.248, 250,550 AD3.152, 285,290,590,960 A4.248, 298,595,698 A4.138, 35 A3.152, 399 A6.354.4, 575,675 A4.236, 65,765 A4.192, 65,765 A4.203, 698T AT4.236	16098042M91, 1698042M91, 828583M91	
08488		SERIE TK 55 - 65 - 75 - 85	5105346	
27571	NEW HOLLAND	SERIE TK, T4020-T4030-T4040-T4050, TN55, TN55D, TN55S, TN65, TN65D, TN65S, TN70, TN70D, TN70S, TN75, TN75D, TN75S	5115440	

**RUBINETTI PER SERBATOI BENZINA E PETROLIO ADATTABILI**

ROBINETS POUR RESERVOIR ESSENCE ET PETROLE ADAPTABLE POUR

TAPS FOR FUEL AND PETROL TANKS ADAPTABLE TO

KUGELHAHN FÜR TANKS BENZIN UND ERDOL PASSEND ZU

LLAVE PARA DEPOSITO GASOLINA Y PRTROLEO ADAPTABLE

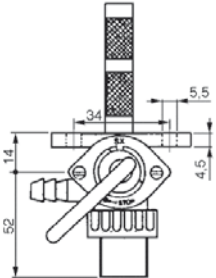
Art./Ref.	Attacco Serbatoio/ Tank attack	Attacco Inferiore Codolo/ Lower tang attack	Riserva Carburante/ Low fuel	Brand	Immagine/Image
05089	Flangia interasse 34 mm	Ø 8 mm.	No	ACME	

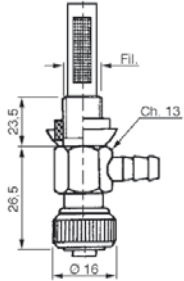
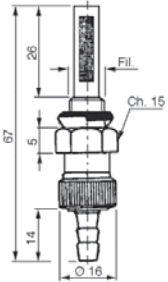
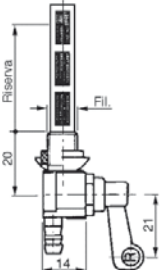
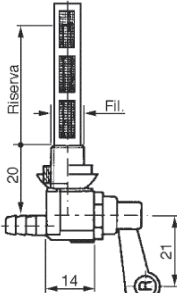
05080	Filetto M10x1	Ø 6 mm.	No	BENASSI	
05081	Filetto M10x1	Ø 6 mm.	No		
05083	Filetto M10x1	Ø 6 mm.	Si		
05084	Filetto M10x1	Ø 6 mm.	Si		



Art./Ref.	Attacco Serbatoio/ Tank attack	Attacco Inferiore Codolo/ Lower tang attack	Riserva Carburante/ Low fuel	Brand	Immagine/Image
05086	Filetto M10x1	Ø 6 mm.	Si	BENASSI	
05081	Filetto M10x1	Ø 6 mm.	No	BRUMITAL	
05082	Filetto M10x1	Ø 6 mm.	No		
05083	Filetto M10x1	Ø 6 mm.	Si		
05084	Filetto M10x1	Ø 6 mm.	Si		
05082	Filetto M10x1	Ø 6 mm.	No	CARPI	

Art./Ref.	Attacco Serbatoio/ Tank attack	Attacco Inferiore Codolo/ Lower tang attack	Riserva Carburante/ Low fuel	Brand	Immagine/Image
<b>05082</b>	Filetto M10x1	Ø 6 mm.	No	<b>CIFARELLI</b>	
<b>05081</b>	30 mm	Ø 6 mm.	No	<b>CM MOTORI</b>	
<b>05082</b>	Filetto M10x1	Ø 6 mm.	No	<b>EFCO</b>	
<b>05082</b>	Filetto M10x1	Ø 6 mm.	No	<b>FOX</b>	
<b>05090</b>	Filetto M10x1 conico	Ø 9 mm.	No	<b>INTERMOTOR</b>	
<b>05091</b>	Filetto M10x1 conico	1 via Ø 6 mm.	No		

Art./Ref.	Attacco Serbatoio/ Tank attack	Attacco Inferiore Codolo/ Lower tang attack	Riserva Carburante/ Low fuel	Brand	Immagine/Image
05092	Filetto M10x1 conico	2 vie Ø 6 mm.	No	INTERMOTOR	
05093	Fissaggio con bullone 6 MA	Ø 9 mm.	No		
05094	Fissaggio con bullone 6 MA	Ø 9 mm.	No		
05090	Filetto M10x1 conico Rif. Orig. 7755.055	Ø 9 mm.	No	LOMBARDINI	
05091	Filetto M10x1 conico Rif. Orig. 7755.053	1 via Ø 6 mm.	No		
05092	Filetto M10x1 conico Rif. Orig. 7755.062	2 vie Ø 6 mm.	No		
05093	Fissaggio con bullone 6 MA Rif. Orig. 7755.063	Ø 9 mm.	No		

Art./Ref.	Attacco Serbatoio/ Tank attack	Attacco Inferiore Codolo/ Lower tang attack	Riserva Carburante/ Low fuel	Brand	Immagine/Image
<b>05094</b>	Fissaggio con bullone 6 MA Rif. Orig. 7755.060	Ø 9 mm.	No	<b>LOMBARDINI</b>	
<b>05080</b>	Filetto M10x1	Ø 6 mm.	No	<b>MAB</b>	
<b>05085</b>	Filetto M12x1	Ø 6 mm.	Si		
<b>05086</b>	Filetto M10x1	Ø 6 mm.	Si		
<b>05080</b>	Filetto M10x1	Ø 6 mm.	No	<b>MINARELLI</b>	
<b>05081</b>	Filetto M10x1	Ø 6 mm.	No		

Art./Ref.	Attacco Serbatoio/ Tank attack	Attacco Inferiore Codolo/ Lower tang attack	Riserva Carburante/ Low fuel	Brand	Immagine/Image
05086	Filetto M10x1	Ø 6 mm.	Si	MINARELLI	
05080	Filetto M10x1	Ø 6 mm.	No	MIRA	

**RUBINETTO CARBURANTE ADATTABILE FIAT**

ROBINET CARBURANT ADAPTABLE FIAT  
 FUEL FIAT TAP ADAPTABLE  
 PASSEND ZU FIAT-KRÄFTSTOFFHAHN  
 LLAVE CARBURANTE ADAPTABLE FIAT



Art./Ref.	Brand	Applicazione/Application	Rif. Orig./Orig. Ref.
03480	FIAT	1300, 311C, 312, 350, 355C, 411, 411C, 420, 450, 455C, 480, 500, 540, 550, 555c, 605C, 615, 640, 650, 655C	4970881, 4998702, 5109270, 551464, 576071, 591659
15461	NEW HOLLAND	TK160-55	4966618

**RACCORDO AD OCCHIELLO E VITE FORATA**

RACCORD BANJO ET VIS  
 EYED CONNECTION  
 AUGANSCHLUSS  
 RACOR EN OJO Y TORNILLO TALADRADO



Art./Ref.	Ø Occhio/Eyelet Ø	Ø Tubo/Hose Ø	Note/Notes
06740	12	6	Vite forata art. 01805 filetto M12x1,5/Driller screw ref. 01805 thread M12x1,5
06741	12	8	Vite forata art. 01805 filetto M12x1,5/Driller screw ref. 01805 thread M12x1,5
06742	12	10	Vite forata art. 01805 filetto M12x1,5/Driller screw ref. 01805 thread M12x1,5
06743	14	8	Vite forata art. 01831 filetto M14x1,5/Driller screw ref. 01831 thread M14x1,5
06744	14	10	Vite forata art. 01831 filetto M14x1,5/Driller screw ref. 01831 thread M14x1,5
06745	16	10	Vite forata art. 01814 filetto M16x1,5/Driller screw ref. 01814 thread M16x1,5

**TUBO SPECIALE IN GOMMA PER MISCELA**

TUYAU SPECIAL POUR MELANGE CARBURANT  
SPECIAL RUBBER HOSE FOR MIXTURE  
BESONDERER GUMMIROHR FÜR BENZIN  
TUBO ESPECIAL EN GOMA PARA MEZCLA

Art./Ref.	Diametro Tubo/Hose diam.	Note/Notes
<b>F07188</b>	Ø 3 x 6	Nero/Black
<b>00740</b>	Ø 4 x 7	Trasparente/Transparent
<b>00723</b>	Ø 5 x 9	Transparent/Transparent
<b>F07189</b>	Ø 5 X 9	Nero/Black
<b>00719</b>	Ø 7 X 12	Trasparente /Transparent

**TUBO IN GOMMA PER CARBURANTE**

TUBE EN CAOUTCHOUC POUR CARBURANT  
RUBBER HOSE FOR FUELS  
ROHR MIT GUMMI FÜR KRAFTSTOFF  
TUBO DE CAUCHO PARA CARBURANTE



**Note:** Tubo idoneo per adduzione di olii minerali, diesel e benzine ecologiche e compatibile con fluidi in accordo alle norme EN 590:2010. Utilizzabile a una temperatura da -20°C a +80°C. Struttura: A) Sottostrato liscio in gomma nera NBR resistente ai prodotti petroliferi con contenuto aromatico non superiore al 40%; B) Rinforzo con inserzioni di filati sintetici ad alta resistenza; C) Copertura in gomma nera nitrilica antistatica resistente all'abrasione, ai carburanti, agli olii e agli agenti atmosferici; D) Superficie liscia estrusa. Pressione esercizio: 10 bar; pressione scoppio 30 bar.

**Notes:** Hose suitable for loading of mineral oils, diesel and unleaded fuel, and compatible with fluids according to EN 590:2010. Temperature range: -20°C a +80°C. Construction: A) Tube black, smooth NBR rubber, petroleum products up to 40% aromatic content resistance; B) Reinforcement with high strength synthetic textile yarn; C) Cover black nitrilic antistatic rubber, abrasion, fuels, oils and weathering resistant; D) Surface smooth extruded. Working pressure 10 bar; burst pressure 30 bar.

Art./Ref.	Diametro Interno/ Inner diam.	Diametro Esterno/ Outer diam.	Pollici/Inches	Pressione d'esercizio BAR/ Working pressure BAR	Pressione scoppio BAR/ Burst pressure BAR
<b>89161</b>	5 mm	12 mm	3/16"	10 bar	30 bar
<b>02158</b>	6 mm	13 mm	1/4"		
<b>02159</b>	8 mm	15 mm	5/16"		
<b>02160</b>	10 mm	17 mm	3/8"		
<b>89162</b>	13 mm	20 mm	1/2"		
<b>89163</b>	15 mm	23 mm	19/32"		
<b>89164</b>	19 mm	27 mm	3/4"		
<b>89165</b>	25 mm	35 mm	1"		

**BOCCOLE IN ALLUMINIO PER TUBO TRECCIATO**

DOUILLES ALUMINIUM POUR TUBE TRESSE  
ALLUMINIUM BUSHES FOR BRAIDED HOSE  
ALUMINIUM BÜCHSEN FÜR ROHR MIT TEXTILFLECHTE  
CASQUILLO DE ALUMINIO PARA TUBO CON TRENZA

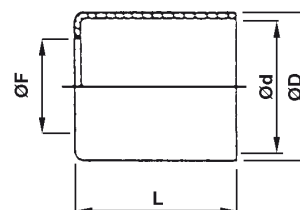

Art./Ref.	Diametro Interno/ Inner diam.	Diametro Esterno/ Outer diam.	Larghezza mm/ Width mm
<b>06688</b>	13	15	21
<b>06689</b>	15	17	23
<b>06690</b>	17.5	19	23

**COPERCHIO PER FILTRI CAV 296 796 CON ADESCATORE**

CAPOT POUR FILTRE CAV 296 ET 796 AVEC AMORCEUR  
 CAP FOR CAV 296 796 TYPE FILTERS WITH PRIMER  
 DECKEL FÜR CAV-FILTER 296 UND 796 MIT ANSAUGER  
 TAPA POR FILTROS CAV 296 796 CON CEBADOR



Art./Ref.	Note/Notes
<b>06966</b>	Coperchio per filtri Cav 296 e 796 con adescatore /Locking Device Cover for CAV filter 296 and 796

**SUPPORTO FILTRO FILETTO M 14 X 1,5**

SUPPORT FILTRE FILET M14X1,5  
 FILTER SUPPORT 14 X 1,5 THREAD  
 FILTERHALTER GEWINDE M14X1,5  
 SOPORTE FILTRO ROSCA M14X1,5



Art./Ref.	Note/Notes
<b>06967</b>	Senza adescatore/Without primer
<b>06968</b>	Senza adescatore/Without primer

**BICCHIERINO IN VETRO**

GOBELET EN VERRE  
 GLASS SUPPORT  
 GLASBECHER  
 VASO DE VIDRIO



Art./Ref.	Note/Notes
<b>07032</b>	Bicchierino in vetro/Glass support

**SUPPORTINO FILTRO COMPLETO PER POMPA ALIMENTAZIONE**

SUPPORT FILTRE COMPLET POUR POMPE ALIMENTATION  
 COMPLETE FILTER SUPPORT FOR FUEL PUMP  
 FILTERHALTER KOMPLETT FÜR PUMPE  
 SOPORTE FILTRO COMPLETO PARA BOMBA ALIMENTACIÓN



Art./Ref.	Note/Notes	Brand	Rif. Orig./Orig. Ref.
<b>07018</b>	Supporto filtro completo/ Complete filter support	<b>BOSCH</b>	1457434000
<b>07019</b>	Filtro per Pompa Alimentazione 07018 /Fuel pump filter for 07018	<b>FIAT</b>	705603, 772160, 9930048

**VASCA DECANATORE IN VETRO ADATTABILE A FIAT**

CUVE DECANTEUR EN VITRE ADAPTABLE FIAT  
 GLASS BOWL ADAPTABLE TO FIAT  
 KRAFTSTOFFSPEISUNGSBECKER AUS GLAS PASSEND ZU FIAT  
 CUBETA DE DECANTACION IN VIDRIO ADAPTABLE FIAT



Art./Ref.	Brand	Rif. Orig./Orig. Ref.
<b>02721</b>	<b>FIAT</b>	9918123
	<b>MASSEY FERGUSON</b>	1039071M1
	<b>PERKINS</b>	26560111, 26560601

**VALVOLA DI NON RITORNO**

CLAPET ANTI-RETOUR  
 ONE WAY VALVE  
 EINWEG-VENTILE  
 VALVULAS DE NO VUELTA



Art./Ref.	Diametro tubo mm/ Hose diameter mm	Note/Notes
<b>07098</b>	8	Valvola con filtro /Valve with filter
<b>07099</b>	10	Valvola con filtro /Valve with filter

**VALVOLE DI NON RITORNO**

CLAPET ANTI-RETOUR  
ONE WAY VALVES  
EINWEG-VENTILE  
VALVULAS DE NO VUELTA



Art./Ref.	Note/Notes
<b>07095</b>	Valvola non ritorno M 14 x 1,5 /14 x 1.5 M One way valve
<b>07096</b>	Valvola non ritorno M14x1,5 invertita/M14x1.5 Inverted one way valve

**VALVOLA DI SOVRAPRESSIONE ADATTABILE RIF. 1417413012 BOSCH**

CLAPET DE SURPRESSION ADAPTABLE RIF. 1417413012 BOSCH  
OVER PRESSURE VALVE ADAPTABLE TO RIF. 1417413012 BOSCH  
ÜBERDRUCKVENTILE PASSEND ZU RIF. 1417413012 BOSCH  
VALVULAS RESPIRADERAS PARA BOMBA SUMERGIDA ADAPTABLE RIF. 1417413012 BOSCH



Art./Ref.	Note/Notes	Brand	Rif. Orig./Orig. Ref.
<b>07088</b>	Valvola sovrappressione Ø 12/ Ø 12 Over-pressure valve	<b>BOSCH</b>	1417413012
<b>07087</b>	Valvola sovrappressione Ø 14/ Ø 14 Over-pressure valve	<b>FIAT</b>	758065

**VALVOLA DI NON RITORNO Ø 6 MM. - Ø 8 MM.**

CLAPET ANTI-RETOUR Ø 6 MM. - Ø 8 MM.  
ONE WAY VALVE Ø 6 MM. - Ø 8 MM.  
EINWEG-VENTIL Ø 6 MM. - Ø 8 MM.  
VALVULAS DE NO VUELTA Ø 6 MM. - Ø 8 MM.



Art./Ref.	Diametro tubo mm/ Hose diameter mm	Note/Notes
<b>07097</b>	Ø 6 - Ø 8	Valvola non ritorno Ø 6 mm. - Ø 8 mm. /Ø 6 mm. - Ø 8 mm One way valve

**VALVOLE DI SFIATO PER POMPA SOMMERSA**

CLAPET REFOULEMENT POUR POMPE SUBMERGÉ  
BREATHING VALVE FOR SUBMERGED PUMP  
ENTLUFTUNGSVENTIL FÜR TAUCHPUMPE  
VALVULAS RESPIRADERAS PARA BOMBA SUMERGIDA



Art./Ref.	Note/Notes	Filetto/Thread
<b>07092</b>	Valvola sfiato x pompa M6x1/Fuel pump bleed M6x1	M 6 X 1

**VALVOLE DI NON RITORNO**

CLAPET ANTI-RETOUR  
ONE WAY VALVES  
EINWEG-VENTILE  
VALVULAS DE NO VUELTA



Art./Ref.	Note/Notes	Diametro tubo mm/ Hose diameter mm
<b>07090</b>	Valvola non ritorno tipo "AC" /"AC"" One way valve	8
<b>07091</b>		10

**VITE DI SPURGO M6 ADATTABILE BOSCH**

VIS DE CURAGE M6 ADAPTABLE BOSCH  
M6 EXHAUST SCREW ADAPTABLE BOSCH  
ENTLUFTUNGSSCHRAUBE M6 PASSEND ZU BOSCH  
TORNILLO DE PURGA M6 ADAPTABLE BOSCH



Art./Ref.	Filetto/Thread	Note/Notes
<b>07007</b>	M6x1	Vite spurgo M6 adattabile Bosch/ M6 Bleed screw adaptable to Bosch



**VALVOLA PER POMPETTA ALIMENTAZIONE IN BACHELITE ROSSA LAPPATA**

CLAPET POUR POMPE ALIMENTATION EN BAKELITE ROUGE RODÉ  
 FUEL PUMP VALVE - IN RED LAPPED BAKELITE  
 VENTIL FÜR BRENNSTOFFPUMPE AUS ROTEM BAKELIT  
 VALVULA PARA BOMBA ALIMENTACIÓN IN BAQUELITA ROJA ALISADA



Art./Ref.	Note/Notes	Brand	Rif. Orig./Orig. Ref.
07089	Valvola per pompa alimentazione / Feed pump valve	BOSCH	2443123021

**TAPPI DI SPURGO**

BOUCHONS DE PURGE  
 BLOWDOWN SCREWS  
 ENTLUFTUNGSSCHRAUBEN  
 TAPAS DE PURGA



Art./Ref.	Note/Notes	Filetto/Thread
07003	Tappo spurgo M 12x1,5/M12x1,5 Drain plug	M 12X1,5
06969	Tappo spurgo Cav 1/2" UNF/Drain plug Cav 1/2" UNF	1/2" UNF

**SPURGO CORTO REGOLATORE ADATTABILE CAV**

CURAGE COURT REGOLATEUR ADAPTABLE POUR CAV  
 ADJUSTER SHORT BLOWDOWN SCREW ADAPTABLE TO CAV  
 ENTLUFTUNGSSCHRAUBE KURZ REGULIERBAR PASSEND ZU CAV  
 PURGA CORTA REGULADORA ADAPTABLE CAV



Art./Ref.	Note/Notes	Brand	Rif. Orig./Orig. Ref.
07005	Spurgo corto regolatore /Adjuster short blowdown screw	CAV	7123-351B

**SPURGO LUNGO CORPO POMPA ROTATIVA ADATTABILE CAV**

CURAGE LONG CORP POMPE ROTATIVE ADAPTABLE CAV  
 ROTATION ADAPTABLE CAV PUMP LONG EXHAUST SCREW  
 ENTLUFTUNGSSCHRAUBE LANG FUR ROTATIONSPUMPE PASSEND ZU CAV  
 PURGA LARGA CUERPO BOMBA ROTATIVA ADAPTABLE CAV



Art./Ref.	Brand	Rif. Orig./Orig. Ref.
07004	CAV	7123-352B

**BULLONI FORATI PER INIETTORI**

BOULONS PERCÉS POUR INJECTEUR  
 DRILLED SCREWS FOR INJECTORS  
 SCHRAUBEN GEBOHRT FÜR INJEKTIONSGERÄTE  
 PERNO HORADOS PARA INYECTORES



Art./Ref.	Filetto/Thread	Note/Notes
07001	M8x1	Bullone forato M8x1/M8x1 Bleed Screw
07000	M8x1,25	Bullone forato M8x1,25 /M8x1,25 Perforated bleed screw

**RACCORDI ENTRATA NAFTA**

RACCORDS ENTRÉ NAFTA  
 FUEL INLET FITTINGS  
 BRENNSTOFFEINLASS-Verschraubungen  
 RACORES ENTRADA NAFTA



Art./Ref.	Note/Notes
06974	Raccordo entrata 12 -14 /12 -14 Inlet fitting

**RACCORDI PORTAGOMMA**

RACCORDS PORTE TUYAU  
FITTINGS  
VENTIL VERSCHRAUBUNGEN  
RACORES LLEVAGOMA



Art./Ref.	Filetto/Thread	Diametro tubo mm/Hose diameter mm
<b>07039</b>	Raccordo M 12 x 1,5	8

**RACCORDO FILTRO ADATTABILE CAV**

RACCORD FILTRE ADAPTABLE CAV  
ADAPTABLE CAV FILTER FITTING  
PASSEND ZU CAV FILTER VERSCHRAUBUNG  
RACORES FILTRO ADAPTABLE CAV



Art./Ref.	Note/Notes
<b>06970</b>	Raccordo filtro Cav/Cav Filter fitting

**RACCORDI AD OCCHIELLO A DUE VIE**

RACCORDS 2 VOIES  
2 WAY-EYE FITTINGS  
2WEGE-VERSCHRAUBUNG  
RACORES A OJAL A 2 VIAS



Art./Ref.	Ø Occhiello/ Eyelet Ø.	Ø tubo mm/ Hose Ø mm	Note/Notes
<b>07033</b>	6	4	Raccordo occhiello a due vie Ø6 / 2-way Ø 6 eye fitting

**ADESCATORE CORTO ADATTABILE BCD CORONA**

AMORCEUR COURT ADAPTABLE BCD CORONA  
SHORT PRIMER ADAPTABLE TO BCD CORONA  
ANSAUGER KURZ PASSEND BCD CORONA  
ASPIRADOR CORTO ADAPTABLE BCD CORONA



Art./Ref.	Filettatura/Thread	Brand	Applicazione/Application	Rif. Orig./Orig. Ref.
<b>14946</b>	M 16 x 1,5	<b>BCD CORONA</b>	-	9411
		<b>BOSCH</b>	-	2447222000/016
		<b>FIAT</b>	120C, 140.90DT, 160.90DT, 180.90DT, 70C	746189, 772102, 774417, 79020913, 79032352, 79047878, 9968879, 9970182
		<b>LAVERDA</b>	L627	9968879
		<b>NEW HOLLAND</b>	9630, 9640, 9645, FX28, FX300, FX375, FX450, TF78, TX68	9968879

**ADESCATORE LUNGO ADATTABILE BOSCH**

AMORCEUR LONG ADAPTABLE POUR BOSCH  
LONG PRIMER ADAPTABLE TO BOSCH  
ANSAUGER LONG PASSEND ZU BOSCH  
ASPIRADOR LARGO ADAPTABLE BOSCH



Art./Ref.	Filetto/Thread	Note/Notes	Brand	Rif. Orig./Orig. Ref.
<b>16668</b>	M 16x1,5	ADESCATORE IN ALLUMINIO/PRIMER ALUMINUM TYPE	<b>BOSCH</b>	2447222001

**ADESCATORE MAGGIORATO M16X1,5 ADATTABILE BCD CORONA**

AMORCEUR MAJORE' M16X1,5 ADAPTABLE BCD CORONA  
OVERSIZED PRIMER M16X1,5 ADAPTABLE TO BCD CORONA  
ANSAUGER LANG M16X1,5 PASSEND ZU BCD CORONA  
ASPIRADOR M16X1,5 ADAPTABLE BCD CORONA



Art./Ref.	Filetto/Thread	Note/Notes	Brand	Rif. Orig./Orig. Ref.
<b>18225</b>	M 16x1,5	Foro Ø 25 tipo universale /Ø 25 Universal Hole	<b>BCD CORONA</b>	D9350 54221001
			<b>FIAT</b>	771388

**CARBURATORI ORIGINALI DELL'ORTO ADATTABILI A ACME**

CARBURATEURS ORIGINE DELL'ORTO ADAPTABLE ACME  
 ORIGINAL DELL'ORTO CARBURATORS ADAPTABLE TO ACME  
 DELL'ORTO ORIGINALVERGASER PASSEND ZU ACME  
 CARBURADORES ORIGINALES DELL'ORTO ADAPTABLE ACME



Art./Ref.	Note/Notes	Brand	Applicazione/Application	Rif. Orig./Orig. Ref.
05959	N° regolazione 7449/Adjustment n. 7449	ACME	MOTORE/ENGINE A220 B	155138
05962	N° regolazione 1719/Adjustment n. 1719	CM MOTORI	MOTORE-ENGINE CM 46	
05963	N° regolazione 1732/Adjustment n. 1732		MOT STAZ-STATIONARY CM80-CM90	
05964	N° regolazione 7378/Adjustment n. 7378	COTIEMME	MOT-ENGINE CA180L/B-CA148P/LP	
05959	N° regolazione 7449/Adjustment n. 7449	DELL'ORTO	-	FHC 20.16 A
05962	N° regolazione 1719/Adjustment n. 1719		-	SHA 14.12 L
05963	N° regolazione 1732/Adjustment n. 1732		-	SHA 14.14 L
05964	N° regolazione 7378/Adjustment n. 7378		-	FHCD 20.16
05968	N° regolazione 7376/Adjustment n. 7376		-	FHCD 20.16A
05969	N° regolazione 7396/Adjustment n. 7396		-	FHCD 20.16A
05971	N° regolazione 7358/Adjustment n. 7358		-	FHCD 20.16
05968	N° regolazione 7376/Adjustment n. 7376	MINARELLI	MOTORE-ENGINE I90 - I125	15.7008.9
05969	N° regolazione 7396/Adjustment n. 7396		MOTORE-ENGINE I90/3 MOTOZAPPA	
05971	N° regolazione 7358/Adjustment n. 7358	MORINI	MOTORE AGRIC/ENGINE C100 -CZ7	

**CARBURATORI ORIGINALI BING ADATTABILE MOTORI JLO**

CARBURATEURS ORIGINE BING ADAPTABLE POUR MOTEUR JLO  
 ORIGINAL BING CARBURATORS ADAPTABLE TO JLO ENGINES  
 BING-ORIGINALVERGASER PASSEND ZU JLO MOTOREN  
 CARBURADORES ORIGINALES BING ADAPTABLE PARA MOTORES JLO BING PARA MOTORES JLO



Art./Ref.	Brand	Applicazione/Application
05949	JLO	L152
05950		L197

**INIETTORI ADATTABILI CASE**

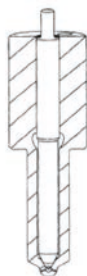
 INJECTEURS ADAPTABLE CASE  
 INJECTORS ADAPTABLE TO CASE  
 EINSPRITZDÜSE PASSEND ZU CASE  
 INYECTORES ADAPTABLE CASE

Art./Ref.	Brand	Applicazione/Application	Rif. Orig./Orig. Ref.
<b>88102</b>	<b>CASE</b>	1270,1370, MOT.504BDT,415BDT	4760843, 772019
<b>35026</b>	<b>FIAT</b>	100-55,100-90,110-90DT,110-90, 100-90DT,45-66,45-66DT,45-66S, 45-66S DT,45-76V,50-66,50-66DT, 50-66S,50-66S DT,50-86V, 50-86V DT,50-86S V,50-86S V DT, 55-46,55-46DT,55-56,55-56DT, 55-65F,55-65M,55-65V,55-66, 55-66DT,55-66DT LP,55-66F, 55-66F DT,55-66LP,55-66V,, 55-66V DT,55-66S,55-66S DT, 55-75F,55-75M,55-75V,55-76F, 55-76F DT,55-76V,55-76V DT, 55-85F,55-85M,55-85V,55-88, 55-88DT,56-66S,56-66S DT, 60-46,60-46DT,60-56DT,65-46, 65-46DT,65-56,65-56DT,65-66, 65-66DT,65-66S,65-66S DT, 65-88,65-88DT,65-90,65-90DT, 65-93,65-93DT,65-94,65-94DT, 70-56,70-56DT,70-65,70-65M, 70-66,70-66DT,70-66F,70-66F DT, 70-66LP,70-66LP DT,70-66V, 70-66S DT HC,70-75,70-75M, 70-66S,70-66S HC,70-66S DT, 70-76F,70-76F DT,70-76LP, 70-76LP DT,70-76V,70-86V, 70-86V DT,70-86S V,70-86S V DT, 70-88,70-88DT,70-90,70-90DT, 72-85,72-85M,72-86F,72-86F DT, 72-86LP,72-86LP DT,72-93,, 72-93DT,72-94,72-94DT	4791689, 4792443
<b>35616</b>		55.86F-55.86F DT, 55.86S V-55.86S V DT, 55.86V-55.86V DT, 60-56 (1/89->.....), 60-65 (9/84->12/88), 60-65M(9/84->12/88), 60-65V(9/84->12/88), 60-66 (6/84->12/92), 60-66DT(6/84->12/92), 60-66F (1/84->12/90), 60-66FDT(6/84->12/92), 60-66LP(1/84->12/90), 60-66LPDT(1/84->12/90), 60-66S(12/92->.....), 60-66SDT(12/92->...), 60-75 (1/89->12/92), 60-75M(1/89->12/92), 60-75V(1/89->12/92), 60-88 (4/90->12/92), 60-88DT(4/90->12/92), 60-90 (1/84->12/90), 60-90DT(1/84->12/90), 60-93 (1/93->12/95), 60-93DT(1/93->12/95), 60-94 (1/93->12/95), 60-94DT(1/93->12/95), 60.76F-60.76F DT, 60.86 F-60.86F DT, 60.86 V-60.86 V DT, 60.88-60.88 DT, 62.86 F-62.86F DT, 80-65 (9/84->12/88), 80-66 (6/84->12/92), 80-66DT(6/84->12/92), 80-75 (1/89->12/92), 80-88 (4/90->12/92), 80-88DT(4/90->12/92), 80-90 (1/84->12/92), 80-90DT(1/84->12/92), 82-85 (9/92->.....), 82-86 (3/92->.....), 82-86FDT(3/92->.....), 82-86LP(3/92->.....), 82-86LPDT(3/92->.....), 82-93 (1/93->12/95), 82-93DT(1/93->12/95), 82-94DT(1/93->12/95), 85-55 (9/84->12/88), 88-85 (9/92->.....), 88-93 (1/93->12/95), 88-93DT(1/93->12/95), 88-94 (1/93->12/95), 88-94DT(1/93->12/95), F110-F110 DT, F120-F120 DT	4817267, 4824171, 99431240
<b>42950</b>		F100-F100 DT, F130-F130 DT, F140-F140 DT	98419045, 98435369, 98471321
<b>88101</b>		100,1000S,1000DT,1000 SUPER, 1000 SUPER, 1180,1180DT,1280, 1280DT,1300,1300DT,1300S,, 1300SDT,1355C,1380,1380DT, 1580,1580DT,1880,1880DT, 200R,211R,215C,221,250,250DT, 255,300,300DT,300J,311,311R, 312,312R,315,321,331,332,350, 350DT,351,352C,355,366,400, 400DT,411,411R,412,412R,415, 415DT,420,420DT,421,431,440, 440DT,441,446,446DT,450,450DT, 451,455C,460,460DT,465,466, 466DT,470,470DT,474,474DT,480, 480DT,500,500DT,505C,540,540DT, 540S,550,565C,566,570,580,600, 605C,640,655C,666,670,680,766, 780,855C,880-5,900,980,995C, 8365.05, MOT.605D,8045.02,OM CO 3/80, MOT.8035.01,8065.01,OM CO 2D, MOT.8035.02D,8065.24, MOT.8035.04,8365.25,OM CO 3/70, MOT.8045.01,OM CP 3/100, MOT.8065.04,OM CN 3,8025.02, MOT.OM CO 1D/45,8055.04, MOT.OM CO 3/60, MOT.OM CO 3/75,615D,8065.02, MOT.OM CO 3D/130,8045.04, OM CO 1D,OM CP 3,8035.02	4758260, 767404, 770945, 9967223
<b>88102</b>		1000 SUPER,1000DT,1000N,1000S, 1180,1180DT,1280,1280DT,1380, 1380DT,466,466DT,480,480DT, 540DT,540S,566,570,580,605C, 640,666,670,680,766,780,880-5, 980, MOT.8035.02,8055.04,8045.02, MOT.8065.04,8035.02D,8045.04, MOT.8065.24,8035.04,8065.02	4760843, 772019
<b>35026</b>	<b>FORD</b>	3435,3935,4135,4230,4635,4835, 5635,6635,7635,	4792443, 99474914
<b>35616</b>		3830 (8035.06), 3830 - 4030, 4010S, 4030 (8035.05), 4430 (8045.05), 4635 (9/95->12/98), 4835 (9/95->12/98), 5635 (9/95->12/98), 6635 (8045.05), 7635 (9/95->12/98)	4817267, 99431240
<b>41861</b>		3000, 3055, 3100, 3120, 3150, 3300, 7100, 7200, 8700, 9700, TW10 - 20 - 30	81821327, C9NN9E527B
<b>41862</b>		231, 233, 2600, 2600N, 2600R, 2600V, 333, 335, 3600, 3600N, 3600NO, 3600R, 3600V, 3900, 420, 4600, 4600NO, 4600O, 4600SU, 515, 531, 532, 535, 5600, 5700, 6600, 6600C, 6600O, 6700, 7600, 7600C, 7700	83900064, D4NN9E527C
<b>41864</b>		231, 233, 2600, 2600N, 2600R, 2600V, 333, 335, 3600, 3600N, 3600NO, 3600R, 3600V, 3900, 420, 4600, 4600NO, 4600O, 4600SU, 5110, 515, 531, 532, 535, 5600, 5610, 5700, 6410, 6600, 6600C, 6600O, 6610, 6610O, 6700, 6710, 6810, 7410, 7600, 7600C, 7610, 7610O, 7700, 7710, 7810, 7810O, 7910, 8210, 8530, 8630-8730-8830, TW5 - 15 - 25 - 35	83919155, D9NN9E527AA
<b>42950</b>		4635-4835-5635-6635-7635	98435369
<b>88101</b>		DEXTA,MAJOR,POWER MAJOR, MOTORE 220, SUPER DEXTA,SUPER MAJOR	767404, 770945
<b>42950</b>	<b>IVECO</b>	8045.25K,8065.25, 8065.05,8065.25S,8065.06	98435369
<b>88101</b>			4758260, 9967223

Art./Ref.	Brand	Applicazione/Application	Rif. Orig./Orig. Ref.
40476	LANDINI	4000 SPECIAL,5000DT,6000, 4530V, 4560V, 5500, 5530F, 5530L, 5530V, 5560F, 5560L, 5560V, 5830, 5840, 5860, 5870, 6860, 6880, 7860, 7880, 8860, 8880, 9060, 9080, 9880, ADVANTAGE 55F, ADVANTAGE 55FP, ADVANTAGE 55GE, ADVANTAGE 55GT, ADVANTAGE 55GTP, ADVANTAGE 55L, ADVANTAGE 55LP, ADVANTAGE 65F, ADVANTAGE 65FP, ADVANTAGE 65GE, ADVANTAGE 65GT, ADVANTAGE 65GTP, ADVANTAGE 65L, ADVANTAGE 65LP, ADVANTAGE 75F,75FP,75GE,75GT, ADVANTAGE 85F,85FP,85GT,85GTP, ADVANTAGE 85L,85LP,85GT, ATLANTIS 100,75,80,90, ATLAS 100,75,80,90, BLIZZARD 50,65,75,85,95, C4500,C4830,C5500,C5830, CF4830,CF5030,CF5830, GHIBLI 100,105,85,95, GLOBALFARM 100,105,90,95, GLOBUS 50,55, LANDPOWER 115,125,130,145,160, LANDPOWER 165,185, LEGEND 105,115,130,145,165, LEGEND 115NG,120NG,130NG,140NG, LEGEND 125NG TDI,130 BLU, LEGEND 135NG TDI,145NG TDI, LEGEND 160 BLU,165NG TDI, LEGEND 160NG,180NG, LEGEND 185NG TDI, MYTHOS 105,115, MYTHOS 90,100, POWERFARM 75,85,95,105, REX 90GE, TREKKER 100C,70C,70F,70L,80C, TREKKER 105C,105F,105M,85C, TREKKER 50F,55F, TREKKER 80F,80L,90C,90F,90L, TREKKER 85F,85M,95C,95F,95M, TREKKER C75,C85,C95, TREKKER CF55,CF65,CF85, VIGNETO 55V,60V,65V,75V, VIGNETO 75V,85V, VISION 80,90,100, VISION 85,95,105	1447252M1
40477		3000R,3000RV,4000SPECIAL, 5000DT,5000R,5000R,5000R-N, 5000R-S,5000SPECIAL,6000, 6000DT,6000 SPECIAL,7000R, C5000,C6000	1853019M91
40479		4560V,5560F/L,5860, 5500,6500, 5530F/L/V,5830, 5840, 5870, ADVANTAGE 55F/FP/GE/GT/GTP/L, BLIZZARD 50, C5500,C5830,CF5030,CF5830, GLOBUS 50, TREKKER CF55,55F, VIGNETI 55V	1446896M1
40480		6060,6060F,6060L,6060V, 6070, ADVANTAGE 60F,60FP,60GE,60GT, ADVANTAGE 60GTP,60L,60LP, BLIZZARD 60, CF6030,CF6060, TREKKER CF60, VIGNETO 60V	3637320M1
40484		8860, 9060, 9080, 9880, ADVANTAGE CAB:L95GT, ADVANTAGE L95GT, ATLANTIS 85, ATLAS:85, BLIZZARD:95, SERIE 60NEW:8860(MOTORE BLU), TREKKER:C95	3637319M1
40485		8530F/L,8500,8560F/L,8860, 8550, 8830, 8870,8880, ADVANTAGE 85F/FP/GE/GT/GTP/L/V, BLIZZARD 85, C7800,C7830,C8860, TREKKER C85,CF85,85F	1446703M1
40489		9500, C10500, LARGE 10000,10000S	883258M91
40493		LARGE 16000,16500,9550	1447658M1
35026	LAVERDA	3400,3400R	4792443
40476	MASSEY FERGUSON	-	1447252M1
40477		135 (->203993D), 135V(->203993D), 765, IND.3165,3303,3305,356,50	1853019M91
40479		145,148,152,154,233,244,250, 253,254,255,2205,342,350,353, 354,3210,550, INDUST.20C,20D,20E,30B,30E,40	1446896M1, 3639738M1, 4222905M1
40480		352,355,360, 363,363LX,363S, 364AP,364AQ,364CF,364F,364FP, 40E INDUSTRIAL	3637320M1
40484		1004T,1007,390T,393TLX,394TAQ, 3070,4225(->01/01/99), 396CT,397T,398,3065,3065S, 4225HV(->01/01/99), 4235 (->01/01/99), 4235HV(->01/01/99), 698T,6110, INDUSTRIAL 60HX,60HX-T	3637319M1
40485		178,185,188,194,194C,194F,194S, 285,293,294,294C,294S, IND.50EX,50HX,50HX-S,60H,60H-S	1446703M1
40489			883258M91
40493		2720,2725, 3650, AT6.354.4	1447658M1
35026	NEW HOLLAND	L60,L65,L75,L85,L95,, TL70,TL80,TL90,TL100	4792443, 99474914
35616		L60, L65, L75, L85, L95, TL100, TL70, TL80, TL90	4817267, 4824171, 99431240
42950		L60-65-75-85-95, TL65-70-80-90-100	98435369, 98471321
40476	PERKINS	1004.40T, 1004.42, 1006.6, 1006.60T, 1006.6T, 1104C-44, 1104C-44T, 1106C-E60TA, 903-27, A3.144, A3.152, A4.203, A4.236, A4.248, A4.41, AD3.152, AD4.203, AT4.236	26460257, 2646607, 31990, 35504
40479		AD3 152,A4 236	2646825, 2646C620
40477		AD3.152,AD4.203	26461311, 2646673, 2646676
40480		AD3.152, AT3.152.4, AT3.152	2645K603, 26461307
40484		AT4.236,A4.41,1004.42	2645C617, 2645K602
40485		A4.248,A4.236	2645C611, 2646678, 2646690
40489		A6.354, A6.354.1, A6.354.4, AD3.152	883258M91
40492		AT6.354.1	2646698
40493		AT6.354.4,A6.354.4	2645A603
PK2645A617		ORIGINALE	
88102	UNIVERSAL	1010,340,530,533,640,643,703	4760843, 772019

# 1.7.22 Climatizzazione

Air conditioning



## Ricambi & accessori per macchine agricole

SPARE PARTS & ACCESSORIES FOR AGRICULTURAL MACHINE

Tutti gli articoli della presente sezione, prodotti da AMA SPA e/o da terzi per conto di AMA, sono adattabili ("non originali") alle marche indicate ai sensi di quanto previsto dal REG. CE n. 1400/2002. I diritti sui marchi citati appartengono ai legittimi proprietari ed il loro uso ha l'esclusiva finalità di consentire all'utilizzatore la comparazione dei diversi prodotti. All items of this section, manufactured by AMA SPA and/or any third party on behalf of AMA, are adaptable ("non-original") to the brands listed under the provisions of the REG. CE n. 1400/2002. The rights on the trademarks belong to their respective owners and their usage is only aimed to allow the user to compare different products.









**COMPRESSORE ARIA CONDIZIONATA ADATTABILE**

COMPRESSEUR DE CLIMATISATION ADAPTABLE

AIR CONDITIONING COMPRESSOR ADAPTABLE











KLIMAKOMPRESSOR PASSEND ZU

COMPRESOR DE AIRE ACONDICIONADO ADAPTABLE







Art./Ref.	Note/Notes	Brand	Applicazione/Application	Rif. Orig./Orig. Ref.	Immagine/Image
<b>71632</b>	Compressore aria condizionata adattabile rif. Sanden SD8147/Air conditioning compressor adaptable ref. Sanden SD8147/	<b>AGCO</b>	DT180A-DT200A, DT220A-DT240A, LT75A-LT90A, LT85A, LT95A, RT140A-RT155A, RT165A	-	
<b>71605</b>	Compressore aria condizionata adattabile rif. Sanden SD8230,SD7890,SD8028/Air conditioning compressor adaptable ref. Sanden SD8230,SD7890,SD8028	<b>CASE</b>	MAXXUM 120 - 130 - 140 - 155, MAXXUM 175 - 190	82002069	
<b>71622</b>	Compressore aria condizionata adattabile rif. YORK ER210R/Air conditioning compressor adaptable ref. YORK ER210R		AXIAL FLOW 1440-1460	118250C91	
<b>71625</b>	Compressore aria condizionata adattabile rif. Sanden SD4609/Air conditioning compressor adaptable ref. Sanden SD4609		BI-DIRECTIONAL TVI145, T9000 4WD, T9010, T9020, TJ 275, TJ 280, TJ 325, TJ 330, TVT 135, TVT 155, TVT 170, TVT 190, TVT 195	1999755C3	
<b>71630</b>	Compressore aria condizionata adattabile rif. Sanden SD7862,SD8023/Air conditioning compressor adaptable ref. Sanden SD7862,SD8023		COMBINE 521-525-527	60506146	
<b>71632</b>	Compressore aria condizionata adattabile rif. Sanden SD8147/Air conditioning compressor adaptable ref. Sanden SD8147	<b>CHALLENGER</b>	MT425B, MT445B, MT455B, MT465B, MT555B-MT565B, MT575B, MT635B-MT645B, MT655B-MT665B		
<b>71612</b>	Compressore aria condizionata adattabile rif. Denso 10PA15C447170-8930/Air conditioning compressor adaptable ref. Denso 10PA15C447170-8930	<b>CLAAS</b>	CELTICS 456 RC		
<b>71620</b>	Compressore aria condizionata adattabile rif. Sanden SD6651/Air conditioning compressor adaptable ref. Sanden SD6651		MIETITREBBIE DOMINATOR, MIETITREBBIE MEDION, MIETITREBBIE MEGA	625.879.0	

Art./Ref.	Note/Notes	Brand	Applicazione/Application	Rif. Orig./Orig. Ref.	Immagine/Image
71622	Compressore aria condizionata adattabile rif. YORK ER210R/Air conditioning compressor adaptable ref. YORK ER210R	CLAAS	DOMINATOR, JAGUAR 685-690-695, MEGA	402466, 621.029.0	
71630	Compressore aria condizionata adattabile rif. Sanden SD7862,SD8023/Air conditioning compressor adaptable ref. Sanden SD7862,SD8023		CELTICS 426-436-446		
71631	Compressore aria condizionata adattabile rif. Sanden SD8088,SD7952/Air conditioning compressor adaptable ref. Sanden SD8088, SD7952		RANGER TELES 928-925, RANGER TELES 975-964	315.792.0	
71606	Compressore aria condizionata adattabile rif. Sanden SD8091/Air conditioning compressor adaptable ref. Sanden SD8091	DEUTZ	AGROFARM - AGROFARM COM 3, AGROTRON, AGROTRON 4, AGROTRON 6, AGROTRON K - AGROTRON K COM 3, AGROTRON MK3, AGROTRON NEW, AGROTRON PROFILINE, AGROTRON TTV	04437338	
71630	Compressore aria condizionata adattabile rif. Sanden SD7862,SD8023/Air conditioning compressor adaptable ref. Sanden SD7862,SD8023		AGROTRON 230-260	4437339	
71610	Compressore aria condizionata adattabile rif. Denso 10PA15C447100-5050/Air conditioning compressor adaptable ref. Denso 10PA15C447100-5050	FENDT	FARMER 200-300-400, FAVORIT 500-700-800-900, GT370-380-390-395, XILON 520-522-524	G311550020100	
71605	Compressore aria condizionata adattabile rif. Sanden SD8230,SD7890,SD8028/Air conditioning compressor adaptable ref. Sanden SD8230,SD7890,SD8028	FIAT	SERIE 60	82002069	
84677	Compressore aria condizionata adattabile rif. Sanden SD7929, SD8223/Air conditioning compressor adaptable ref. Sanden SD7929, SD8223		140-90 DT, 50-86S V, 55-86 F, 55-86F DT, 55-86S V, 55-86S V DT, 60-86 F DT, 60-86F, 60-86S V, 60-86S V DT, 65-94, 65-94 DT, 70-86S V, 70-86S V DT, 72-94, 72-94 DT, 82-94, 82-94 DT, 88-94, 88-94 DT	5165549	
71605	Compressore aria condizionata adattabile rif. Sanden SD8230,SD7890,SD8028/Air conditioning compressor adaptable ref. Sanden SD8230,SD7890,SD8028	FORD	8160, 8260, 8360, 8560	82002069	

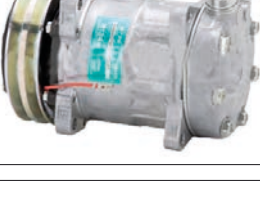

Art./Ref.	Note/Notes	Brand	Applicazione/Application	Rif. Orig./Orig. Ref.	Immagine/Image
<b>71623</b>	Compressore aria condizionata adattabile rif. Sanden SD8100/Air conditioning compressor adaptable ref. Sanden SD8100	<b>FORD</b>	8160-8260-8360-8560	82016158	
<b>84677</b>	Compressore aria condizionata adattabile rif. Sanden SD7929, SD8223/Air conditioning compressor adaptable ref. Sanden SD7929, SD8223		4635, 4835, 5635, 6635, 7635, 8430	5165549	
<b>71608</b>		<b>JCB</b>		123/04998, 997/04600	
<b>71611</b>	Compressore aria condizionata adattabile rif. Denso 10PA15C447100-2990/Air conditioning compressor adaptable ref. Denso 10PA15C447100-2990	<b>JOHN DEERE</b>	MIETITREBBIA	AZ44541	
<b>71612</b>	Compressore aria condizionata adattabile rif. Denso 10PA15C447170-8930/Air conditioning compressor adaptable ref. Denso 10PA15C447170-8930		TRATTORE SERIE 6000	AL155836, AL78779	
<b>71602</b>	Compressore aria condizionata adattabile rif. Sanden SD7170/Air conditioning compressor adaptable ref. Sanden SD7170	<b>LAMBORGHINI</b>	880F-PLUS, 990F-PLUS	0.007.7197.4	
<b>71630</b>	Compressore aria condizionata adattabile rif. Sanden SD7862, SD8023/Air conditioning compressor adaptable ref. Sanden SD7862, SD8023		CHAMPION 180		
<b>71601</b>	Compressore aria condizionata adattabile rif. Sanden SD7851/Air conditioning compressor adaptable ref. Sanden SD7851	<b>LANDINI</b>	ADVANTAGE 4 CYL, ADVANTAGE VIGNETI, BLIZZARD	3550921M91	
<b>71613</b>	Compressore aria condizionata adattabile rif. Delpy-Harrison 085015120/1A/Air conditioning compressor adaptable ref. Delpy-Harrison 085015120/1A		LANDPOWER, LEGEND 105, MYTHOS 115, SERIE 80, VISION 85-95-105	3552611M91	
<b>71614</b>	Compressore aria condizionata adattabile rif. Sanden SD9149/Air conditioning compressor adaptable ref. Sanden SD9149		10000, 12500, 13000, 14500, 16000, 16500, 16550, 17500, 19000, 19500	3386861M1	

Art./Ref.	Note/Notes	Brand	Applicazione/Application	Rif. Orig./Orig. Ref.	Immagine/Image
71604	Compressore aria condizionata adattabile rif. Sanden SD6631/Air conditioning compressor adaptable ref. Sanden SD6631	LAVERDA	1950 LX MIETITREBBIATRICE, 1950 MCS MIETITREBBIATRICE, 2050 MCS MIETITREBBIATRICE, 2560 MCS MIETITREBBIATRICE, 2760 LS MIETITREBBIATRICE, 2760 MCS MIETITREBBIATRICE, L 518-L 520 MIETITREBBIATRICE, L517 MIETITREBBIATRICE, L624 MIETITREBBIATRICE, L625 MIETITREBBIATRICE, L626 MIETITREBBIATRICE, L627 MIETITREBBIATRICE	322333200	
71601	Compressore aria condizionata adattabile rif. Sanden SD7851/Air conditioning compressor adaptable ref. Sanden SD7851	MASSEY FERGUSON	373, 374, 383, 384, 393, 394	3550921M91	
71602	Compressore aria condizionata adattabile rif. Sanden SD7170/Air conditioning compressor adaptable ref. Sanden SD7170		VSF 3000		
71614	Compressore aria condizionata adattabile rif. Sanden SD9149/Air conditioning compressor adaptable ref. Sanden SD9149		1014, 1024, 1035, 1134, SERIE 2000, SERIE 3000, SERIE 3600	3386861M1	
71622	Compressore aria condizionata adattabile rif. YORK ER210R/Air conditioning compressor adaptable ref. YORK ER210R		MIETITREBBIE SERIE 27-29-31, MIETITREBBIE SERIE 6-8	D45054800	
71631	Compressore aria condizionata adattabile rif. Sanden SD8088,SD7952/Air conditioning compressor adaptable ref. Sanden SD8088, SD7952		3060-3065-3075-3085-3095, 3120-3125, 3635-3645-3655-3670-3690, 4225-4235-4240, 4245-4255-4265, 4260-4270, 4325-4335, 4345-4355, 4360-4370, 5335-5340-5355-5360-5365, 5425-5435-5445-5455, 5470, 5470SA-5475SA, 6120-6130-6140-6150, 6160-6170-6180-6190, 6235-6245-6255, 6260-6265-6270-6280-6290, 660-680, 8110-8120-8130-8140, 8150-8160-8170-8180, 8210-8220-8240-8250, 8260-8270-8280	3712528M2, 3782613M2	
71632	Compressore aria condizionata adattabile rif. Sanden SD8147/Air conditioning compressor adaptable ref. Sanden SD8147	DT180A-DT200A, DT220A-DT240A, LT75A-LT90A, LT85A, LT95A, MF5425, MF5435, MF5445, MF5455, MF5460, MF5460/5460SA, MF5470, MF5480, MF6445, MF6445/6455, MF6455, MF6460, MF6460/6470, MF6465/6475/6480, MF6470, MF6485/6490, MF6495, MF6497, MF6497/6499, MF6499, MF7465/7475/7480, MF7485/7490, MF7495, MF8450/8460, MF8470/8480, RT140A/RT155A, RT165A	3789035M1, 4789035M1		

Art./Ref.	Note/Notes	Brand	Applicazione/Application	Rif. Orig./Orig. Ref.	Immagine/Image
<b>71605</b>	Compressore aria condizionata adattabile rif. Sanden SD8230,SD7890,SD8028/Air conditioning compressor adaptable ref. Sanden SD8230,SD7890,SD8028	<b>NEW HOLLAND</b>	M100, M115, M135, M160	82002069	
<b>71623</b>	Compressore aria condizionata adattabile rif. Sanden SD8100/Air conditioning compressor adaptable ref. Sanden SD8100		M100-M115-M135-M160, TM115-120-125-130-135-140, TM150-155-165-175-180-190, TV140	82016158	
<b>71630</b>	Compressore aria condizionata adattabile rif. Sanden SD7862,SD8023/Air conditioning compressor adaptable ref. Sanden SD7862,SD8023		FORAGER, FX300-375-450, TC56 COMBINE, TX62-64-65-68 COMBINE	84018078, 89831429	
<b>71642</b>	Compressore aria condizionata adattabile rif. Sanden SD6332/Air conditioning compressor adaptable ref. Sanden SD6332		TN55D, TN55S, TN55V, TN60DA, TN60SA, TN60VA, TN65D, TN65F, TN65N, TN65S, TN65V, TN70D, TN70DA, TN70F, TN70NA, TN70S, TN70SA, TN70VA, TN75D, TN75DA, TN75F, TN75FA, TN75N, TN75NA, TN75S, TN75SA, TN75V, TN75VA, TN80F, TN85FA, TN90F, TN95F, TN95FA, TN95NA, TN95VA	5176185	
<b>84677</b>	Compressore aria condizionata adattabile rif. Sanden SD7929, SD8223/Air conditioning compressor adaptable ref. Sanden SD7929, SD8223		L60, L65, L75, L85, L95, TD55D, TD60D, TD65D, TD70D, TD75D, TD80D, TD85D, TD90D, TD95D, TL100, TL70, TL80, TL90	5165549	
<b>71600</b>	Compressore aria condizionata adattabile rif. Sanden SD7849/Air conditioning compressor adaptable ref. Sanden SD7849	<b>SAME LAMBORGHINI HURLIMANN SAME</b>	DORADO 55, DORADO 56 - 56 EXPORT USA, DORADO 56 CLASSIC, DORADO 60, DORADO 65, DORADO 66, DORADO 66 - 66 EXPORT USA, DORADO 66 CLASSIC, DORADO 70, DORADO 75, DORADO 76 - 76 EXPORT USA, DORADO 76 CLASSIC, DORADO 85, DORADO 86 - 86 EXPORT USA, DORADO 86 CLASSIC, EXPLORER 75 NEW AND CLASSIC, EXPLORER 85, EXPLORER 95 NEW AND CLASSIC, LASER 100, LASER 110, LASER 125, LASER 130, LASER 140, LASER 150, LASER 160, ROLLER 55 W, ROLLER 70 W, ROW CROP 100.6, SILVER 100.4, SILVER 100.6, SILVER 105, SILVER 110, SILVER 80, SILVER 85, SILVER 90, SILVER 95, TITAN 160, TITAN 190	0.009.7660.4	

# 1.7.23 Ricambi vari

Various parts



## Ricambi & accessori per macchine agricole

### SPARE PARTS & ACCESSORIES FOR AGRICULTURAL MACHINE

Tutti gli articoli della presente sezione, prodotti da AMA SPA e/o da terzi per conto di AMA, sono adattabili ("non originali") alle marche indicate ai sensi di quanto previsto dal REG. CE n. 1400/2002. I diritti sui marchi citati appartengono ai legittimi proprietari ed il loro uso ha l'esclusiva finalità di consentire all'utilizzatore la comparazione dei diversi prodotti. All items of this section, manufactured by AMA SPA and/or any third party on behalf of AMA, are adaptable ("non-original") to the brands listed under the provisions of the REG. CE n. 1400/2002. The rights on the trademarks belong to their respective owners and their usage is only aimed to allow the user to compare different products.

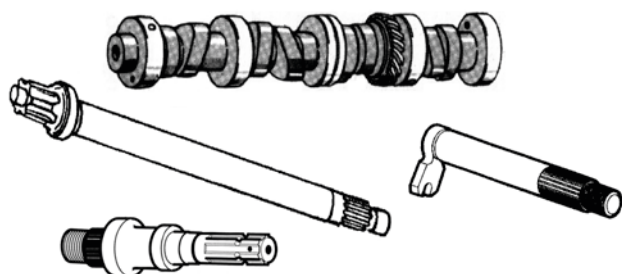
**ALBERI ADATTABILI E ORIGINALI**
*ARBRES ADAPTABLES ET ORIGINAUX*
*SHAFTS ADAPTABLE AND ORIGINAL*
*SCHÄFTE ANPASSBARE UND ORIGINALE*
*ÁRBOLES ADAPTABLES Y ORIGINALES*

Art./Ref.	Note/Notes	Tipo/Type	Brand	Applicazione/Application	Rif. Orig./Orig. Ref.	
15139	Rinvio SX	Adattabile	FIAT		5107127, 583321	
15166	Trasmissione	Adattabile				5108331
17255	Trasmissione	Adattabile				5121036
26472	Motore	Adattabile				4785107
26479	Freno	Adattabile				44904468, 5167492
26480	Freno	Adattabile				44908536
26520	Pignone	Adattabile				4965104
27753	Distribuzione	Adattabile			100C, 120C, 1300, 1300S, 650, 655, 655C	4752190, 8814921
29170	Motore	Adattabile				4975246
29907	Presa di forza	Adattabile			850 DTS, 1000 DTS, 1300 DTS, 850 DTS-1000 DTS-1300 DTS	44012143
72999	Motore	Adattabile				4653850
17259R	Trasmissione	Adattabile				5153179, 5166835
N04970654	Presa di forza	Adattabile				4970654
N04974393	Cambio	Adattabile				4974393
N04997343	Presa di forza	Adattabile				4997343
N05101779	Presa di forza	Adattabile				5101779
N05110196	Assale	Adattabile				5110196
N05110197	Assale	Adattabile				5110197
N05114989	Assale	Adattabile				5114989
N05114994	Sterzo	Adattabile				5114994
N05114996	Sterzo	Adattabile				5114996
N05125528	Presa di forza	Adattabile				5125528
N05130154	Assale	Adattabile				5130154
N05131167	Cambio	Adattabile				5131167
N05144052	Assale posteriore	Adattabile				5144052
N0566253	Presa di forza	Adattabile				566253
N0566473	Presa di forza	Adattabile				566473
N0596736	Presa di forza	Adattabile				596736
N09928666	Sterzo	Adattabile				9928666
N09962249	Sterzo	Adattabile				9962249
NH5114993	Sterzo	Originale		NEW HOLLAND	100.90 DT, 90.90 DT	5114993
NH5119042	Sterzo	Originale			1180 DT	5119042
NH5142803	Sterzo	Originale			F115 DT	5142803
NH5159948	Motore	Originale				5159948
NH5165619	Sterzo	Originale	M160, 180.90 DT		5165619	
NH89840406	Presa di forza	Originale			89840406	
NH83959984	Presa di forza	Originale			83959984	
NH47130744	Presa di forza	Originale			47130744	
NH5110196	Semialbero - Trasmissione	Originale				5110196

Art./Ref.	Note/Notes	Tipo/Type	Brand	Applicazione/Application	Rif. Orig./Orig. Ref.
<b>40001</b>	Motore	Adattabile	<b>FORD</b>		81815395, E2006T9
<b>41509</b>	Motore	Adattabile		4830, 5000, 5030, 5110, 5600, 5700, 5900, 6410, 6600, 6610, 655, 655A/C, 6700, 6710, 6810, 7000, 7410, 7600, 7610, 7700, 7710, 555C	87800353
<b>42480</b>	Preso di forza	Adattabile		8770, 8870, 8970	89840406
<b>22400</b>	Preso di forza - 306 mm - 6 cave	Adattabile		5000, 7000, 5110, 5600, 5610, 5700, 6410, 6600, 6610, 6700, 6710, 6810, 7410, 7600, 7610, 7700, 7710	83947133, D2NN N752B
<b>21893</b>	Trasmissione	Adattabile		2000, 2310, 2600, 2610, 3000, 3600, 3610, 4110	81820864, C7NN 7017AB
<b>22623</b>	Sterzo	Adattabile		5000, 5110, 5340, 5600, 5610, 5900, 6410, 6600, 6610, 7000, 7600, 7610	81803120, C5NN 3575A
<b>LN1432044M1</b>	Preso di forza	Originale	<b>LANDINI</b>		1432044M1
<b>40017</b>	Motore - Versione con brocciatura anteriore e semitreccia posteriore	Adattabile	<b>MASSEY FERGUSON</b>		3637472M91
<b>40002</b>	Motore	Adattabile			3641858M91
<b>41058</b>	Preso di forza - 6 cave	Adattabile		SERIE 2000, PRIMA VERSIONE	3042960M2
<b>11758</b>	Z = 18/	Adattabile		135, 240	964926M3
<b>11802</b>	Sterzo	Adattabile		265, 275, 285, 290	1675411M91
<b>40005R</b>	Motore	Adattabile			3638473M91
<b>40013R</b>	Motore	Adattabile			742681M91
<b>VO.9022.720.0</b>		Originale			0.9022.720.0
<b>VO.9104.720.0/3</b>		Originale		0.9104.720.0/30	
<b>VO.275.4634.0/2</b>	Ruota	Originale	<b>SAME</b>	0.275.4634.0/20	
<b>VO.270.2510.3</b>		Originale		0.270.2510.3	
<b>VO.255.3652.0/2</b>	Preso di forza	Originale		0.255.3652.0/20	
<b>VO.188.3661.0</b>	Preso di forza	Originale		0.188.3661.0	
<b>40009</b>	Motore - Versione anteriore chiave, posteriore paraolio	Adattabile	<b>PERKINS</b>	APPLICAZIONI VARIE	ZZ90111
<b>VALTRA30310300</b>	Rinvio	Originale	<b>VALTRA</b>		V30310300

**BARRE ADATTABILI FIAT / FORD**

BARRES ADAPTABLES FIAT / FORD

BARS ADAPTABLE FIAT / FORD

BARS PASSEND ZU FIAT / FORD

BARRAS ADAPTABLE FIAT / FORD

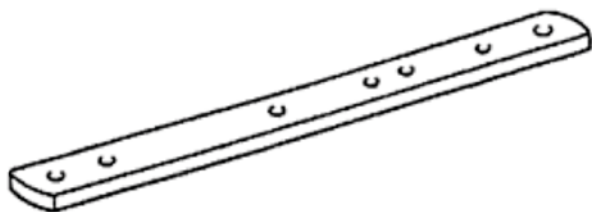

Art./Ref.	Descrizione estesa/Extended Description	Brand	Applicazione/Application	Rif. Orig./Orig. Ref.
<b>17273</b>	Estremità barra di traino adattabile a rif. Orig. Fiat 5121552	<b>FIAT</b>		5121552, 5135330
<b>17275</b>	Barra di traino adattabile a rif. orig. Fiat 5118977		5118977, 5171100	
<b>19258</b>	Barra di traino adattabile a rif. orig. Fiat 5128655		5128655	
<b>19260</b>	Barra di traino adattabile a rif. orig. Fiat 5123641		5123641	
<b>19261</b>	Barra di traino adattabile a rif. orig. Fiat 5117439		5117439	
<b>19259</b>	Barra di traino adattabile a rif. Orig. Fiat 5126716		5126716	
<b>17177</b>	Barra stabilizzatrice adattabile a rif. Orig. Fiat 4961078		4961078	
<b>42973</b>	Barra per snodi sterzo adattabile a rif. orig. Ford 5178665, filetto 24 x 1,5	<b>FORD</b>	4635, 4835, 5635 6635, 7635, 4635, 4835, 5635, 6635, 6735	5178665

**BOCCOLE ADATTABILI E ORIGINALI**

DOUILLES ADAPTABLES ET ORIGINALES  
 BUSHES ADAPTABLE AND ORIGINAL  
 BUCHSE ANPASSBAR UND ORIGINAL  
 BUJES ADAPTABLES Y ORIGINALES



Art./Ref.	Descrizione estesa/Extended Description	Tipo/Type	Brand	Applicazione/Application	Rif. Orig./Orig. Ref.	
<b>29914</b>	Boccola adattabile a rif. orig. Fiat 89824066	Adattabile	<b>FIAT</b>	G170, G190, G210, G240	89824066	
<b>15510</b>	Boccola per ponte anteriore adattabile a rif. orig. Fiat 5102972	Adattabile		90.90DT, 100.90DT, 110.90DT	4997698, 5102972	
<b>27493</b>	Boccola adattabile a rif. orig. Fiat 5107725	Adattabile		115.90, 130.90, 140.90, 160.90, 1180, 1280, 1380, 1580, 1880, 180.90, M100, M115, M135	5107725	
<b>27968</b>	Boccola supporto perni attacco attrezzi adattabile a rif. orig. Fiat 5164031	Adattabile		M100-M115-M135-M160-TM115, TM140-TM150-TM155-TM165	5164031	
<b>16922</b>	Boccola per leva adattabile a rif. orig. Fiat 4962576	Adattabile			4962576	
<b>16446</b>	Boccola adattabile a rif. orig. Fiat 4971683	Adattabile			4971683, 554921	
<b>15178</b>	Boccola adattabile a rif. orig. Fiat 5120207	Adattabile			5120207, 8273912	
<b>16370</b>	Boccola adattabile a rif. orig. Fiat 4960193	Adattabile			4960193	
<b>14855</b>	Boccola sinistra adattabile a rif. Orig. Fiat 5137993	Adattabile			5137993	
<b>29314</b>	Boccola adattabile a rif. Orig. Fiat 71405159	Adattabile			71405159, 71410059	
<b>N0599367</b>	Boccola adattabile a rif. Orig. Fiat 599367	Adattabile			599367	
<b>NH87538599</b>	Boccola di gomma originale Fiat rif. 87538599	Originale		<b>NEW HOLLAND</b>		87538599
<b>NH87538600</b>	Boccola di gomma originale Fiat rif. 87538600	Originale				87538600
<b>NH44011093</b>	Boccola originale fiat rif. 44011093	Originale				44011093
<b>NH87376924</b>	Boccola originale fiat rif. 87376924	Originale			87376924	
<b>V0.9016.322.0</b>	Boccola 80 x 70 x 129 originale Same rif. 0.9016.322.0	Originale	<b>SAME</b>		0.9016.322.0	

**BULLONI ADATTABILI E ORIGINALI**

BOULONS ADAPTABLES ET ORIGINAUX  
 BOLTS, ADAPTABLE AND ORIGINAL  
 BOLZEN ANPASSUNGSFÄHIG UN ORIGINAL  
 PERNOS ADAPTABLES Y ORIGINALES



Art./Ref.	Descrizione estesa/Extended Description	Tipo/Type	Brand	Applicazione/Application	Rif. Orig./Orig. Ref.
<b>40072</b>	Bullone per biella adattabile a rif. orig. Ford 81803991	Adattabile	<b>FORD</b>		81803991
<b>40078</b>	Bullone biella adattabile a rif. Orig. Massey Ferguson 3637029M1	Adattabile	<b>MASSEY FERGUSON</b>		3637029M1
<b>40987</b>	Bullone adattabile a rif. Orig. Massey Ferguson 825776M1	Adattabile		35, 135, 148, 155, 158, 165,, 690, 698, 699, 1200, 1250	825776M1
<b>NH135270</b>	Bullone originale Fiat 135270	Originale	<b>NEW HOLLAND</b>		135270
<b>NH87327171</b>	Bullone originale Fiat rif. 80450644	Originale			87327171
<b>NH88206</b>	Bullone originale Fiat rif. 88206	Originale			88206

**CANNE PISTONI FINITE E SEMIFINITE, ADATTABILI**

PISTONS FINIS ET SEMI-FINIS, ADAPTABLES  
 FINISHED AND SEMIFINISHED LINER, ADAPTABLE  
 KOLBEN FINITE UND SEMIFINITE, ANPASSBAR  
 PISTONES FINITA Y SEMIFINITA, ADAPTABLE



Art./Ref.	Descrizione estesa/Extended Description	Tipo/Type	Brand	Applicazione/Application	Rif. Orig./Orig. Ref.
26925	Canna cilindri adattabile a rif. Orig. Fiat	Adattabile	FIAT		4770624
40114	Canna semifinita adattabile a rif. orig. Ford 81803819	Adattabile	FORD		81803819
21680	Canna finita adattabile a rif. orig. Ford 81710303	Adattabile		81710303, E1ADDN6055E	
21677R	Canna adattabile a rif. Orig. Ford C5NN6055A	Adattabile		81815327, C5N-N6055A	
40119	Canna finita adattabile a rif. orig. Massey Ferguson 744948M1	Adattabile	LANDINI	10000, 10000S, 12500, 13000, 14500, 16000, 16500, 6500, 6550, 6830, 6840, 6860, 6870, 6880, 7000 SPECIAL, 7000/DT, 7000R, 7500, 7550, 7830, 7860, 7870, 7880, 9500, ADVANTAGE CAB E F.S.: 75, ADVANTAGE CAB E F.S.:65, BLIZZARD : 75, BLIZZARD :65, C10500, C6500, CINGOLATI: CF6830, CINGOLATI:C6830, FRUTTETI 530F/L/V: 7530, FRUTTETI 530F/L/V:6530, FRUTTETI 560/F/L/V: 7560, FRUTTETI 560/F/L/V:6560, TREKKER : CF65, TREKKER : CF70, TREKKER : CF75, TREKKER :C75, VIGNETI CAB E F.S. : 75V, VIGNETI CAB E F.S. :65V	
40099	Canna semifinita adattabile a rif. Orig. 740571M1	Adattabile		8000/DT, 8000R, 8500, 8550, 8830, 8860, 8870, 8880, ADVANTAGE CAB E F.S.:85, BLIZZARD :85, CINGOLATI :C7800, CINGOLATI :C7830, CINGOLATI :C8860, FRUTTETI 530F/L/V:8530, FRUTTETI 560F/L/V:8560, TREKKER :C85, TREKKER :CF85	
40156	Canna semifinita adattabile a rif. Orig. Massey Ferguson 734644M1	Adattabile	MASSEY FERGUSON		734644M1
40142	Canna semifinita adattabile a rif. Orig. Massey Ferguson 745990M1	Adattabile		745990M1	
40135	Canna semifinita adattabile a rif. Orig. Massey 737214M1	Adattabile		737214M1	
40115	Canna finita adattabile a varie applicazioni Massey Ferguson / Ford	Adattabile		3.144	
40233	Canna finita adattabile a rif. orig. Massey Ferguson 106 594F	Adattabile	PERKINS		106594F
40102	Canna semifinita adattabile a rif. Orig. Perkins 31358323C	Adattabile		31358323C	

**CAVO ADATTABILE E ORIGINALE**

CABLE ORIGINAL ET ADAPTABLE  
 CABLE ORIGINAL AND ADAPTABLE  
 KABEL ORIGINAL UND PASSEND ZU  
 CABLE ORIGINAL Y ADAPTABLE



Art./Ref.	Descrizione estesa/Extended Description	Tipo/Type	Brand	Rif. Orig./Orig. Ref.
27930	Cavo flessibile adattabile a rif. Orig. Fiat 44906621	Adattabile	FIAT	44906621, 5172113
27931	Cavo adattabile a rif. orig. Fiat 85806155	Adattabile		85806155
NH82014250	Cavo elettrico originale Fiat rif. 82014250	Originale	NEW HOLLAND	82014250
NH86024316	Cavo originale Fiat rif. 86024316	Originale		86024316
NH89820913	Cavo elettrico originale Fiat rif. 89820913	Originale		89820913
VO.012.6729.3/1	Cavo stop motore originale Same rif. 0.012.6729.3/10	Originale	SAME	0.012.6729.3/10



**CILINDRI ORIGINALI E ADATTABILI**

CYLINDRE ORIGINAL ET ADAPTABLE  
CYLINDERS ORIGINAL AND ADAPTABLE  
ZYLINDER ORIGINAL UND PASSEND ZU  
CILINDROS ORIGINAL Y ADAPTABLE

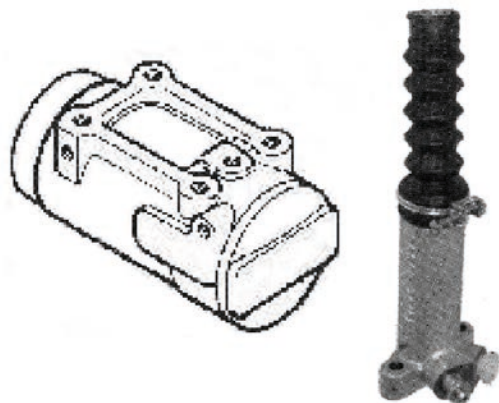

Art./Ref.	Tipo/Type	Descrizione estesa/Extended Description	Brand	Rif. Orig./Orig. Ref.
<b>27438</b>	Adattabile	Cilindro adattabile a rif. Orig. Fiat 5178707	<b>FIAT</b>	772459
<b>N05178707</b>	Adattabile	Cilindro adattabile a rif. Orig. Fiat 5178707		5178707
<b>NH5130380</b>	Originale	Cilindro originale Fiat rif. 5130380	<b>NEW HOLLAND</b>	5130380
<b>V0.044.1120.0/4</b>	Originale	Cilindro originale Same rif. 0.044.1120.0/40	<b>SAME</b>	0.044.1120.0/40

**COPERCHI ORIGINALI E ADATTABILI**

COUVERTURES ORIGINALES ET ADAPTABLES  
COVERS ORIGINAL AND ADAPTABLE  
ABDECKUNGEN ORIGINAL UND ANPASSBARE  
CUBIERTAS ORIGINALES Y ADAPTABLES

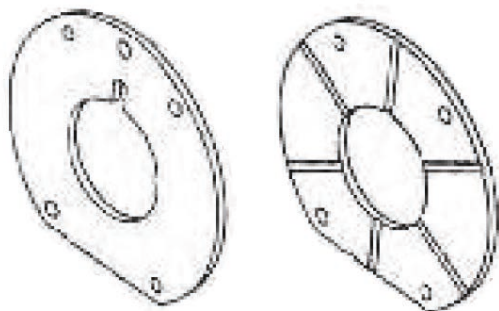

Art./Ref.	Descrizione estesa/Extended Description	Tipo/Type	Brand	Rif. Orig./Orig. Ref.
<b>27572</b>	Coperchio adattabile a rif. orig. Fiat 5178130	Adattabile	<b>FIAT</b>	5178130
<b>73049</b>	Coperchio adattabile a rif. orig. Fiat 564951	Adattabile		564951
<b>27617</b>	Coperchio adattabile a rif. orig. Fiat 555056	Adattabile		555056, 76008657
<b>LN3545528M1</b>	Coperchio originale Landini rif. 3545528M1	Originale	<b>LANDINI</b>	3545528M1
<b>V0.434.4433.0</b>	Coperchio originale Same rif. 0.434.4433.0	Originale	<b>SAME</b>	0.434.4433.0

**DADI ADATTABILI E ORIGINALI**

ECROUS ADAPTABLES ET ORIGINAUX  
NUTS, ADAPTABLE AND ORIGINAL  
NUTS, ADAPTABLE AND ORIGINAL  
NUECES ADAPTABLES Y ORIGINALES

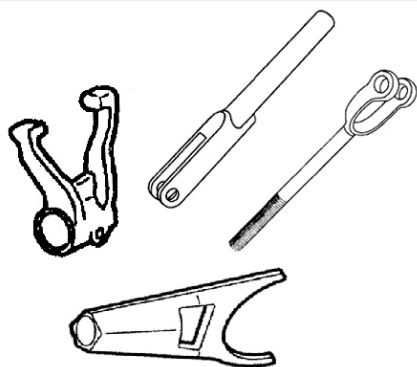

Art./Ref.	Descrizione estesa/Extended Description	Tipo/Type	Brand	Applicazione/Application	Rif. Orig./Orig. Ref.
27625	Dado per comando di distribuzione adattabile a rif. orig. Fiat/Ford 4338920	Adattabile	FIAT	250-300-300J, 215-215M-220-220C, 420-450-450R-470-480/8, 55.46-45.66-50.66-55.66-60.66, 55.90-60.90-60.93-60.94, 880.5-955C, 90.90, 95.55, 980-1000S-1180-1280-1380	4025654, 4338920
14645	Dado adattabile a rif. orig. Fiat 5142367	Adattabile		1180-1280-1380-1580-1880	5105791, 5142367
27573	Dado adattabile a rif. orig. Fiat/Ford 12164224	Adattabile		850 DTS-1000 DTS-1300 DTS, F100 -F110-F115-F120-F130, F140, L60-L65-L75-L85-L95-TL70-TL80, M100-M115-M135-M160-TM115, TL90 - TL100, TM120-TM165	12164221, 12164224
26891	Dado adattabile a rif. orig. Fiat 5116857	Adattabile			5116857
19081	Dado adattabile a rif. orig. Fiat 4842797	Adattabile			4842797
27663	Dado adattabile a rif. orig. Fiat 4957353	Adattabile			4957353
26450	Dado adattabile a rif. Orig Fiat 16109211	Adattabile			16109211, 16109221, 5115377
27974	Dado corona adattabile a rif. Orig. Fiat 11695811	Adattabile			11695811
29853	Dado adattabile a rif. Orig. Fiat 10721021	Adattabile			10721021
14641	Dado adattabile a rif. orig. Fiat 5123113	Adattabile			640, 65.46, TD55D, TD65D
NH247780	Dado originale Fiat rif. 247780	Originale	NEW HOLLAND		247780
NH1306680C1	Controdado originale Fiat rif. 1306680C1	Originale			1306680C1
40071	Dado biella motore adattabile a rif. orig. Landini 391057X1	Adattabile	LANDINI	4000/DT, 4000R, 4000S, 4500R, 5000/DT, 5000/N, 5000/S, 5000R, 5500, 5830, 5840, 5860, 5860 (DAL P50187, 5870, 5870 (DAL P50187), 6000/DT, 6000/S, 6000R, 6030, 6040, 6060, 6060(DAL P50187), 6070, 6070 (DAL P50187), 7000R, ADVANTAGE CAB E F.S.:55, ADVANTAGE CAB E F.S.:60, ADVANTAGE CAB E FOOT STEP: 55, ALPINE:65, ALPINE:75, ALPINE:85, APPLICAZIONI DIVERSE, BLIZZARD :60, BLIZZARD:50, C6000, CINGOLATI: C5500, CINGOLATI: C5830, CINGOLATI: CF4830, CINGOLATI: CF5030, CINGOLATI: CF5830, CINGOLATI: CF6060, CINGOLATI:C4500, CINGOLATI:C4830, CINGOLATI:C5000, CINGOLATI:CF6030, FRUTTETI 530F/L/V: 5530, FRUTTETI 530F/L/V:4530, FRUTTETI 530F/L/V:6030, FRUTTETI 560 F/L/V:5560V/L, FRUTTETI 560 F/L/V:6060V/L, FRUTTETI 560F/L/V :6060, FRUTTETI 560F/L/V: 5560, FRUTTETI 560F/L/V:4560, GLOBUS :55, GLOBUS:50, NEW SERIE 60:5860, POWER FARM:60, REX CAB E F.S. :60, REX CAB E FOOT STEP:60, REX NEW TIER 2:60, SERIE 60 NEW:5860, TREKKER :CF55, TREKKER COMPACT TIER 2:CF60, TREKKER COMPACT TIER 2:CF70, TREKKER:CF60, VIGNETI CAB E FOOT STEP :55V, VIGNETI CAB E FOOT STEP :60V, VIGNETI REX CAB :60V, VIGNETI REX CAB :65V, VIGNETI REX CAB :65V.	1476245X1, 33221327, 391057X1
40077	Dado biella motore adattabile a rif. orig. Perkins 33221328	Adattabile		10000, 14500, 16000, 16500, 6500, 6550, 6830, 6840, 6860, 6870, 6880, 7000 SPECIAL, 7000/DT, 7000R, 7500, 7550, 7830, 7860, 7870, 7880, 8000/DT, 8000R, 8500, 8550, 8830, 8860, 8870, 8880, 9060, 9080, 9500, 9880, ADVANTAGE CAB E F.S.: 75, ADVANTAGE CAB E F.S.:65, ADVANTAGE CAB E F.S.:85, ADVANTAGE CAB:L95, ATLAS :75, ATLAS :85, BLIZZARD :65, BLIZZARD :75, BLIZZARD :85, BLIZZARD:95, C10500, C6500, CINGOLATI : C6830, CINGOLATI : C7830, CINGOLATI :C6500, CINGOLATI :C7800, CINGOLATI :C8860, CINGOLATI :CF6830, FRUTTETI 530F/L/V:6530, FRUTTETI 530F/L/V:7530, FRUTTETI 530F/L/V:8530, FRUTTETI 560F/L/V: 7560, FRUTTETI 560F/L/V:6560, FRUTTETI 560F/L/V:7530, FRUTTETI 560F/L/V:8560, LEGEND 105, LEGEND 115, LEGEND 130, LEGEND 145, LEGEND 165, LEGEND N/G:115, NEW SERIE 60:7860, NEW SERIE 60:8860, TREKKER : CF85, TREKKER :C75, TREKKER :C85, TREKKER :C95, TREKKER :CF65, TREKKER :CF70, TREKKER :CF75, VIGNETI CAB E F.S. : 75V, VIGNETI CAB E F.S. :65V	3637030M1
40985B	Dado tipo IMT	Adattabile	MASSEY FERGUSON		532956M1

**FORCELLE ADATTABILI ORIGINALI E**
*FOURCHES ORIGINALES ET ADAPTABLES*
*FORKS ORIGINAL AND ADAPTABLE*
*GABELN ORIGINAL UND ANPASSBARE*
*HORQUILLAS ORIGINALES Y ADAPTABLES*

Art./Ref.	Descrizione estesa/Extended Description	Tipo/Type	Brand	Applicazione/Application	Rif. Orig./Orig. Ref.
27920	Forcella adattabile a rif. orig. Fiat 5123278	Adattabile	FIAT	1180, 12890, 1380, 1580, 1880 F100, F110, F115, F120, F130, F140, M100, M115, M135, TM115, TM120, TM125, TM130, TM140	5123278, 5162012
27911	Forcella adattabile a rif. orig. Fiat 5109389	Adattabile			5109389
29186	Forcella adattabile a rif. orig. Fiat 5149612	Adattabile			5149612, 5149612
17262	Forcella adattabile a rif. Orig. Fiat 5163626	Adattabile			5163626
27917	Forcella adattabile rif. orig. Fiat 5151045	Adattabile			5151045
27901	Forcella inferiore adattabile a rif. orig. Fiat 44018159	Adattabile			44012242, 44018159
LN1424290M2	Forcella originale Landini rif. 1424290M2	Originale	LANDINI		1424290M2
V02331826	Forcella originale Same rif. 02331826	Originale	SAME		02331826

**FUSELLI SNODO ADATTABILI E ORIGINALI**
*BROCHES ORIGINAL ET ADAPTABLE*
*SPINDLES ORIGINAL AND ADAPTABLE*
*SPINDELN ORIGINAL AND PASSEND ZU*
*HUSILLOS ORIGINAL Y ADAPTABLE*

Art./Ref.	Descrizione estesa/Extended Description	Tipo/Type	Brand	Applicazione/Application	Rif. Orig./Orig. Ref.
N05141709	Fuso snodo adattabile a rif. Orig. Fiat 5141709	Adattabile	FIAT		5141709
N05150443	Snodo barra flessibile adattabile a rif. Orig. Fiat 5150443	Adattabile		5150443	
N04971979	Fuso adattabile a rif. orig. Fiat 4971979	Adattabile		4971979	
N05145938	Fuso a snodo adattabile a rif. orig. Fiat 5145938	Adattabile		5145938	
NH44906723	Fuso a snodo originale Fiat rif. 44906723	Originale	NEW HOLLAND		44906723
NH5127197	Fuso snodo destro rif. Orig. Fiat 5127197	Originale		5127197	
NH5126940	Fuso snodo originale Fiat rif. 5126940	Originale		5126940	
NH5119699	Snodo sferico originale Fiat rif. 5119699	Originale		5119699	
NH5127196	Fuso snodo originale Fiat rif. 5127196	Originale		5127196	
NH5145936	Fuso destro originale Fiat rif. 5145936	Originale		5145936	
NH5145938	Fuso sinistro originale Fiat rif. 5145938	Originale	5145938		
22120	Fusello destro adattabile a rif. orig. Ford 81821185	Adattabile	FORD		81821185, E1ADKN-3105
22124	Fusello sinistro adattabile a rif. orig. Ford 81817058	Adattabile		4000	81817058, C5NN 3106N
11836	Fuso a snodo adattabile a rif. Orig. Massey Ferguson 897236M94	Adattabile	MASSEY FERGUSON	250, 255 STERZO MANUALE	897236M94
11833	Fuso a snodo adattabile a rif. Orig. Massey Ferguson 897415M91	Adattabile		180349M92, 897415M91	
41205	Fusello destro adattabile a rif. orig. Massey Ferguson 883569M93	Adattabile		165, 265, 290	883569M93
41206	Fusello sinistro adattabile a rif. Orig. Massey Ferguson 883570M93	Adattabile		165, 265, 290	883570M93
V0.008.5451.2	Snodo sferico originale Same rif. 0.008.5451.2	Originale	SAME		0.008.5451.2

## INGRANAGGERIA ADATTABILE E ORIGINALE

ENGRENAGES ADAPTABLES ET ORIGINAL

GEARS, ADAPTABLE AND ORIGINAL

ZAHNRÄDER ANPASSBARE UND ORIGINAL

ENGRANAJES ADAPTABLES Y ORIGINALES

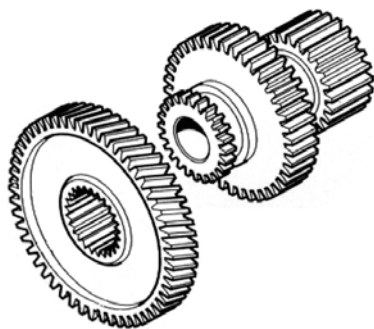

Art./Ref.	Descrizione estesa/Extended Description	Tipo/Type	Brand	Applicazione/Application	Rif. Orig./Orig. Ref.
12961	Sincronizzatore adattabile rif. orig. Fiat 980062	Adattabile	FIAT	1300S, 1300DTS, 850S, 850DTS, 1000S, 1000DTS	44012113, 980062
75791	Sincronizzatore adattabile rif. orig. Fiat 5161828	Adattabile		60-66, 60-93, 60-94, 62-86, 65-66S, 65-94, 70-66S, 72-86, 72-93, 72-94, 82-86, 82-94, L-95, L60, L75, SERIE 55-66S, TD55D, TD60, TD65D, TD70, TD75D, TD85D, TD90D, TD95D	5161828
18925	Planetario lato destro adattabile a rif. orig. Fiat 5103869	Adattabile		640, 65.46, TD55D, TD65D, L60, L65, L75, L85, L95, TL70, TL80, TL90, TL100, TN, TND, TNS, TNF	4970770, 5103869
18924	Planetario lato sinistro adattabile a rif. orig. Fiat 5103868	Adattabile		640, 65.46, TD55D, TD65D, 90.90DT, 100.90DT, 110.90DT, L60, L65, 75, L, 85, L95, TL70, TL80, TL90, TL100, TN, TND, TNS, TNF,	4970769, 5103868
26564	Ingranaggio adattabile a rif. orig. Fiat 5102792	Adattabile		640, 65.46	5102792
10639	Ingranaggio adattabile a rif. orig. Fiat 5102789	Adattabile		1180, 115.90, 880	5102789
27512	Ingranaggio per attacco attrezzi adattabile a rif. orig. Fiat 5125394	Adattabile		L65, 55.66-60.66-60.90-60.93-60.94, 65.66-65.88-65.90-65.93-65.94, 70.66-70.90-72.93-72.94, 80.66-80.90-82.93-82.94, 82.94-85.90-88.93-88.94-L60	5125394
14873	Coppia conica adattabile a rif. Orig. Fiat 5115802	Adattabile			5115802, 5117043
18929	Ingranaggio adattabile a rif. orig. Fiat 5102790	Adattabile		640, 65.46	5102790
26563R	Ingranaggio adattabile a rif. Orig. Fiat 5102794	Adattabile			5102794
26440R	Coppia conica adattabile a rif. Orig. Fiat 5117047	Adattabile			5117047
27494R	Coperchio ingranaggio posteriore adattabile a rif. orig. Fiat 4680242	Adattabile			4680242
28142R	Ralla dentata Z = 17 adattabile a rif. orig. Fiat 5127573	Adattabile			5127573
N04963075	Planetario adattabile a rif. orig. Fiat 4963075	Adattabile			4963075
N05149950	Ingranaggio adattabile a rif. orig. Fiat 5149950	Adattabile			5149950
N0566396	Ingranaggio adattabile a rif. orig. Fiat 566396	Adattabile			566396
N05129672	Ingranaggio adattabile a rif. orig. Fiat 5129672	Adattabile			5129672
N05116990	Ingranaggio adattabile a rif. orig. Fiat 5116990	Adattabile			5116990
N05100354	Ingranaggio adattabile a rif. Orig. Fiat 5100354	Adattabile			5100354
N04984366	Ingranaggio adattabile a rif. Orig. Fiat 4984366	Adattabile			4984366
N0566254	Ingranaggio adattabile a rif. Orig. Fiat 566254	Adattabile			566254
N04981410	Ingranaggio adattabile a rif. Orig. Fiat 4981410	Adattabile			4981410
N0588673	Ingranaggio adattabile a rif. Orig. Fiat 58867	Adattabile			588673
N04747597	Ingranaggio adattabile a rif. Orig. Fiat 4747597	Adattabile			4747597
N04980608	Coppia conica adattabile a rif. orig. Fiat 4980608	Adattabile			4980608
N047135643	Coppia conica adattabile a rif. orig. Fiat 47135643	Adattabile			47135643
N04979422	Coppia conica adattabile a rif. orig. Fiat 4979422	Adattabile			4979422
N05142249	Coppia conica adattabile a rif. Orig. Fiat 5142249	Adattabile			5142249
N04998878	Satellite adattabile a rif. Orig. Fiat 4998878	Adattabile			4998878
N05100509	Satellite z.19 adattabile a rif. Orig. Fiat 5100509	Adattabile			5100509
N0868987	Corona adattabile a rif. Orig. Fiat 868987	Adattabile			868987
N0567625	Corona dentata adattabile a rif. Orig. Fiat 567625	Adattabile			567625
N0591460	Scatola sterzo adattabile a rif. orig. Fiat 591460	Adattabile		591460	

Art./Ref.	Descrizione estesa/Extended Description	Tipo/Type	Brand	Applicazione/Application	Rif. Orig./Orig. Ref.
<b>N0564685</b>	Scatola sterzo adattabile a rif. orig. Fiat 564685	Adattabile	<b>FIAT</b>		564685
<b>N05102649</b>	Scatola differenziale adattabile a rif. Orig Fiat 5102649	Adattabile		5102649	
<b>N04996747</b>	"Scatola differenziale adattabile a rif. Orig Fiat 4996747	Adattabile		4996747	
<b>NH4989825</b>	Scatola differenziale originale Fiat rif. 4989825	Originale	<b>NEW HOLLAND</b>		4989825
<b>NH5143850</b>	Sincronizzatore originale Fiat rif. 5143850	Originale//Original		5143850	
<b>NH5158933</b>	Sincronizzatore cambio originale Fiat rif. 5158933	Originale//Original		5158933	
<b>NH5125750</b>	Planetario destro originale Fiat rif. 89820913	Originale		5125750	
<b>NH566254</b>	Ingranaggio originale Fiat rif. 566254	Originale		566254	
<b>19115</b>	Ingranaggio per bilanciatore adattabile a rif. orig. Ford 4600376	Adattabile	<b>FORD</b>	4835,5635, 6635,7635	4600376
<b>40294</b>	Ingranaggio contrappeso per bilanciatore adattabile a rif. orig. Massey Ferguson 31164582	Adattabile	<b>LANDINI</b>	6500, 6550, 6830, 6840, 7500, 7550, 7830, 8000/DT, 8000R, 8500, 8550, 8830, C6500, CINGOLATI:C6500, CINGOLATI:C7800, FRUTTETI 530 F/L/V:8530, FRUTTETI 530F/L/V: 7530, FRUTTETI 530F/L/V:6530	
<b>LN1823647M3</b>	Corona originale Landini rif. 1823647M3	Originale		1823647M3	
<b>LN3535281M1</b>	Pignone originale Landini rif. 3535281M1	Originale		3535281M1	
<b>LN3549874M1</b>	Pignone originale Landini rif. 3549874M1	Originale		3549874M1	
<b>40924</b>	Ingranaggio per trasmissione 8 velocità adattabile a rif. orig. Massey Ferguson 906469M1. Z= 45	Adattabile	<b>MASSEY FERGUSON</b>	265, 275, 565, 575	906469M1
<b>40883</b>	Ingranaggio trasmissione 2 velocità (Z = 36 / Z = 18 / 18 calettature) adattabile a rif. orig. Massey Ferguson 180416M1	Adattabile		180416M1	
<b>40980</b>	Kit coppia conica adattabile a rif. orig. Massey Ferguson 1885317M93, composto da 1pz 182115M91, 1pz 831485M1, 1pz 825776M1, 1pz 891947M1	Adattabile		1885317M93	
<b>11810</b>	Scatola sterzo adattabile a Massey Ferguson rif. orig. 1853098M1	Adattabile		1853098M1, 1853098M91	
<b>11752</b>	Ingranaggio 2°/4° tipo adattabile a rif. orig. Massey Ferguson 891904M1	Adattabile		891904M1	
<b>V0.255.3340.0</b>	Anello sincronizzatore originale Same rif. 0.255.3340.0	Originale//Original		<b>SAME</b>	
<b>V0.148.4620.3</b>	Coppia conica originale Same rif. 0.148.4620.3	Originale	0.148.4620.3		
<b>V0.275.4622.3/1</b>	Gruppo satelliti e planetari originale Same rif. 0.275.4622.3/10	Originale	0.275.4622.3/10		
<b>40169</b>	Ingranaggio albero a camme adattabile a rif. orig. Massey Ferguson 0410231	Adattabile	<b>PERKINS</b>	6000/DT, 6000/S, 6000R, 7000R, APPLICAZIONI VARIE, C6000	0410231, 410231
<b>40171</b>	Ingranaggio intermedio Z = 48 per distribuzione adattabile a rif. orig. Massey Ferguson 411150004, Z = 48	Adattabile		6000/DT, 6000/S, 6000R, 7000R, APPLICAZIONI VARIE, C6000	41115004
<b>PK0410264</b>	Ingranaggio d'avviamento originale Perkins rif. 0410264	Originale		0410264	
<b>PK0410236</b>	Corona d'avviamento originale Perkins rif. 0410236	Originale		0410236	

**KIT BRONZINE ADATTABILI**

KITS DE BRONZINE ADAPTABLES

BEARINGS KIT ADAPTABLE

BRONZINE KITS PASSEND ZU

KITS DE BRONCEO ADAPTABLES

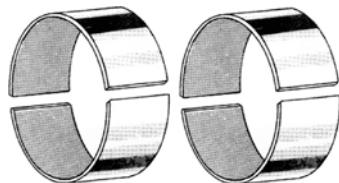

Art./Ref.	Note/Notes	Brand	Applicazione/Application	Rif. Orig./Orig. Ref.
<b>21686</b>	0,010 mm	<b>FORD</b>	5000, 5600, 5700, 6600, 6700, 8160, 8260, 8360	
<b>41416</b>	0,010 mm		7810S, 7840, 8010, 8160, 8240, 8260, 8340, 8360, 8560	87790262, 87790267
<b>40026B</b>	0,020 mm	<b>LANDINI</b>	4000/DT, 4000R, 4000S, 4500R, 5000/DT, 5000/N, 5000/S, 5000R, 5500, 5830, 5840, 5860, 5870, 6040, 6060, 6070, 6830, ADVANTAGE CAB E FOOT STEP :60, ADVANTAGE CAB E FOOT STEP: 55, BLIZZARD :60, BLIZZARD:50, CINGOLATI:C4500, CINGOLATI:C5000, CINGOLATI:C5500, CINGOLATI:C5830, CINGOLATI:CF4830, CINGOLATI:CF5030, CINGOLATI:CF5830, CINGOLATI:CF6030, CINGOLATI:CF6060, FRUTTETI 530 F/L/V:6030, FRUTTETI 530/F/L/V: 5530, FRUTTETI 530/F/L/V:4530, FRUTTETI 560F/L/V: 5560, FRUTTETI 560F/L/V:4560, FRUTTETI 560F/L/V:6060, GLOBUS:50, TREKKER :CF55, TREKKER :CF60, VIGNETI CAB E FOOT STEP :55V, VIGNETI CAB E FOOT STEP :60V	
<b>40035B</b>	0,020 mm		6000/DT, 6000/S, 6000R, 7000R, APPLICAZIONI DIVERSE, C6000	85035B
<b>40035C</b>	0,030 mm		6000/DT, 6000/S, 6000R, 7000R, APPLICAZIONI DIVERSE, C6000	85035B
<b>40036A</b>	0,030" Motore 4CYL:4.192-4.203/		6000/DT, 6000/S, 6000R, 7000R, APPLICAZIONI DIVERSE, C6000	68082A
<b>40036B</b>			6000/DT, 6000/S, 6000R, 7000R, APPLICAZIONI DIVERSE, C6000	68082B
<b>40036D</b>	0,040 mm		6000/DT, 6000/S, 6000R, 7000R, APPLICAZIONI DIVERSE, C6000	68082D
<b>40037A</b>	0,010 mm		6500, 6550, 6830, 6840, 6860, 6870, 6880, 7000 SPECIAL, 7000/DT, 7000R, 7500, 7550, 7830, 7860, 7870, 7880, 8000/DT, 8000R, 8500, 8550, 8830, 8860, 8870, 8880, 9060, 9080, 9880, ADVANTAGE CAB :L95, ADVANTAGE CAB E F.S. : 75, ADVANTAGE CAB E F.S. :65, ADVANTAGE CAB E F.S.:85, ATLAS : 85, ATLAS :75, BLIZZARD : 75, BLIZZARD :65, BLIZZARD :85, BLIZZARD:95, CINGOLATI : C6830, CINGOLATI :C6500, CINGOLATI :C7800, CINGOLATI :C7830, CINGOLATI :C8860, CINGOLATI :CF6830, FRUTTETI 530F/L/V: 7530, FRUTTETI 530F/L/V:6530, FRUTTETI 530F/L/V:8530, FRUTTETI 560/F/L/V: 7560, FRUTTETI 560/F/L/V:6560, FRUTTETI 560F/L/V:8560, NEW SERIE 60: 8860, NEW SERIE 60:7860, TREKKER : CF75, TREKKER :C75, TREKKER :C85, TREKKER :CF65, TREKKER :CF70, TREKKER :CF85, TREKKER:C 95, VIGNETI CAB E F.S. : 65V, VIGNETI CAB E F.S. :75V, VISION:80	85042A
<b>40037B</b>	0,020 mm		6500, 6550, 6830, 6840, 6860, 6870, 6880, 7000 SPECIAL, 7000/DT, 7000R, 7500, 7550, 7830, 7860, 7870, 7880, 8000/DT, 8000R, 8500, 8550, 8830, 8860, 8870, 8880, 9060, 9080, 9880, ADVANTAGE CAB :L95, ADVANTAGE CAB E F.S. : 75, ADVANTAGE CAB E F.S. :65, ADVANTAGE CAB E F.S.:85, ATLAS : 85, ATLAS :75, BLIZZARD : 75, BLIZZARD :65, BLIZZARD :85, BLIZZARD:95, CINGOLATI : C6830, CINGOLATI :C6500, CINGOLATI :C7800, CINGOLATI :C7830, CINGOLATI :C8860, CINGOLATI :CF6830, FRUTTETI 530F/L/V: 7530, FRUTTETI 530F/L/V:6530, FRUTTETI 530F/L/V:8530, FRUTTETI 560/F/L/V: 7560, FRUTTETI 560/F/L/V:6560, FRUTTETI 560F/L/V:8560, NEW SERIE 60: 8860, NEW SERIE 60:7860, TREKKER : CF75, TREKKER :C75, TREKKER :C85, TREKKER :CF65, TREKKER :CF70, TREKKER :CF85, TREKKER:C 95, VIGNETI CAB E F.S. : 65V, VIGNETI CAB E F.S. :75V, VISION:80	85042B
<b>40037C</b>	0,030 mm		6500, 6550, 6830, 6840, 6860, 6870, 6880, 7000 SPECIAL, 7000/DT, 7000R, 7500, 7550, 7830, 7860, 7870, 7880, 8000/DT, 8000R, 8500, 8550, 8830, 8860, 8870, 8880, 9060, 9080, 9880, ADVANTAGE CAB :L95, ADVANTAGE CAB E F.S. : 75, ADVANTAGE CAB E F.S. :65, ADVANTAGE CAB E F.S.:85, ATLAS : 85, ATLAS :75, BLIZZARD : 75, BLIZZARD :65, BLIZZARD :85, BLIZZARD:95, CINGOLATI : C6830, CINGOLATI :C6500, CINGOLATI :C7800, CINGOLATI :C7830, CINGOLATI :C8860, CINGOLATI :CF6830, FRUTTETI 530F/L/V: 7530, FRUTTETI 530F/L/V:6530, FRUTTETI 530F/L/V:8530, FRUTTETI 560/F/L/V: 7560, FRUTTETI 560/F/L/V:6560, FRUTTETI 560F/L/V:8560, NEW SERIE 60: 8860, NEW SERIE 60:7860, TREKKER : CF75, TREKKER :C75, TREKKER :C85, TREKKER :CF65, TREKKER :CF70, TREKKER :CF85, TREKKER:C 95, VIGNETI CAB E F.S. : 65V, VIGNETI CAB E F.S. :75V, VISION:80	85042C
<b>40037D</b>	0,040 mm		6500, 6550, 6830, 6840, 6860, 6870, 6880, 7000 SPECIAL, 7000/DT, 7000R, 7500, 7550, 7830, 7860, 7870, 7880, 8000/DT, 8000R, 8500, 8550, 8830, 8860, 8870, 8880, 9060, 9080, 9880, ADVANTAGE CAB :L95, ADVANTAGE CAB E F.S. : 75, ADVANTAGE CAB E F.S. :65, ADVANTAGE CAB E F.S.:85, ATLAS : 85, ATLAS :75, BLIZZARD : 75, BLIZZARD :65, BLIZZARD :85, BLIZZARD:95, CINGOLATI : C6830, CINGOLATI :C6500, CINGOLATI :C7800, CINGOLATI :C7830, CINGOLATI :C8860, CINGOLATI :CF6830, FRUTTETI 530F/L/V: 7530, FRUTTETI 530F/L/V:6530, FRUTTETI 530F/L/V:8530, FRUTTETI 560/F/L/V: 7560, FRUTTETI 560/F/L/V:6560, FRUTTETI 560F/L/V:8560, NEW SERIE 60: 8860, NEW SERIE 60:7860, TREKKER : CF75, TREKKER :C75, TREKKER :C85, TREKKER :CF65, TREKKER :CF70, TREKKER :CF85, TREKKER:C 95, VIGNETI CAB E F.S. : 65V, VIGNETI CAB E F.S. :75V, VISION:80	85042B

Art./Ref.	Note/Notes	Brand	Applicazione/Application	Rif. Orig./ Orig. Ref.	
<b>40038A</b>	0,010 mm	<b>LANDINI</b>	6060, 6070, 6500, 6550, 6830, 6840, 6860, 6870, 6880, 7000 SPECIAL, 7000/DT, 7000R, 7500, 7550, 7830, 7860, 7870, 7880, 8000/DT, 8000R, 8500, 8550, 8830, 8860, 8870, 8880, 9060, 9080, 9880, ADVANTAGE CAB :L95, ADVANTAGE CAB E F.S. : 75, ADVANTAGE CAB E F.S. :65, ADVANTAGE CAB E F.S.:85, ADVANTAGE CAB E FOOT STEP :60, ATLAS 80, ATLAS : 85, ATLAS :75, ATLAS: 100, ATLAS:70, ATLAS:90, BLIZZARD : 75, BLIZZARD :60, BLIZZARD :65, BLIZZARD :85, BLIZZARD:95, CINGOLATI : C6830, CINGOLATI :C6500, CINGOLATI :C7800, CINGOLATI :C7830, CINGOLATI :C8860, CINGOLATI :CF6830, CINGOLATI:CF6060, FRUTTETI 530F/L/V: 7530, FRUTTETI 530F/L/V:6530, FRUTTETI 530F/L/V:8530, FRUTTETI 560F/L/V: 7560, FRUTTETI 560F/L/V:6560, FRUTTETI 560F/L/V:6060, FRUTTETI 560F/L/V:8560, GHIBLI: 100, GHIBLI:80, GHIBLI:90, GLOBUS : 80, GLOBUS :75, GLOBUS:65, MYTHOS: 100, MYTHOS:90, NEW SERIE 60: 8860, NEW SERIE 60:6860, NEW SERIE 60:7860, NEW TREKKER : 100C, NEW TREKKER :70C/F/L, NEW TREKKER :90C/F/L, NEW TREKKER: 80C/F/L, REX CAB E F.S. :70, REX CAB E F.S.:80, REX CAB E F.S: 90, TREKKER : CF75, TREKKER :C75, TREKKER :C85, TREKKER :CF60, TREKKER :CF65, TREKKER :CF70, TREKKER :CF85, TREKKER:C 95, VIGNETI CAB E F.S : 65V, VIGNETI CAB E F.S : 75V, VIGNETI CAB E FOOT STEP :60V, VIGNETI REX CAB :70V, VIGNETI REX CAB :80V, VISION : 100, VISION :90, VISION:80	81558A, U5MB0008C	
<b>40038B</b>	0,020 mm		7000 SPECIAL, 7000/DT, 7000R, 8000/DT, 8000R, 8500, 8550, 8830, 8860, 8870, 8880, 9060, 9080, 9880, ADVANTAGE CAB :L95, ADVANTAGE CAB E F.S.:85, ATLAS 80, ATLAS : 85, ATLAS :75, ATLAS: 100, ATLAS:70, ATLAS:90, BLIZZARD :85, BLIZZARD:95, CINGOLATI :C7800, CINGOLATI :C7830, CINGOLATI :C8860, FRUTTETI 530F/L/V:8530, FRUTTETI 560F/L/V:8560, GHIBLI: 100, GHIBLI:80, GHIBLI:90, GLOBUS : 80, GLOBUS :75, GLOBUS:65, MYTHOS: 100, MYTHOS:90, NEW SERIE 60: 8860, NEW SERIE 60:6860, NEW SERIE 60:7860, NEW TREKKER : 100C, NEW TREKKER :70C/F/L, NEW TREKKER :90C/F/L, NEW TREKKER: 80C/F/L, REX CAB E F.S. :70, REX CAB E F.S.:80, REX CAB E F.S: 100, REX CAB E F.S: 90, TREKKER :C85, TREKKER :CF85, TREKKER:C 95, VIGNETI REX CAB :70V, VIGNETI REX CAB :80V, VISION : 100, VISION :90, VISION:80	81558B	
<b>40038C</b>	0,030 mm		7000 SPECIAL, 7000/DT, 7000R, 8000/DT, 8000R, 8500, 8550, 8830, 8860, 8870, 8880, 9060, 9080, 9880, ADVANTAGE CAB :L95, ADVANTAGE CAB E F.S.:85, ATLAS 80, ATLAS : 85, ATLAS :75, ATLAS: 100, ATLAS:70, ATLAS:90, BLIZZARD :85, BLIZZARD:95, CINGOLATI :C7800, CINGOLATI :C7830, CINGOLATI :C8860, FRUTTETI 530F/L/V:8530, FRUTTETI 560F/L/V:8560, GHIBLI: 100, GHIBLI:80, GHIBLI:90, GLOBUS : 80, GLOBUS :75, GLOBUS:65, MYTHOS: 100, MYTHOS:90, NEW SERIE 60: 8860, NEW SERIE 60:6860, NEW SERIE 60:7860, NEW TREKKER : 100C, NEW TREKKER :70C/F/L, NEW TREKKER :90C/F/L, NEW TREKKER: 80C/F/L, REX CAB E F.S. :70, REX CAB E F.S.:80, REX CAB E F.S: 100, REX CAB E F.S: 90, TREKKER :C85, TREKKER :CF85, TREKKER:C 95, VIGNETI REX CAB :70V, VIGNETI REX CAB :80V, VISION : 100, VISION :90, VISION:80	81558C	
<b>40038D</b>	0,040 mm		6500, 6550, 6830, 6840, 6860, 6870, 6880, 7000 SPECIAL, 7000/DT, 7000R, 7500, 7550, 7830, 7860, 7870, 7880, 8000/DT, 8000R, 8500, 8550, 8830, 8860, 8870, 8880, 9060, 9080, 9880, ADVANTAGE CAB :L95, ADVANTAGE CAB E F.S. : 75, ADVANTAGE CAB E F.S. :65, ADVANTAGE CAB E F.S.:85, ATLAS 80, ATLAS : 85, ATLAS :75, ATLAS: 100, ATLAS:70, ATLAS:90, BLIZZARD : 75, BLIZZARD :65, BLIZZARD :85, BLIZZARD:95, CINGOLATI : C6830, CINGOLATI :C6500, CINGOLATI :C7800, CINGOLATI :C7830, CINGOLATI :C8860, CINGOLATI :CF6830, FRUTTETI 530F/L/V: 7530, FRUTTETI 530F/L/V:6530, FRUTTETI 530F/L/V:8530, FRUTTETI 560F/L/V: 7560, FRUTTETI 560F/L/V:6560, FRUTTETI 560F/L/V:8560, GHIBLI: 100, GHIBLI:80, GHIBLI:90, GLOBUS : 80, GLOBUS :75, GLOBUS:65, MYTHOS: 100, MYTHOS:90, NEW SERIE 60: 8860, NEW SERIE 60:6860, NEW SERIE 60:7860, NEW TREKKER : 100C, NEW TREKKER :70C/F/L, NEW TREKKER :90C/F/L, NEW TREKKER: 80C/F/L, REX CAB E F.S. :70, REX CAB E F.S.:80, REX CAB E F.S: 100, REX CAB E F.S: 90, TREKKER : CF75, TREKKER :C75, TREKKER :C85, TREKKER :CF65, TREKKER :CF70, TREKKER :CF85, TREKKER:C 95, VIGNETI CAB E F.S : 65V, VIGNETI CAB E F.S : 75V, VIGNETI REX CAB :70V, VIGNETI REX CAB :80V, VISION : 100, VISION :90, VISION:80		
<b>40043A</b>	0,010 mm			10000, 10000S, 12500, 13000, 9500, LEGEND 105, LEGEND 115, LEGEND N/G:115	85043A
<b>40045C</b>	0,030 mm			14500, 16500, C10500, LEGEND: 115, MYTHOS NEW TIER 2:115	
<b>40038</b>	0,030" Motore 3CYL:T3.152.4			6500, 6550, 6830, 6840, 6860, 6870, 6880, 7000 SPECIAL, 7000/DT, 7000R, 7500, 7550, 7830, 7860, 7870, 7880, 8000/DT, 8000R, 8500, 8550, 8830, 8860, 8870, 8880, 9060, 9080, 9880, ADVANTAGE CAB :L95, ADVANTAGE CAB E F.S. : 75, ADVANTAGE CAB E F.S. :65, ADVANTAGE CAB E F.S.:85, ATLAS 80, ATLAS : 85, ATLAS :75, ATLAS: 100, ATLAS:70, ATLAS:90, BLIZZARD : 75, BLIZZARD :65, BLIZZARD :85, BLIZZARD:95, CINGOLATI : C6830, CINGOLATI :C6500, CINGOLATI :C7800, CINGOLATI :C7830, CINGOLATI :C8860, CINGOLATI :CF6830, FRUTTETI 530F/L/V: 7530, FRUTTETI 530F/L/V:6530, FRUTTETI 530F/L/V:8530, FRUTTETI 560F/L/V: 7560, FRUTTETI 560F/L/V:6560, FRUTTETI 560F/L/V:8560, GHIBLI: 100, GHIBLI:80, GHIBLI:90, GLOBUS : 80, GLOBUS :75, GLOBUS:65, MYTHOS: 100, MYTHOS:90, NEW SERIE 60: 8860, NEW SERIE 60:6860, NEW SERIE 60:7860, NEW TREKKER : 100C, NEW TREKKER :70C/F/L, NEW TREKKER :90C/F/L, NEW TREKKER: 80C/F/L, REX CAB E F.S. :70, REX CAB E F.S.:80, REX CAB E F.S: 100, REX CAB E F.S: 90, TREKKER : CF75, TREKKER :C75, TREKKER :C85, TREKKER :CF65, TREKKER :CF70, TREKKER :CF85, TREKKER:C 95, VIGNETI CAB E F.S : 65V, VIGNETI CAB E F.S : 75V, VIGNETI REX CAB :70V, VIGNETI REX CAB :80V, VISION : 100, VISION :90, VISION:80	735168M91
<b>40026C</b>	0,020" Motore 3CYL:A3.152			4000/DT, 4000R, 4000S, 4500R, 5000/DT, 5000/N, 5000/S, 5000R, 5500, 5830, 5840, 5860, 5870, 6040, 6060, 6070, 6830, ADVANTAGE CAB E FOOT STEP :60, ADVANTAGE CAB E FOOT STEP: 55, BLIZZARD :60, BLIZZARD:50, CINGOLATI:C4500, CINGOLATI:C5000, CINGOLATI:C5500, CINGOLATI:C5830, CINGOLATI:CF4830, CINGOLATI:CF5030, CINGOLATI:CF5830, CINGOLATI:CF6030, CINGOLATI:CF6060, FRUTTETI 530 F/L/V:6030, FRUTTETI 530F/L/V: 5530, FRUTTETI 530F/L/V:4530, FRUTTETI 560F/L/V: 5560, FRUTTETI 560F/L/V:4560, FRUTTETI 560F/L/V:6060, GLOBUS:50, TREKKER :CF55, TREKKER :CF60, VIGNETI CAB E FOOT STEP :55V, VIGNETI CAB E FOOT STEP :60V	
<b>40036C</b>				6000/DT, 6000/S, 6000R, 7000R, APPLICAZIONI DIVERSE, C6000	68082A
<b>40025B</b>	0,020 mm			4000/DT, 4000R, 4000S, 4500R, 5000/DT, 5000/N, 5000/S, 5000R, 5500, 5830, 5840, 5860, 5870, 6040, 6830, ADVANTAGE CAB E FOOT STEP: 55, BLIZZARD:50, CINGOLATI:C4500, CINGOLATI:C5000, CINGOLATI:C5500, CINGOLATI:C5830, CINGOLATI:CF4830, CINGOLATI:CF5030, CINGOLATI:CF5830, CINGOLATI:CF6030, FRUTTETI 530 F/L/V:6030, FRUTTETI 530F/L/V: 5530, FRUTTETI 530F/L/V:4530, FRUTTETI 560F/L/V: 5560, FRUTTETI 560F/L/V:4560, GLOBUS :55, GLOBUS:50, NEW SERIE 60:5860, REX CAB E F.S :60, TREKKER :CF55, VIGNETI CAB E FOOT STEP :55V, VIGNETI REX CAB :60V	85036B
<b>40033A</b>	0,010 mm	<b>PERKINS</b>		84992A	

**KIT SEGMENTI ADATTABILI**

KITS DE SEGMENT ADAPTABLE

SEGMENT KITS ADAPTABLE

SEGMENT-KITS PASSEND ZU

KITS DE SEGMENTOS ADAPTABLE



Art./Ref.	Note/Notes	Brand	Applicazione/Application	Rif. Orig./Orig. Ref.
21673	STD = alesaggio 111,76/STD = alesaggio 111,76	FORD	3230, 3430, 3610, 3919, 3930, 4000, 4600, 4610, 4630, 4610H, 4130H, 4830, 5030, 5110, 5610, 5710, 5000, 5600, 5110, 5610, 5900, 550, 555, 555A/B, 3930H, 6410, 6610, 6710, 655C, 655D, 6600, 670, 655M, 655A, 6600, 6700, 6410, 6610, 6710, 7810, 7910, 8210, 8000, 8530, TW5	83917468
41500	STD = alesaggio 111,76		8630, 8730, 8830, 9700, 9000, 6810, 7410, 7610, 7710, 7810,, 7000, 7600, 7700, 7610, 7710, 7910, 8210, 8000, 8600, 8700, 9200, 9600, TW 15/20/25, TW 30/35, TW5, TW10	83905823
40113	STD = alesaggio 88,92/STD = alesaggio 88,92			81717647
21673C	0,76 mm			83917470, DJPN6149Y
21669C	0,76 mm			83917466, DJPN6149U
21673D	1,02 mm			83917471, DJPN6149Z
21669B				DJPN6149S
40091		LANDINI	5500, 5830, 5840, 5860, 5870, ADVANTAGE CAB E FOOT STEP:55, BLIZZARD:50, CINGOLATI : CF5030, CINGOLATI : CF5830, CINGOLATI :C5500, CINGOLATI :C5830, FRUTTETI 530:5530L/V, FRUTTETI 560: 5560F, FRUTTETI 560:4560V, FRUTTETI 560:5560L, GLOBUS :50, TREKKER :CF55, VIGNETI CAB E FOOT STEP:55V	745826M91
40093			6030, 6040, 6060, 6070, ADVANTAGE CAB E FOOT STEP:60, BLIZZARD :60, CINGOLATI :CF6030, CINGOLATI:CF6060, FRUTTETI 530F/L/V:6030, FRUTTETI 560F/L/V:6060, TREKKER :CF60, VIGNETI CAB E FOOT STEP :60V	3638235M91
40123			10000, 6500, 6550, 6830, 6840, 6860, 6870, 6880, 7500, 7550, 7830, 7860, 7870, 7880, 9500, ADVANTAGE CAB E F.S : 75, ADVANTAGE CAB E F.S :65, BLIZZARD : 75, BLIZZARD :65, C10500, C6500, CINGOLATI: CF6830, CINGOLATI:C6830, FRUTTETI 530F/L/V: 7530, FRUTTETI 530F/L/V:6530, FRUTTETI 560F/L/V: 7560, FRUTTETI 560F/L/V:6560, TREKKER : CF65, TREKKER : CF70, TREKKER : CF75, TREKKER :C75, VIGNETI CAB E F.S. : 75V, VIGNETI CAB E F.S. :65V	41158041, 745760M91
40084		MASSEY FERGUSON	2685, 2720, 2725, 35, 65, 765, 155, 158, 165,	3033243M3, 41158058, 745819M91
40097			168, 175, 1100, 2620, 2625,, APPLICAZIONI INDUSTRIALI	41158041C
40162R			1105, 1130, 1135	41158031, 745751M91
40141			285, 295, 1080, 1085	745950M91
40155				745752M91
40292			TEF 20 4 CIL. 20C	
40131			3650, 698T, 3065	41158005, 745277M91



**LEVE ORIGINALI E ADATTABILI**

LEVIER ORIGINAL ET ADAPTABLE  
LEVERS ORIGINAL AND ADAPTABLE  
HEBEL ORIGINAL UND PASSEND ZU  
PALANCAS ORIGINAL Y ADAPTABLE



Art./Ref.	Descrizione estesa/Extended Description	Tipo/Type	Brand	Rif. Orig./Orig. Ref.
19280	Leva di comando adattabile a rif. orig. Fiat 5152537	Adattabile	FIAT	5152537
26751	Tirante per distributore adattabile a rif. orig. Fiat 5151505	Adattabile		5151505
26752	Tirante per distributore adattabile a rif. orig. Fiat 5146463	Adattabile		5146463
26754	Tirante per distributore adattabile a rif. orig. Fiat 5151506	Adattabile		5151506
26755	Leva adattabile a rif. Orig. Fiat 5155729	Adattabile		5155729
27619	Leva innesto adattabile a rif. Orig. Fiat 5107195	Adattabile		5107195
29023	Tirante / leva freno adattabile a rif. orig. Fiat 5131549	Adattabile		5131549
N0587191	Tirante adattabile a rif. Orig. Fiat 587191	Adattabile		587191
N04996591	Leva cambio adattabile a rif. Orig. Fiat 4996591	Adattabile		4996591
N04973658	Leva adattabile a rif. Orig. Fiat 4973658	Adattabile		4973658
N05119733	Tirante sinistro per 3° punto adattabile a rif. orig. Fiat 5119733	Adattabile		5119733
N05171290	Tirante stabilizzatore adattabile a rif. orig. Fiat 5171290	Adattabile	5171290	
V0.177.6552.6/1	Leva di comando frizione originale Same rif. 0.177.6552.6/10	Originale	SAME	0.177.6552.6/10
V0.9104.721.4	Gruppo leva originale Same rif. 0.9104.721.4	Originale		0.9104.721.4
V0.9124.325.3	Leva di sollevamento originale Same rif. 0.9124.325.3	Originale		0.9124.325.3

**MOLLE ADATTABILI E ORIGINALI**

PRINTEMPS ORIGINAL ET ADAPTABLE  
SPRINGS ORIGINAL AND ADAPTABLE  
DRUCKFEDERN ORIGINAL UND PASSEND ZU  
MUELLES ORIGINAL Y ADAPTABLE



Art./Ref.	Descrizione estesa/Extended Description	Tipo/Type	Brand	Applicazione/Application	Rif. Orig./Orig. Ref.
15365	Molla adattabile a rif. orig. Fiat 567861	Adattabile	FIAT	640, 65.46DT	567861
28108	Molla valvole adattabile a rif. orig. Fiat 4798427	Adattabile		100C, 120C, 1300, 1300S, 650, 655, 655C	4798427, 8818954
27576	Molla a gas per cofano e plancia adattabile a rif. orig. Fiat 5163729	Adattabile		45.66-50.66-45.66 S-50.66 S	5162265, 5163729
19105	Molla tirante flessibile per comando disinnesto frizione adattabile a rif. orig. Fiat 5102752	Adattabile		115.90-130.90-140.90, 1180-1280-1380-1580-1880, 780, 880	5102752
14381	Molla adattabile a rif. Orig. Fiat 5107266	Adattabile			5107266
19106	Molla adattabile a rif. orig. Fiat 5108410	Adattabile			5108410
26158	Molla tipo adattabile a rif. orig. Fiat 4951027	Adattabile			4951027
15289	Molla adattabile a rif. orig. Fiat 550457	Adattabile			550457
15372	Molla adattabile a rif. orig. Fiat 563587	Adattabile			563587, 585376
15529	Molla adattabile a rif. Orig. Fiat 5108239	Adattabile			5108239
27611	Molla trazione adattabile a rif. Orig. Fiat 5129033	Adattabile			5129033
27613	Molla adattabile a rif. orig. Fiat 5118181	Adattabile			5118181, 541053
12940R	Molla balestra adattabile a rif. orig. Fiat 576452	Adattabile			576452
12944R	Molla a balestra adattabile a rif. orig. Fiat 4950505	Adattabile			4950505
40267R	Molla seterna per testata motore adattabile a rif. orig. Massey Ferguson 0780272	Adattabile		PERKINS	0780272
V2.4019.154.1	Molla originale Same rif. 2.4019.154.1	Originale	SAME		2.4019.154.1
V2.4049.139.1/1	Molla originale Same rif. 2.4049.139.1/10	Originale			2.4049.139.1/10

**PERNI ADATTABILI E ORIGINALI**

PINS ADAPTABLE ET ORIGINAL  
 PINS ADAPTABLE AND ORIGINAL  
 PINS ANPASSBARE UND ORIGINAL  
 PINES ADAPTABLES Y ORIGINALES



Art./Ref.	Descrizione estesa/Extended Description	Tipo/Type	Brand	Applicazione/Application	Rif. Orig./Orig. Ref.
27700	Perno adattabile a rif. Orig. Fiat 4966278	Adattabile	FIAT		4966278
27659	Perno cilindro adattabile a rif. orig. Fiat 4956706	Adattabile		4956706, 4964485, 4968787	
28509	Perno adattabile a rif. orig. Fiat 4996898	Adattabile		4996898	
16421	Perno satellite adattabile a rif. orig. Fiat 567875	Adattabile		567875	
27526	Perno adattabile a rif. orig. Fiat 82010147	Adattabile		82010147	
27816	Perno cilindro adattabile a rif. orig. Fiat 5101297	Adattabile		5101297	
27817	Perno per comando disinnesto frizione adattabile a rif. orig. Fiat 5110834	Adattabile		1180-1280-1380-1580-1880-115.9, 130.90-140.90, 130.90-140.90-160.90-180.90	5110834
27704	Perno adattabile a rif. orig. Fiat 5132286	Adattabile		5132286	
27527	Perno adattabile a rif. Orig. Fiat 5162713	Adattabile		5162713, 82007955, 82010148, 82014744	
28519R	Perno adattabile a rif. Orig. Fiat 5123642	Adattabile		5123642	
27967	Perno adattabile a rif. Orig. Fiat 5158870	Adattabile		5158870	
15508	Perno adattabile a rif. Orig. Fiat 5102288	Adattabile		5102288	
29831	Perno di fissaggio adattabile a rif. orig. Fiat 5127012	Adattabile		5127012	
27702	Perno supporto e barra di torsione per dispositivo attacco atrezzi, adattabile a rif. orig. Fiat 5109172	Adattabile		115.90-130.90-140.90-160.90-18, 1180, 1280, 1380, 1580, 1580T, 1880, 115-90, 45.66S, 50.66S, 56.66S, 55.76F, 55.66, 60.66, 60.90, 60.93, 55.86F, 60.86F, 70.86F, 60.94, 65.66, 65.88, 65.90, 65.93-65.94-70.66-70.90, 72.93-72.94-80.66-80.90, 82.93-82.94-85.90-88.93-88.94, 90.90-100.90-110.90, L60-L65, TD55D-TD65D-TD75D-TD85D-TD95D, TL70-TL80-TL90-TL100, TN65F, TN75F, TN90F	5109172
28091	Perno adattabile a rif. Orig. Fiat 5173020	Adattabile		5173020	
15236	Perno adattabile rif. orig. Fiat 5152963	Adattabile		880-5, 980, 90.90	4993572, 5144468, 5152963
27528	Perno adattabile a rif. Orig. Fiat 82010162	Adattabile		82010162, 82016898	
29909	Perno pedale adattabile a rif. orig. Fiat 44013367	Adattabile		44013367	
28101	Perno adattabile a rif. orig. Fiat 5177556	Adattabile		5177556	
27961	Perno adattabile a rif. Orig. Fiat 4766736	Adattabile		4766736	
16452	Perno adattabile a rif. orig. Fiat 5011869	Adattabile		5011869, 557070	
14639	Perno per ponte anteriore adattabile a rif. orig. Fiat 4998021	Adattabile		1180, 1280, 1380, 1580, 1880, 850DTS, 1000DTS, 1300DTS, 90.90DT, 100.90DT, 110.90DT	4998021
27701	Perno satellite adattabile a rif. Orig. 4991970	Adattabile		4991970	
27518	Perno giunto sferico adattabile a rif. orig. Fiat 5137138	Adattabile	5137138		
17032	Perno adattabile a rif. orig. Fiat 4997697	Adattabile	90.90DT, 100.90DT, 110.90DT	4997697	
28092	Perno adattabile a rif. Orig. Fiat 5159486	Adattabile	5159486		
26903	Grano centrale adattabile a rif. orig. Fiat 596828	Adattabile	596828		
29114	Perno adattabile a rif. orig. Laverda 300129071	Adattabile	LAVERDA	300129071	
V2.1699.281.2/1	Perno sferico originale Same rif. 2.1699.281.2/10	Originale	SAME	2.1699.281.2/10	

**PISTONI ADATTABILI E ORIGINALI**

PISTONS ADAPTABLES ET ORIGINAUX  
 PISTONS ADAPTABLE AND ORIGINAL  
 KOLBEN ADAPTABLE UND ORIGINAL  
 PISTONES ADAPTABLES Y ORIGINALES



Art./Ref.	Note/Notes	Tipo/Type	Brand	Applicazione/Application	Rif. Orig./Orig. Ref.	
<b>28267</b>	STD	Adattabile	<b>FIAT</b>	100.90-F100, 45.66-55.46-55.66LP-55.90, 65.46-65.66-70.65-70.66-70, 70.66LP-70.90-72.93, L65, TL70	1930241	
<b>41482R</b>		Adattabile			83910855	
<b>41483</b>	STD = 111,76	Adattabile	<b>FORD</b>		83928178, E0NN6108AA	
<b>41479</b>	STD = 111,76	Adattabile			81846014, D4NN6108AA	
<b>41494</b>	STD = 111,76	Adattabile		6410, 6610, 6710, 655C, 655D	83960625, E7NN610FA	
<b>41502</b>	STD = 111,76	Adattabile		7810, 7910, 8210, 8000, 8600, 8700, TW 5, TW 10	83905772, D5NN6108S	
<b>41501</b>	STD = 111,76	Adattabile		6810, 7410, 7610, 7710	83960635, E7NN6108LA	
<b>41492</b>	STD = 111,76	Adattabile		4830, 5030, 5110, 5610, 5710	83960615, E7NN6108AA	
<b>41493</b>	STD = 111,76	Adattabile		7000, 7600, 7700	83912026, D6NN6108Y	
<b>40112</b>	STD = 88,92	Adattabile			81803864	
<b>41495</b>	STD = 111,76	Adattabile		5640, 7810S, 7840	81873439, F0NN6108AB	
<b>41503</b>	STD = 111,76	Adattabile		TW 15 / 20 / 25 / 30 / 35	83913727, D7NN6108A	
<b>41498</b>	STD = 111,76	Adattabile		6640, TS 80, 90, 115, 8240, 8340	81873448, F0NN6108FB	
<b>41499R</b>		Adattabile			83919735, D9NN6108FA	
<b>43047R</b>		Adattabile			83910850, D6NN6108L	
<b>40128</b>		Adattabile		<b>LANDINI</b>	9060, 9080, 9880, ADVANTAGE CAB :L95, BLIZZARD:95, TREKKER:C 95	
<b>40136</b>		Adattabile			8000/DT, 8000R, 8500, 8550, 8830, 8860, 8870, 8880, ADVANTAGE CAB E F.S.:85, BLIZZARD :85, CINGOLATI :C7800, CINGOLATI :C7830, CINGOLATI :C8860, FRUTTETI 530F/L/V:8530, FRUTTETI 560F/L/V:8560, TREKKER :C85, TREKKER :CF85	
<b>40163</b>		Adattabile	14500, 16000, 16500			
<b>41664</b>	Versione con anelli in nylon/Versione con anelli in nylon/Versione con anelli in nylon/Versione con anelli in nylon/Versione con anelli in nylon	Adattabile	<b>MASSEY FERGUSON</b>		1693921M3	
<b>40132</b>		Adattabile			3637360M91	
<b>40122</b>		Adattabile			735187M91	
<b>40090</b>		Adattabile			742621M91	
<b>40144</b>		Adattabile			746231M91	
<b>40160</b>		Adattabile			747541M91	
<b>40103</b>		Adattabile			1884101M91	
<b>40159</b>		Adattabile			748266M91	
<b>41663A</b>		Adattabile			1665738M91	
<b>40154R</b>		Adattabile			3637280M91	
<b>40157R</b>		Adattabile			748267M91	
<b>40559</b>		Adattabile		<b>PERKINS</b>	68306	
<b>40697R</b>		Adattabile			55274C	
<b>V0.073.0060.6</b>		Originale	<b>SAME</b>	0.073.0060.6		
<b>V0.099.0065.A</b>		Originale		0.099.0065.A		

**POMPE ORIGINALI E ADATTABILI**

POMPES ORIGINALES ET ADAPTABLES  
 PUMPS ORIGINAL AND ADAPTABLE  
 PUMPEN ORIGINAL UND ANPASSBARE  
 BOMBAS ORIGINALES Y ADAPTABLES

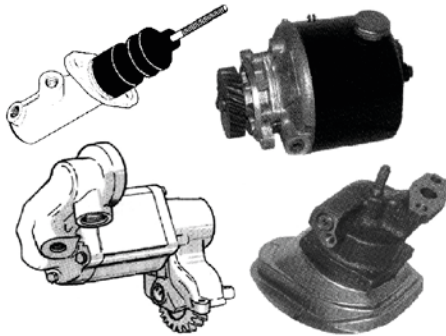

Art./Ref.	Note/Notes	Tipo/Type	Brand	Applicazione/Application	Rif. Orig./Orig. Ref.	
15131	Olio	Adattabile	FIAT		4614720, 4680169	
NH5177914	Idraulica	Originale	NEW HOLLAND		5177914	
NH82018664	Freni	Originale			82018664	
42686	Idraulica sterzo	Adattabile		8000, 9000, 8600, 9600, 8700, 9700, TW 5, 10, 15, TW, 20, 25	83924998, E0NN-3K514AB	
41551	Olio	Adattabile	FORD	5030, 6410, 6610, 6710, 6810, 7000, 7410, 7600, 7610, 7700, 7710	83956421, E1NN6600CC	
42687	Idraulica sterzo	Adattabile		8530, 8630, 8730, 8830, TW 30, 35	81871789, 83924997, D8NN3K514JC, D8NN3K514JD	
41553	Olio	Adattabile		7810S, 7840, 8010, 8160, 8240, 8340, 8360, 8560, 8670, 8770, 8870, 8970, TM 115, 125, 135, 150, 165, TS 115	81868538, E9NN6600BB	
42713	Idraulica	Adattabile		8000, 9000, 8200, 9200, 8600, 9600, 8700, 9700, TW 10, 20, 30 <31.12.78	83903943, D5NN600C	
42715R	Idraulica	Adattabile			83945584, E2N-N600AB	
LN2641A203	Idraulica	Originale		LANDINI		2641A203
LN3540971M91	Idraulica	Originale				3540971M91
LN4132F041	Olio	Originale			4132F041	
LN355394M91	Frizione	Originale			3555394M91	
41708	Idraulica sollevatore	Adattabile	12500, 14500, 16500		3540438M91, 3790722M1	
11282	Olio	Adattabile	6000/DT, 6000/S, 6000R, 7000R, APPLICAZIONI VARIE, C6000		1447483M91, 3637471M91, 3638633M91, 41314087, 41314164, 41314189	
40024	Olio	Adattabile	MASSEY FERGUSON			3132F051, 3640908M91
40311	Olio	Adattabile			1100, 1200	41314131, 739400M91
40130	Olio	Adattabile			4132F056, 422282M91	
41653R	Idraulica Sterzo	Adattabile		592, 595, 1080	1808294M2	
PK41314078	Olio	Originale	PERKINS		41314078	
PK41314189	Olio	Originale			41314189	
V2.4539.280.0	Idraulica	Originale	SAME		2.4539.280.0	
V0.010.0194.4/3	Olio	Originale			0.010.0194.4/30	
V2.4529.970.0	Idraulica	Originale			2.4529.970.0	
V2.4539.060.0	Idraulica	Originale			2.4539.060.0	
V0.009.9232.4	Freni	Originale			0.009.9232.4	
V2.4539.160.0	Idraulica	Originale			2.4539.160.0	
V2.4539.020.0	Idraulica	Originale			2.4539.020.0	
V2.4529.920.0	Idraulica	Originale			2.4529.920.0	

**RONDELLE ADATTABILI**

ARANDELAS ADAPTABLES  
WASHERS ADAPTABLE  
UNTERLEGSCHIEBEN PASSEND ZU  
LAVEUSES ADAPTABLES



Art./Ref.	Descrizione estesa/Extended Description	Brand	Applicazione/Application	Rif. Orig./Orig. Ref.	
<b>27505</b>	Rondella dentata Z 14 adattabile a rif. orig. Fiat 5122797	<b>FIAT</b>	L60, L65, L75, TL70, TL80, L85, L95, TL90, TL100	4996872, 5122797	
<b>27682</b>	Spessore adattabile a rif. orig. Fiat 4750809			4750809	
<b>28060</b>	O-ring adattabile a rif. orig. Fiat 5138955			5138955	
<b>28117</b>	Rondella di spinta adattabile a rif. orig. Fiat 5149127		M100, M115, M135	5149127	
<b>28170</b>	Rosetta adattabile a rif. orig. Fiat 5169085			5169085	
<b>27689</b>	Spessore di 3,27mm adattabile a rif. orig. Fiat 4750816			4742204, 4750816	
<b>28116</b>	Rondella di spinta adattabile a rif. orig. Fiat 5149239		M100, M115, M135	5149239	
<b>28210</b>	Rosetta piana adattabile a rif. orig. Fiat 44018768			44018768	
<b>27690</b>	Spessore 3,30mm adattabile a rif. orig. Fiat 4750817			4750817	
<b>28152</b>	Spessore adattabile a rif. orig. Fiat 5124475			5124475	
<b>27686</b>	Spessore 3,21mm adattabile a rif. orig. Fiat 4742201			4742201, 4750813	
<b>15235</b>	Ralla adattabile a rif. orig. Fiat 5153392			5153392	
<b>28131</b>	Ralla adattabile a rif. orig. Fiat 5145499			5145499	
<b>29917</b>	Rosetta adattabile a rif. orig. Fiat 5120026			5120026	
<b>28154</b>	Rosetta piana per mozzo ruota del ponte anteriore adattabile a rif. orig. Fiat 5100516			TL70-TL80-TL90-TL100, TN65F-TN70F-TN75F-TN80F, TN90F-TN95F	5100516
<b>28207</b>	Rosetta adattabile a rif. Orig. Fiat 11190771				11190771, 11190774
<b>29918</b>	Rosetta adattabile a rif. Orig. Fiat 595050				595050
<b>16609</b>	Distanziale adattabile a rif. orig. Fiat 5179421				5179421
<b>29169</b>	Distanziale adattabile a rif. Orig. Fiat 79059635				79059635
<b>27960</b>	Distanziale adattabile a rif. Orig. Fiat 4754647				4754647
<b>27955</b>	Distanziale adattabile a rif. Orig. Fiat 4711787			4711787	
<b>28409</b>	Distanziale per ponte anteriore adattabile a rif. orig. Fiat 5102121		1180, 1280, 1380, 1580, 1880	5102121	
<b>40039A</b>	Kit rasamenti adattabile a rif. orig. Massey Ferguson 31137312	<b>MASSEY FERGUSON</b>	8110, 8120	735742M1, 735743M1	
<b>40039</b>	Kit rasamenti adattabile a rif. orig. Massey Ferguson 31137551			747128M1, 747129M1	
<b>40951</b>	Rasamento adattabile a rif. Orig. Massey Ferguson 1866545M2		698T, 699	1866545M2	

**SCODELLINI ADATTABILI FIAT**

CASQUETTES ADAPTABLES FIAT  
CHOCKS ADAPTABLE FIAT  
KAPPEN PASSEND ZU FIAT  
TAPAS ADAPTABLES FIAT

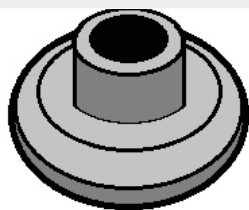

Art./Ref.	Descrizione estesa/Extended Description	Brand	Applicazione/Application	Rif. Orig./Orig. Ref.
<b>29171</b>	Scodellino per comando di distribuzione adattabile a rif. orig. Fiat 4601302	<b>FIAT</b>	250, 300, 300J, 420, 450, 450R, 470, 480/8, 640, 666, 670, 680, 600, 605C, 880.5, 955C	4601302
<b>15279</b>	Scodellino adattabile a rif. orig. Fiat 546599			546599
<b>26855</b>	Scodellino per comando distribuzione adattabile a rif. orig. Fiat 4578175			250-300-300J, 420-450-450R-470-480/8, 640-666-670-680-600-605C, 880.5-955C, 980-1000S-1180-1280-1380

**SUPPORTI ADATTABILI E ORIGINALI**

SUPPORTS ADAPTABLES ET ORIGINAUX  
ADAPTABLE AND ORIGINAL SUPPORTS  
STÜTZEN ANGEPASSTEN UND ORIGINAL  
SOPORTES ADAPTABLES Y ORIGINALES

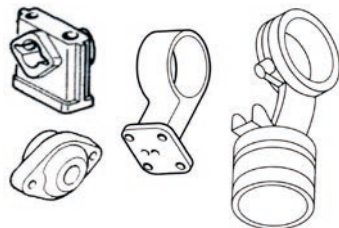

Art./Ref.	Descrizione estesa/Extended Description	Tipo/Type	Brand	Applicazione/Application	Rif. Orig./Orig. Ref.
26475	Supporto posteriore adattabile a rif. Orig. Fiat 5132306	Adattabile	FIAT	115.90-130.90-140.90-65.94, 55.88-55.90-60.88-60.90-60.94, 60.94-65.88-65.90-65.94-70.88, 70.88-80.88-70.90-80.90-85.90, 70.90-80.88-80.90, 72.94-82.94, 88.94, 85.90-90.90-100.90- 110.90	5132306
26474	"Supporto anteriore adattabile a rif. Orig. 5132305	Adattabile			5132305
29994	Supporto adattabile a rif. orig. Fiat 5148602	Adattabile			5148602
26482	Supporto parabrezza anteriore e lunotto posteriore adattabile a rif. orig. Fiat 5108653	Adattabile			5108653
26476R	Supporto anteriore adattabile a rif. Orig. Fiat 5121100	Adattabile			5121100
N0592573	Supporto rullo superiore adattabile a rif. orig. Fiat 592573	Adattabile			592573
N0599400	Supporto assale anteriore adattabile a rif. orig. Fiat 599400	Adattabile			599400
N0597412	Supporto puntone adattabile a rif. Orig. Fiat 597412	Adattabile			597412
N05124502	Supporto differenziale sinistro adattabile a rif. orig. Fiat 5124502	Adattabile			5124502
N05102103	Supporto differenziale completo adattabile a rif. orig. Fiat 5102103	Adattabile			5102103
N04986426	Supporto adattabile a rif. orig. Fiat 4986426	Adattabile	4986426		
NH5153903	Supporto leve originale Fiat rif. 5153903	Originale	NEW HOLLAND	5153903	
LN3531573M1	Supporto originale Landini rif. 3531573M1	Originale	LANDINI	3531573M1	
LN2733914M92	Supporto originale Landini rif. 2733914M92	Originale		2733914M92	
11877	Supporto assale anteriore adattabile a rif. Orig. Massey Ferguson 1870287M95	Adattabile	MASSEY FERGUSON	1870287M95	

**TAPPO ORIGINALE E ADATTABILE**

BUCHON ORIGINAL ET ADAPTABLE  
CAP ORIGINAL AND ADAPTABLE  
KRAFTSTOFFTANK ORIGINAL UND PASSEND ZU  
TAPON ORIGINAL YADAPTABLE



Art./Ref.	Descrizione estesa/Extended Description	Tipo/Type	Brand	Applicazione/Application	Rif. Orig./Orig. Ref.
27655	Tappo per testata sollevatore idraulico adattabile a rif. orig. Fiat 4999664	Adattabile	FIAT	640, 65.46DT	4999664
16469	Tappo adattabile a rif. orig. Fiat 5180946	Adattabile			5180946
21801	Tappo coppa adattabile rif. orig. Ford 81822147	Adattabile	FORD	2000, 3000, 3055, 4000, 5000, 7000	81822147, C9NN6730B
VO.012.3914.3	Tappo serbatoio originale Same rif. 0.012.3914.3	Originale	SAME		0.012.3914.3

**TUBI ORIGINALI E ADATTABILI FIAT / NEW HOLLAND**
*TUYAU ORIGINAL ET ADAPTABLE FIAT / NEW HOLLAND*
*HOSES ORIGINAL AND ADAPTABLE FIAT / NEW HOLLAND*
*ROHRE ORIGINAL UND PASSEND ZU FIAT / NEW HOLLAND*
*TUBOS ORIGINAL Y ADAPTABLE FIAT / NEW HOLLAND*

Art./Ref.	Descrizione estesa/Extended Description	Tipo/Type	Brand	Applicazione/Application	Rif. Orig./Orig. Ref.
<b>28232</b>	Tubo flessibile adattabile a rif. Orig. Fiat 4776650	Adattabile	<b>FIAT</b>	850S-1000S-1300S	4776650
<b>35133</b>	Tubo flessibile adattabile a rif. orig. Fiat 5112544	Adattabile			5112544
<b>28407</b>	Tubo flessibile per martinetto supplementare per sollevatore idraulico, adattabile a rif. orig. Fiat 5126672	Adattabile			44016249, 5115845, 5126672
<b>28423</b>	Tubo flessibile adattabile a rif. orig. Fiat 5181928	Adattabile			5181928
<b>19077</b>	Tubo mandata adattabile a rif. Orig. Fiat 5131159	Adattabile			5131159
<b>28427</b>	Tubo adattabile a rif. Orig. Fiat	Adattabile			5166515
<b>19079</b>	Tubo rigido adattabile a rif. orig. Fiat 4773064	Adattabile			4773064
<b>19078R</b>	Tubo rigido adattabile a rif. orig. Fiat 5141722	Adattabile			5141722
<b>28406R</b>	Tubo flessibile adattabile a rif. Orig. Fiat 5126671	Adattabile			5126671, 5138783
<b>35131</b>	Tubo adattabile a rif. Orig. Fiat 4965382	Adattabile			4965382
<b>28233</b>	Tubo flessibile adattabile a Fiat rif. orig. 4777224	Adattabile			<b>NEW HOLLAND</b>
<b>NH5109872</b>	Tubo rigido originale Fiat rif. 5109872	Originale	5109872		
<b>NH98419863</b>	Tubo rigido originale Fiat rif. 98419863	Originale	98419863		

**VALVOLE ORIGINALI E ADATTABILI**
*VANNES ADAPTABLES ET ORIGINALES*
*ADAPTABLE AND ORIGINAL VALVES*
*VENTILE ADAPTABLE UND ORIGINAL*
*VALVULAS ADAPTABLES Y ORIGINALES*

Art./Ref.	Descrizione estesa/Extended Description	Tipo/Type	Note/Notes	Brand	Applicazione/Application	Rif. Orig./Orig. Ref.
<b>28049</b>	Valvola di scarico per comando di distribuzione adattabile a rif. orig. Fiat 4658055	Adattabile		<b>FIAT</b>	980-1000S-1180-1280-1380	4658055
<b>28051</b>	Valvola adattabile rif. orig. Fiat 4797186	Adattabile			4797186	
<b>27699R</b>	Valvola adattabile rif. orig. Fiat 5157483	Adattabile			5157483	
<b>NH5196874</b>	Elettrovalvola originale Fiat rif. 5196874	Originale		<b>NEW HOLLAND</b>		5196874
<b>NH86017919</b>	Valvola originale Fiat rif. 86017919	Originale			86017919	
<b>NH5169834</b>	Valvola originale Fiat rif. 5169834	Originale			5169834	
<b>41533</b>	Valvola di scarico per testata motore adattabile a rif. orig. Ford 81843654	Adattabile	0,76 mm	<b>FORD</b>		81843654, 87800339, D3NN6505D
<b>41534</b>	Valvola di scarico adattabile a rif. orig. Ford 87800340	Adattabile	STD		87800340, D8NN 6505AA	
<b>41538</b>	Valvola di aspirazione adattabile a rif. orig. Ford 87800386	Adattabile	STD		4830,5030,6810, 7000,7410, 7600, 7610,7700,7710	87800386, D8NN6507AB

Art./Ref.	Descrizione estesa/Extended Description	Tipo/Type	Note/Notes	Brand	Applicazione/Application	Rif. Orig./Orig. Ref.
41529	Valvola di aspirazione adattabile a rif. orig. Ford 87800347	Adattabile	0,76 mm	FORD	3910H,4130H, 3930H, 4610H, 550,555,555A/B, 7810,7910,8210, 8530,8700, TW 5,10	87800347, D3NN6507D
41531	Valvola di scarico adattabile a rif. orig. Ford 81843652	Adattabile	0,076 mm		2000, 2310, 2600, 2610, 2810, 2910, 3000, 3055,3230, 3430, 3600, 3900, 3910, 3930, 4000, 4100, 4110, 4130, 4600, 4610	81843652, D3NN6505B
41526	Valvola di aspirazione adattabile a rif. orig. Ford 87800344	Adattabile	STD		2000, 2310, 2600, 2610, 2810,, 2310, 2810, 2610, 2910, 3610, 2910, 3000, 3055, 3230, 3430, 3600, 3900, 3910, 3930, 4000, 3910, 4110, 4610, 4630, 4100, 4110, 4130, 4600, 4610	87800344, D3NN6507A
41540	Valvola di aspirazione adattabile a rif. orig. Ford 87800388	Adattabile	0,38 mm		8630, 8730, 8830, 9000, 9200,, 9600, 9700, TW 15, 20, 25, 30, 35	D8NN6507CA
42736	Valvola di controllo sollevatore idraulico Ø 25,425 mm adattabile a rif. orig. Ford 81819043	Adattabile			2000, 3000, 3055, 4000, 5000, 5600, 5700, 6600, 6700, 7000, 7600, 7700	81819032, 81819043, C7NN481G, C7NN488N
41532	Valvola di scarico adattabile a rif. orig. Ford 81843653	Adattabile	0,38 mm		5000,5600,5700	81843653, 87800338, D3NN6505C
41541	Valvola di aspirazione adattabile a rif. orig. Ford 87800389	Adattabile	0,76 mm		4830, 5030, 6810, 7000, 7410, 7600, 7610, 7700, 7710, 8630, 8730, 8830, 9000, 9200, 9600, 9700, TW 15, 20, 25, 30, 35	87800389, D8NN6507DA
41527	Valvola di aspirazione adattabile a rif. orig. Ford 87800345	Adattabile	0,076 mm		2000,2310,2600, 2610,2810,2910, 3000,3055,3230, 3430,3600,3900, 3910,3930,4000, 4100,4110,4130, 4600,4610	87800345, D3NN6507B
40221	Valvola di scarico adattabile a rif. orig. Ford 81717764	Adattabile			3.144, A3.152	81717764
41530	Valvola di scarico adattabile a rif. orig. Ford 81843651	Adattabile	STD		2000, 2310, 2600, 2610, 2810,, 2910, 3000, 3055, 3230, 3430, 3600, 3900, 3910, 3930, 4000, 4100, 4110, 4130, 4600, 4610, 4130H, 4610H, 5000,5600, 5700, 8000, 8200,, 8600, 550, 555, 555A/B, 3910H	81843651, D3556505A
41537	Valvola di scarico adattabile a rif. orig. Ford 87800343	Adattabile	0,76 mm		7810,7910,8210, 8530,8700, 8630, 8730, 8830, 9000, 9200,, 9600, 9700, 9700, TW 15, 20, TW 25, 30, 35, TW 5,10, 3930H	87800343, D8NN6505DA
41528	Valvola di aspirazione adattabile a rif. orig. Ford 87800346	Adattabile	0,38 mm		5000,5600,5700, 5110,5610,5900, 6410, 6600,, 6610, 6700, 6710	87800346, 87802255, D3NN6507C
41539	Valvola di aspirazione adattabile a rif. orig. Ford 87800387	Adattabile	0,076 mm		4830, 5030, 6810, 7000, 7410, 7600, 7610, 7700, 7710	87800387, D8NN6507BA
41535	Valvola di scarico adattabile a rif. orig. Ford 87800341	Adattabile	0,076 mm - Verde		4830, 5030, 6810, 7000, 7410, 5110, 5610, 5900, 6410, 6600, 6610, 6700, 6710, 7600, 7610, 7700, 7710	87800341, D8NN 6505BA
40251	Valvola di scarico adattabile a rif. orig. Massey Ferguson 741937M1	Adattabile			LANDINI	6840, 6870, 6880, 7500, 7550, 7830, 7860, 7870, 7880, 8000DT, 8500, 8550, 8830, 8860, 8870, 8880, ADVANTAGE CAB E F.S:85, BLIZZARD:65, BLIZZARD:75, BLIZZARD:85, CINGOLATI:C7800, FRUTTETI 530 F/L/V:8530, FRUTTETI 560 F/L/V:8560, TREKKER :CF70, TREKKER :CF75
40252	Valvola di scarico adattabile a rif. orig. Massey Ferguson 741938M1	Adattabile		6840, 6870, 6880, 7500, 7550, 7830, 7860, 7870, 7880, 8000DT, 8500, 8550, 8830, 8860, 8870, 8880, ADVANTAGE CAB E F.S:85, BLIZZARD:65, BLIZZARD:75, BLIZZARD:85, CINGOLATI:C7800, FRUTTETI 530 F/L/V:8530, FRUTTETI 560 F/L/V:8560, TREKKER :CF70, TREKKER :CF75		
40247	Valvola d'aspirazione adattabile a rif. orig. Massey Ferguson 736812M1	Adattabile	0,076 mm	6840, 6870, 6880, 7500, 7550, 7830, 7860, 7870, 7880, 8000DT, 8500, 8550, 8830, 8860, 8870, 8880, ADVANTAGE CAB E F.S:85, BLIZZARD:65, BLIZZARD:75, BLIZZARD:85, CINGOLATI:C6830, CINGOLATI:C7800, FRUTTETI 530 F/L/V:8530, FRUTTETI 560 F/L/V:8560, TREKKER :CF70, TREKKER :CF75, TREKKER:CF85		



Art./Ref.	Descrizione estesa/Extended Description	Tipo/Type	Note/Notes	Brand	Applicazione/Application	Rif. Orig./Orig. Ref.
<b>40230</b>	Valvola adattabile a rif. Orig. Massey Ferguson 3637616M1	Adattabile		<b>MASSEY FERGUSON</b>		3637616M1
<b>41751</b>	Valvola di pressione per pompa idraulica adattabile a rif. orig. Massey Ferguson 883402M92		2500 - 3000 psi, colore giallo		135, 165, 175, 178	883402M92
<b>41727</b>	Kit corpo e valvole per pompa idraulica adattabile a varie applicazioni. Formato da 1pz. 897491M1 + 1pz. 830997M91 + 2pz. 181999M1	Adattabile	Include 1pz 897491M1 + 1pz 830997M91 + 1pz 181999M1		135, 165, 175, 178	
<b>41752</b>	Valvola di pressione per pompa idraulica adattabile a rif. orig. Massey Ferguson 884747M92. Colore nero.	Adattabile	2700 - 3200 psi, colore nero		265, 275, 285, 290, 298, 340, 340, 342, 350, 352, 355, 362, 365, 375, 390, 390T	884747M92
<b>41753</b>	Valvola di pressione per pompa idraulica adattabile a rif. orig. Massey Ferguson 3401834M91	Adattabile	Per pompa alta portata - pompa intermedia presa di forza 2 velocità			3401834M91
<b>41720</b>	Kit valvole e anelli adattabile a Massey Ferguson, tipo pompa MK I	Adattabile	Pompa MK I		155, 165, 168, 175, 178, 185, 188, 230, 240, 250, 265, 275, 285, 290, 298, 340, 342, 350, 352, 355, 360, 362, 365, 372, 375, 4255, 4260, 4265, 4270, 565, 575, 590, 595, 675, 690, 698, 698T, 699, 1080, 1200, FE35, 35, 65, 135, 148, 150	
<b>11927</b>	Corpo portavalvole pompa idraulica, adattabile a rif. orig. Massey Ferguson 184471M1	Adattabile	Foro per pistone 23,1 mm		MF35,35, 65, 765	184471M1
<b>41729</b>	Kit corpo e valvole per pompa idraulica adattabile a Massey Ferguson, tipo pompa MK II. Kit formato da 1pz. 888702M3 + 1pz. 830997M91 + 2pz. 888700M1	Adattabile	Pompa MK II - Composto da rif. orig. 1pz 888702M3 + 1pz 830997M91 + 2pz 888700M1		1200, 135, 148, 155, 158, 165	
<b>VO.010.2091.0</b>	Valvola R 134 originale Same rif. 0.010.2091.0	Originale		<b>SAME</b>		0.010.2091.0

**MISCELLANEA RICAMBI ADATTABILI E ORIGINALI FIAT / FORD / NEW HOLLAND**

PIECES DE RECHANGE DIVERSES ORIGINAL ET ADAPTABLE FIAT / FORD / NEW HOLLAND  
 MISCELLANEOUS SPARE PARTS ORIGINAL AND ADAPTABLE FIAT / FORD / NEW HOLLAND  
 VERSCHIEDENE ERSATZTEILE ORIGINAL UND PASSEND ZU FIAT / FORD / NEW HOLLAND  
 REPUESTOS MISCELÁNEOS ORIGINAL Y ADAPTABLE FIAT / FORD / NEW HOLLAND

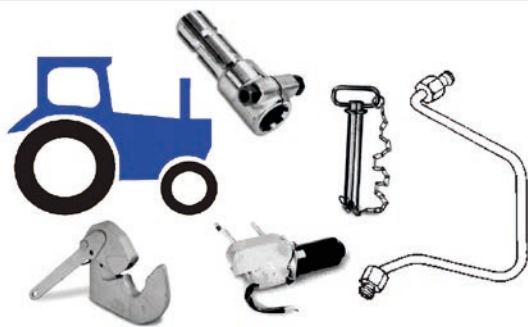

Art./Ref.	Descrizione estesa/Extended Description	Tipo/Type	Brand	Applicazione/Application	Rif. Orig./Orig. Ref.
<b>29873</b>	Astuccio adattabile a rif. Orig Fiat 4673598	Adattabile	<b>FIAT</b>		4673598
<b>29876</b>	Astuccio porta iniettore adattabile a rif. orig. Fiat 8813314	Adattabile		120C, 1300, 1300S, 750, 850 S DT	544398, 8813314
<b>26753</b>	Biella adattabile a rif. Orig. Fiat 5136635	Adattabile			5136635
<b>27630</b>	Borsa per utensili adattabile a rif. Orig. Fiat	Adattabile			4960158
<b>N04996121</b>	Braccio adattabile a rif. Orig. Fiat 4996121	Adattabile			4996121
<b>14940</b>	Braccio interno adattabile a rif. orig Fiat 5153530	Adattabile			5153530
<b>28503</b>	Bussola adattabile a rif. Orig. Fiat 4997348	Adattabile		TN55S, TN65S, TN75S, 45.66DT, 50.66DT, 55.66SDT,, 56.66SDT, G210, G240, 8870, 8970, TL70, TL80, TL90, TL100, TN55, TN55D, TN65D, TN70, TN65F, TN70F, TN75F, TN80F, TN70D, TN75, TN75D, TN90F, TN95F	4997348
<b>27495</b>	Cerniera adattabile a rif. orig. Fiat 5125178	Adattabile			5125178
<b>27629</b>	Chiave adattabile a rif. Orig. Fiat 5121429	Adattabile			5121429

Art./Ref.	Descrizione estesa/Extended Description	Tipo/Type	Brand	Applicazione/Application	Rif. Orig./Orig. Ref.	
16626	Collare adattabile a rif. orig. Fiat 5123751	Adattabile	FIAT		5123751	
29908	Colonetta adattabile a rif. Orig. Fiat 44013185	Adattabile				44013185
27766	Comando adattabile a rif. orig. Fiat 5178595	Adattabile				5178595
N05143958	Complemento puntone 2° categoria adattabile a rif. orig. Fiat 5143958	Adattabile			115.90R, 1180R, 130-90, 140-90, 160-90, 180.90R, 180-90, 1880R	5103426, 5143958
N044018847	Estremità destra adattabile a rif. Orig. Fiat 4401884	Adattabile				44018847
19096	Flangia adattabile a rif. orig. Fiat 5171526	Adattabile				5171526
26447	Flangia adattabile a rif. orig. Fiat 5174244	Adattabile				5174244
28520	Gabbia rulli adattabile a rif. Orig. Fiat 5124054	Adattabile				5124054
36029	Giunto adattabile a rif. Orig. Fiat 758563	Originale				758563, 89806311
26796	Ingrassatore per ponte anteriore adattabile a rif. orig. Fiat 5120532	Adattabile			90.90DT, 100.90DT, 110.90DT, 90.90DT, 100.90DT, 110.90DT, TL70-TL80-TL90-TL100, TN55-TN55D-TN65-TN65D-TN70, TN55S-TN65S-TN75S, TN65F-TN70F-TN75F-TN80F, TN70D-TN75-TN75D, TN90F-TN95F	5120532
19071	Membrana adattabile rif. orig. Fiat 4771078	Adattabile				4771078
27703	Nottolino adattabile a rif. orig. Fiat 5112851	Adattabile			130.90, 140.90, 160.90, 180.90	4997637, 5112851
15590	Pattino adattabile a rif. orig. Fiat 4970047	Adattabile				4970047, 5160733
28511	Piastrina adattabile a rif. orig. Fiat 4997202	Adattabile			L60, L65, L75, L85, L95, TL70, TL80, TL90, TL100, TN, TND, TNS, TNF	4997202
29180	Pomello adattabile a rif. orig. Fiat 5141548	Adattabile				5141548
27412	Portapolverizzatore adattabile a rif. orig. Fiat 476083	Adattabile				476083
14964	Prigioniero adattabile a rif. orig. Fiat 4720313	Adattabile				4720313, 4739104, 8826974, 9926975
28470	Prigioniero adattabile a rif. orig. Fiat 4754566	Adattabile				13449520, 13449521, 4754566
17157	Proiettore adattabile a rif. Orig. Fiat 434926	Adattabile				434926, 80434926
19278	Puntale adattabile a rif. Orig. Fiat 5126037	Adattabile				5126037
27552	Raccordo adattabile a rif. Orig. Fiat 5156052	Adattabile				5156052
27551	RACCORDO ORIENTABILE ADATTABILE A 4722869	Adattabile			446, 480, 500, 540, 600, 605C, 640, 666, 670, 680	4722869
19298	Raccordo adattabile a rif. orig. Fiat 5141862	Adattabile				5141862
26892	Raccordo adattabile a rif. orig. Fiat 5155665	Adattabile				5155665
28451	Raccordo idraulico adattabile a rif. orig. Fiat 4623038	Adattabile			1380DT	4623038
27668	Raccordo pompa adattabile a rif. orig. Fiat 4952685	Adattabile				4952685
19279	Raccordo tubazioni sollevatore idraulico adattabile a rif. orig. Fiat 5158802	Adattabile			1300S, 1300DTS, M100, M115, M135, M160	5158802
26961	Relè adattabile a rif. orig. Fiat 5186264	Adattabile			TND, TNS	5186264
N05164279	Ruota tendicingolo adattabile a rif. orig. Fiat 5164279	Adattabile				5164279
14445	Scodellino adattabile a rif. orig. Fiat 5153938	Adattabile			115.90-130.90-140.90-160.90, 180.90	5138220, 5150557, 5153938
35079	Scontrino adattabile a rif. Orig. Fiat 5154755	Adattabile				5154755
16832	Scontrino destro adattabile a rif. Orig. Fiat 5108399	Adattabile				5108399
16831	Scontrino sinistro adattabile a rif. Orig. Fiat 5108398	Adattabile				5108398
19072	Sfiatatoio motore adattabile a rif. orig. Fiat 4816603	Adattabile				4816603
28105	Sfiatatoio per ponte anteriore adattabile a rif. orig. Fiat 5101814	Adattabile			90.90DT-100.90DT-110.90DT	4999444, 5101814
16464	Spina di registrazione filettata adattabile a rif. orig. Fiat 5109695	Adattabile				5109695
16466	Spina elastica rif. orig. Fiat 4991719	Adattabile			1180, 1280, 1380, 1580, 1880, L60, L65, L75, L85, L95, TL70, TL80, TL90, TL100	4991719
26495	Spingidisco adattabile a rif. orig. Fiat 5119533	Adattabile				5119533
27620	Staffa adattabile a rif. Orig. Fiat 5184716	Adattabile				5184716
26866	Staffetta fissaggio a rif. orig. Fiat 5133366	Adattabile				5133366, 5138353

Art./Ref.	Descrizione estesa/Extended Description	Tipo/Type	Brand	Applicazione/Application	Rif. Orig./Orig. Ref.
<b>29187R</b>	Targa adattabile a rif. Orig. 5158917	Adattabile	<b>FIAT</b>		5158917
<b>27934</b>	Targhetta adattabile a rif. Orig. Fiat 5178779	Adattabile			5178779
<b>N05104059</b>	Tassello adattabile a rif. Orig. Fiat 5104059	Adattabile			5104059
<b>43007</b>	Fanale posteriore sinistro adattabile a rif. orig. Ford 89847115	Adattabile	<b>FIAT - FORD</b>	8670, 8770, 8870, 8970	86500254, 89847115
<b>NH87440439</b>	Solenoide originale Fiat rif. 84173878	Originale	<b>FIAT - NEW HOLLAND</b>		87440439, 87440439
<b>22423</b>	Tenditore completo adattabile a rif. orig. Fiat 81813318	Adattabile	<b>FORD</b>	3230, 3430, 3900, 3910, 3930, 4000, 4100, 4110, 4130, 4600, 4610, 4630, 4830, 5030	81813318, 81813318, CFPND936A
<b>21688</b>	Biella a stantuffo adattabile a rif. orig. Fiat 83906785	Adattabile		2000, 2600, 2310, 2810, 2610, 2910, 3000, 3600, 3900, 3610,, 3910, 3230, 3430, 3930, 4000, 3910H, 4610H, 3930H, 4130H, 4100, 4600, 4110, 4610, 4130, 4630, 5000,5600, 5700, 6600, 6700, 5110, 5610, 5900 6410, 6610, 550, 555/A/B, 6710, 7810, 7910, 8000, 8200, 8210, 8530, 8600, 8700, TWS, TW10	83906785
<b>42305</b>	Kit revisione cilindro per comando frizione idraulica adattabile a rif. orig. Fiat/Ford 81873388	Adattabile		5640, 6640, 7740, 7840, 8240,, 8340, TS 80, 90, 100, TS 110, 115	81873388
<b>42923</b>	Martinetto per finestrino laterale sinistro, parte posteriore, adattabile a rif. orig. Ford 83917055	Adattabile		5110, 5610, 5900, 6610, 6710, 5110, 5610, 5900, 6610, 6710,, 7610, 7710, 7910, 8210,, TW 5, 15, 25, 35	83917055, D7NN94303N05C
<b>18182</b>	Bocchettone adattabile a Fiat rif. orig. 4617973	Adattabile	<b>LAVERDA - FIAT</b>	1000 DTS, 1180, 130-90DT,140-90DT,72-93DT, 1380 DT, 250, 3010S,5010S,4010S, 55-66,80-66S,65-66,90-90DT, 55-90DT,55-66LP,72-94,70-76LP, 60-66,65-90DT,65-46DT,70-90DT, 60-66DT,80-88DT,70-88,88-93, 600, 605C, 640, 65-56DT,65-56,65-46,65-93DT, 65-66DT,55-66DT,80-66S,80-90DT, 65-88DT,82-94,65-66S,65-94, 65-93,115-90,7076LPDT,82-93, 666, 670, 680, 70-56,130-90,65-66SDT,60-90DT, 70-66LPDT,70-66,80-66S,70-66DT, 70-66SDT,70-66,70-66LP,70-66V, 70-66SDT,70-66DT,70-66SDT, 70-76F,70-56DT,88-94,140-90, 72-93,80-66DT,70-66S,82-93DT, 72-94DT,80-88,60-90,80-66, 80-66HC,50-66DTP,65-94DT, 80-76F,65-88,65-90,115-90DT, 80-76FDT,140-90DT,70-76V, 82-94DT,70-90,70-88DT,70-76FDT, 85-90,55-90,80-66FDT,88-94, 88-93DT,80-66S HC,80-66SDT, 90-90,80-66F,85-90DT,80-90	4617973, 9918110, 4617973
<b>NH5177861</b>	Blocchetto originale Fiat rif. 5177861	Originale	<b>NEW HOLLAND</b>		5177861
<b>NH582018R1</b>	Blocchetto originale Fiat rif. 582018R1	Originale		582018R1	
<b>NH1322573C1</b>	Camma originale Fiat rif. 1322573C1	Originale		1322573C1	
<b>NH44903290</b>	Catena originale Fiat rif. 44903290	Originale		44903290	
<b>NH87318316</b>	Coltello originale Fiat rif. 87318316	Originale		87318316	
<b>NH5146830</b>	Comando originale Fiat rif. 5146830	Originale		5146830	
<b>NH71479577</b>	Corredo originale Fiat - CNH rif. 71479577	Originale		71479577	
<b>NH9970369</b>	Corredo guarnizioni per idroguda originale New Holland rif. 9970369	Originale		9970369	
<b>NH5174734</b>	Distributore originale Fiat rif. 174734	Originale		5174734	
<b>NH5133857</b>	Estremità originale Fiat rif. 5133857	Originale		5133857	
<b>NH83936827</b>	Flangia originale Fiat rif. 83936827	Originale		83936827	
<b>NH5124433</b>	Gancio traino originale Fiat rif. 5124433	Originale		5124433	
<b>NH9962254</b>	Giunto doppio originale Fiat rif. 9962254	Originale		9962254	
<b>NH193175C2</b>	Guida originale fiat rif. 193175C2	Originale		193175C2	
<b>42260</b>	Kit riparazione per pompa acqua adattabile a rif. orig. CNH 81869958	Adattabile		5640, 6640, 7740, 7840, 8240, 8340, TS90, TS100, TS110, TS115	81869958, 81869958
<b>NH9966378</b>	Kit rivestimento interno per cabina, originale New Holland rif. 9966378	Originale			9966378
<b>NH5104426</b>	Manicotto originale Fiat rif. 5104426	Originale			5104426
<b>NH183333C1</b>	Mozzo originale fiat rif. 183333C1	Originale		183333C1	
<b>NH4996776</b>	Mozzo originale fiat rif. 4996776	Originale		4996776	
<b>NH82007586</b>	Pannello originale Fiat rif. 82007586	Originale		82007586	
<b>NH44907762</b>	Piantone guida originale Fiat rif. 44907762	Originale		44907762	
<b>NH5117038</b>	Piastra originale Fiat rif. 5117038	Originale		5117038	

Art./Ref.	Descrizione estesa/Extended Description	Tipo/Type	Brand	Applicazione/Application	Rif. Orig./Orig. Ref.
NH83913005	Piastra originale Fiat rif. 83913005	Originale	NEW HOLLAND		83913005
NH87605245	Potenziometro originale Fiat rif. 87605245	Originale			87605245
NH9821734	Potenziometro originale Fiat rif. 9821734	Originale			9821734
NH47134706R	Proiettore originale Fiat rif. 47134706	Originale			47134706
NH5122003	Protezione originale Fiat rif. 5122003	Originale			5122003
NH82021163	Radar originale Fiat rif. 82021163	Originale			82021163
NH9960554	Sedile guidatore originale Fiat rif. 9960554	Originale			9960554
NH9971885	Solenoido originale Fiat rif. 9971885	Originale			9971885
NH320808450	Spazzola originale Fiat rif. 320808450	Originale			320808450
NH87840271	Turbo compressore originale Fiat rif. 87840271	Originale			87840271
31252	Kit catene Flexon per insilatrice	Originale			

**MISCELLANEA RICAMBI ADATTABILI E ORIGINALI LANDINI / MASSEY FERGUSON / PERKINS**

PIECES DE RECHANGE DIVERSES ORIGINAL ET ADAPTABLE LANDINI / MASSEY FERGUSON / PERKINS

MISCELLANEOUS SPARE PARTS ORIGINAL AND ADAPTABLE LANDINI / MASSEY FERGUSON / PERKINS

VERSCHIEDENE ERSATZTEILE ORIGINAL UND PASSEND ZU LANDINI / MASSEY FERGUSON / PERKINS

REPUESTOS MISCELÁNEOS ORIGINAL Y ADAPTABLE LANDINI / MASSEY FERGUSON / PERKINS



Art./Ref.	Descrizione estesa/Extended Description	Tipo/Type	Brand	Applicazione/Application	Rif. Orig./Orig. Ref.	
LN3557546M91	Aletta originale Landini rif. 3557546M91	Originale	LANDINI		3557546M91	
75915	Attacco rapido adattabile a rif.orig. Landini 3552890M91	Adattabile		LANDPOWER 115, LANDPOWER 125, LANDPOWER 130, LANDPOWER 135, LANDPOWER 145, LANDPOWER 165, LANDPOWER 185, LEGEND 105, LEGEND 115, LEGEND 130, LEGEND 145, LEGEND 165, LEGEND N/G 115, LEGEND N/G 120, LEGEND N/G 130, LEGEND N/G 140, LEGEND N/G TDI 125, LEGEND N/G TDI 130, LEGEND N/G TDI 135, LEGEND N/G TDI 145, LEGEND N/G TDI 160, LEGEND N/G TDI 165, LEGEND N/G TDI 185, MYTHOS 100, MYTHOS 110, MYTHOS 115, MYTHOS 90, POWERMASTER 180, POWERMASTER 200, POWERMASTER 220, VISION 100, VISION 105, VISION 80, VISION 85, VISION 90, VISION 95	3552890M91	
LN974552M1	Camma originale Landini rif. 974552M1	Originale		974552M1		
LN1824704M4	Carcassa originale Landini rif. 1824704M4	Originale		1824704M4		
LN3549082M99	Corpo originale Landini rif. 3549082M99	Originale		3549082M99		
LN3660138M1	Griglia anticottatura per marmitta, originale Landini rif. 3660138M1	Originale		3660138M1		
LN3910292M91	Kit settore originale Landini rif. 3910292M91	Originale		3910292M91		
LN3533205M92	Puntone originale Landini rif. 3533205M92	Originale		3533205M92		
11920	Attuatore per impianto frenante adattabile a rif. orig. Massey Ferguson 764805M92. Misura 180mm, tipo secco	Adattabile		LANDINI MASSEY FERGUSON	8000/DT, 8000R, 9500, 65, 155, 158, 165, 175, 178, 765	764805M92, 764805M92

Art./Ref.	Descrizione estesa/ Extended Description	Tipo/Type	Brand	Applicazione/Application	Rif. Orig./Orig. Ref.
<b>40299</b>	Bilanciatore adattabile a rif. orig. Massey Ferguson 3637352M91	Adattabile	<b>PERKINS MASSEY FERGUSON</b>	390, 590, 690, 3060, 4225,	3637352M91, 4111K051, 4111K051
<b>11887</b>	Assale anteriore adattabile a rif. Orig. Massey Ferguson 897625	Adattabile	<b>MASSEY FERGUSON</b>	675, 690	897625, 897625M93
<b>41983</b>	Chiave interruttore adattabile a rif. orig. Maseey Ferguson 3813361M1	Adattabile		3813361M1	
<b>41116</b>	Cilindretto sinistro per impianto frenante adattabile a rif. orig. Massey Ferguson 3477380M92	Adattabile		340, 342, 350, 352, 355, 360, 362, 365, 372, 375, 382, 390, 390T, 398	3477380M93
<b>11933</b>	Cuscinetto anteriore pompa idraulica adattabile a rif. orig. Massey Ferguson 180924M2	Adattabile		1250, 35, 65, 133, 135, 140, 148,, 698T, 699, 765, 1080, 1200,	180924M2
<b>40986</b>	Fermi per scatola differenziale adattabili a rif. orig. Massey Ferguson 831485M1	Adattabile	<b>MASSEY FERGUSON</b>	35, 135, 148, 155, 158, 165,, 690, 698, 699, 1200, 1250	831485M1
<b>MF532898M1</b>	Manicotto calettato originale Massey Ferguson rif. 532898M1	Adattabile		532898M1	
<b>11742R</b>	Riduttore epicicloidale adattabile a rif. Orig. Massey Ferguson 827719M91	Adattabile		827719M91	
<b>41884</b>	Terzo punto cat. 2/2 adattabile a rif. orig. Massey Ferguson 1660050M91. Lunghezza da min. 635mm a max. 870mm	Adattabile		375, 390, 398, 399, 590, 595, 675, 690, 698, 698T, 699	1660050M91
<b>11275</b>	Kit tubi iniettori adattabile a rif. orig. Massey Ferguson 35343025/26/27/28	Adattabile	<b>LANDINI - PERKINS - MASSEY FERGUSON</b>	6530F/L/V,6830,7530F/L,7830, 6560F/L/V,6860,7560F/L,7860, 7000SPECIAL,8000DT,8000R, 7860HC,8560F/L,8860,8860HC, 8530F/L,8830,6840,6550,7550, 8550,6500,7500,8500,7505, ADVANTAGE 65F/FP/GE/GT/GTP/L, ADVANTAGE 75F/FP/GE/GT/GTP/L, ADVANTAGE 85F/FP/GE/GT/GTP/L, BLIZZARD 65/75/85, C6500,C6830,C7800,C7830,C8860, CF85, TREKKER C75/C85/CF65/CF70/CF75, VIGNETI 65V/75V, 168, 174,184,194,273,274,283,284, 175, 178, 185, 188, 265, 275, 285,293,294,367,373,374,376, 290, 3050, 3060, 362, 365, 372, 375, 377,382,383,384,393,394,396, 390, 397,3220,3225, 565, 575, 590, 675, 690, A4.236,A4.248,A4.212,AT4.236	35343025+35343026+35343027+353, 6870,7870,8870, 35343025, 35343025+35343026+35343027+353, 35343026, 35343027, 35354266, 35354267, 35354293, 735099M91, 735100M91, 735101M91, 744512M91, 744513M91, 744514M91, 35343025+35343026+35343027+353
<b>43251</b>	Manicotto Z = 6, adattabile a rif. orig. Landini 1425213M2	Adattabile	<b>LANDINI - MASSEY FERGUSON</b>	12500, 14500	1425213M2
<b>40212</b>	Testata motore adattabile a rif. Orig. Massey 3637388M91	Adattabile	<b>PERKINS - MASSEY FERGUSON</b>		3637388M91, ZZ80067
<b>40213</b>	Testata motore adattabile a rif. Orig. Massey 3637383M91	Adattabile	<b>PERKINS - MASSEY FERGUSON</b>		3637383M91, ZZ80024
<b>40202</b>	Complessivo bilancieri adattabile a varie applicazioni Ford	Adattabile	<b>PERKINS</b>		4115R805
<b>PK4111K059R</b>	Equilibratore adattabile a rif. Orig. Landini 4111K059	Originale		4111K059	
<b>PK4111K073</b>	Equilibratore originale Perkins rif. 4111K073	Originale		4111K073	

Art./Ref.	Descrizione estesa/ Extended Description	Tipo/Type	Brand	Applicazione/Application	Rif. Orig./Orig. Ref.
PK33811113	Guarnizione tubo carburante originale Perkins rif. 33811113	Originale	PERKINS		33811113
PK2758314R	Rinvio angolare originale Perkins rif. 2758314	Originale			2758314
PK2758346	Rinvio angolare originale Perkins rif. 2758346	Originale			2758346

**MISCELLANEA RICAMBI ADATTABILI E ORIGINALI SAME**

PIECES DE RECHANGE DIVERSES ORIGINAL ET ADAPTABLE SAME  
 MISCELLANEOUS SPARE PARTS ORIGINAL AND ADAPTABLE SAME  
 VERSCHIEDENE ERSATZTEILE ORIGINAL UND PASSEND ZU SAME  
 REPUESTOS MISCELÁNEOS ORIGINAL Y ADAPTABLE SAME

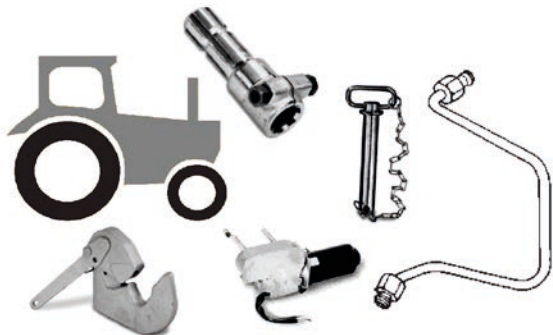

Art./Ref.	Descrizione estesa/Extended Description	Tipo/Type	Brand	Rif. Orig./Orig. Ref.
V0.010.3168.1	Ammortizzatore per sedile originale Same rif. 0.010.3168.1	Originale	SAME	0.010.3168.1
V0.9061.324.3/1	Braccio originale Same rif. 0.9061.324.3/10	Originale		0.9061.324.3/10
V04253771	Camicia di raffreddamento originale Same rif. 04253771	Originale		04253771
V0.007.1277.0/5	Coppa olio in ghisa originale Same rif. 0.007.1277.0/50	Originale		0.007.1277.0/50
V2.8019.450.1	Corpo luminoso sinistro originale Same rif. 2.8019.450.1	Originale		2.8019.450.1
V0.146.4632.4/1	Crociera cardanica originale Same rif. 0.146.4632.4/10	Originale		0.146.4632.4/10
V04439048	Kit di riparazione originale Same rif. 04439048	Originale		04439048
V0.202.3252.0/1	Manicotto originale Same rif. 0.202.3252.0/10	Originale		0.202.3252.0/10
N00.151.3622.0/	Manicotto adattabile a rif. Orig. Same 0.151.3622.0/10	Adattabile		0.151.3622.0/10
V04411182.4/10	Martinetto Ø 80 mm originale Same rif. 04411182.4/10	Originale		04411182.4/10
V2.7099.460.0	Pressostato olio motore originale Same rif. 2.7099.460.0	Originale		2.7099.460.0
V16055793	Sensore di posizione originale Same rif. 16055793	Originale		16055793
V0.010.5219.4	Stabilizzatore completo originale Same rif. 0.010.5219.4	Originale		0.010.5219.4
16000	Trasmissione flessibile lunghezza 1162 mm, adattabile a rif. orig. Same 0.264.7435.0/20	Adattabile		0.264.7435.0/20

**MISCELLANEA RICAMBI ADATTABILI E ORIGINALI A DIVERSI MARCHI**
*PIECES DE RECHANGE DIVERSES ORIGINAL ET ADAPTABLE DIFFÉRENTES MARQUES*
*MISCELLANEOUS SPARE PARTS ORIGINAL AND ADAPTABLE DIFFERENT BRANDS*
*VERSCHIEDENE ERSATZTEILE ORIGINAL UND PASSEND ZU VERSCHIEDENE MARKEN*
*REPUESTOS MISCELÁNEOS ORIGINAL Y ADAPTABLE DIFERENTES MARCAS*

Art./Ref.	Descrizione estesa/Extended Description	Tipo/Type	Brand	Rif. Orig./Orig. Ref.
<b>31263</b>	Catena laterale Felxon per inislatrice adattabile a rif. orig. Claas 912096.0	Adattabile	<b>CLAAS</b>	912096
<b>31261R</b>	Pignone motore Flexon adattabile a rif. orig. Claas 912185.0	Adattabile		912185
<b>31262R</b>	Pignone tenditore Felxon adattabile a rif. orig. Claas 912199.0	Adattabile		912199
<b>GA0506041</b>	Ago in ghisa per pressa originale Galignani rif. 0506041	Originale	<b>GALLIGNANI</b>	0506041
<b>GA603360</b>	Pattino adattabile rif. orig. 603360	Adattabile		603360
<b>JDRE212876</b>	Pressostato olio originale John Deere rif. RE212876	Originale	<b>JOHN DEERE</b>	RE212876
<b>LV311206901</b>	Coppia spranghe originale Laverda rif. 311206901	Originale	<b>LAVERDA</b>	311206901
<b>LV322702450</b>	Dente paralama originale Laverda rif. 322702450	Originale		322702450
<b>LV322843850</b>	Porta guida originale Laverda rif. 322843850	Originale		322843850
<b>28675</b>	Piastra adattabile a rif. orig. Laverda 300135128	Adattabile		300135128
<b>LV322355100</b>	Sensore originale Laverda rif. 322355100	Originale		322355100
<b>29272R</b>	Supporto adattabile rif. orig. Laverda 320726550	Adattabile		320726550
<b>LV3218524500</b>	Trave originale Laverda rif. 3218524500	Originale		3218524500